



AKTIVE MUSKELMODELLIERUNG AN DER SCHNITTSTELLE VON MEHRKÖRPER- UND KONTINUUMSMECHANIK

Jun.-Prof. Dr. Syn Schmitt ^{1,2}

schmitt@inspo.uni-stuttgart.de

Jun.-Prof. Oliver Röhrle, PhD ^{1,3}

roehrle@simtech.uni-stuttgart.de

- 1) Cluster of Excellence for Simulation Technology, Universität Stuttgart
- 2) Institut für Sport- und Bewegungswissenschaft, Universität Stuttgart
- 3) Virtual Orthopedic Lab, Biomechatronische Systeme, Fraunhofer IPA



PART I

MULTI-BODY SIMULATIONS



OUR VIEW ON THE BIOLOGICAL MOTOR

Muscle

Hill-type muscle model

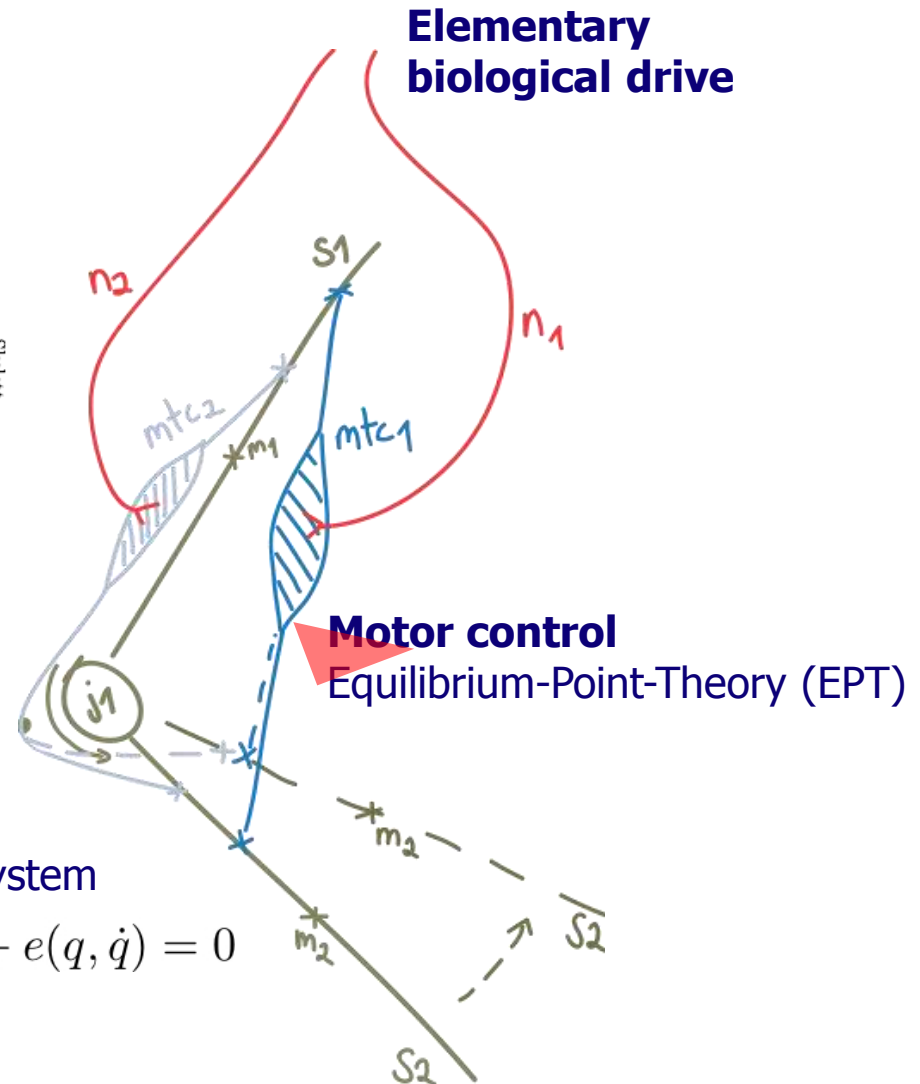
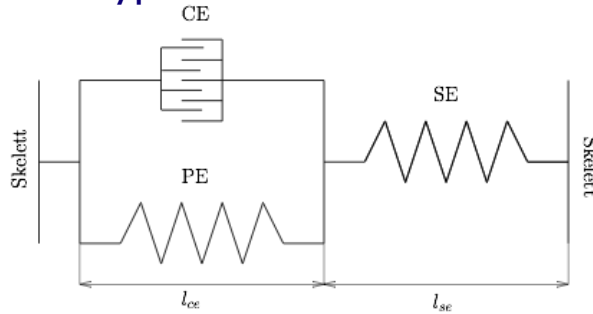

Skeletal apparatus

ODE model of the mechanical system

$$M(q)\ddot{q} + C(q)\dot{q}^2 + g(q) + R(q)f^{mtc} + e(q, \dot{q}) = 0$$

Part I
Multi-Body Model

Part II
Continuum Model

Part III
Coupled Model

Part IV
Future Potential



OUR VIEW ON THE BIOLOGICAL MOTOR

Muscle

Hill-type muscle model

Elementary biological drive

Motor control

Equilibrium-Point-Theory (EPT)

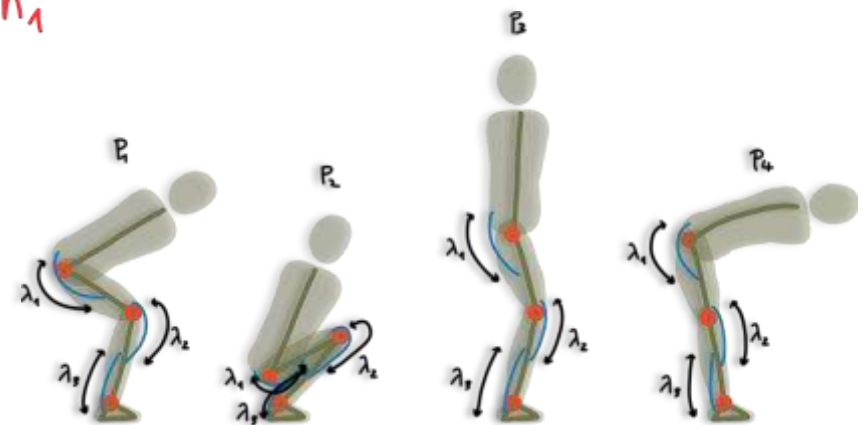
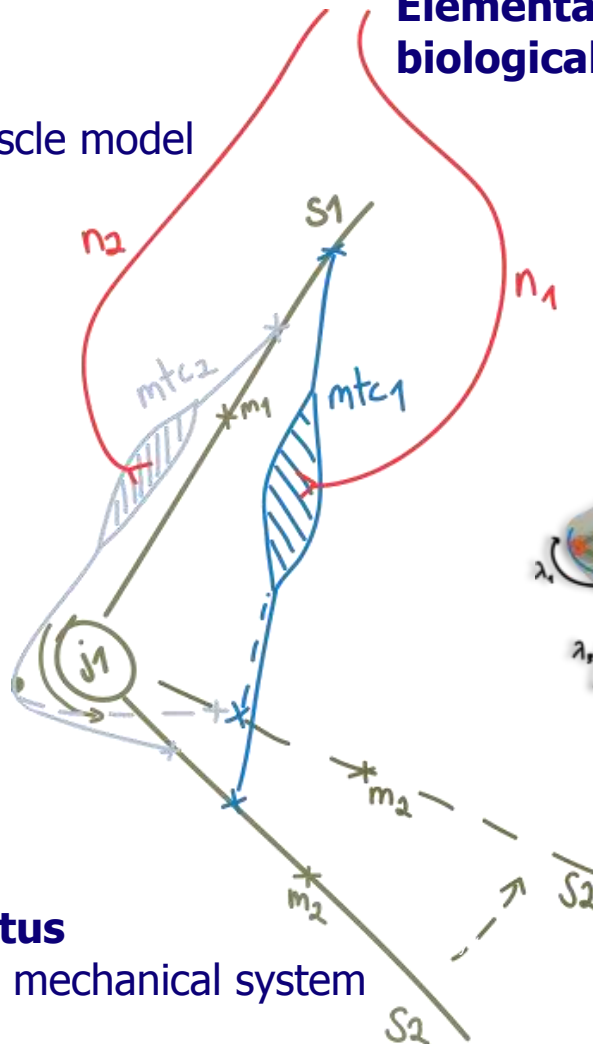

P_1	P_2	P_3	P_4
λ_1	λ_1	λ_1	λ_1
λ_2	λ_2	λ_2	λ_2
λ_3	λ_3	λ_3	λ_3

Skeletal apparatus

ODE model of the mechanical system

- Part I
Multi-Body Model
- Part II
Continuum Model
- Part III
Coupled Model
- Part IV
Future Potential



COMPUTATIONAL MOTOR CONTROL

=

multiple EBDs
(single joint drives)

+

more complex drives
(multi joint drives)

+

well tuned control
(all drives)

+

movement tasks
(daily living, ...)

+

account for disturbances
(uneven ground, impact forces, ...)

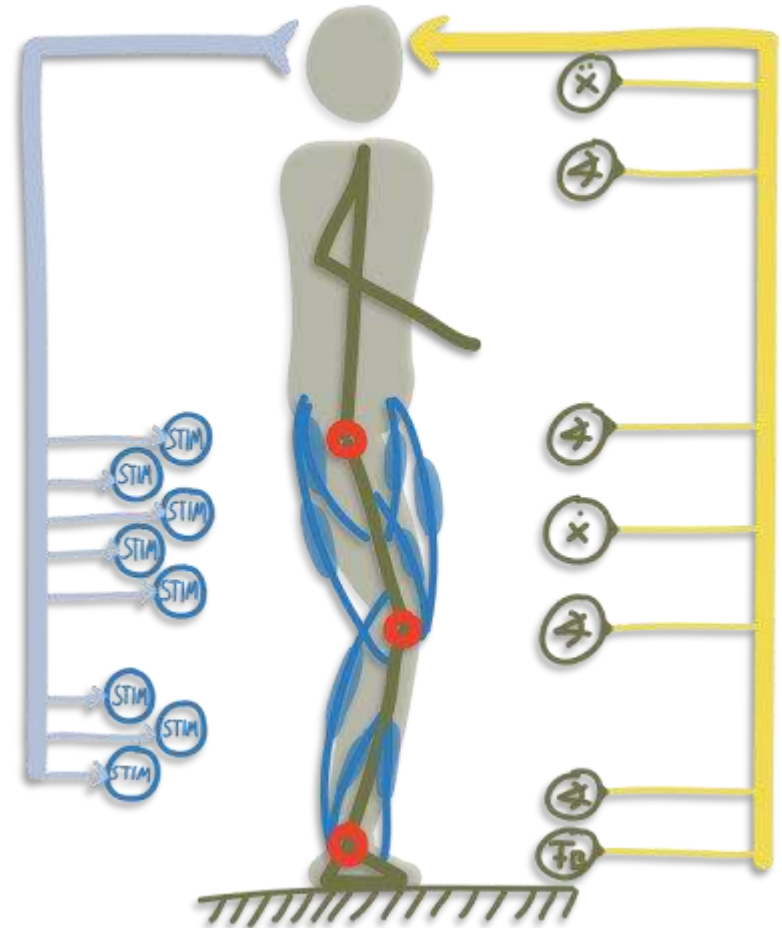

- Part I
Multi-Body Model
- Part II
Continuum Model
- Part III
Coupled Model
- Part IV
Future Potential



DETAILED LUMBAR SPINE MODEL

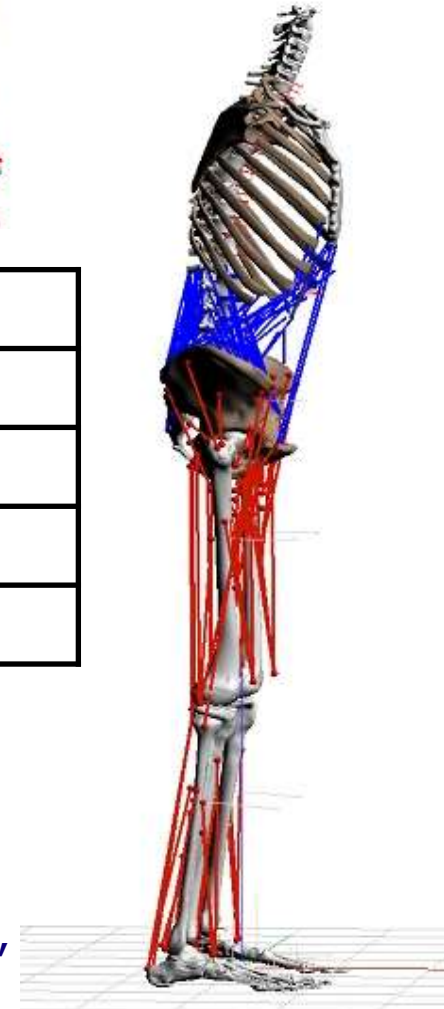
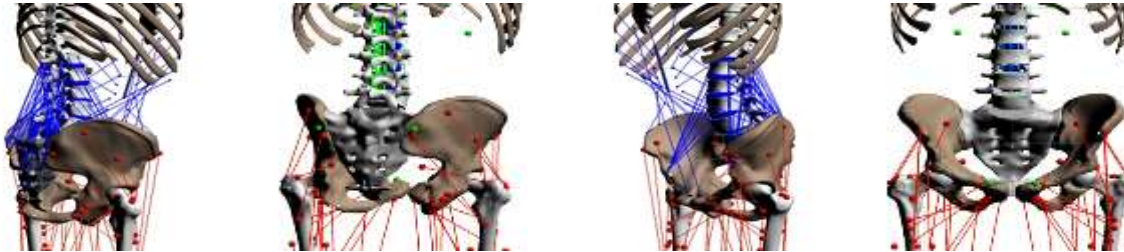

Part I
Multi-Body Model

Part II
Continuum Model

Part III
Coupled Model

Part IV
Future Potential

452	degrees of freedom
48	mechanical dofs
202	Muscle-tendon complex (active, Hill-type)
58	non-linear ligaments
5	intervertebral discs (non-linear, coupled)

Anatomy of skeleton: m, 68kg, 1,78m (NASA, 1978)

Ligaments:

Anatomy (Panjabi, 1982), physiology (Chazal, 1985)

Muscles:

Anatomy and physiology (Bogduk, 1992a,b, 1998; Hansen, 2006; Christophy, 2012)



DETAILED LUMBAR SPINE MODEL



University of Stuttgart
Germany

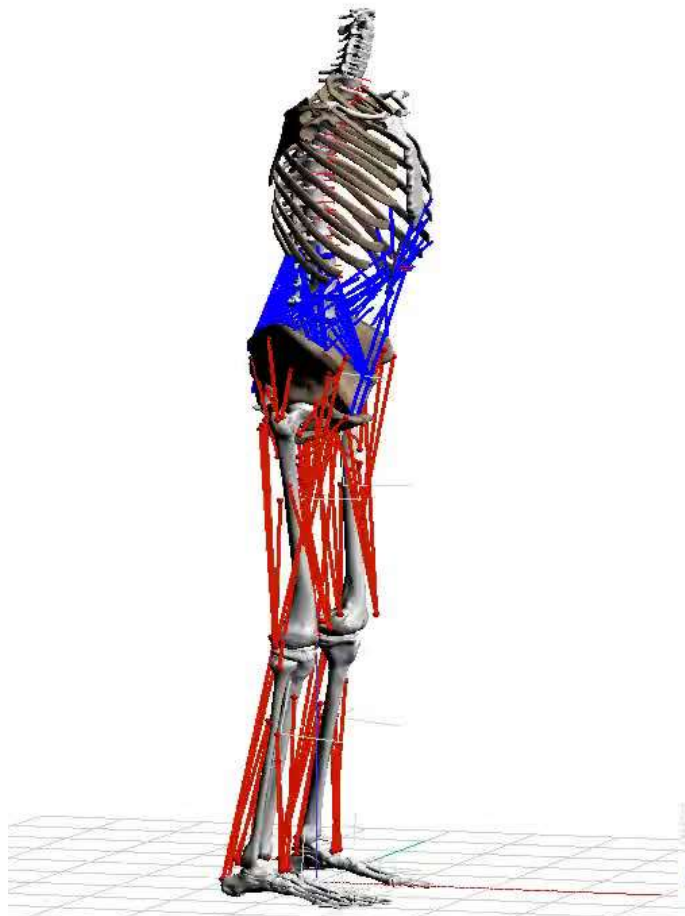

IVD Force
normal dir.

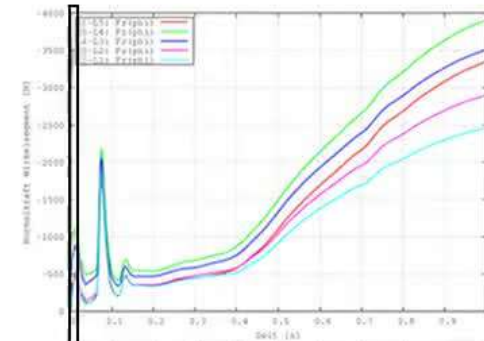

IVD Torque

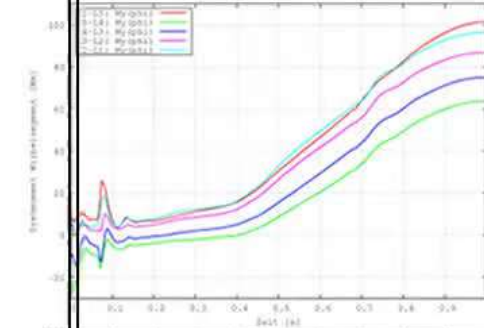

LIG Force
posterior

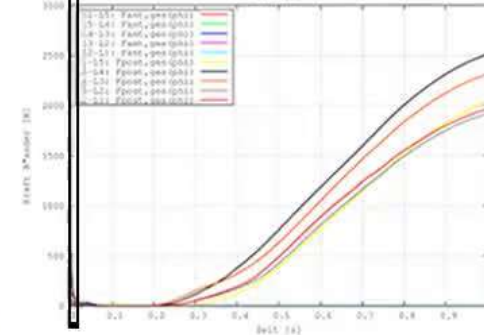

Part I
Multi-Body Model

Part II
Continuum Model

Part III
Coupled Model

Part IV
Future Potential



FUTURE DEVELOPMENT OF MULTI-BODY SIM

Biomechanics

- **Computational motor control should incorporate and evaluate muscle characteristics on control theories.**
- **The muscle model itself should account for transverse contraction and act on realistic muscle paths (via-points).**
- **The skeletal apparatus should consider realistic joint kinematics, soft tissue movement, and account for flexible bones (flexible rgb systems).**

Methods

- **Model reduction techniques should be applied to enhance multi-scale approach.**
- **Parallelisation of code should improve simulation time.**
- **User-friendly movement generation algorithms would open direct dynamics approach to engineers.**

Part I
Multi-Body Model

Part II
Continuum Model

Part III
Coupled Model

Part IV
Future Potential



PART II

CONTINUUM-MECHANICAL MODELLING



ADVANTAGES OF CONTINUUM-MECHANICAL MODELS

Lumped-parameter models of skeletal muscles crudely represent structural properties of skeletal muscle mechanics, e.g. it is not possible

- to include complex muscle fibre distributions,
- to represent the interaction with surrounding tissue, e.g. inter-muscular force transmission,
- to include local muscle activity as obtained by multi-channel EMG measurements.



Continuum-Mechanical Skeletal Muscle Model

Part I
Multi-Body Model

Part II
Continuum Model

Part III
Coupled Model

Part IV
Future Potential



COMPLEX MUSCLE FIRBE ARCHITECTURE

- Part I
Multi-Body Model
- Part II
Continuum Model
- Part III
Coupled Model
- Part IV
Future Potential

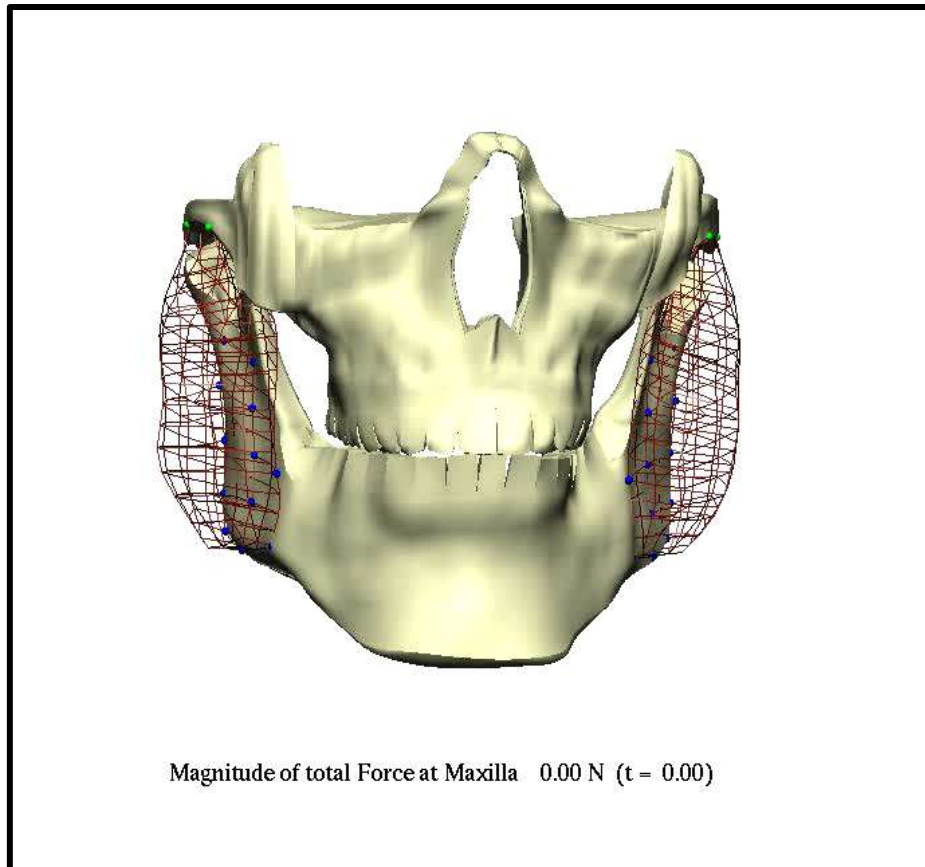

Inverse Dynamics

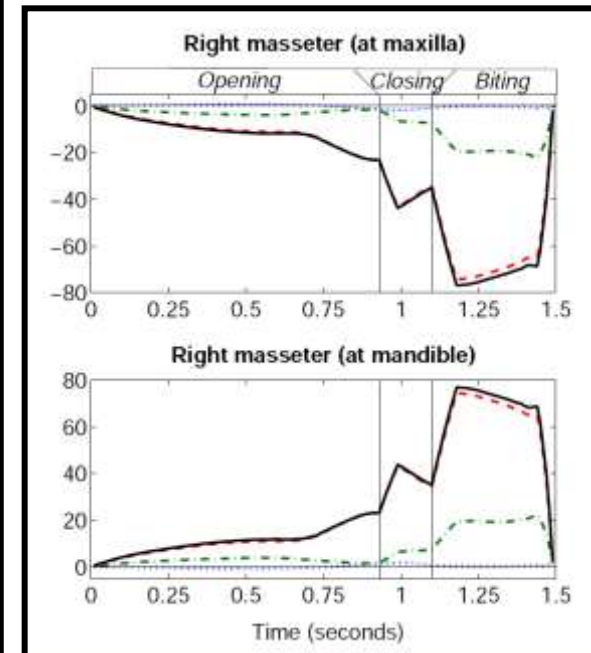



NEW/OLD MUSCLE FORCE DIRECTIONS

**1D line of action
(centreline approach)**

**Overall force derived
from the 3D model**

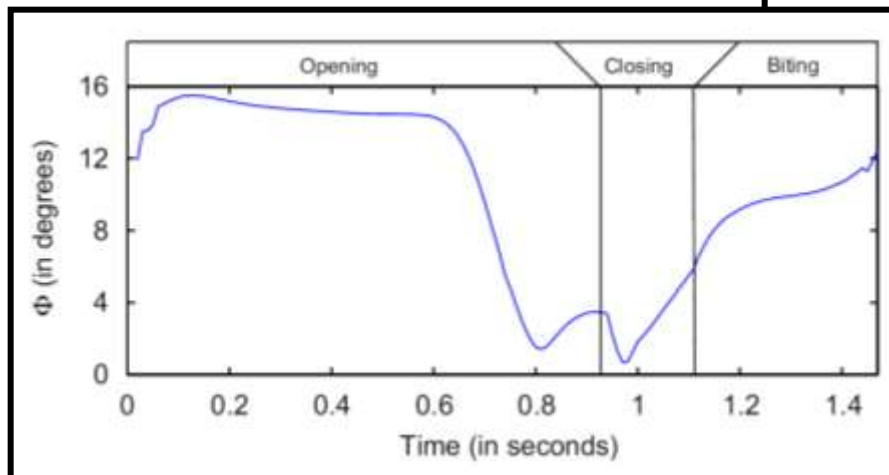
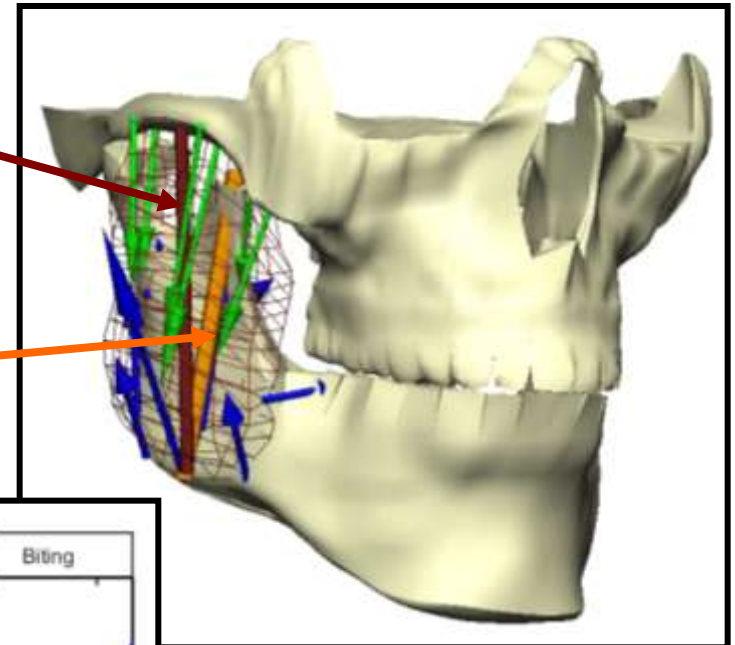

Röhrle, O. and Pullan, A.J., "Three-dimensional finite element analysis of muscle forces during mastication", *Journal of Biomechanics*, 40 (2007), pp 3363 – 3372

- Part I
Multi-Body Model
- Part II
Continuum Model
- Part III
Coupled Model
- Part IV
Future Potential



MULTI-SCALE MUSCLE MODELLING

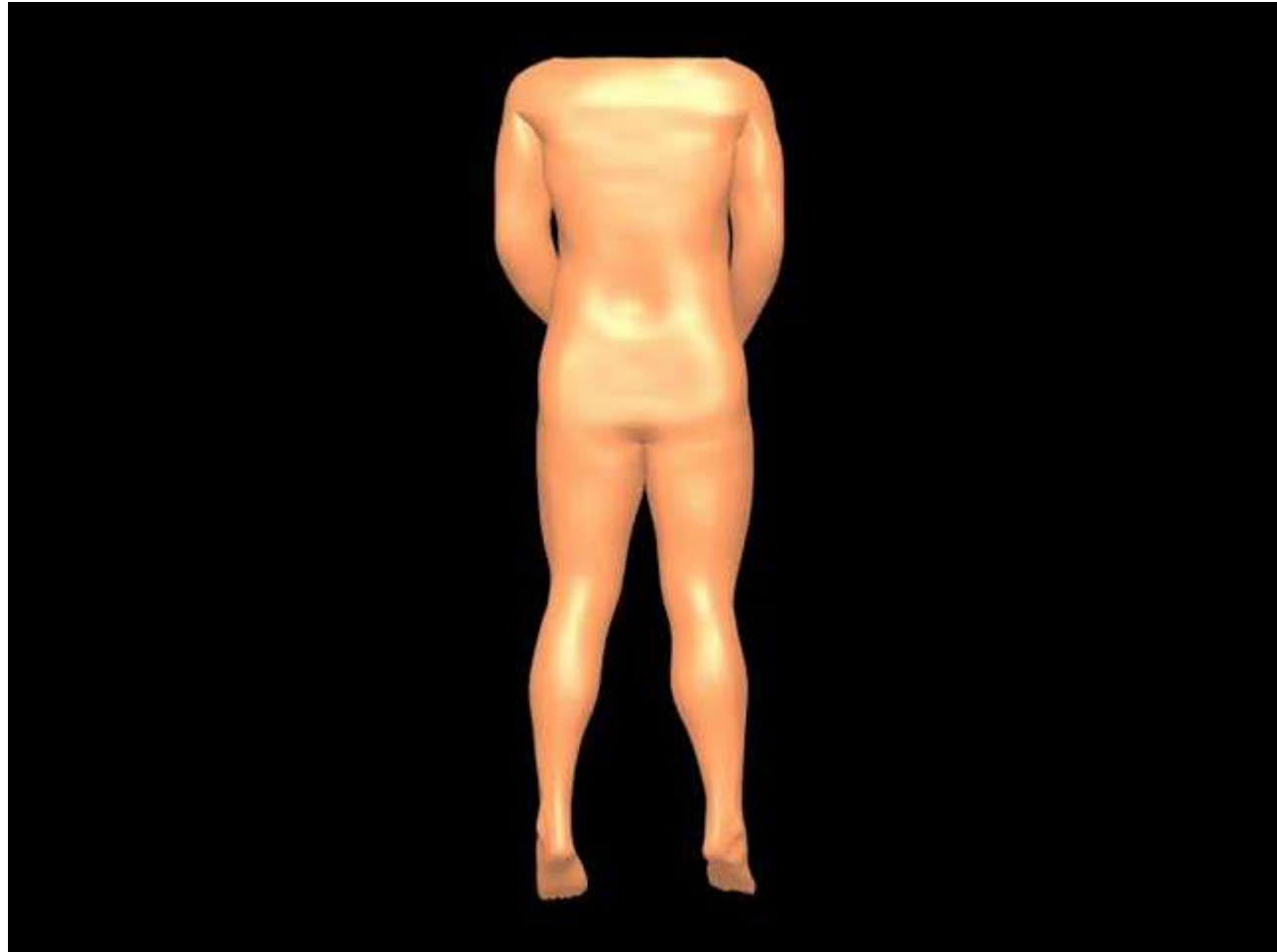

Part I
Multi-Body Model

Part II
Continuum Model

Part III
Coupled Model

Part IV
Future Potential



NUMERICAL EXAMPLE: COMBINED MODEL

- **First approach towards an integrated model** (Farina, Negro)
 - Electrophysiological model of the motoneurons
 - Biophysical model of the half-sarcomere - active stress
- **Mathematical model:** nonlinear ordinary differential equations
- **Stimulation:** noise-superimposed constant excitation

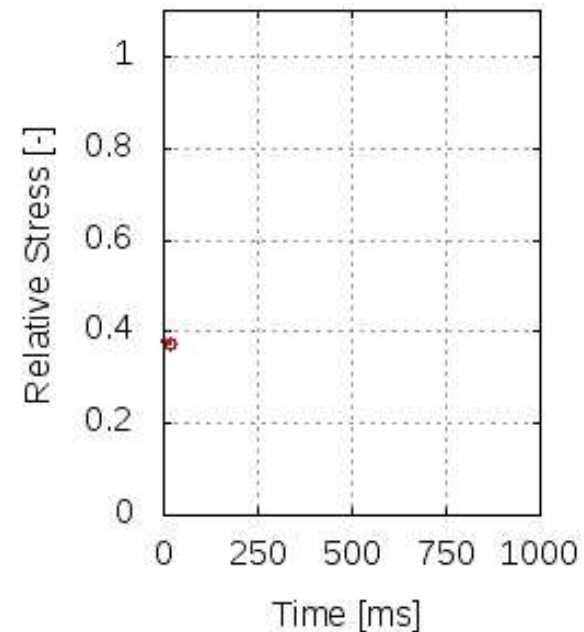
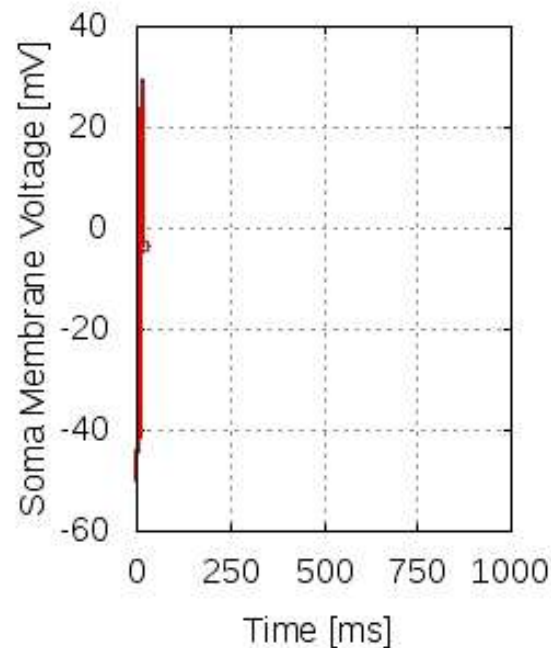

Part I
Multi-Body Model

Part II
Continuum Model

Part III
Coupled Model

Part IV
Future Potential



UPSCALING / HOMOGENISATION

Cellular variables at the Gauss points are computed by averaging the cellular variables of the closest grid points

- Part I
Multi-Body Model
- Part II
Continuum Model
- Part III
Coupled Model
- Part IV
Future Potential

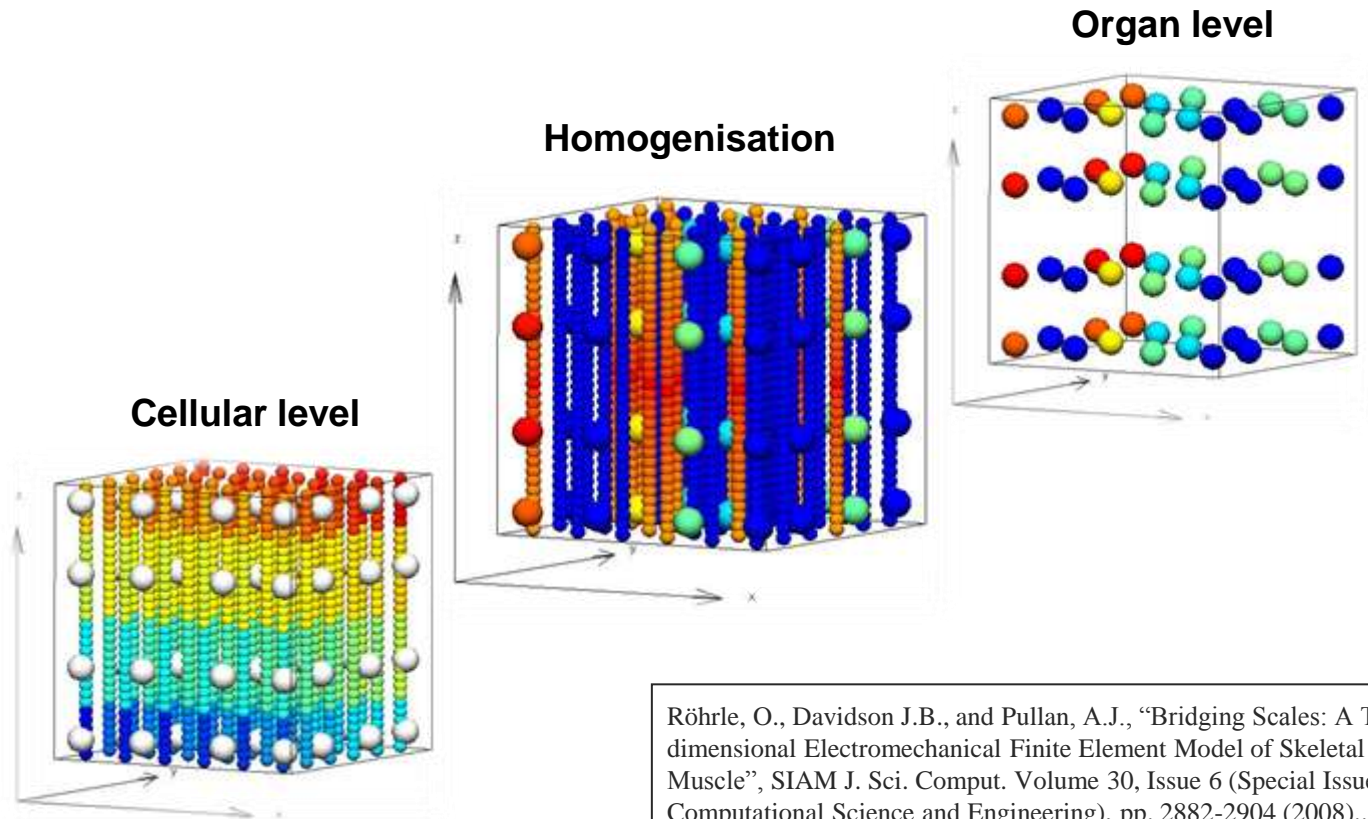

Röhrle, O., Davidson J.B., and Pullan, A.J., "Bridging Scales: A Three-dimensional Electromechanical Finite Element Model of Skeletal Muscle", SIAM J. Sci. Comput. Volume 30, Issue 6 (Special Issue: Computational Science and Engineering), pp. 2882-2904 (2008)..



STIMULATION OF TIBIALIS ANTERIOR

- **The mechanical finite element mesh consists of 16 quadratic Lagrange elements.**
- **A single muscle fibre is made up of 90 grid points.**
- **A total of 1024 “fibres” are embedded within the tibialis muscle.**
- **70/30 distribution of muscle fibre Type I/II (slow/fast).**
- **The simulation captures 275ms. The cellular variables and the resulting deformations are calculated in 1ms increments.**



Figure: Superficial (red), deep (gold) tibialis anterior and skin and fat (grey)

Part I
Multi-Body Model

Part II
Continuum Model

Part III
Coupled Model

Part IV
Future Potential



"EXTERNAL" STIMULATION

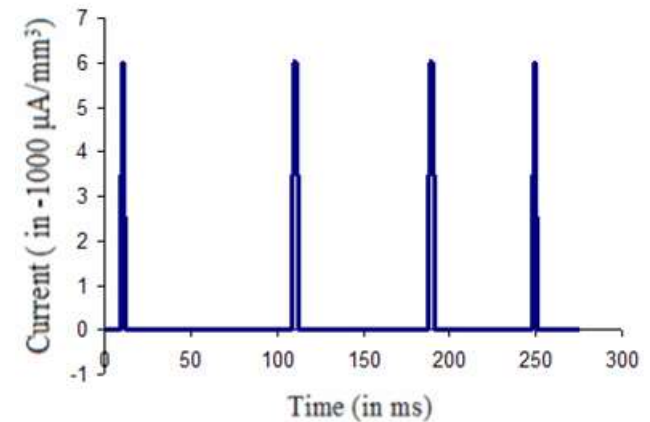
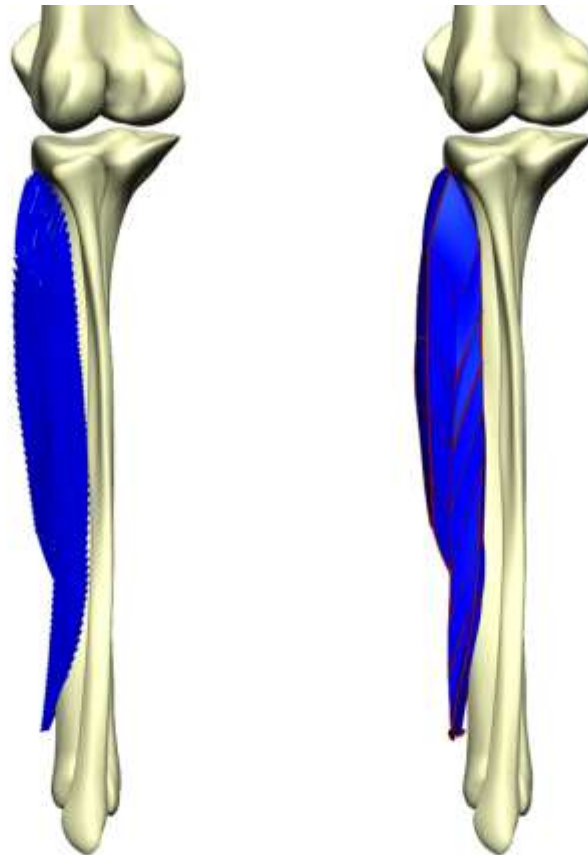

Stimulation protocol defining $I_{\text{stim}}(t)$ at the nodal locations of the neuromuscular junctions.

O. Röhrle, "Simulating the Electro-Mechanical Behavior of Skeletal Muscles", IEEE Computing in Science and Engineering, DOI 10.1109/MCSE.2010.30

Part I
Multi-Body Model

Part II
Continuum Model

Part III
Coupled Model

Part IV
Future Potential



WORK IN PROGRESS

- **Compute virtual EMG signals (for validation and testing).**
- **Include a mechanical-based spindle model within the electro-mechanical framework.**
- **Include a biophysical motoneuron model including the feedback from the spindle model.**
- **DT-MRI for complex muscle fibre distributions.**
- **Extend framework to simulate the dynamics of a multi-muscle systems during gait (-> residual limb as FP7 ERC Starting Grant).**



Part I
Multi-Body Model

Part II
Continuum Model

Part III
Coupled Model

Part IV
Future Potential



PART III

COUPLING MULTI-BODY SIMULATIONS WITH CONTINUUM MECHANICAL MODELS



FORWARD DYNAMICS FE MODELLING

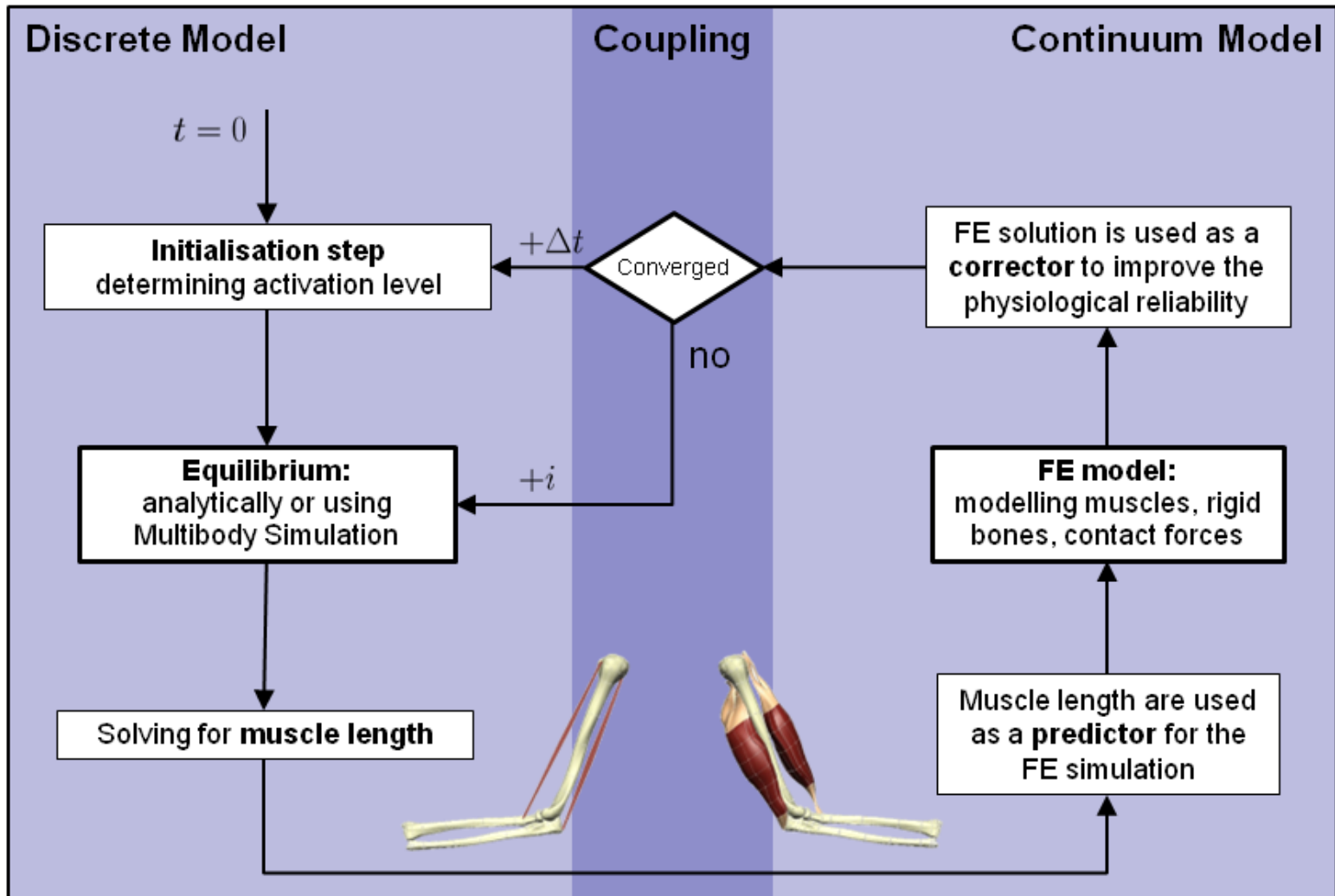

- Part I
Multi-Body Model
- Part II
Continuum Model
- Part III
Coupled Model**
- Part IV
Future Potential



ACTIVATION DRIVEN MOVEMENT

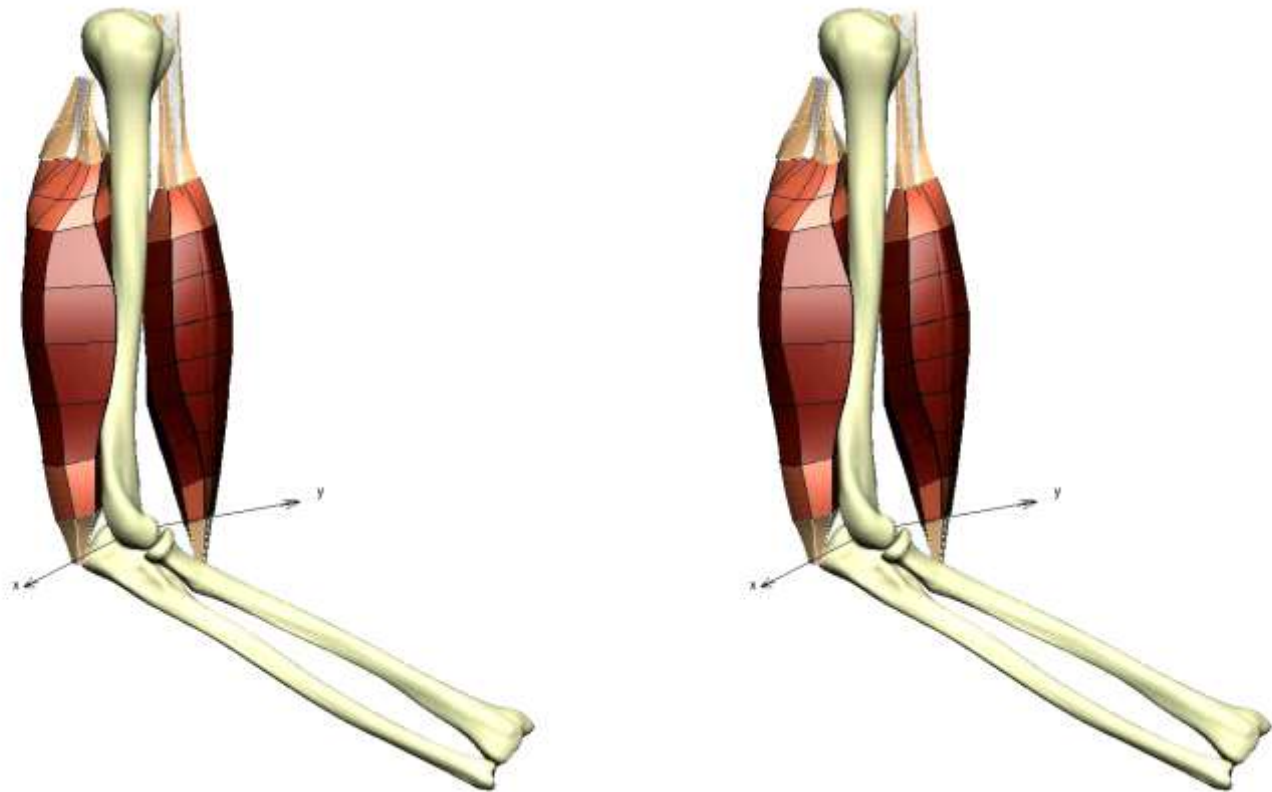

- Part I
Multi-Body Model
- Part II
Continuum Model
- Part III
Coupled Model**
- Part IV
Future Potential

In both cases, the activation of the biceps and triceps are simultaneously and linearly increased from 0..1. Left without contact, right with bone-muscle contact.



COUPLING DIFFERENT FRAMEWORKS

- Part I
Multi-Body Model
- Part II
Continuum Model
- Part III
Coupled Model
- Part IV
Future Potential

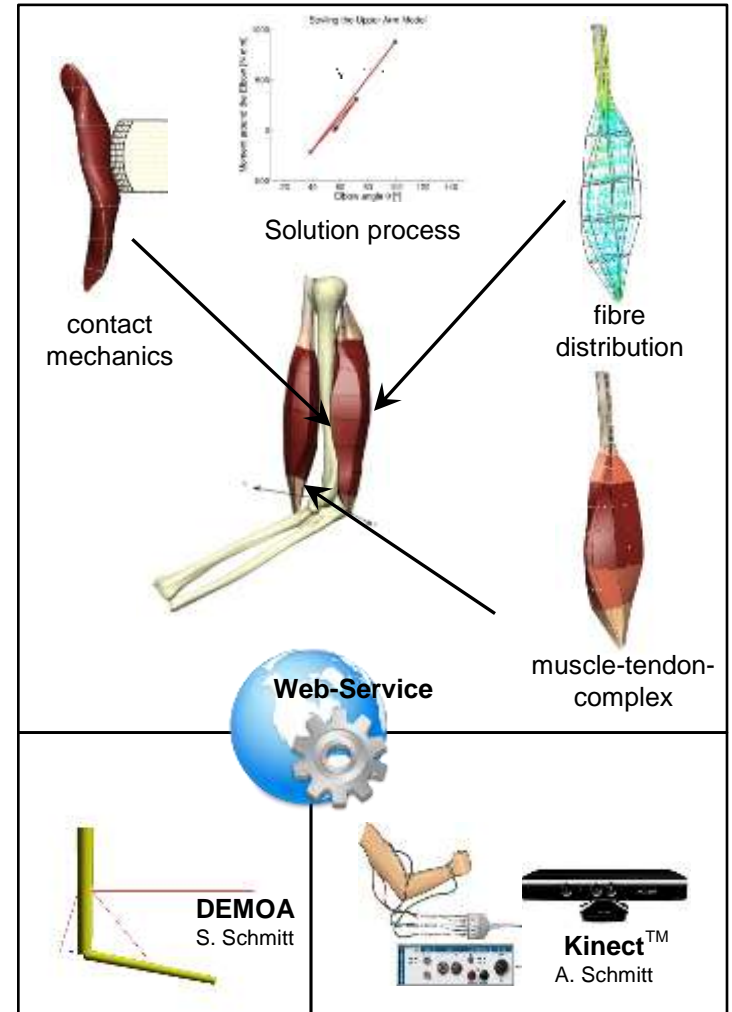



FIRST RESULTS

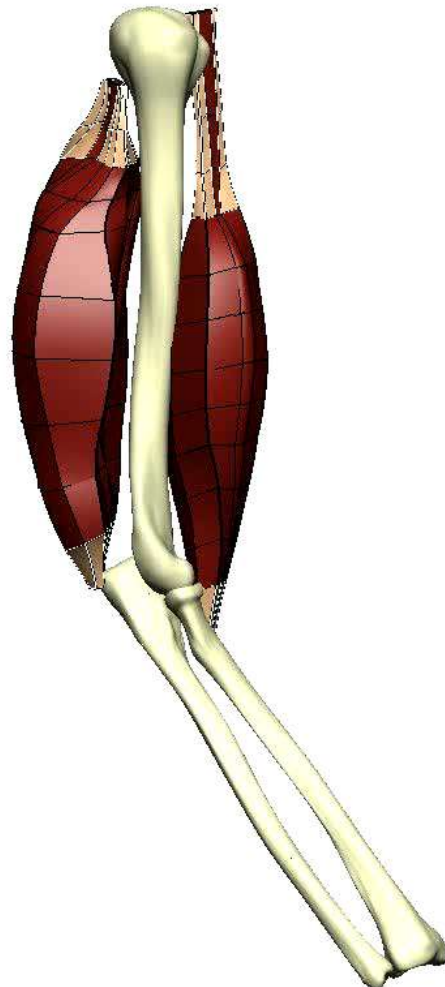

- **Activation-driven musculo-skeletal movement**
- **Activation of the triceps is maintained, while the activation for the biceps is linearly increased.**
- **Multi-body pre-calculation and corrections from a continuum-mechanical problem that accounts for complex structural arrangements, e.g. fibre distribution, muscle-bone contact.**

Part I
Multi-Body Model

Part II
Continuum Model

Part III
Coupled Model

Part IV
Future Potential



PART IV

POTENTIALS FOR ADVANCED MUSCULOSKELETAL MODELS



FUTURE POTENTIALS

- **More realistic (crash) simulations due to activation driven musculoskeletal models:**
 - **Mechanical properties of joints**
 - **Force/Stress distribution due to full contact**



Human factor in pedestrian-car safety
Human factor in passenger safety
Human factor in comfort/car ergonomics

- **Ultimate goal: A realistic biomechanical-based avatar**

Part I
Multi-Body Model

Part II
Continuum Model

Part III
Coupled Model

Part IV
Future Potential

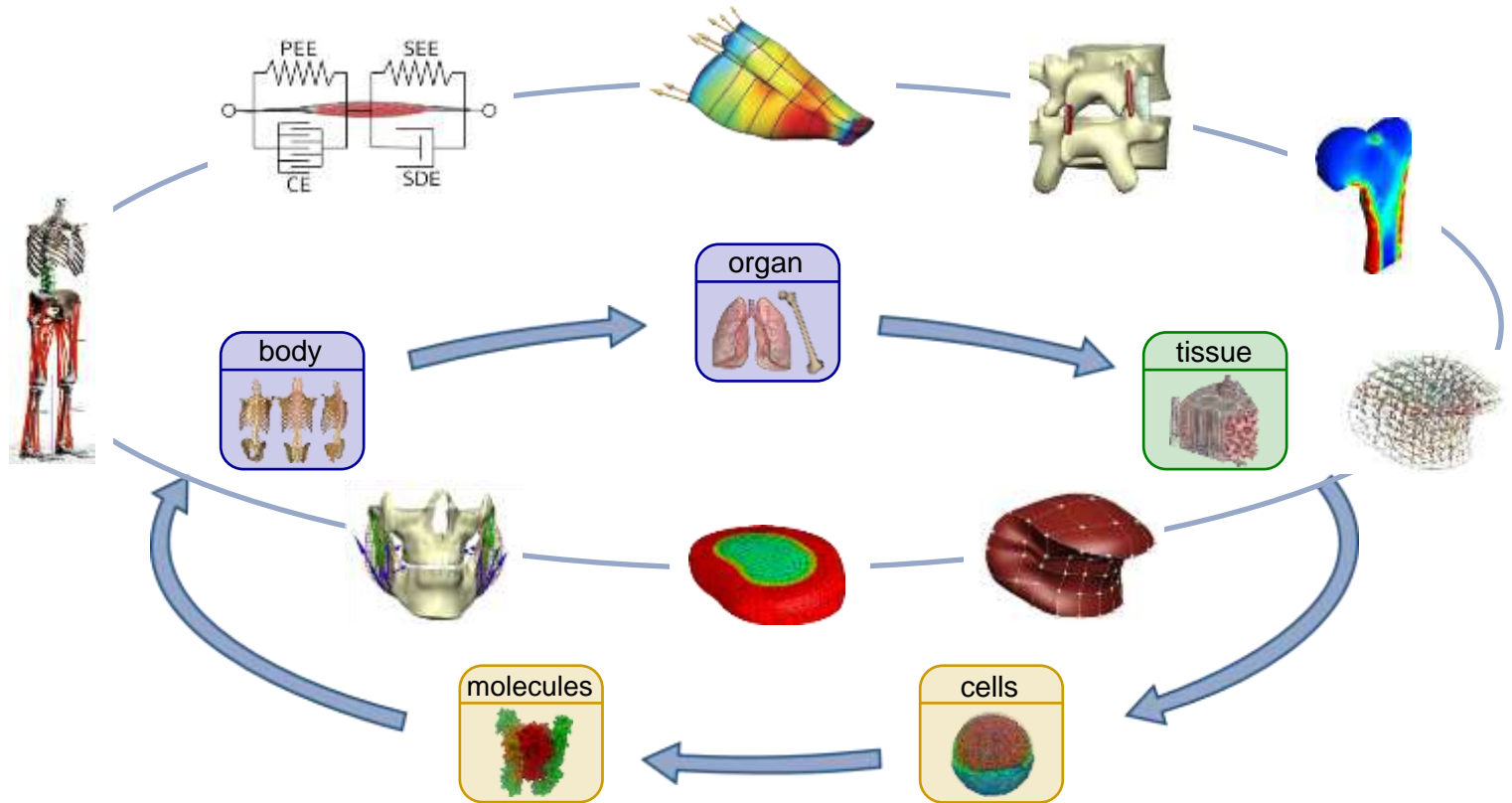

THANK YOU!