

LS-DYNA[®]
KEYWORD USER'S MANUAL

VOLUME II
Material Models

LS-DYNA R7.1

May 19, 2014 (revision: 5442)

LIVERMORE SOFTWARE TECHNOLOGY CORPORATION (LSTC)

Corporate Address

Livermore Software Technology Corporation
P. O. Box 712
Livermore, California 94551-0712

Support Addresses

LSTC
7374 Las Positas Road
Livermore, California 94551
Tel: 925-449-2500 ♦ Fax: 925-449-2507
Email: sales@lstc.com
Website: www.lstc.com

LSTC
1740 West Big Beaver Road
Suite 100
Troy, Michigan 48084
Tel: 248-649-4728 ♦ Fax: 248-649-6328

Disclaimer

Copyright © 1992-2014 Livermore Software Technology Corporation. All Rights Reserved.

LS-DYNA®, LS-OPT® and LS-PrePost® are registered trademarks of Livermore Software Technology Corporation in the United States. All other trademarks, product names and brand names belong to their respective owners.

LSTC reserves the right to modify the material contained within this manual without prior notice.

The information and examples included herein are for illustrative purposes only and are not intended to be exhaustive or all-inclusive. LSTC assumes no liability or responsibility whatsoever for any direct or indirect damages or inaccuracies of any type or nature that could be deemed to have resulted from the use of this manual.

Any reproduction, in whole or in part, of this manual is prohibited without the prior written approval of LSTC. All requests to reproduce the contents hereof should be sent to sales@lstc.com.

AES

Copyright © 2001, Dr Brian Gladman <brg@gladman.uk.net>, Worcester, UK. All rights reserved.

LICENSE TERMS

The free distribution and use of this software in both source and binary form is allowed (with or without changes) provided that:

1. distributions of this source code include the above copyright notice, this list of conditions and the following disclaimer;
2. distributions in binary form include the above copyright notice, this list of conditions and the following disclaimer in the documentation and/or other associated materials;
3. the copyright holder's name is not used to endorse products built using this software without specific written permission.

DISCLAIMER

This software is provided 'as is' with no explicit or implied warranties in respect of any properties, including, but not limited to, correctness and fitness for purpose.

Issue Date: 21/01/2002

This file contains the code for implementing the key schedule for AES (Rijndael) for block and key sizes of 16, 24, and 32 bytes.

TABLE OF CONTENTS

TABLE OF CONTENTS	0-1
*EOS.....	1-1
*EOS_LINEAR_POLYNOMIAL	1-7
*EOS_JWL.....	1-9
*EOS_SACK_TUESDAY	1-10
*EOS_GRUNEISEN	1-11
*EOS_RATIO_OF_POLYNOMIALS	1-13
*EOS_LINEAR_POLYNOMIAL_WITH_ENERGY_LEAK	1-17
*EOS_IGNITION_AND_GROWTH_OF_REACTION_IN_HE.....	1-19
*EOS_TABULATED_COMPACTION	1-23
*EOS_TABULATED	1-25
*EOS_PROPELLANT_DEFLAGRATION.....	1-27
*EOS_TENSOR_PORE_COLLAPSE	1-32
*EOS_IDEAL_GAS.....	1-35
*EOS_JWLB	1-37
*EOS_GASKET	1-41
*EOS_MIE_GRUNEISEN	1-44
*EOS_USER_DEFINED	1-46
*MAT.....	2-1
MATERIAL MODEL REFERENCE TABLES	2-8
ALPHABETIZED MATERIALS LIST.....	2-18
*MAT_ADD_AIRBAG_POROSITY_LEAKAGE.....	2-28
*MAT_ADD_COHESIVE.....	2-31
*MAT_ADD_EROSION	2-34
*MAT_ADD_PERMEABILITY.....	2-52
*MAT_ADD_PORE_AIR	2-53
*MAT_ADD_THERMAL_EXPANSION	2-55
*MAT_NONLOCAL.....	2-57
*MAT_ELASTIC	2-61
*MAT_{OPTION}TROPIC_ELASTIC	2-64
*MAT_PLASTIC_KINEMATIC.....	2-74
*MAT_ELASTIC_PLASTIC_THERMAL.....	2-77
*MAT_SOIL_AND_FOAM	2-80

*TABLE OF CONTENTS

*MAT_VISCOELASTIC	2-84
*MAT_BLATZKO_RUBBER.....	2-86
*MAT_HIGH_EXPLOSIVE_BURN.....	2-87
*MAT_NULL	2-90
*MAT_ELASTIC_PLASTIC_HYDRO	2-92
*MAT_STEINBERG.....	2-97
*MAT_STEINBERG_LUND	2-101
*MAT_ISOTROPIC_ELASTIC_PLASTIC.....	2-105
*MAT_ISOTROPIC_ELASTIC_FAILURE.....	2-106
*MAT_SOIL_AND_FOAM_FAILURE.....	2-108
*MAT_JOHNSON_COOK.....	2-109
*MAT_PSEUDO_TENSOR.....	2-116
*MAT_ORIENTED_CRACK.....	2-124
*MAT_POWER_LAW_PLASTICITY	2-127
*MAT_STRAIN_RATE_DEPENDENT_PLASTICITY.....	2-129
*MAT_RIGID	2-132
*MAT_ORTHOTROPIC_THERMAL	2-138
*MAT_COMPOSITE_DAMAGE	2-144
*MAT_TEMPERATURE_DEPENDENT_ORTHOTROPIC.....	2-149
*MAT_PIECEWISE_LINEAR_PLASTICITY	2-154
*MAT_GEOLOGIC_CAP_MODEL	2-161
*MAT_HONEYCOMB	2-167
*MAT_MOONEYRIVLIN_RUBBER	2-175
*MAT_RESULTANT_PLASTICITY	2-178
*MAT_FORCE_LIMITED.....	2-179
*MAT_SHAPE_MEMORY	2-186
*MAT_FRAZER_NASH_RUBBER_MODEL.....	2-191
*MAT_LAMINATED_GLASS.....	2-194
*MAT_BARLAT_ANISOTROPIC_PLASTICITY	2-196
*MAT_BARLAT_YLD96	2-200
*MAT_FABRIC.....	2-204
*MAT_PLASTIC_GREEN-NAGHDI_RATE.....	2-216
*MAT_3-PARAMETER_BARLAT	2-217
*MAT_TRANSVERSELY_ANISOTROPIC_ELASTIC_PLASTIC.....	2-232
*MAT_BLATZ-KO_FOAM.....	2-241
*MAT_FLD_TRANSVERSELY_ANISOTROPIC.....	2-243
*MAT_NONLINEAR_ORTHOTROPIC	2-245

*TABLE OF CONTENTS

*MAT_USER_DEFINED_MATERIAL_MODELS.....	2-250
*MAT_BAMMAN.....	2-255
*MAT_BAMMAN_DAMAGE	2-260
*MAT_CLOSED_CELL_FOAM	2-263
*MAT_ENHANCED_COMPOSITE_DAMAGE.....	2-266
*MAT_LOW_DENSITY_FOAM.....	2-276
*MAT_LAMINATED_COMPOSITE_FABRIC.....	2-281
*MAT_COMPOSITE_FAILURE	2-290
*MAT_ELASTIC_WITH_VISCOSITY	2-295
*MAT_ELASTIC_WITH_VISCOSITY_CURVE	2-298
*MAT_KELVIN-MAXWELL_VISCOELASTIC	2-301
*MAT_VISCOUS_FOAM.....	2-303
*MAT_CRUSHABLE_FOAM.....	2-305
*MAT_RATE_SENSITIVE_POWERLAW_PLASTICITY	2-307
*MAT_MODIFIED_ZERILLI_ARMSTRONG	2-309
*MAT_LINEAR_ELASTIC_DISCRETE_BEAM	2-312
*MAT_NONLINEAR_ELASTIC_DISCRETE_BEAM	2-315
*MAT_NONLINEAR_PLASTIC_DISCRETE_BEAM	2-320
*MAT_SID_DAMPER_DISCRETE_BEAM.....	2-326
*MAT_HYDRAULIC_GAS_DAMPER_DISCRETE_BEAM.....	2-330
*MAT_CABLE_DISCRETE_BEAM.....	2-332
*MAT_CONCRETE_DAMAGE	2-335
*MAT_CONCRETE_DAMAGE_REL3	2-339
*MAT_LOW_DENSITY_VISCOUS_FOAM	2-348
*MAT_ELASTIC_SPRING_DISCRETE_BEAM.....	2-353
*MAT_BILKHU/DUBOIS_FOAM.....	2-355
*MAT_GENERAL_VISCOELASTIC.....	2-358
*MAT_HYPERELASTIC_RUBBER.....	2-363
*MAT_OGDEN_RUBBER	2-369
*MAT_SOIL_CONCRETE	2-374
*MAT_HYSTERETIC_SOIL	2-378
*MAT_RAMBERG-OSGOOD	2-385
*MAT_PLASTICITY_WITH_DAMAGE.....	2-387
*MAT_FU_CHANG_FOAM_{OPTION}	2-396
*MAT_WINFRITH_CONCRETE	2-406
*MAT_WINFRITH_CONCRETE_REINFORCEMENT	2-410
*MAT_ORTHOTROPIC_VISCOELASTIC.....	2-412

*TABLE OF CONTENTS

*MAT_CELLULAR_RUBBER.....	2-415
*MAT_MTS	2-419
*MAT_PLASTICITY_POLYMER.....	2-423
*MAT_ACOUSTIC	2-426
*MAT_SOFT_TISSUE	2-428
*MAT_ELASTIC_6DOF_SPRING_DISCRETE_BEAM	2-433
*MAT_INELASTIC_SPRING_DISCRETE_BEAM	2-435
*MAT_INELASTIC_6DOF_SPRING_DISCRETE_BEAM.....	2-438
*MAT_BRITTLE_DAMAGE	2-440
*MAT_GENERAL_JOINT_DISCRETE_BEAM.....	2-443
*MAT_SIMPLIFIED_JOHNSON_COOK	2-445
*MAT_SIMPLIFIED_JOHNSON_COOK_ORTHOTROPIC_DAMAGE.....	2-448
*MAT_SPOTWELD	2-450
*MAT_SPOTWELD_DAIMLERCHRYSLER	2-466
*MAT_GEPLASTIC_SRATE_2000A.....	2-469
*MAT_INV_HYPERBOLIC_SIN.....	2-471
*MAT_ANISOTROPIC_VISCOPLASTIC	2-473
*MAT_ANISOTROPIC_PLASTIC	2-479
*MAT_DAMAGE_1.....	2-483
*MAT_DAMAGE_2.....	2-489
*MAT_ELASTIC_VISCOPLASTIC_THERMAL	2-493
*MAT_MODIFIED_JOHNSON_COOK.....	2-496
*MAT_ORTHO_ELASTIC_PLASTIC	2-504
*MAT_JOHNSON_HOLMQUIST_CERAMICS.....	2-509
*MAT_JOHNSON_HOLMQUIST_CONCRETE.....	2-512
*MAT_FINITE_ELASTIC_STRAIN_PLASTICITY	2-515
*MAT_TRIP	2-518
*MAT_LAYERED_LINEAR_PLASTICITY	2-522
*MAT_UNIFIED_CREEP	2-526
*MAT_COMPOSITE_LAYUP	2-528
*MAT_COMPOSITE_MATRIX	2-531
*MAT_COMPOSITE_DIRECT	2-534
*MAT_GENERAL_NONLINEAR_6DOF_DISCRETE_BEAM	2-536
*MAT_GURSON	2-544
*MAT_GURSON_JC.....	2-550
*MAT_GURSON_RCDC	2-557
*MAT_GENERAL_NONLINEAR_1DOF_DISCRETE_BEAM	2-563

*TABLE OF CONTENTS

*MAT_HILL_3R.....	2-566
*MAT_MODIFIED_PIECEWISE_LINEAR_PLASTICITY	2-569
*MAT_PLASTICITY_COMPRESSION_TENSION	2-574
*MAT_KINEMATIC_HARDENING_TRANSVERSELY_ANISOTROPIC.....	2-578
*MAT_MODIFIED_HONEYCOMB	2-588
*MAT_ARRUDA_BOYCE_RUBBER	2-600
*MAT_HEART_TISSUE.....	2-603
*MAT_LUNG_TISSUE	2-608
*MAT_SPECIAL_ORTHOTROPIC	2-611
*MAT_ISOTROPIC_SMEARED_CRACK	2-615
*MAT_ORTHOTROPIC_SMEARED_CRACK	2-618
*MAT_BARLAT_YLD2000	2-623
*MAT_VISCOELASTIC_FABRIC.....	2-636
*MAT_WTM_STM.....	2-639
*MAT_WTM_STM_PLC	2-649
*MAT_CORUS_VEGTER	2-654
*MAT_COHESIVE_MIXED_MODE	2-660
*MAT_MODIFIED_FORCE_LIMITED	2-665
*MAT_VACUUM	2-676
*MAT_RATE_SENSITIVE_POLYMER.....	2-677
*MAT_TRANSVERSELY_ISOTROPIC_CRUSHABLE_FOAM	2-679
*MAT_WOOD	2-683
*MAT_PITZER_CRUSHABLE_FOAM.....	2-690
*MAT_SCHWER_MURRAY_CAP_MODEL	2-692
*MAT_1DOF_GENERALIZED_SPRING.....	2-700
*MAT_FHWA_SOIL	2-702
*MAT_FHWA_SOIL_NEBRASKA	2-705
*MAT_GAS_MIXTURE.....	2-706
*MAT_EMMI	2-713
*MAT_DAMAGE_3.....	2-720
*MAT_DESHPANDE_FLECK_FOAM.....	2-725
*MAT_PLASTICITY_COMPRESSION_TENSION_EOS.....	2-728
*MAT_MUSCLE.....	2-733
*MAT_ANISOTROPIC_ELASTIC_PLASTIC.....	2-737
*MAT_RATE_SENSITIVE_COMPOSITE_FABRIC	2-741
*MAT_CSCM.....	2-747
*MAT_ALE_INCOMPRESSIBLE.....	2-758

*TABLE OF CONTENTS

*MAT_COMPOSITE_MSC.....	2-760
*MAT_MODIFIED_CRUSHABLE_FOAM.....	2-771
*MAT_BRAIN_LINEAR_VISCOELASTIC.....	2-774
*MAT_PLASTIC_NONLINEAR_KINEMATIC.....	2-776
*MAT_MOMENT_CURVATURE_BEAM.....	2-778
*MAT_MCCORMICK.....	2-782
*MAT_POLYMER.....	2-785
*MAT_ARUP_ADHESIVE.....	2-790
*MAT_RESULTANT_ANISOTROPIC.....	2-797
*MAT_STEEL_CONCENTRIC_BRACE.....	2-801
*MAT_CONCRETE_EC2.....	2-806
*MAT_MOHR_COULOMB.....	2-821
*MAT_RC_BEAM.....	2-826
*MAT_VISCOELASTIC_THERMAL.....	2-832
*MAT_QUASILINEAR_VISCOELASTIC.....	2-836
*MAT_HILL_FOAM.....	2-841
*MAT_VISCOELASTIC_HILL_FOAM.....	2-844
*MAT_LOW_DENSITY_SYNTHETIC_FOAM.....	2-848
*MAT_SIMPLIFIED_RUBBER/FOAM.....	2-853
*MAT_SIMPLIFIED_RUBBER_WITH_DAMAGE.....	2-860
*MAT_COHESIVE_ELASTIC.....	2-863
*MAT_COHESIVE_TH.....	2-864
*MAT_COHESIVE_GENERAL.....	2-867
*MAT_SAMP-1.....	2-871
*MAT_THERMO_ELASTO_VISCOPLASTIC_CREEP.....	2-878
*MAT_ANISOTROPIC_THERMOELASTIC.....	2-883
*MAT_FLD_3-PARAMETER_BARLAT.....	2-886
*MAT_SEISMIC_BEAM.....	2-892
*MAT_SOIL_BRICK.....	2-901
*MAT_DRUCKER_PRAGER.....	2-904
*MAT_RC_SHEAR_WALL.....	2-906
*MAT_CONCRETE_BEAM.....	2-913
*MAT_GENERAL_SPRING_DISCRETE_BEAM.....	2-916
*MAT_SEISMIC_ISOLATOR.....	2-920
*MAT_JOINTED_ROCK.....	2-926
*MAT_STEEL_EC3.....	2-931
*MAT_BOLT_BEAM.....	2-934

*TABLE OF CONTENTS

*MAT_CODAM2	2-937
*MAT_DRY_FABRIC.....	2-948
*MAT_RIGID_DISCRETE.....	2-955
*MAT_ORTHOTROPIC_SIMPLIFIED_DAMAGE	2-956
*MAT_TABULATED_JOHNSON_COOK	2-964
*MAT_VISCOPLASTIC_MIXED_HARDENING	2-970
*MAT_KINEMATIC_HARDENING_BARLAT89.....	2-972
*MAT_PML_ELASTIC.....	2-979
*MAT_PML_ELASTIC_FLUID.....	2-981
*MAT_PML_ACOUSTIC	2-982
*MAT_BIOT_HYSTERETIC.....	2-984
*MAT_CAZACU_BARLAT	2-986
*MAT_VISCOELASTIC_LOOSE_FABRIC.....	2-998
*MAT_MICROMECHANICS_DRY_FABRIC	2-1004
*MAT_SCC_ON_RCC	2-1010
*MAT_PML_HYSTERETIC	2-1014
*MAT_PERT_PIECEWISE_LINEAR_PLASTICITY	2-1015
*MAT_COHESIVE_MIXED_MODE_ELASTOPLASTIC_RATE	2-1016
*MAT_JOHNSON_HOLMQUIST_JH1.....	2-1024
*MAT_KINEMATIC_HARDENING_BARLAT2000.....	2-1028
*MAT_HILL_90	2-1033
*MAT_UHS_STEEL	2-1042
*MAT_PML_{OPTION}TROPIC_ELASTIC	2-1060
*MAT_PML_NULL	2-1063
*MAT_TAILORED_PROPERTIES	2-1065
*MAT_TOUGHENED_ADHESIVE_POLYMER.....	2-1068
*MAT_PIECEWISE_LINEAR_PLASTIC_THERMAL.....	2-1075
*MAT_AMORPHOUS_SOLIDS_FINITE_STRAIN	2-1078
*MAT_LAMINATED_FRACTURE_DAIMLER_PINHO	2-1081
*MAT_LAMINATED_FRACTURE_DAIMLER_CAMANHO	2-1090
*MAT_TISSUE_DISPERSED	2-1100
*MAT_EIGHT_CHAIN_RUBBER.....	2-1107
*MAT_BERGSTROM_BOYCE_RUBBER	2-1116
*MAT_CWM.....	2-1119
*MAT_POWDER.....	2-1123
*MAT_RHT.....	2-1130
*MAT_CONCRETE_DAMAGE_PLASTIC_MODEL.....	2-1138

*TABLE OF CONTENTS

*MAT_CHRONOLOGICAL_VISCOELASTIC	2-1144
*MAT_ALE_VACUUM.....	2-1148
*MAT_ALE_GAS_MIXTURE	2-1149
*MAT_ALE_MIXING_LENGTH.....	2-1159
*MAT_ALE_INCOMPRESSIBLE	2-1162
*MAT_ALE_HERSCHEL	2-1163
*MAT_SPRING_ELASTIC	2-1166
*MAT_DAMPER_VISCOUS	2-1167
*MAT_SPRING_ELASTOPLASTIC	2-1168
*MAT_SPRING_NONLINEAR_ELASTIC	2-1169
*MAT_DAMPER_NONLINEAR_VISCOUS.....	2-1170
*MAT_SPRING_GENERAL_NONLINEAR	2-1171
*MAT_SPRING_MAXWELL	2-1173
*MAT_SPRING_INELASTIC	2-1175
*MAT_SPRING_TRILINEAR_DEGRADING	2-1176
*MAT_SPRING_SQUAT_SHEARWALL.....	2-1177
*MAT_SPRING_MUSCLE	2-1178
*MAT_SEATBELT	2-1183
*MAT_THERMAL.....	2-1185
*MAT_THERMAL_ISOTROPIC.....	2-1186
*MAT_THERMAL_ORTHOTROPIC	2-1187
*MAT_THERMAL_ISOTROPIC_TD	2-1189
*MAT_THERMAL_ORTHOTROPIC_TD.....	2-1191
*MAT_THERMAL_DISCRETE_BEAM.....	2-1194
*MAT_THERMAL_CWM.....	2-1195
*MAT_THERMAL_ORTHOTROPIC_TD_LC	2-1198
*MAT_THERMAL_ISOTROPIC_PHASE_CHANGE	2-1201
*MAT_THERMAL_ISOTROPIC_TD_LC.....	2-1204
*MAT_THERMAL_USER_DEFINED	2-1205

*EOS

LS-DYNA has historically referenced equations of state by type identifiers. Below these identifiers are given with the corresponding keyword name in the order that they appear in the manual. The equations of state can be used with a subset of the materials that are available for solid elements. Type 15 is linked to the type 2 thick shell element and can be used to model engine gaskets.

TYPE 1:	*EOS_LINEAR_POLYNOMIAL
TYPE 2:	*EOS_JWL
TYPE 3:	*EOS_SACK_TUESDAY
TYPE 4:	*EOS_GRUNEISEN
TYPE 5:	*EOS_RATIO_OF_POLYNOMIALS
TYPE 6:	*EOS_LINEAR_POLYNOMIAL_WITH_ENERGY_LEAK
TYPE 7:	*EOS_IGNITION_AND_GROWTH_OF_REACTION_IN_HE
TYPE 8:	*EOS_TABULATED_COMPACTION
TYPE 9:	*EOS_TABULATED
TYPE 10:	*EOS_PROPELLANT_DEFLAGRATION
TYPE 11:	*EOS_TENSOR_PORE_COLLAPSE
TYPE 12:	*EOS_IDEAL_GAS
TYPE 14:	*EOS_JWLB
TYPE 15:	*EOS_GASKET
TYPE 16:	*EOS_MIE_GRUNEISEN
TYPE 21-30:	*EOS_USER_DEFINED

An additional option **TITLE** may be appended to all the ***EOS** keywords. If this option is used then an additional line is read for each section in 80a format which can be used to describe the equation of state. At present LS-DYNA does not make use of the title. Inclusion of title simply gives greater clarity to input decks.

*EOS

Definitions and Conventions

In order to prescribe the boundary and/or initial thermodynamic condition, manual computations are often necessary. Conventions or definitions must be established to simplify this process. Some basic variables are defined in the following. Since many of these variables have already been denoted by different symbols, the notations used here are unique in this section only! They are presented to only clarify their usage. A corresponding SI unit set is also presented as an example.

First consider a few volumetric parameters since they are a measure of compression (or expansion).

Volume:

$$V \approx (\text{m}^3)$$

Mass:

$$M \approx (\text{Kg})$$

Current specific volume (per mass):

$$v = \frac{V}{M} = \frac{1}{\rho} \approx \left(\frac{\text{m}^3}{\text{Kg}} \right)$$

Reference specific volume:

$$v_0 = \frac{V_0}{M} = \frac{1}{\rho_0} \approx \left(\frac{\text{m}^3}{\text{Kg}} \right)$$

Relative volume:

$$v_r = \frac{V}{V_0} = \frac{(V/M)}{(V_0/M)} = \frac{v}{v_0} = \frac{\rho_0}{\rho}$$

Current normalized volume increment:

$$\frac{dv}{v} = \frac{v - v_0}{v} = 1 - \frac{1}{v_r} = 1 - \frac{\rho}{\rho_0}$$

A frequently used volumetric parameter is:

$$\mu = \frac{1}{v_r} - 1 = \frac{v_0 - v}{v} = -\frac{dv}{v} = \frac{\rho}{\rho_0} - 1$$

Sometimes another volumetric parameter is used:

$$\eta = \frac{v_0}{v} = \frac{\rho}{\rho_0}$$

Thus, the relation between μ and η is,

$$\mu = \frac{v_0 - v}{v} = \eta - 1$$

The following table summarizes these volumetric parameters.

VARIABLES	COMPRESSION	NO LOAD	EXPANSION
$v_r = \frac{v}{v_0} = \frac{\rho_0}{\rho}$	< 1	1	> 1
$\eta = \frac{1}{v_r} = \frac{v_0}{v} = \frac{\rho}{\rho_0}$	> 1	1	< 1
$\mu = \frac{1}{v_r} - 1 = \eta - 1$	> 0	0	< 0

V0 – Initial Relative Volume

There are 3 definitions of density that must be distinguished from each other:

$$\rho_0 = \rho_{\text{ref}}$$

= Density at nominal/reference state, usually non-stress or non-deformed state.

$$\rho|_{t=0} = \text{Density at time 0}$$

$$\rho = \text{Current density}$$

Recalling the current relative volume

$$v_r = \frac{\rho_0}{\rho} = \frac{v}{v_0},$$

at time = 0 the relative volume is

$$v_{r0} = v_r|_{t=0} = \frac{\rho_0}{\rho|_{t=0}} = \frac{v|_{t=0}}{v_0}.$$

Generally, the V0 input parameter in an *EOS card refers to this v_{r0} . ρ_0 is generally the density defined in the *MAT card. Hence, if a material is mechanically compressed at $t = 0$, V0, or v_{r0} , the initial relative volume, may be computed and input accordingly ($v_0 \neq V0$).

The “reference” state is a unique state with respect to which the material stress tensor is computed. Therefore v_0 is very critical in computing the pressure level in a material. Incorrect choice of v_0 would lead to incorrect pressure computed. In general, v_0 is chosen

*EOS

such that at zero compression or expansion, the material should be in equilibrium with its ambient surrounding. In many of the equations shown in the EOS section, μ is frequently used as a measure of compression (or expansion). However, the users must clearly distinguish between μ and v_{r0} .

E0 – Internal Energy

Internal energy represents the thermal energy state (temperature dependent component) of a system. One definition for internal energy is

$$E = MC_vT \approx (\text{Joule})$$

Note that the capital “E” here is the absolute internal energy. It is not the same as that used in the subsequent *EOS keyword input, or some equations shown for each *EOS_card. This internal energy is often defined with respect to a mass or volume unit.

Internal energy per unit mass (also called specific internal energy):

$$e = \frac{E}{M} = C_vT \approx \left(\frac{\text{Joule}}{\text{Kg}} \right)$$

Internal energy per unit current volume:

$$e_V = \frac{M}{V} C_vT = \rho C_vT = \frac{C_vT}{v} \approx \left(\frac{\text{Joule}}{\text{m}^3} = \frac{\text{N}}{\text{m}^2} \right)$$

Internal energy per unit reference volume:

$$e_{V0} = \frac{M}{V_0} C_vT = \rho_0 C_vT = \frac{C_vT}{v_0} \approx \left(\frac{\text{Joule}}{\text{m}^3} = \frac{\text{N}}{\text{m}^2} \right)$$

e_{V0} typically refers to the capital “E” shown in some equations under this “EOS” section. Hence the initial “*internal energy per unit reference volume*”, E0, a keyword input parameter in the *EOS section can be computed from

$$e_{V0}|_{t=0} = \rho_0 C_vT|_{t=0}$$

To convert from e_{V0} to e_V , simply divide e_{V0} by v_r

$$e_V = \rho C_vT = [\rho_0 C_vT] \frac{\rho}{\rho_0} = \frac{e_{V0}}{v_r}$$

Equations of States (EOS)

A thermodynamic state of a homogeneous material, not undergoing any chemical reactions or phase changes, may be defined by two state variables. This relation is generally called an equation of state. For example, a few possible forms relating pressure to two other state variables are

$$P = P(\rho, T) = P(v, e) = P(v_r, e_V) = P(\mu, e_{V0})$$

The last equation form is frequently used to compute pressure. The EOS for solid phase materials is sometimes partitioned into 2 terms, a cold pressure and a thermal pressure

$$P = P_c(\mu) + P_T(\mu, e_{V0})$$

$P_c(\mu)$ is the cold pressure hypothetically evaluated along a 0-degree-Kelvin isotherm. This is sometimes called a 0-K pressure-volume relation or cold compression curve. $P_T(\mu, e_{V0})$ is the thermal pressure component that depends on both volumetric compression and thermal state of the material.

Different forms of the EOS describe different types of materials and how their volumetric compression (or expansion) behaviors. The coefficients for each EOS model come from data-fitting, phenomenological descriptions, or derivations based on classical thermodynamics, etc.

Linear Compression

In low pressure processes, pressure is not significantly affected by temperature. When volumetric compression is within an elastic linear deformation range, a linear bulk modulus may be used to relate volume changes to pressure changes. Recalling the definition of an isotropic bulk modulus is [Fung 1965] $\frac{\Delta v}{v} = -\frac{P}{K}$. This may be rewritten as $P = K[-\frac{\Delta v}{v}] = K\mu$. The bulk modulus, K , thus is equivalent to C_1 in *EOS_LINEAR_POLYNOMIAL when all other coefficients are zero. This is a simplest form of an EOS. To initialize a pressure for such a material, only v_{r0} must be defined.

Initial Conditions

In general, a thermodynamic state must be defined by two state variables. The need to specify v_{r0} and/or $e_{V0}|_{t=0}$ depends on the form of the EOS chosen. The user should review the equation term-by-term to establish what parameters to be initialized.

For many of the EOS available, pressure is specified (given), and the user must make an assumption on either $e_{V0}|_{t=0}$ or v_{r0} . Consider two possibilities (a) $T|_{t=0}$ is defined or assumed from which $e_{V0}|_{t=0}$ may be computed, or (2) $\rho|_{t=0}$ is defined or assumed from which v_{r0} may be obtained.

When to Use EOS

For small strains considerations, a total stress tensor may be partitioned into a deviatoric stress component and a mechanical pressure.

$$\sigma_{ij} = \sigma'_{ij} + \frac{\sigma_{kk}}{3} \delta_{ij} = \sigma'_{ij} - P \delta_{ij}$$

$$P = -\frac{\sigma_{kk}}{3} \Leftrightarrow \frac{\sigma_{kk}}{3} = -P$$

*EOS

The pressure component may be written from the diagonal stress components.

Note that $\frac{\sigma_{kk}}{3} = \frac{[\sigma_{11} + \sigma_{22} + \sigma_{33}]}{3}$ is positive in tension while P is positive in compression.

Similarly, the total strain tensor may be partitioned into a deviatoric strain component (volume-preserving deformation) and a volumetric deformation.

$$\varepsilon_{ij} = \varepsilon'_{ij} + \frac{\varepsilon_{kk}}{3} \delta_{ij}$$

where $\frac{\varepsilon_{kk}}{3}$ is called the mean normal strain, and ε_{kk} is called the dilatation or volume strain (change in volume per unit initial volume)

$$\varepsilon_{kk} = \frac{V - V_0}{V_0}$$

Roughly speaking, a typical convention may refer to the relation $\sigma'_{ij} = f(\varepsilon'_{ij})$ as a “constitutive equation”, and $P = f(\mu, e_{V0})$ as an EOS. The use of an EOS may be omitted only when volumetric deformation is very small, and $|P| \ll |\sigma'_{ij}|$.

***EOS_LINEAR_POLYNOMIAL**

This is Equation of state Form 1.

Purpose: Define coefficients for a linear polynomial EOS, and initialize the thermodynamic state of the material by defining E0 and V0 below.

Card 1	1	2	3	4	5	6	7	8
Variable	EOSID	C0	C1	C2	C3	C 4	C5	C6
Type	A8	F	F	F	F	F	F	F

Card 2	1	2	3	4	5	6	7	8
Variable	E0	V0						
Type	F	F						

VARIABLE	DESCRIPTION
EOSID	Equation of state ID, a unique number or label not exceeding 8 characters must be specified.
C0	The 0 th polynomial equation coefficient.
C1	The 1 st polynomial equation coefficient (when used by itself, this is the elastic bulk modulus, i.e. it cannot be used for deformation that is beyond the elastic regime).
:	:
C6	The 6 th polynomial equation coefficient.
E0	Initial internal energy per unit reference volume (see the beginning of the *EOS section).
V0	Initial relative volume (see the beginning of the *EOS section).

Remarks:

1. The linear polynomial equation of state is linear in internal energy. The pressure is given by:

$$P = C_0 + C_1\mu + C_2\mu^2 + C_3\mu^3 + (C_4 + C_5\mu + C_6\mu^2)E.$$

where terms $C_2\mu^2$ and $C_6\mu^2$ are set to zero if $\mu < 0$, $\mu = \frac{\rho}{\rho_0} - 1$, and $\frac{\rho}{\rho_0}$ is the ratio of current density to reference density. ρ is a nominal or reference density defined in the *MAT_NULL card.

The linear polynomial equation of state may be used to model gas with the gamma law equation of state. This may be achieved by setting:

$$C_0 = C_1 = C_2 = C_3 = C_6 = 0$$

and

$$C_4 = C_5 = \gamma - 1$$

where

$$\gamma = \frac{C_p}{C_v}$$

is the ratio of specific heats. Pressure for a perfect gas is then given by:

$$p = (\gamma - 1) \frac{\rho}{\rho_0} E$$

E has the unit of pressure (where ρ and ρ_0)

2. When $C_0 = C_1 = C_2 = C_3 = C_6 = 0$, it does not necessarily mean that the initial pressure is zero, $P_0 \neq C_0$! The initial pressure depends the values of all the coefficients and on $\mu|_{t=0}$ and $E|_{t=0}$. The pressure in a material is computed from the whole equation above, $P = P(\mu, E)$. It is always preferable to initialize the initial condition based on $\mu|_{t=0}$ and $E|_{t=0}$. The use of $C_0 = C_1 = C_2 = C_3 = C_6 = 0$ must be done with caution as it may change the form and behavior of the material. The safest way is to use the whole EOS equation to manually check for the pressure value. For example, for ideal gas, it is wrong to define $C_4 = C_5 = \gamma - 1$ and $C_0 = C_1 = C_2 = C_3 = C_6 = 0$ at the same time.
3. V0 and E0 defined in this card must be the same as the time-zero ordinates for the 2 load curves defined in the *BOUNDARY_AMBIENT_EOS card, if it is used. This is so that they would both consistently define the same initial state for a material.

*EOS_JWL

This is Equation of state Form 2.

Card 1	1	2	3	4	5	6	7	8
Variable	EOSID	A	B	R1	R2	OMEG	E0	V0
Type	A8	F	F	F	F	F	F	F

VARIABLE**DESCRIPTION**

EOSID	Equation of state ID, a unique number or label not exceeding 8 characters must be specified.
A	See equation in Remarks.
B	See equation in Remarks.
R1	See equation in Remarks.
R2	See equation in Remarks.
OMEG	See equation in Remarks.
E0	Detonation energy per unit volume.
V0	Initial relative volume.

Remarks:

The JWL equation of state defines the pressure as

$$p = A \left(1 - \frac{\omega}{R_1 V} \right) e^{-R_1 V} + B \left(1 - \frac{\omega}{R_2 V} \right) e^{-R_2 V} + \frac{\omega E}{V},$$

and is usually used for detonation products of high explosives.

A, B, and E0 have units of pressure. R1, R2, OMEG, and V0 are unitless. It is recommended that a unit system of gram, centimeter, microsecond be used when a model includes high explosive(s). In this consistent unit system, pressure is in Mbar.

***EOS_SACK_TUESDAY**

This is Equation of state Form 3.

Card 1	1	2	3	4	5	6	7	8
Variable	EOSID	A1	A2	A3	B1	B2	E0	V0
Type	A8	F	F	F	F	F	F	F

VARIABLE**DESCRIPTION**

EOSID	Equation of state ID, a unique number or label not exceeding 8 characters must be specified.
A1	
A2	
A3	
B1	
B2	
E0	Initial internal energy
V0	Initial relative volume

Remarks:

The Sack equation of state defines pressure as

$$p = \frac{A_3}{V^{A_1}} e^{-A_2 V} \left(1 - \frac{B_1}{V} \right) + \frac{B_2}{V} E$$

and is used for detonation products of high explosives.

*EOS_GRUNEISEN

This is Equation of state Form 4.

Card 1	1	2	3	4	5	6	7	8
Variable	EOSID	C	S1	S2	S3	GAMAO	A	E0
Type	A8	F	F	F	F	F	F	F

Card 2	1	2	3	4	5	6	7	8
Variable	V0							
Type	F							

VARIABLE**DESCRIPTION**

EOSID Equation of state ID, a unique number or label not exceeding 8 characters must be specified.

C

S1

S2

S3

GAMAO

E0 Initial internal energy

V0 Initial relative volume

Remarks:

The Gruneisen equation of state with cubic shock velocity-particle velocity (v_s-v_p) defines pressure for compressed materials as

$$p = \frac{\rho_0 C^2 \mu \left[1 + \left(1 - \frac{\gamma_0}{2} \right) \mu - \frac{a}{2} \mu^2 \right]}{\left[1 - (S_1 - 1) \mu - S_2 \frac{\mu^2}{\mu + 1} - S_3 \frac{\mu^3}{(\mu + 1)^2} \right]^2} + (\gamma_0 + a\mu)E.$$

and for expanded materials as

$$p = \rho_0 C^2 \mu + (\gamma_0 + a\mu)E.$$

where C is the intercept of the v_s - v_p curve (in velocity units); S_1 , S_2 , and S_3 are the unitless coefficients of the slope of the v_s - v_p curve; γ_0 is the unitless Gruneisen gamma; a is the unitless, first order volume correction to γ_0 ; and

$$\mu = \frac{\rho}{\rho_0} - 1.$$

*EOS_RATIO_OF_POLYNOMIALS

This is Equation of state Form 5.

Card 1	1	2	3	4	5	6	7	8
Variable	EOSID							
Type	A8							

Card 2	1	2	3	4	5	6	7	8
Variable	A10		A11		A12		A13	
Type	F		F		F		F	

Card 3	1	2	3	4	5	6	7	8
Variable	A20		A21		A22		A23	
Type	F		F		F		F	

Card 4	1	2	3	4	5	6	7	8
Variable	A30		A31		A32		A33	
Type	F		F		F		F	

Card 5	1	2	3	4	5	6	7	8
Variable	A40		A41		A42		A43	
Type	F		F		F		F	

EOS**EOS_RATIO_OF_POLYNOMIALS**

Card 6	1	2	3	4	5	6	7	8
Variable	A50		A51		A52		A53	
Type	F		F		F		F	

Card 7	1	2	3	4	5	6	7	8
Variable	A60		A61		A62		A63	
Type	F		F		F		F	

Card 8	1	2	3	4	5	6	7	8
Variable	A70		A71		A72		A73	
Type	F		F		F		F	

Card 9	1	2	3	4	5	6	7	8
Variable	A14		A24					
Type	F		F					

Card 10	1	2	3	4	5	6	7	8
Variable	ALPH		BETA		E0		V0	
Type	F		F		F		F	

VARIABLE**DESCRIPTION**

EOSID

Equation of state ID, a unique number or label not exceeding 8 characters must be specified.

A10

VARIABLE	DESCRIPTION
A11	
A12	
A13	
A20	
A21	
A22	
A23	
A30	
A31	
A32	
A33	
A40	
A41	
A42	
A43	
A50	
A51	
A52	
A53	
A60	
A61	
A62	
A63	
A70	

VARIABLE	DESCRIPTION
A71	
A72	
A73	
A14	
A24	
ALPHA	α
BETA	β
E0	Initial internal energy
V0	Initial relative volume

Remarks:

The ratio of polynomials equation of state defines the pressure as

$$p = \frac{F_1 + F_2E + F_3E^2 + F_4E^3}{F_5 + F_6E + F_7E^2} (1 + \alpha\mu)$$

where

$$F_i = \sum_{j=0}^n A_{ij}^j \mu^j \quad \text{with } n = \begin{cases} 4 & i < 3 \\ 3 & i \geq 3 \end{cases}$$

$$\mu = \frac{\rho}{\rho_0} - 1$$

In expanded elements F_1 is replaced by $F'_1 = F_1 + \beta\mu^2$. By setting coefficient $A_{10} = 1.0$, the delta-phase pressure modeling for this material will be initiated. The code will reset it to 0.0 after setting flags.

***EOS_LINEAR_POLYNOMIAL_WITH_ENERGY_LEAK**

This is Equation of state Form 6.

Purpose: Define coefficients for a linear polynomial EOS, and initialize the thermodynamic state of the material by defining E0 and V0 below. Energy deposition is prescribed via a curve.

Card 1	1	2	3	4	5	6	7	8
Variable	EOSID	C0	C1	C2	C3	C4	C5	C6
Type	A8	F	F	F	F	F	F	F

Card 2	1	2	3	4	5	6	7	8
Variable	E0	V0	LCID					
Type	F	F	I					

VARIABLE	DESCRIPTION
EOSID	Equation of state ID, a unique number or label not exceeding 8 characters must be specified.
C0	
C1	
C2	
C3	
C4	
C5	
C6	
E0	Initial internal energy
V0	Initial relative volume

VARIABLE	DESCRIPTION
LCID	Load curve ID defining the energy deposition rate.

Remarks:

This polynomial equation of state, linear in the internal energy per initial volume, E , is given by

$$p = C_0 + C_1\mu + C_2\mu^2 + C_3\mu^3 + (C_4 + C_5\mu + C_6\mu^2)E$$

in which C_0 , C_1 , C_2 , C_3 , C_4 , C_5 , and C_6 are user defined constants and

$$\mu = \frac{1}{V} - 1 .$$

where V is the relative volume. In expanded elements, we set the coefficients of μ^2 to zero, i.e.,

$$C_2 = C_6 = 0$$

Internal energy, E , is increased according to an energy deposition rate versus time curve whose ID is defined in the input.

***EOS_IGNITION_AND_GROWTH_OF_REACTION_IN_HE**

This is Equation of state Form 7.

Card 1	1	2	3	4	5	6	7	8
Variable	EOSID	A	B	XP1	XP2	FRER	G	R1
Type	A8	F	F	F	F	F	F	F

Card 2	1	2	3	4	5	6	7	8
Variable	R2	R3	R5	R6	FMXIG	FREQ	GROW1	EM
Type	F	F	F	F	F	F	F	F

Card 3	1	2	3	4	5	6	7	8
Variable	AR1	ES1	CVP	CVR	EETAL	CCRIT	ENQ	TMP0
Type	F	F	F	F	F	F	F	F

Card 4	1	2	3	4	5	6	7	8
Variable	GROW2	AR2	ES2	EN	FMXGR	FMNGR		
Type	F	F	F	F	F	F		

VARIABLE**DESCRIPTION**

EOSID	Equation of state ID, a unique number or label not exceeding 8 characters must be specified.
A	Product JWL constant (see second equation in Remarks)
B	Product JWL constant (see second equation in Remarks)
XP1	Product JWL constant (see second equation in Remarks)

VARIABLE	DESCRIPTION
XP2	Product JWL constant (see second equation in Remarks)
FRER	Constant in ignition term of reaction equation
G	ωC_v of product
R1	Unreacted JWL constant (see first equation in Remarks)
R2	Unreacted JWL constant (see first equation in Remarks)
R3	ωC_v of unreacted explosive
R5	Unreacted JWL constant (see first equation in Remarks)
R6	Unreacted JWL constant (see first equation in Remarks)
FMXIG	Maximum F for ignition term
FREQ	Constant in ignition term of reaction equation
GROW1	Constant in growth term of reaction equation
EM	Constant in growth term of reaction equation
AR1	Constant in growth term of reaction equation
ES1	Constant in growth term of reaction equation
CVP	Heat capacity of reaction products
CVR	Heat capacity of unreacted HE
EETAL	Constant in ignition term of reaction equation
CCRIT	Constant in ignition term of reaction equation
ENQ	Heat of reaction
TMP0	Initial temperature ($^{\circ}K$)
GROW2	Constant in completion term of reaction equation
AR2	Constant in completion term of reaction equation
ES2	Constant in completion term of reaction equation

VARIABLE	DESCRIPTION
EN	Constant in completion term of reaction equation
FMXGR	Maximum F for growth term
FMNGR	Maximum F for completion term

Remarks:

Equation of State Form 7 is used to calculate the shock initiation (or failure to initiate) and detonation wave propagation of solid high explosives. It should be used instead of the ideal HE burn options whenever there is a question whether the HE will react, there is a finite time required for a shock wave to build up to detonation, and/or there is a finite thickness of the chemical reaction zone in a detonation wave. At relatively low initial pressures (<2-3 GPa), this equation of state should be used with material type 10 for accurate calculations of the unreacted HE behavior. At higher initial pressures, material type 9 can be used. A JWL equation of state defines the pressure in the unreacted explosive as

$$P_e = r_1 e^{-r_5 V_e} + r_2 e^{-r_6 V_e} + r_3 \frac{T_e}{V_e}, \quad (r_3 = \omega_e c v r)$$

where V_e and T_e are the relative volume and temperature, respectively, of the unreacted explosive. Another JWL equation of state defines the pressure in the reaction products as

$$P_p = a e^{-x p 1 V_p} + b e^{-x p 2 V_p} + \frac{g T_p}{V_p}, \quad (g = \omega_p c v p)$$

where V_p and T_p are the relative volume and temperature, respectively, of the reaction products. As the chemical reaction converts unreacted explosive to reaction products, these JWL equations of state are used to calculate the mixture of unreacted explosive and reaction products defined by the fraction reacted F ($F = 0$ implies no reaction, $F = 1$ implies complete reaction). The temperatures and pressures are assumed to be equal ($T_e = T_p, p_e = p_p$) and the relative volumes are additive, i.e.,

$$V = (1 - F)V_e + FV_p$$

The chemical reaction rate for conversion of unreacted explosive to reaction products consists of three physically realistic terms: an ignition term in which a small amount of explosive reacts soon after the shock wave compresses it; a slow growth of reaction as this initial reaction spreads; and a rapid completion of reaction at high pressure and temperature. The form of the reaction rate equation is

$$\frac{\partial F}{\partial t} = \underbrace{\frac{\text{Ignition}}{\text{FREQ} \times (1 - F)^{\text{FRER}} (V_e^{-1} - 1 - \text{CCRIT})^{\text{EETAL}}}}_{\text{Ignition}} + \underbrace{\frac{\text{Growth}}{\text{GROW1} \times (1 - F)^{\text{ES1}} F^{\text{AR1}} p^{\text{EM}}}}_{\text{Growth}} + \underbrace{\frac{\text{GROW2} \times (1 - F)^{\text{ES2}} f^{\text{AR2}} p^{\text{EN}}}{\text{Completion}}}_{\text{Completion}}$$

The ignition rate is set equal to zero when $F \geq \text{FMXIG}$, the growth rate is set equal to zero when $F \geq \text{FMXGR}$, and the completion rate is set equal to zero when $F \leq \text{FMNGR}$.

Details of the computational methods and many examples of one and two dimensional shock initiation and detonation wave calculation can be found in the references (Cochran and Chan [1979], Lee and Tarver [1980]). Unfortunately, sufficient experimental data has been obtained for only two solid explosives to develop very reliable shock initiation models: PBX-9504 (and the related HMX-based explosives LX-14,LX-10,LX-04, etc.) and LX-17 (the insensitive TATB-based explosive). Reactive flow models have been developed for other explosives (TNT, PETN, Composition B, propellants, etc.) but are based on very limited experimental data.

When this EOS is used with *MAT_009, history variables 4, 7, 9, and 10 are temperature, burn fraction, $1/V_e$, and $1/V_p$, respectively. When used with *MAT_010, those history variables are incremented by 1, i.e., history variables 5, 8, 10, and 11 are temperature, burn fraction, $1/V_e$, and $1/V_p$, respectively. See NEIPH in *DATABASE_EXTENT_BINARY if these output variables are desired in the databases for post-processing.

*EOS_TABULATED_COMPACION

This is Equation of state Form 8.

Card 1	1	2	3	4	5	6	7	8
Variable	EOSID	GAMA	E0	V0				
Type	A8	F	F	F				

Parameter Card Pairs. Include one pair of the following two cards for each of $VAR = \varepsilon_{Vi}$, C_i , T_i , and K_i . These cards consist of four additional pairs for a total of 8 additional cards.

Card 3	1	2	3	4	5	6	7	8	9	10
Variable	[VAR]1		[VAR]2		[VAR]3		[VAR]4		[VAR]5	
Type	F		F		F		F		F	

Card 4	1	2	3	4	5	6	7	8	9	10
Variable	[VAR]6		[VAR]7		[VAR]8		[VAR]9		[VAR]10	
Type	F		F		F		F		F	

VARIABLE**DESCRIPTION**

EOSID	Equation of state ID, a unique number or label not exceeding 8 characters must be specified.
$\varepsilon_{V1}, \varepsilon_{V1}, \dots, \varepsilon_{VN}$	Volumetric strain, $\ln V$
C_1, C_2, \dots, C_N	$C(\varepsilon_V)$, see EOS
T_1, T_2, \dots, T_N	$T(\varepsilon_V)$, see EOS
K_1, K_2, \dots, K_N	Bulk unloading modulus
GAMA	γ , see EOS
E0	Initial internal energy

VARIABLE	DESCRIPTION
----------	-------------

V0	Initial relative volume
----	-------------------------

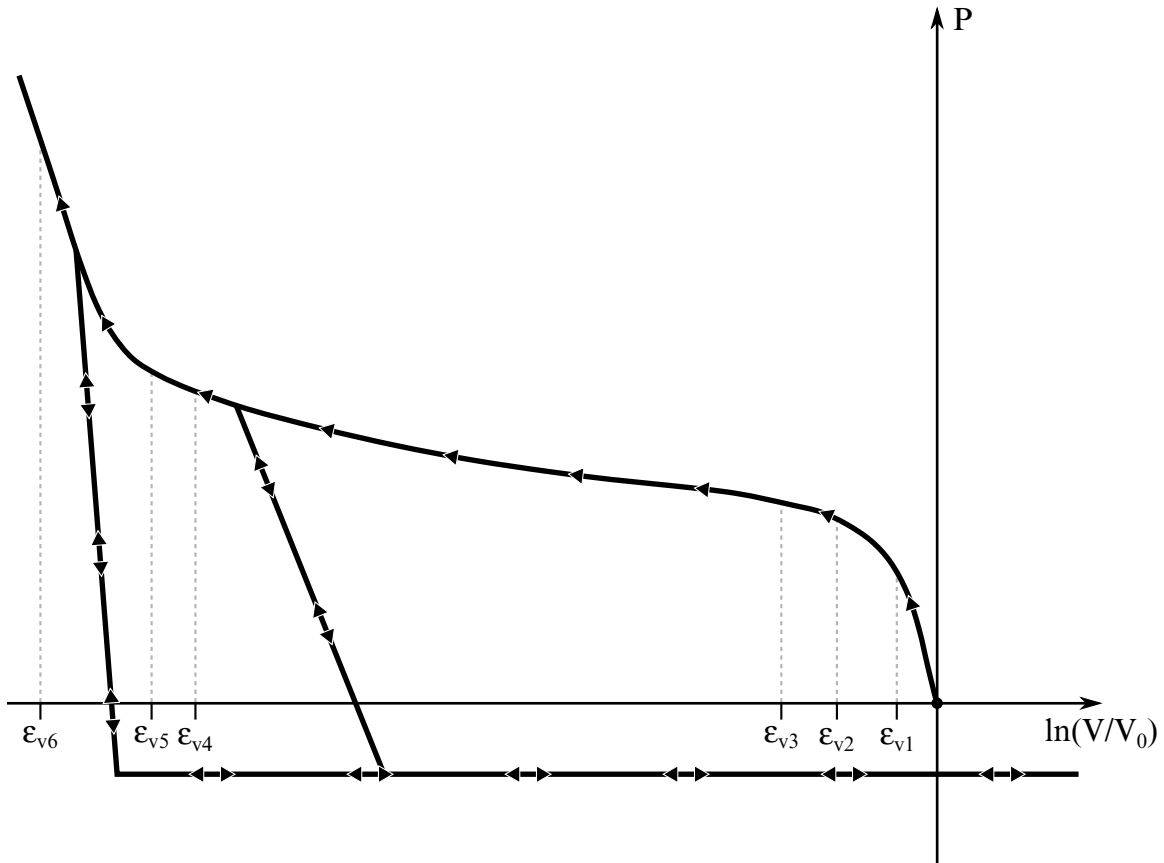

Figure 1-1. Pressure versus volumetric strain curve for Equation of state Form 8 with compaction. In the compacted states the bulk unloading modulus depends on the peak volumetric strain. Volumetric strain values should be input with correct sign (negative in compression) and in descending order. Pressure is positive in compression.

Remarks:

The tabulated compaction model is linear in internal energy. Pressure is defined by

$$p = C(\epsilon_V) + \gamma T(\epsilon_V)E$$

in the loading phase. The volumetric strain, ϵ_V is given by the natural logarithm of the relative volume V . Unloading occurs along the unloading bulk modulus to the pressure cutoff. Reloading always follows the unloading path to the point where unloading began, and continues on the loading path, see [Figure 1-1](#). Up to 10 points and as few as 2 may be used when defining the tabulated functions. LS-DYNA will extrapolate to find the pressure if necessary.

*EOS_TABULATED

This is Equation of state Form 9.

Card 1	1	2	3	4	5	6	7	8
Variable	EOSID	GAMA	E0	V0	LCC	LCT		
Type	A8	F	F	F	I	I		

Parameter Card Pairs. Include one pair of the following two cards for each of $VAR = \varepsilon_{vi}$, C_i , T_i . These cards consist of three additional pairs for a total of 6 additional cards.

Card 2	1	2	3	4	5	6	7	8	9	10
Variable	[VAR]1		[VAR]2		[VAR]3		[VAR]4		[VAR]5	
Type	F		F		F		F		F	

Card 3	1	2	3	4	5	6	7	8	9	10
Variable	[VAR]6		[VAR]7		[VAR]8		[VAR]9		[VAR]10	
Type	F		F		F		F		F	

VARIABLE**DESCRIPTION**

EOSID	Equation of state ID, a unique number or label not exceeding 8 characters must be specified.
GAMA	γ
E0	Initial internal energy
V0	Initial relative volume
LCC	Load curve defining tabulated function C. See equation in Remarks. The abscissa values of LCC and LCT must <i>increase</i> monotonically. The definition can extend into the tensile regime.

VARIABLE	DESCRIPTION
LCT	Load curve defining tabulated function T. See equation in Remarks.
$\varepsilon_{V1}, \varepsilon_{V2}, \dots, \varepsilon_{VN}$	Volumetric strain, $\ln(V)$, where V is the relative volume. The first abscissa point, EV1, must be 0.0 or positive if the curve extends into the tensile regime with subsequent points <i>decreasing</i> monotonically.
C_1, C_2, \dots, C_N	Tabulated points for function C.
T_1, T_2, \dots, T_N	Tabulated points for function T.

Remarks:

The tabulated equation of state model is linear in internal energy. Pressure is defined by

$$P = C(\varepsilon_V) + \gamma T(\varepsilon_V)E$$

The volumetric strain, ε_V is given by the natural logarithm of the relative volume V. Up to 10 points and as few as 2 may be used when defining the tabulated functions. LS-DYNA will extrapolate to find the pressure if necessary.

***EOS_PROPELLANT_DEFLAGRATION**

This Equation of state (10) has been added to model airbag propellants.

Card 1	1	2	3	4	5	6	7	8
Variable	EOSID	A	B	XP1	XP2	FRER		
Type	A8	F	F	F	F	F		

Card 2	1	2	3	4	5	6	7	8
Variable	G	R1	R2	R3	R5			
Type	F	F	F	F	F			

Card 3	1	2	3	4	5	6	7	8
Variable	R6	FMXIG	FREQ	GROW1	EM			
Type	F	F	F	F	F			

Card 4	1	2	3	4	5	6	7	8
Variable	AR1	ES1	CVP	CVR	EETAL	CCRIT	ENQ	TMP0
Type	F	F	F	F	F			

Card 5	1	2	3	4	5	6	7	8
Variable	GROW2	AR2	ES2	EN	FMXGR	FMNGR		
Type	F	F	F	F	F	F		

VARIABLE	DESCRIPTION
EOSID	Equation of state ID, a unique number or label not exceeding 8 characters must be specified.
A	Product JWL coefficient
B	Product JWL coefficient
XP1	Product JWL coefficient
XP2	Product JWL coefficient
FRER	Unreacted Co-volume
G	Product ωC_v
R1	Unreacted JWL coefficient
R2	Unreacted JWL coefficient
R3	Unreacted ωC_v
R5	Unreacted JWL coefficient
R6	Unreacted JWL coefficient
FMXIG	Initial Fraction Reacted F_o
FREQ	Initial Pressure P_o
GROW1	First burn rate coefficient
EM	Pressure Exponent (1 st term)
AR1	Exponent on F (1 st term)
ES1	Exponent on (1 - F) (1 st term)
CVP	Heat capacity C_v for products
CVR	Heat capacity C_v for unreacted material
EETAL	Extra, not presently used
CCRIT	Product co-volume
ENQ	Heat of Reaction

VARIABLE	DESCRIPTION
TMP0	Initial Temperature (298°K)
GROW2	Second burn rate coefficient
AR2	Exponent on F (2 nd term)
ES2	Exponent on (1-F) (2 nd term)
EN	Pressure Exponent (2 nd term)
FMXGR	Maximum F for 1 st term
FMNGR	Minimum F for 2 nd term

Remarks:

A deflagration (burn rate) reactive flow model requires an unreacted solid equation of state, a reaction product equation of state, a reaction rate law and a mixture rule for the two (or more) species. The mixture rule for the standard ignition and growth model [Lee and Tarver 1980] assumes that both pressures and temperatures are completely equilibrated as the reaction proceeds. However, the mixture rule can be modified to allow no thermal conduction or partial heating of the solid by the reaction product gases. For this relatively slow process of airbag propellant burn, the thermal and pressure equilibrium assumptions are valid. The equations of state currently used in the burn model are the JWL, Gruneisen, the van der Waals co-volume, and the perfect gas law, but other equations of state can be easily implemented. In this propellant burn, the gaseous nitrogen produced by the burning sodium azide obeys the perfect gas law as it fills the airbag but may have to be modeled as a van der Waal's gas at the high pressures and temperatures produced in the propellant chamber. The chemical reaction rate law is pressure, particle geometry and surface area dependent, as are most high-pressure burn processes. When the temperature profile of the reacting system is well known, temperature dependent Arrhenius chemical kinetics can be used.

Since the airbag propellant composition and performance data are company private information, it is very difficult to obtain the required information for burn rate modeling. However, Imperial Chemical Industries (ICI) Corporation supplied pressure exponent, particle geometry, packing density, heat of reaction, and atmospheric pressure burn rate data which allowed us to develop the numerical model presented here for their $\text{NaN}_3 + \text{Fe}_2\text{O}_3$ driver airbag propellant. The deflagration model, its implementation, and the results for the ICI propellant are presented in [Hallquist, et.al., 1990].

The unreacted propellant and the reaction product equations of state are both of the form:

$$p = Ae^{-R_1V} + Be^{-R_2V} + \frac{\omega C_v T}{V - d}$$

where p is pressure (in Mbars), V is the relative specific volume (inverse of relative density), ω is the Gruneisen coefficient, C_v is heat capacity (in Mbars-cc/cc°K), T is temperature in °K, d is the co-volume, and A , B , R_1 and R_2 are constants. Setting $A = B = 0$ yields the van der Waal's co-volume equation of state. The JWL equation of state is generally useful at pressures above several kilobars, while the van der Waal's is useful at pressures below that range and above the range for which the perfect gas law holds. Of course, setting $A = B = d = 0$ yields the perfect gas law. If accurate values of ω and C_v plus the correct distribution between "cold" compression and internal energies are used, the calculated temperatures are very reasonable and thus can be used to check propellant performance.

The reaction rate used for the propellant deflagration process is of the form:

$$\frac{\partial F}{\partial t} = \underbrace{Z(1-F)^y F^x p^w}_{0 < F < F_{\text{limit1}}} + \underbrace{V(1-F)^u F^r p^s}_{F_{\text{limit2}} < F < 1}$$

where F is the fraction reacted ($F = 0$ implies no reaction, $F = 1$ is complete reaction), t is time, and p is pressure (in Mbars), r , s , u , w , x , y , F_{limit1} and F_{limit2} are constants used to describe the pressure dependence and surface area dependence of the reaction rates. Two (or more) pressure dependant reaction rates are included in case the propellant is a mixture or exhibited a sharp change in reaction rate at some pressure or temperature. Burning surface area dependencies can be approximated using the $(1-F)^y F^x$ terms. Other forms of the reaction rate law, such as Arrhenius temperature dependent $e^{-E/RT}$ type rates, can be used, but these require very accurate temperatures calculations. Although the theoretical justification of pressure dependent burn rates at kilobar type pressures is not complete, a vast amount of experimental burn rate versus pressure data does demonstrate this effect and hydrodynamic calculations using pressure dependent burn accurately simulate such experiments.

The deflagration reactive flow model is activated by any pressure or particle velocity increase on one or more zone boundaries in the reactive material. Such an increase creates pressure in those zones and the decomposition begins. If the pressure is relieved, the reaction rate decreases and can go to zero. This feature is important for short duration, partial decomposition reactions. If the pressure is maintained, the fraction reacted eventually reaches one and the material is completely converted to product molecules. The deflagration front rates of advance through the propellant calculated by this model for several propellants are quite close to the experimentally observed burn rate versus pressure curves.

To obtain good agreement with experimental deflagration data, the model requires an accurate description of the unreacted propellant equation of state, either an analytical fit to experimental compression data or an estimated fit based on previous experience with similar materials. This is also true for the reaction products equation of state. The more

experimental burn rate, pressure production and energy delivery data available, the better the form and constants in the reaction rate equation can be determined.

Therefore, the equations used in the burn subroutine for the pressure in the unreacted propellant

$$P_u = R1 \times e^{-R5 \cdot V_u} + R2 \times e^{-R6 \cdot V_u} + \frac{R3 \times T_u}{V_u - FRER}$$

where V_u and T_u are the relative volume and temperature respectively of the unreacted propellant. The relative density is obviously the inverse of the relative volume. The pressure P_p in the reaction products is given by:

$$P_p = A \times e^{-XP1 \times V_p} + B \times e^{-XP2 \times V_p} + \frac{G \times T_p}{V_p - CCRIT}$$

As the reaction proceeds, the unreacted and product pressures and temperatures are assumed to be equilibrated ($T_u = T_p = T, p = P_u = P_p$) and the relative volumes are additive:

$$V = (1 - F)V_u + FV_p$$

where V is the total relative volume. Other mixture assumptions can and have been used in different versions of DYNA2D/3D. The reaction rate law has the form:

$$\begin{aligned} \frac{\partial F}{\partial t} = & \text{GROW1} \times (P + \text{FREQ})^{\text{EM}} (F + \text{FMXIG})^{\text{AR1}} (1 - F + \text{FMIXG})^{\text{ES1}} \\ & + \text{GROW2} \times (P + \text{FREQ})^{\text{EN}} (F + \text{FMIXG})^{\text{AR2}} (1 - F + \text{FMIXG})^{\text{ES2}} \end{aligned}$$

If F exceeds FMXGR , the GROW1 term is set equal to zero, and, if F is less than FMNGR , the GROW2 term is zero. Thus, two separate (or overlapping) burn rates can be used to describe the rate at which the propellant decomposes.

This equation of state subroutine is used together with a material model to describe the propellant. In the airbag propellant case, a null material model (type #10) can be used. Material type #10 is usually used for a solid propellant or explosive when the shear modulus and yield strength are defined. The propellant material is defined by the material model and the unreacted equation of state until the reaction begins. The calculated mixture states are used until the reaction is complete and then the reaction product equation of state is used. The heat of reaction, ENQ , is assumed to be a constant and the same at all values of F but more complex energy release laws could be implemented.

History variables 4 and 7 are temperature and burn fraction, respectively. See NEIPH in $\text{*DATABASE_EXTENT_BINARY}$ if these output variables are desired in the databases for post-processing.

***EOS_TENSOR_PORE_COLLAPSE**

This is Equation of state Form 11.

Card 1	1	2	3	4	5	6	7	8
Variable	EOSID	NLD	NCR	MU1	MU2	IE0	EC0	
Type	A8	F	F	F	F	F	F	

VARIABLE	DESCRIPTION
EOSID	Equation of state ID, a unique number or label not exceeding 8 characters must be specified.
NLD	Virgin loading load curve ID
NCR	Completely crushed load curve ID
MU1	Excess Compression required before any pores can collapse
MU2	Excess Compression point where the Virgin Loading Curve and the Completely Crushed Curve intersect
IE0	Initial Internal Energy
EC0	Initial Excess Compression

Remarks:

The pore collapse model described in the TENSOR manual [23] is no longer valid and has been replaced by a much simpler method. This is due in part to the lack of experimental data required for the more complex model. It is desired to have a close approximation of the TENSOR model in the DYNA code to enable a quality link between them. The TENSOR model defines two curves, the virgin loading curve and the completely crushed curve as shown in [Figure 1-2](#) also defines the excess compression point required for pore collapse to begin (μ_1), and the excess compression point required to completely crush the material (μ_2). From this data and the maximum excess compression the material has attained (μ_{max}), the pressure for any excess compression (μ) can be determined.

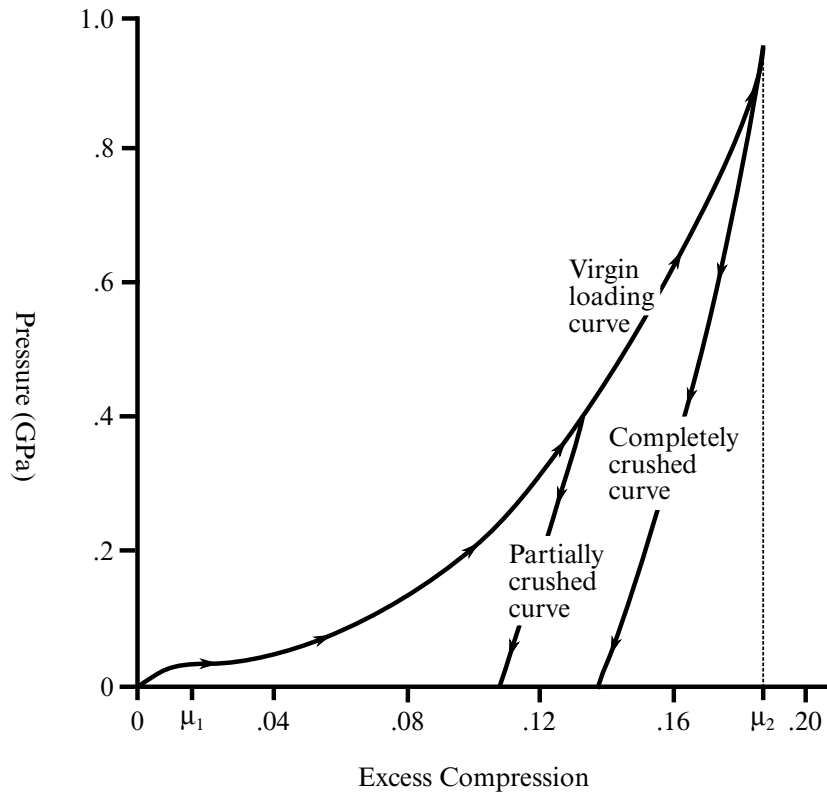

Figure 1-2. Pressure versus compaction curve

Unloading occurs along the virgin loading curve until the excess compression surpasses μ_1 . After that, the unloading follows a path between the completely crushed curve and the virgin loading curve. Reloading will follow this curve back up to the virgin loading curve. Once the excess compression exceeds μ_2 , then all unloading will follow the completely crushed curve.

For unloading between μ_1 and μ_2 a partially crushed curve is determined by the relationship:

$$p_{pc}(\mu) = p_{cc} \left[\frac{\mu_a}{(1 + \mu_B)(1 + \mu)} - 1 \right]$$

where

$$\mu_B = P_{cc}^{-1}(P_{max})$$

and the subscripts pc and cc refer to the partially crushed and completely crushed states, respectively. This is more readily understood in terms of the relative volume (V).

$$V = \frac{1}{1 + \mu}$$

$$P_{pc}(V) = P_{cc} \left(\frac{V_B}{V_{min}} V \right)$$

This representation suggests that for a fixed

$$V_{\min} = \frac{1}{\mu_{\max} + 1}$$

the partially crushed curve will separate linearly from the completely crushed curve as V increases to account for pore recovery in the material.

The bulk modulus K is determined to be the slope of the current curve times one plus the excess compression

$$K = \frac{\partial P}{\partial \mu} (1 + \mu)$$

The slope $\frac{\partial P}{\partial \mu}$ for the partially crushed curve is obtained by differentiation as:

$$\frac{\partial p_{pc}}{\partial \mu} = \frac{\partial p_{cc}}{\partial x} \Big|_{x=\frac{(1+\mu_b)(1+\mu)}{1+\mu_{\max}}-1} \left(\frac{1 + \mu_b}{1 + \mu_{\max}} \right)$$

Simplifying,

$$K = \frac{\partial P_{cc}}{\partial \mu_a} \Big|_{\mu_a} (1 + \mu_a)$$

where

$$\mu_a = \frac{(1 + \mu_B)(1 + \mu)}{(1 + \mu_{\max})} - 1.$$

The bulk sound speed is determined from the slope of the completely crushed curve at the current pressure to avoid instabilities in the time step.

The virgin loading and completely crushed curves are modeled with monotonic cubic-splines. An optimized vector interpolation scheme is then used to evaluate the cubic-splines. The bulk modulus and sound speed are derived from a linear interpolation on the derivatives of the cubic-splines.

*EOS_IDEAL_GAS

Purpose: This is equation of state form 12 for modeling ideal gas. It is an alternate approach to using *EOS_LINEAR_POLYNOMIAL with $C4 = C5 = (\gamma-1)$ to model ideal gas. This has a slightly improved energy accounting algorithm.

Card 1	1	2	3	4	5	6	7	8
Variable	EOSID	CV0	CP0	CL	CQ	T0	V0	
Type	A8	F	F	F	F	F	F	

VARIABLE**DESCRIPTION**

EOSID	Equation of state ID, a unique number or label not exceeding 8 characters must be specified.
CV0	Nominal constant-volume specific heat coefficient (at STP)
CP0	Nominal constant-pressure specific heat coefficient (at STP)
CL	Linear coefficient for the variations of Cv and Cp versus T
CQ	Quadratic coefficient for the variations of Cv and Cp versus T
T0	Initial temperature
V0	Initial relative volume (see the beginning of the *EOS section)

Remarks:

1. The pressure in the ideal gas law is defined as

$$p = \rho(C_p - C_v)T$$

$$C_p = C_{p0} + C_L T + C_Q T^2$$

$$C_v = C_{v0} + C_L T + C_Q T^2$$

where C_p and C_v are the specific heat capacities at constant pressure and at constant volume, respectively. ρ is the density. The relative volume is defined as

$$v_r = \frac{V}{V_0} = \frac{(V/M)}{(V_0/M)} = \frac{v}{v_0} = \frac{\rho_0}{\rho}$$

where ρ_0 is a nominal or reference density defined in the *MAT_NULL card. The initial pressure can then be manually computed as

$$P|_{t=0} = \rho|_{t=0}(C_P - C_V)T|_{t=0}$$
$$\rho|_{t=0} = \left\{ \frac{\rho_0}{v_r|_{t=0}} \right\}$$
$$P|_{t=0} = \left\{ \frac{\rho_0}{v_r|_{t=0}} \right\} (C_P - C_V)T|_{t=0}$$

The initial relative volume, $v_r|_{t=0}$ (V0), initial temperature, $T|_{t=0}$ (T0), and heat capacity information are defined in the *EOS_IDEAL_GAS input. Note that the “reference” density is typically a density at a non-stressed or nominal stress state. The initial pressure should always be checked manually against simulation result.

2. When dealing with Eulerian/ALE models, the ideal gas model is implemented to preserve the adiabatic state during advection. The adiabatic state is conserved on the expense of a perfect internal energy conservation.
3. The ideal gas model is good for low density gas only. Deviation from the ideal gas behavior may be indicated by the compressibility factor defined as

$$Z = \frac{Pv}{RT}$$

When Z deviates from 1, the gas behavior deviates from ideal.

4. V0 and T0 defined in this card must be the same as the time-zero ordinates for the 2 load curves defined in the *BOUNDARY_AMBIENT_EOS card, if it is used. This is so that they both would consistently define the same initial state for a material.

***EOS_JWL**

This is Equation of state Form 14. The JWL (Jones-Wilkens-Lee-Baker) equation of state, developed by Baker [1991] and further described by Baker and Orosz [1991], describes the high pressure regime produced by overdriven detonations while retaining the low pressure expansion behavior required for standard acceleration modeling. The derived form of the equation of state is based on the JWL form due to its computational robustness and asymptotic approach to an ideal gas at high expansions. Additional exponential terms and a variable Gruneisen parameter have been added to adequately describe the high-pressure region above the Chapman-Jouguet state.

Card 1	1	2	3	4	5	6	7	8
Variable	EOSID	A1	A2	A3	A4	A5		
Type	A8	F	F	F	F	F		

Card 2	1	2	3	4	5	6	7	8
Variable	R1	R2	R3	R4	R5			
Type	F	F	F	F	F			

Card 3	1	2	3	4	5	6	7	8
Variable	AL1	AL2	AL3	AL4	AL5			
Type	F	F	F	F	F			

Card 4	1	2	3	4	5	6	7	8
Variable	BL1	BL2	BL3	BL4	BL5			
Type	F	F	F	F	F			

Card 5	1	2	3	4	5	6	7	8
Variable	RL1	RL2	RL3	RL4	RL5			
Type	F	F	F	F	F			

Card 6	1	2	3	4	5	6	7	8
Variable	C	OMEGA	E	V0				
Type	I	F	F	F				

VARIABLE**DESCRIPTION**

EOSID	Equation of state ID, a unique number or label not exceeding 8 characters must be specified.
A1	Equation of state coefficient, see below.
A2	Equation of state coefficient, see below.
A3	Equation of state coefficient, see below.
A4	Equation of state coefficient, see below.
A5	Equation of state coefficient, see below.
R1	Equation of state coefficient, see below.
R2	Equation of state coefficient, see below.
R3	Equation of state coefficient, see below.
R4	Equation of state coefficient, see below.
R5	Equation of state coefficient, see below.
AL1	$A_{\lambda 1}$, equation of state coefficient, see below.
AL2	$A_{\lambda 2}$, equation of state coefficient, see below.
AL3	$A_{\lambda 3}$, equation of state coefficient, see below.
AL4	$A_{\lambda 4}$, equation of state coefficient, see below.

VARIABLE	DESCRIPTION
AL5	$A_{\lambda 5}$, equation of state coefficient, see below.
BL1	$B_{\lambda 1}$, equation of state coefficient, see below.
BL2	$B_{\lambda 2}$, equation of state coefficient, see below.
BL3	$B_{\lambda 3}$, equation of state coefficient, see below.
BL4	$B_{\lambda 4}$, equation of state coefficient, see below.
BL5	$B_{\lambda 5}$, equation of state coefficient, see below.
RL1	$R_{\lambda 1}$, equation of state coefficient, see below.
RL2	$R_{\lambda 2}$, equation of state coefficient, see below.
RL3	$R_{\lambda 3}$, equation of state coefficient, see below.
RL4	$R_{\lambda 4}$, equation of state coefficient, see below.
RL5	$R_{\lambda 5}$, equation of state coefficient, see below.
C	Equation of state coefficient, see below.
OMEGA	Equation of state coefficient, see below.
E	Energy density per unit initial volume
V0	Initial relative volume.

Remarks:

The JWL equation-of-state defines the pressure as

$$p = \sum_{i=1}^5 A_i \left(1 - \frac{\lambda}{R_i V}\right) e^{-R_i V} + \frac{\lambda E}{V} + C \left(1 - \frac{\lambda}{\omega}\right) V^{-(\omega+1)}$$

$$\lambda = \sum_{i=1}^5 (A_{\lambda i} V + B_{\lambda i}) e^{-R_{\lambda i} V} + \omega$$

where V is the relative volume, E is the energy per unit initial volume, and A_i , R_i , $A_{\lambda i}$, $B_{\lambda i}$, $R_{\lambda i}$, C, and ω are input constants defined above.

JWL input constants for some common explosives as found in Baker and Stiel [1997] are given in the following table.

	TATB	LX-14	PETN	TNT	Octol 70/30
ρ_0 (g/cc)	1.800	1.821	1.765	1.631	1.803
E0 (Mbar)	.07040	.10205	.10910	.06656	.09590
DCJ (cm/ μ s)	.76794	.86619	.83041	.67174	.82994
PCJ (Mbar)	.23740	.31717	.29076	.18503	.29369
A1 (Mbar)	550.06	549.60	521.96	490.07	526.83
A2 (Mbar)	22.051	64.066	71.104	56.868	60.579
A3 (Mbar)	.42788	2.0972	4.4774	.82426	.91248
A4 (Mbar)	.28094	.88940	.97725	.00093	.00159
R1	16.688	34.636	44.169	40.713	52.106
R2	6.8050	8.2176	8.7877	9.6754	8.3998
R3	2.0737	20.401	25.072	2.4350	2.1339
R4	2.9754	2.0616	2.2251	.15564	.18592
C (Mbar)	.00776	.01251	.01570	.00710	.00968
ω	.27952	.38375	.32357	.30270	.39023
A λ 1	1423.9	18307.	12.257	.00000	.011929
B λ 1	14387.	1390.1	52.404	1098.0	18466.
R λ 1	19.780	19.309	43.932	15.614	20.029
A λ 2	5.0364	4.4882	8.6351	11.468	5.4192
B λ 2	-2.6332	-2.6181	-4.9176	-6.5011	-3.2394
R λ 2	1.7062	1.5076	2.1303	2.1593	1.5868

*EOS_GASKET

This is Equation of state Form 15. This EOS works with solid elements and the thick shell using selective reduced 2 x 2 integration (ELFORM = 2 on SECTION_TSHELL) to model the response of gaskets. For the thick shell only, it is completely decoupled from the shell material, i.e., in the local coordinate system of the shell, this model defines the normal stress, σ_{zz} , and doesn't change any of the other stress components. The model is a reduction of the *MAT_GENERAL_NONLINEAR_6DOF_DISCRETE_BEAM.

Card 1	1	2	3	4	5	6	7	8
Variable	EOSID	LCID1	LCID2	LCID3	LCID4			
Type	A8	I	I	I	I			

Card 2	1	2	3	4	5	6	7	8
Variable	UNLOAD	K	DMPF	TFS	CFS	LOFFSET	IVS	
Type	F	F	F	F	F	F	F	

VARIABLE	DESCRIPTION
EOSID	Equation of state ID, a unique number or label not exceeding 8 characters must be specified.
LCID1	Load curve for loading.
LCID2	Load curve for unloading.
LCID3	Load curve for damping as a function of volumetric strain rate.
LCID4	Load curve for scaling the damping as a function of the volumetric strain.

VARIABLE	DESCRIPTION
UNLOAD	Unloading option (see Figure 1-3): EQ.0.0: Loading and unloading follow loading curve EQ.1.0: Loading follows loading curve, unloading follows unloading curve. The unloading curve ID if undefined is taken as the loading curve. EQ.2.0: Loading follows loading curve, unloading follows unloading stiffness, K, to the unloading curve. The loading and unloading curves may only intersect at the origin of the axes. EQ.3.0: Quadratic unloading from peak displacement value to a permanent offset.
K	Unloading stiffness, for UNLOAD = 2 only.
DMPF	Damping factor for stability. Values in the neighborhood of unity are recommended. The damping factor is properly scaled to eliminate time step size dependency.
TFS	Tensile failure strain.
CFS	Compressive failure strain.
OFFSET	Offset factor between 0 and 1.0 to determine permanent set upon unloading if the UNLOAD = 3.0. The permanent sets in compression and tension are equal to the product of this offset value and the maximum compressive and tensile displacements, respectively.
IVS	Initial volume strain.

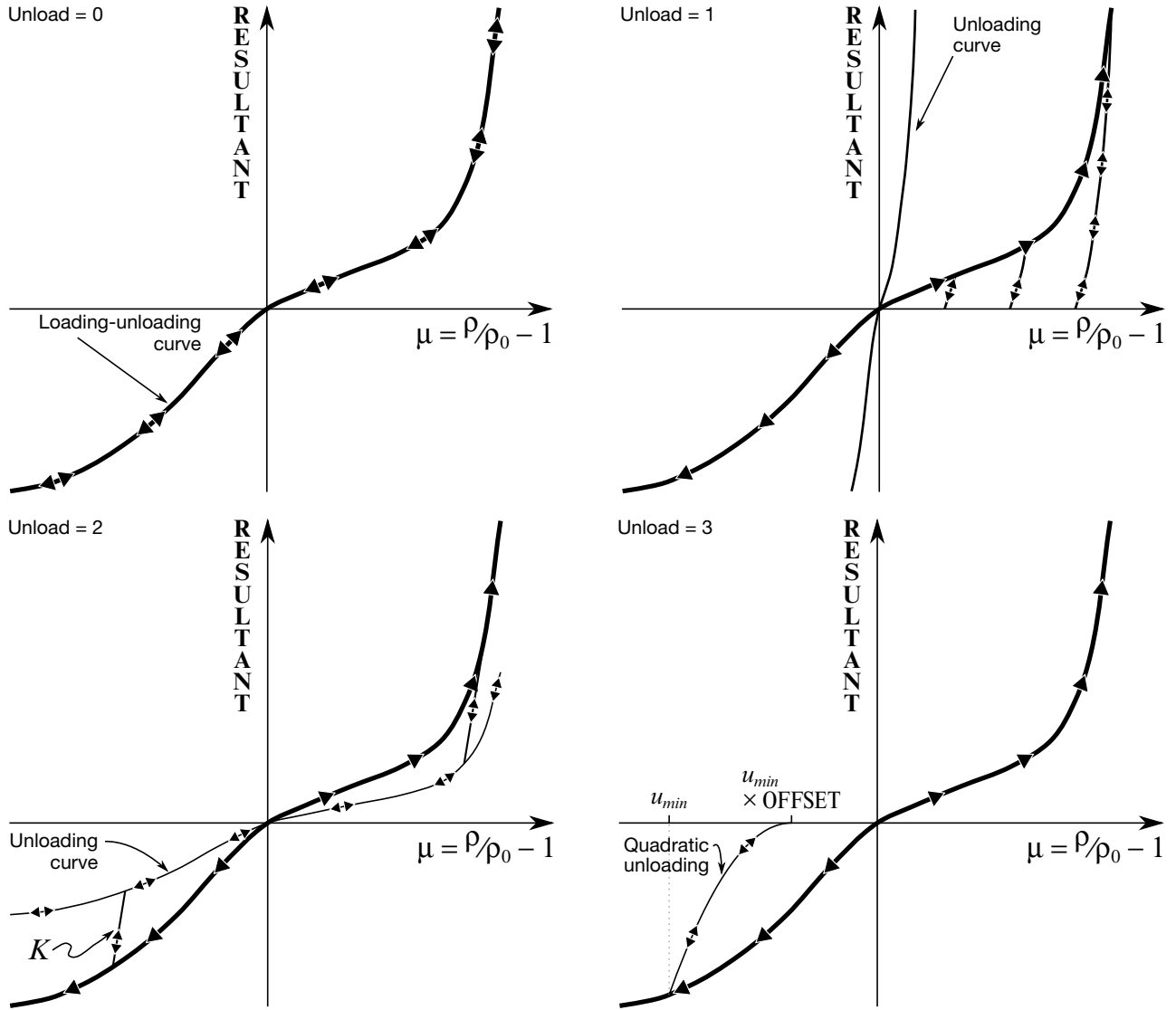

Figure 1-3. Load and unloading behavior.

***EOS_MIE_GRUNEISEN**

This is Equation of state Form 16, a Mie-Gruneisen form with a p- α compaction model.

Card 1	1	2	3	4	5	6	7	8
Variable	EOSID	GAMMA	A1	A2	A3	PEL	PCO	N
Type	A8	F	F	F	F	F	F	F
Default	none	none	none	none	none	none	none	none

Card 2	1	2	3	4	5	6	7	8
Variable	ALPHA0	E0	V0					
Type	F	F	F					
Default	none	none	none					

VARIABLE**DESCRIPTION**

EOSID	Equation of state identification. A unique number or label not exceeding 8 characters must be specified.
GAMMA	Gruneisen gamma.
A1	Hugoniot polynomial coefficient
A2	Hugoniot polynomial coefficient
A3	Hugoniot polynomial coefficient
PEL	Crush pressure
PCO	Compaction pressure
N	Porosity exponent
ALPHA0	Initial porosity
E0	Initial internal energy

VARIABLE	DESCRIPTION
V0	Initial relative volume

Remarks:

The equation of state is a Mie-Gruneisen form with a polynomial Hugoniot curve and a p- α compaction model. First, we define a history variable representing the porosity α that is initialised to $\alpha_0 > 1$. The evolution of this variable is given as

$$\alpha(t) = \max \left\{ 1, \min \left[\alpha_0, \min_{s \leq t} \left(1 + (\alpha_0 - 1) \left[\frac{p_{\text{comp}} - p(s)}{p_{\text{comp}} - p_{el}} \right]^N \right) \right] \right\}$$

where $p(t)$ indicates the pressure at time t . For later use, we define the cap pressure as

$$p_c = p_{\text{comp}} - (p_{\text{comp}} - p_{el}) \left[\frac{\alpha - 1}{\alpha_0 - 1} \right]^{1/N}$$

The remainder of the EOS model is given by the equations

$$p(\rho, e) = \Gamma \alpha \rho e + p_H(\eta) \left[1 - \frac{1}{2} \Gamma \eta \right]$$

$$p_H(\eta) = A_1 \eta + A_2 \eta^2 + A_3 \eta^3$$

together with

$$\eta(\rho) = \frac{\alpha \rho}{\alpha_0 \rho_0} - 1.$$

***EOS_USER_DEFINED**

These are equations of state 21-30. The user can supply his own subroutines. See also Appendix B. The keyword input has to be used for the user interface with data.

Card 1	1	2	3	4	5	6	7	8
Variable	EOSID	EOST	LMC	NHV	IVECT	E0	V0	BULK
Type	A8	I	I	I	I	F	F	F

Define LMC material parameters using 8 parameters per card.

Card 2	1	2	3	4	5	6	7	8
Variable	P1	P2	P3	P4	P5	P6	P7	P8
Type	F	F	F	F	F	F	F	F

VARIABLE**DESCRIPTION**

EOSID	Equation of state ID, a unique number or label not exceeding 8 characters must be specified.
EOST	User equation of state type (21-30 inclusive). A number between 21 and 30 has to be chosen.
LMC	Length of material constant array which is equal to the number of material constants to be input. ($LMC \leq 48$)
NHV	Number of history variables to be stored, see Appendix D.
IVECT	Vectorization flag (on = 1). A vectorized user subroutine must be supplied.
E0	Initial internal energy.
V0	Initial relative volume.
BULK	Bulk modulus. This value is used in the calculation of the contact surface stiffness.
P1	First material parameter.

VARIABLE	DESCRIPTION
P2	Second material parameter.
P3	Third material parameter.
P4	Fourth material parameter.
:	:
PLMC	LMCth material parameter.

*MAT

LS-DYNA has historically referenced each material model by a number. As shown below, a three digit numerical designation can still be used, e.g., *MAT_001, and is equivalent to a corresponding descriptive designation, e.g., *MAT_ELASTIC. The two equivalent commands for each material model, one numerical and the other descriptive, are listed below. The numbers in square brackets (see key below) identify the element formulations for which the material model is implemented. The number in the curly brackets, $\{n\}$, indicates the default number of history variables per element integration point that are stored in addition to the 7 history variables which are stored by default. For the type 16 fully integrated shell elements with 2 integration points through the thickness, the total number of history variables is $8 \times (n + 7)$. For the Belytschko-Tsay type 2 element the number is $2 \times (n + 7)$.

TITLE may be appended to a ***MAT** keyword in which case an additional line is read in 80a format which can be used to describe the material. At present, LS-DYNA does not make use of the title. Inclusion of titles simply gives greater clarity to input decks.

Key to numbers in square brackets

0	-	Solids
1H	-	Hughes-Liu beam
1B	-	Belytschko resultant beam
1I	-	Belytschko integrated solid and tubular beams
1T	-	Truss
1D	-	Discrete beam
1SW	-	Spotweld beam
2	-	Shells
3a	-	Thick shell formulation 1
3b	-	Thick shell formulation 2
3c	-	Thick shell formulation 3
3d	-	Thick shell formulation 5
4	-	Special airbag element
5	-	SPH element
6	-	Acoustic solid
7	-	Cohesive solid
8A	-	Multi-material ALE solid (validated)
8B	-	Multi-material ALE solid (implemented but not validated ¹)
9	-	Membrane element

¹ Error associated with advection inherently leads to state variables that may be inconsistent with nonlinear constitutive routines and thus may lead to nonphysical results, nonconservation of energy, and even numerical instability in some cases. Caution is advised, particularly when using the 2nd tier of material models implemented for ALE multi-material solids (designated by [8B]) which are largely untested as ALE materials.

*MAT

*MAT_ADD_COHESIVE [7] {see associated material model}
*MAT_ADD_EROSION²
*MAT_ADD_PERMEABILITY
*MAT_ADD_PORE_AIR
*MAT_ADD_THERMAL_EXPANSION²
*MAT_NONLOCAL²

*MAT_001: *MAT_ELASTIC [0,1H,1B,1I,1T,2,3abcd,5,8A] {0}
*MAT_001_FLUID: *MAT_ELASTIC_FLUID [0,8A] {0}
*MAT_002: *MAT_{OPTION}TROPIC_ELASTIC [0,2,3abc] {15}
*MAT_003: *MAT_PLASTIC_KINEMATIC [0,1H,1I,1T,2,3abcd,5,8A] {5}
*MAT_004: *MAT_ELASTIC_PLASTIC_THERMAL [0,1H,1T,2,3abcd,5,8B] {3}
*MAT_005: *MAT_SOIL_AND_FOAM [0,5,3cd,8A] {0}
*MAT_006: *MAT_VISCOELASTIC [0,1H,2,3abcd,5,8B] {19}
*MAT_007: *MAT_BLATZ-KO_RUBBER [0,2,3abc,8B] {9}
*MAT_008: *MAT_HIGH_EXPLOSIVE_BURN [0,5,3cd,8A] {4}
*MAT_009: *MAT_NULL [0,1,2,3cd,5,8A] {3}
*MAT_010: *MAT_ELASTIC_PLASTIC_HYDRO_{OPTION} [0,3cd,5,8B] {4}
*MAT_011: *MAT_STEINBERG [0,3cd,5,8B] {5}
*MAT_011_LUND: *MAT_STEINBERG_LUND [0,3cd,5,8B] {5}
*MAT_012: *MAT_ISOTROPIC_ELASTIC_PLASTIC [0,2,3abcd,5,8B] {0}
*MAT_013: *MAT_ISOTROPIC_ELASTIC_FAILURE [0,3cd,5,8B] {1}
*MAT_014: *MAT_SOIL_AND_FOAM_FAILURE [0,3cd,5,8B] {1}
*MAT_015: *MAT_JOHNSON_COOK [0,2,3abcd,5,8A] {6}
*MAT_016: *MAT_PSEUDO_TENSOR [0,3cd,5,8B] {6}
*MAT_017: *MAT_ORIENTED_CRACK [0,3cd] {10}
*MAT_018: *MAT_POWER_LAW_PLASTICITY [0,1H,2,3abcd,5,8B] {0}
*MAT_019: *MAT_STRAIN_RATE_DEPENDENT_PLASTICITY [0,2,3abcd,5,8B] {6}
*MAT_020: *MAT_RIGID [0,1H,1B,1T,2,3ab] {0}
*MAT_021: *MAT_ORTHOTROPIC_THERMAL [0,2,3abc] {29}
*MAT_022: *MAT_COMPOSITE_DAMAGE [0,2,3abcd,5] {12}
*MAT_023: *MAT_TEMPERATURE_DEPENDENT_ORTHOTROPIC [0,2,3abc] {19}
*MAT_024: *MAT_PIECEWISE_LINEAR_PLASTICITY [0,1H,2,3abcd,5,8A] {5}
*MAT_025: *MAT_GEOLOGIC_CAP_MODEL [0,3cd,5] {12}
*MAT_026: *MAT_HONEYCOMB [0,3cd] {20}
*MAT_027: *MAT_MOONEY-RIVLIN_RUBBER [0,1T,2,3c,8B] {9}
*MAT_028: *MAT_RESULTANT_PLASTICITY [1B,2] {5}
*MAT_029: *MAT_FORCE_LIMITED [1B] {30}
*MAT_030: *MAT_SHAPE_MEMORY [0,1H,2,3abc,5] {23}
*MAT_031: *MAT_FRAZER_NASH_RUBBER_MODEL [0,3c,8B] {9}
*MAT_032: *MAT_LAMINATED_GLASS [2,3ab] {0}
*MAT_033: *MAT_BARLAT_ANISOTROPIC_PLASTICITY [0,2,3abcd] {9}
*MAT_033_96: *MAT_BARLAT_YLD96 [2,3ab] {9}
*MAT_034: *MAT_FABRIC [4] {17}
*MAT_035: *MAT_PLASTIC_GREEN-NAGHDI_RATE [0,3cd,5,8B] {22}
*MAT_036: *MAT_3-PARAMETER_BARLAT [2,3abcd] {7}
*MAT_037: *MAT_TRANSVERSELY_ANISOTROPIC_ELASTIC_PLASTIC [2,3ab] {9}
*MAT_038: *MAT_BLATZ-KO_FOAM [0,2,3c,8B] {9}
*MAT_039: *MAT_FLD_TRANSVERSELY_ANISOTROPIC [2,3ab] {6}
*MAT_040: *MAT_NONLINEAR_ORTHOTROPIC [0,2,3c] {17}

² These three commands do not, by themselves, define a material model but rather can be used in certain cases to supplement material models

*MAT_041-050:	*MAT_USER_DEFINED_MATERIAL_MODELS [0,1H,1T,1D,2,3abcd,5,8B] {0}
*MAT_051:	*MAT_BAMMAN [0,2,3abcd,5,8B] {8}
*MAT_052:	*MAT_BAMMAN_DAMAGE [0,2,3abcd,5,8B] {10}
*MAT_053:	*MAT_CLOSED_CELL_FOAM [0,3cd,8B] {0}
*MAT_054-055:	*MAT_ENHANCED_COMPOSITE_DAMAGE [0,2,3cd] {20}
*MAT_057:	*MAT_LOW_DENSITY_FOAM [0,3cd,5,8B] {26}
*MAT_058:	*MAT_LAMINATED_COMPOSITE_FABRIC [2,3ab] {15}
*MAT_059:	*MAT_COMPOSITE_FAILURE_{OPTION}_MODEL [0,2,3cd,5] {22}
*MAT_060:	*MAT_ELASTIC_WITH_VISCOSITY [0,2,3abcd,5,8B] {8}
*MAT_060C:	*MAT_ELASTIC_WITH_VISCOSITY_CURVE [0,2,3abcd,5,8B] {8}
*MAT_061:	*MAT_KELVIN-MAXWELL_VISCOELASTIC [0,3cd,5,8B] {14}
*MAT_062:	*MAT_VISCOUS_FOAM [0,3cd,8B] {7}
*MAT_063:	*MAT_CRUSHABLE_FOAM [0,3cd,5,8B] {8}
*MAT_064:	*MAT_RATE_SENSITIVE_POWERLAW_PLASTICITY [0,2,3abcd,5,8B] {30}
*MAT_065:	*MAT_MODIFIED_ZERILLI_ARMSTRONG [0,2,3abcd,5,8B] {6}
*MAT_066:	*MAT_LINEAR_ELASTIC_DISCRETE_BEAM [1D] {8}
*MAT_067:	*MAT_NONLINEAR_ELASTIC_DISCRETE_BEAM [1D] {14}
*MAT_068:	*MAT_NONLINEAR_PLASTIC_DISCRETE_BEAM [1D] {25}
*MAT_069:	*MAT_SID_DAMPER_DISCRETE_BEAM [1D] {13}
*MAT_070:	*MAT_HYDRAULIC_GAS_DAMPER_DISCRETE_BEAM [1D] {8}
*MAT_071:	*MAT_CABLE_DISCRETE_BEAM [1D] {8}
*MAT_072:	*MAT_CONCRETE_DAMAGE [0,3cd,5,8B] {6}
*MAT_072R3:	*MAT_CONCRETE_DAMAGE_REL3 [0,3cd,5] {6}
*MAT_073:	*MAT_LOW_DENSITY_VISCOUS_FOAM [0,3cd,8B] {56}
*MAT_074:	*MAT_ELASTIC_SPRING_DISCRETE_BEAM [1D] {8}
*MAT_075:	*MAT_BILKHU/DUBOIS_FOAM [0,3cd,5,8B] {8}
*MAT_076:	*MAT_GENERAL_VISCOELASTIC [0,2,3abcd,5,8B] {53}
*MAT_077_H:	*MAT_HYPERELASTIC_RUBBER [0,2,3cd,5,8B] {54}
*MAT_077_O:	*MAT_OGDEN_RUBBER [0,2,3cd,8B] {54}
*MAT_078:	*MAT_SOIL_CONCRETE [0,3cd,5,8B] {3}
*MAT_079:	*MAT_HYSTERETIC_SOIL [0,3cd,5,8B] {77}
*MAT_080:	*MAT_RAMBERG-OSGOOD [0,3cd,8B] {18}
*MAT_081:	*MAT_PLASTICITY_WITH_DAMAGE [0,2,3abcd] {5}
*MAT_082(_RCDC):	*MAT_PLASTICITY_WITH_DAMAGE_ORTHO(_RCDC) [0,2,3abcd] {22}
*MAT_083:	*MAT_FU_CHANG_FOAM [0,3cd,5,8B] {54}
*MAT_084-085:	*MAT_WINFRITH_CONCRETE [0] {54}
*MAT_086:	*MAT_ORTHOTROPIC_VISCOELASTIC [2,3ab] {17}
*MAT_087:	*MAT_CELLULAR_RUBBER [0,3cd,5,8B] {19}
*MAT_088:	*MAT_MTS [0,2,3abcd,5,8B] {5}
*MAT_089:	*MAT_PLASTICITY_POLYMER [0,2,3abcd] {45}
*MAT_090:	*MAT_ACOUSTIC [6] {25}
*MAT_091:	*MAT_SOFT_TISSUE [0,2] {16}
*MAT_092:	*MAT_SOFT_TISSUE_VISCO [0,2] {58}
*MAT_093:	*MAT_ELASTIC_6DOF_SPRING_DISCRETE_BEAM [1D] {25}
*MAT_094:	*MAT_INELASTIC_SPRING_DISCRETE_BEAM [1D] {9}
*MAT_095:	*MAT_INELASTIC_6DOF_SPRING_DISCRETE_BEAM [1D] {25}
*MAT_096:	*MAT_BRITTLE_DAMAGE [0,8B] {51}
*MAT_097:	*MAT_GENERAL_JOINT_DISCRETE_BEAM [1D] {23}
*MAT_098:	*MAT_SIMPLIFIED_JOHNSON_COOK [0,1H,1B,1T,2,3abcd] {6}
*MAT_099:	*MAT_SIMPLIFIED_JOHNSON_COOK_ORTHOTROPIC_DAMAGE [0,2,3abcd] {22}
*MAT_100:	*MAT_SPOTWELD_{OPTION} [0,1SW] {6}
*MAT_100_DA:	*MAT_SPOTWELD_DAIMLERCHRYSLER [0] {6}
*MAT_101:	*MAT_GEPLASTIC_SRATE_2000a [2,3ab] {15}
*MAT_102:	*MAT_INV_HYPERBOLIC_SIN [0,3cd,8B] {15}

*MAT

*MAT_103:	*MAT_ANISOTROPIC_VISCOPLASTIC [0,2,3abcd,5] {20}
*MAT_103_P:	*MAT_ANISOTROPIC_PLASTIC [2,3abcd] {20}
*MAT_104:	*MAT_DAMAGE_1 [0,2,3abcd] {11}
*MAT_105:	*MAT_DAMAGE_2 [0,2,3abcd] {7}
*MAT_106:	*MAT_ELASTIC_VISCOPLASTIC_THERMAL [0,2,3abcd,5] {20}
*MAT_107:	*MAT_MODIFIED_JOHNSON_COOK [0,2,3abcd,5,8B] {15}
*MAT_108:	*MAT_ORTHO_ELASTIC_PLASTIC [2,3ab] {15}
*MAT_110:	*MAT_JOHNSON_HOLMQUIST_CERAMICS [0,3cd,5] {15}
*MAT_111:	*MAT_JOHNSON_HOLMQUIST_CONCRETE [0,3cd,5] {25}
*MAT_112:	*MAT_FINITE_ELASTIC_STRAIN_PLASTICITY [0,3c,5] {22}
*MAT_113:	*MAT_TRIP [2,3ab] {5}
*MAT_114:	*MAT_LAYERED_LINEAR_PLASTICITY [2,3ab] {13}
*MAT_115:	*MAT_UNIFIED_CREEP [0,2,3abcd,5] {1}
*MAT_116:	*MAT_COMPOSITE_LAYUP [2] {30}
*MAT_117:	*MAT_COMPOSITE_MATRIX [2] {30}
*MAT_118:	*MAT_COMPOSITE_DIRECT [2] {10}
*MAT_119:	*MAT_GENERAL_NONLINEAR_6DOF_DISCRETE_BEAM [1D] {62}
*MAT_120:	*MAT_GURSON [0,2,3abcd] {12}
*MAT_120_JC:	*MAT_GURSON_JC [0,2] {12}
*MAT_120_RCDC:	*MAT_GURSON_RCDC [0,2] {12}
*MAT_121:	*MAT_GENERAL_NONLINEAR_1DOF_DISCRETE_BEAM [1D] {20}
*MAT_122:	*MAT_HILL_3R [2,3ab] {8}
*MAT_123:	*MAT_MODIFIED_PIECEWISE_LINEAR_PLASTICITY [0,2,3abcd,5] {11}
*MAT_124:	*MAT_PLASTICITY_COMPRESSION_TENSION [0,1H,2,3abcd,5,8B] {7}
*MAT_125:	*MAT_KINEMATIC_HARDENING_TRANSVERSELY_ANISOTROPIC [0,2,3abcd] {11}
*MAT_126:	*MAT_MODIFIED_HONEYCOMB [0,3cd] {20}
*MAT_127:	*MAT_ARRUDA_BOYCE_RUBBER [0,3cd,5] {49}
*MAT_128:	*MAT_HEART_TISSUE [0,3c] {15}
*MAT_129:	*MAT_LUNG_TISSUE [0,3cd] {49}
*MAT_130:	*MAT_SPECIAL_ORTHOTROPIC [2] {35}
*MAT_131:	*MAT_ISOTROPIC_SMEARED_CRACK [0,5,8B] {15}
*MAT_132:	*MAT_ORTHOTROPIC_SMEARED_CRACK [0] {61}
*MAT_133:	*MAT_BARLAT_YLD2000 [2,3ab] {9}
*MAT_134:	*MAT_VISCOELASTIC_FABRIC [9]
*MAT_135:	*MAT_WTM_STM [2,3ab] {30}
*MAT_135_PLC:	*MAT_WTM_STM_PLC [2,3ab] {30}
*MAT_136:	*MAT_CORUS_VEGTER [2,3ab] {5}
*MAT_138:	*MAT_COHESIVE_MIXED_MODE [7] {0}
*MAT_139:	*MAT_MODIFIED_FORCE_LIMITED [1B] {35}
*MAT_140:	*MAT_VACUUM [0,8A] {0}
*MAT_141:	*MAT_RATE_SENSITIVE_POLYMER [0,3cd,8B] {6}
*MAT_142:	*MAT_TRANSVERSELY_ANISOTROPIC_CRUSHABLE_FOAM [0,3cd] {12}
*MAT_143:	*MAT_WOOD_{OPTION} [0,3cd,5] {37}
*MAT_144:	*MAT_PITZER_CRUSHABLEFOAM [0,3cd,8B] {7}
*MAT_145:	*MAT_SCHWER_MURRAY_CAP_MODEL [0,5] {50}
*MAT_146:	*MAT_1DOF_GENERALIZED_SPRING [1D] {1}
*MAT_147:	*MAT_FHWA_SOIL [0,3cd,5,8B] {15}
*MAT_147_N:	*MAT_FHWA_SOIL_NEBRASKA [0,3cd,5,8B] {15}
*MAT_148:	*MAT_GAS_MIXTURE [0,8A] {14}
*MAT_151:	*MAT_EMMI [0,3cd,5,8B] {23}
*MAT_153:	*MAT_DAMAGE_3 [0,1H,2,3abcd]
*MAT_154:	*MAT_DESHPANDE_FLECK_FOAM [0,3cd,8B] {10}
*MAT_155:	*MAT_PLASTICITY_COMPRESSION_TENSION_EOS [0,3cd,5,8B] {16}
*MAT_156:	*MAT_MUSCLE [1T] {0}

*MAT_157:	*MAT_ANISOTROPIC_ELASTIC_PLASTIC [2,3ab] {5}
*MAT_158:	*MAT_RATE_SENSITIVE_COMPOSITE_FABRIC [2,3ab] {54}
*MAT_159:	*MAT_CSCM_{OPTION} [0,3cd,5] {22}
*MAT_160:	* MAT_ALE_INCOMPRESSIBLE
*MAT_161:	*MAT_COMPOSITE_MSC [0] {34}
*MAT_162:	*MAT_COMPOSITE_DMG_MSC [0] {40}
*MAT_163:	*MAT_MODIFIED_CRUSHABLE_FOAM [0,3cd,8B] {10}
*MAT_164:	*MAT_BRAIN_LINEAR_VISCOELASTIC [0] {14}
*MAT_165:	*MAT_PLASTIC_NONLINEAR_KINEMATIC [0,2,3abcd,8B] {8}
*MAT_166:	*MAT_MOMENT_CURVATURE_BEAM [1B] {54}
*MAT_167:	*MAT_MCCORMICK [03cd,,8B] {8}
*MAT_168:	*MAT_POLYMER [0,3c,8B] {60}
*MAT_169:	*MAT_ARUP_ADHESIVE [0] {20}
*MAT_170:	*MAT_RESULTANT_ANISOTROPIC [2,3ab] {67}
*MAT_171:	*MAT_STEEL_CONCENTRIC_BRACE [1B] {33}
*MAT_172:	*MAT_CONCRETE_EC2 [1H,2,3ab] {35}
*MAT_173:	*MAT_MOHR_COULOMB [0,5] {31}
*MAT_174:	*MAT_RC_BEAM [1H] {26}
*MAT_175:	*MAT_VISCOELASTIC_THERMAL [0,2,3abcd,5,8B] {86}
*MAT_176:	*MAT_QUASILINEAR_VISCOELASTIC [0,2,3abcd,5,8B] {81}
*MAT_177:	*MAT_HILL_FOAM [0,3cd] {12}
*MAT_178:	*MAT_VISCOELASTIC_HILL_FOAM [0,3cd] {92}
*MAT_179:	*MAT_LOW_DENSITY_SYNTHETIC_FOAM_{OPTION} [0,3cd] {77}
*MAT_181:	*MAT_SIMPLIFIED_RUBBER/FOAM_{OPTION} [0,2,3cd] {39}
*MAT_183:	*MAT_SIMPLIFIED_RUBBER_WITH_DAMAGE [0,2,3cd] {44}
*MAT_184:	*MAT_COHESIVE_ELASTIC [7] {0}
*MAT_185:	*MAT_COHESIVE_TH [7] {0}
*MAT_186:	*MAT_COHESIVE_GENERAL [7] {6}
*MAT_187:	*MAT_SAMP-1 [0,2,3abcd] {38}
*MAT_188:	*MAT_THERMO_ELASTO_VISCOPLASTIC_CREEP [0,2,3abcd] {27}
*MAT_189:	*MAT_ANISOTROPIC_THERMOELASTIC [0,3c,8B] {21}
*MAT_190:	*MAT_FLD_3-PARAMETER_BARLAT [2,3ab] {36}
*MAT_191:	*MAT_SEISMIC_BEAM [1B] {36}
*MAT_192:	*MAT_SOIL_BRICK [0,3cd] {71}
*MAT_193:	*MAT_DRUCKER_PRAGER [0,3cd] {74}
*MAT_194:	*MAT_RC_SHEAR_WALL [2,3ab] {36}
*MAT_195:	*MAT_CONCRETE_BEAM [1H] {5}
*MAT_196:	*MAT_GENERAL_SPRING_DISCRETE_BEAM [1D] {25}
*MAT_197:	*MAT_SEISMIC_ISOLATOR [1D] {10}
*MAT_198:	*MAT_JOINTED_ROCK [0] {31}
*MAT_202:	*MAT_STEEL_EC3 [1H]
*MAT_214:	*MAT_DRY_FABRIC [9]
*MAT_219:	*MAT_CODAM2 [0,2,3abcd]
*MAT_220:	*MAT_RIGID_DISCRETE [0,2]
*MAT_221:	*MAT_ORTHOTROPIC_SIMPLIFIED_DAMAGE [0,3cd,5] {17}
*MAT_224:	*MAT_TABULATED_JOHNSON_COOK [0,2,3abcd,,5] {11}
*MAT_225:	*MAT_VISCOPLASTIC_MIXED_HARDENING [0,2,3abcd,5]
*MAT_226:	*MAT_KINEMATIC_HARDENING_BARLAT89 [2,3ab]
*MAT_230:	*MAT_PML_ELASTIC [0] {24}
*MAT_231:	*MAT_PML_ACOUSTIC [6] {35}
*MAT_232:	*MAT_BIOT_HYSTERETIC [0,2,3ab] {30}
*MAT_233:	*MAT_CAZACU_BARLAT [2,3ab]
*MAT_234:	*MAT_VISCOELASTIC_LOOSE_FABRIC [2,3a]
*MAT_235:	*MAT_MICROMECHANICS_DRY_FABRIC [2,3a]

*MAT

*MAT_236:	*MAT_SCC_ON_RCC [2,3ab]
*MAT_237:	*MAT_PML_HYSTERETIC [0] {54}
*MAT_238:	*MAT_PERT_PIECEWISE_LINEAR_PLASTICITY [0,1H,2,3,5,8A]
*MAT_240:	*MAT_COHESIVE_MIXED_MODE_ELASTOPLASTIC_RATE [0]
*MAT_241:	*MAT_JOHNSON_HOLMQUIST_JH1 [0,3cd,5]
*MAT_242:	*MAT_KINEMATIC_HARDENING_BARLAT2000 [2,3ab]
*MAT_243:	*MAT_HILL_90 [2,3ab]
*MAT_244:	*MAT_UHS_STEEL [0,2,3abcd,5]
*MAT_245:	*MAT_PML_{OPTION}TROPIC_ELASTIC [0] {30}
*MAT_246:	*MAT_PML_NULL [0] {27}
*MAT_251:	*MAT_TAILORED_PROPERTIES [2] {6}
*MAT_252:	*MAT_TOUGHENED_ADHESIVE_POLYMER [0,7] {10}
*MAT_255:	*MAT_PIECEWISE_LINEAR_PLASTIC_THERMAL [0,2,3abcd]
*MAT_256:	*MAT_AMORPHOUS_SOLIDS_FINITE_STRAIN [0]
*MAT_261:	*MAT_LAMINATED_FRACTURE_DAIMLER_PINHO [0,2,3abcd]
*MAT_262:	*MAT_LAMINATED_FRACTURE_DAIMLER_CAMANHO [0,2,3abcd]
*MAT_266:	*MAT_TISSUE_DISPERSED [0]
*MAT_267:	*MAT_EIGHT_CHAIN_RUBBER [0,5]
*MAT_269:	*MAT_BERGSTROM_BOYCE_RUBBER [0,5]
*MAT_270:	*MAT_CWM [0,5]
*MAT_271:	*MAT_POWDER [0,5]
*MAT_272:	*MAT_RHT [0,5]
*MAT_273:	*MAT_CONCRETE_DAMAGE_PLASTIC_MODEL [0]
*MAT_276:	*MAT_CHRONOLOGICAL_VISCOELASTIC [2,3abcd]

For the discrete (type 6) beam elements, which are used to model complicated dampers and multi-dimensional spring-damper combinations, the following material types are available:

*MAT_066:	*MAT_LINEAR_ELASTIC_DISCRETE_BEAM [1D]
*MAT_067:	*MAT_NONLINEAR_ELASTIC_DISCRETE_BEAM [1D]
*MAT_068:	*MAT_NONLINEAR_PLASTIC_DISCRETE_BEAM [1D]
*MAT_069:	*MAT_SID_DAMPER_DISCRETE_BEAM [1D]
*MAT_070:	*MAT_HYDRAULIC_GAS_DAMPER_DISCRETE_BEAM [1D]
*MAT_071:	*MAT_CABLE_DISCRETE_BEAM [1D]
*MAT_074:	*MAT_ELASTIC_SPRING_DISCRETE_BEAM [1D]
*MAT_093:	*MAT_ELASTIC_6DOF_SPRING_DISCRETE_BEAM [1D]
*MAT_094:	*MAT_INELASTIC_SPRING_DISCRETE_BEAM [1D]
*MAT_095:	*MAT_INELASTIC_6DOF_SPRING_DISCRETE_BEAM [1D]
*MAT_119:	*MAT_GENERAL_NONLINEAR_6DOF_DISCRETE_BEAM [1D]
*MAT_121:	*MAT_GENERAL_NONLINEAR_1DOF_DISCRETE_BEAM [1D]
*MAT_146:	*MAT_1DOF_GENERALIZED_SPRING [1D]
*MAT_196:	*MAT_GENERAL_SPRING_DISCRETE_BEAM [1D]
*MAT_197:	*MAT_SEISMIC_ISOLATOR [1D]
*MAT_208:	*MAT_BOLT_BEAM [1D]

For the discrete springs and dampers the following material types are available

*MAT_S01:	*MAT_SPRING_ELASTIC
*MAT_S02:	*MAT_DAMPER_VISCOUS
*MAT_S03:	*MAT_SPRING_ELASTOPLASTIC
*MAT_S04:	*MAT_SPRING_NONLINEAR_ELASTIC
*MAT_S05:	*MAT_DAMPER_NONLINEAR_VISCOUS
*MAT_S06:	*MAT_SPRING_GENERAL_NONLINEAR

*MAT_S07:	*MAT_SPRING_MAXWELL
*MAT_S08:	*MAT_SPRING_INELASTIC
*MAT_S13:	*MAT_SPRING_TRILINEAR_DEGRADING
*MAT_S14:	*MAT_SPRING_SQUAT_SHEARWALL
*MAT_S15:	*MAT_SPRING_MUSCLE

For ALE solids the following material types are available:

*MAT_ALE_01:	*MAT_ALE_VACUUM	(same as *MAT_140)
*MAT_ALE_02:	*MAT_ALE_GAS_MIXTURE	(same as *MAT_148)
*MAT_ALE_03:	*MAT_ALE_VISCOUS	(same as *MAT_009)
*MAT_ALE_04:	*MAT_ALE_MIXING_LENGTH	(same as *MAT_149)
*MAT_ALE_05:	*MAT_ALE_INCOMPRESSIBLE	(same as *MAT_160)
*MAT_ALE_06:	*MAT_ALE_HERSCHEL	

For the seatbelts one material is available.

*MAT_B01:	*MAT_SEATBELT
-----------	---------------

For thermal materials in a coupled structural/thermal or thermal only analysis, six materials are available. These materials are related to the structural material via the *PART card. Thermal materials are defined only for solid and shell elements.

*MAT_T01:	*MAT_THERMAL_ISOTROPIC
*MAT_T02:	*MAT_THERMAL_ORTHOTROPIC
*MAT_T03:	*MAT_THERMAL_ISOTROPIC_TD
*MAT_T04:	*MAT_THERMAL_ORTHOTROPIC_TD
*MAT_T05:	*MAT_THERMAL_DISCRETE_BEAM
*MAT_T07:	*MAT_THERMAL_CWM
*MAT_T08:	*MAT_THERMAL_ORTHOTROPIC_TD_LC
*MAT_T09:	*MAT_THERMAL_ISOTROPIC_PHASE_CHANGE
*MAT_T10:	*MAT_THERMAL_ISOTROPIC_TD_LC
*MAT_T11-T15:	*MAT_THERMAL_USER_DEFINED DEFINED

Remarks:

Curves and tables are sometimes defined for the purpose of defining material properties. An example would be a curve of effective stress vs. effective plastic strain defined using the command *DEFINE_CURVE. In general, the following can be said about curves and tables that are referenced by material models:

1. Curves are internally rediscritized using equal increments along the x-axis.
2. Curve data is interpolated between rediscritized data points within the defined range of the curve and extrapolated as needed beyond the defined range of the curve.
3. Extrapolation is not employed for table values (*DEFINE_TABLE...). See comments under *DEFINE_TABLE for further details.

MATERIAL MODEL REFERENCE TABLES

The tables provided on the following pages list the material models, some of their attributes, and the general classes of physical materials to which the numerical models might be applied.

If a material model, without consideration of *MAT_ADD_EROSION or *MAT_ADD_THERMAL_EXPANSION, includes any of the following attributes, a "Y" will appear in the respective column of the table:

SRATE	- Strain-rate effects
FAIL	- Failure criteria
EOS	- Equation-of-State required for 3D solids and 2D continuum elements
THERMAL	- Thermal effects
ANISO	- Anisotropic/orthotropic
DAM	- Damage effects
TENS	- Tension handled differently than compression in some manner

Potential applications of the material models, in terms of classes of physical materials, are abbreviated in the table as follows:

GN	- General
CM	- Composite
CR	- Ceramic
FL	- Fluid
FM	- Foam
GL	- Glass
HY	- Hydrodynamic material
MT	- Metal
PL	- Plastic
RB	- Rubber
SL	- Soil, concrete, or rock
AD	- Adhesive or Cohesive material
BIO	- Biological material
CIV	- Civil Engineering component

Material Number And Description		SRATE	FAIL	EOS	THERMAL	ANISO	DAM	TENS	APPS
1	Elastic								GN, FL
2	Orthotropic Elastic (Anisotropic-solids)					Y			CM, MT
3	Plastic Kinematic/Isotropic	Y	Y						CM, MT, PL
4	Elastic Plastic Thermal				Y				MT, PL
5	Soil and Foam							Y	FM, SL
6	Linear Viscoelastic	Y							RB
7	Blatz-Ko Rubber								RB
8	High Explosive Burn			Y					HY
9	Null Material	Y	Y	Y				Y	FL, HY
10	Elastic Plastic Hydro(dynamic)		Y	Y				Y	HY, MT
11	Steinberg: Temp. Dependent Elasto-plastic	Y	Y	Y	Y			Y	HY, MT
12	Isotropic Elastic Plastic								MT
13	Isotropic Elastic with Failure		Y					Y	MT
14	Soil and Foam with Failure		Y					Y	FM, SL
15	Johnson/Cook Plasticity Model	Y	Y	Y	Y		Y	Y	HY, MT
16	Pseudo Tensor Geological Model	Y	Y	Y			Y	Y	SL
17	Oriented Crack (Elastoplastic w/ Fracture)		Y	Y		Y		Y	HY, MT, PL, CR
18	Power Law Plasticity (Isotropic)	Y							MT, PL
19	Strain Rate Dependent Plasticity	Y	Y						MT, PL
20	Rigid								
21	Orthotropic Thermal (Elastic)				Y	Y			GN
22	Composite Damage		Y			Y		Y	CM
23	Temperature Dependent Orthotropic				Y	Y			CM
24	Piecewise Linear Plasticity (Isotropic)	Y	Y						MT, PL
25	Inviscid Two Invariant Geologic Cap		Y					Y	SL
26	Honeycomb	Y	Y			Y		Y	CM, FM, SL
27	Mooney-Rivlin Rubber							Y	RB
28	Resultant Plasticity								MT
29	Force Limited Resultant Formulation							Y	

Material Number And Description		SRATE	FAIL	EOS	THERMAL	ANISO	DAM	TENS	APPS
30	Shape Memory								MT
31	Frazer-Nash Rubber							Y	RB
32	Laminated Glass (Composite)		Y						CM, GL
33	Barlat Anisotropic Plasticity (YLD96)	Y				Y			CR, MT
34	Fabric					Y		Y	fabric
35	Plastic-Green Naghdi Rate	Y							MT
36	Three-Parameter Barlat Plasticity	Y			Y	Y			MT
37	Transversely Anisotropic Elastic Plastic					Y			MT
38	Blatz-Ko Foam								FM, PL
39	FLD Transversely Anisotropic					Y			MT
40	Nonlinear Orthotropic		Y		Y	Y		Y	CM
41	-50 User Defined Materials	Y	Y	Y	Y	Y	Y	Y	GN
51	Bamman (Temp/Rate Dependent Plasticity)	Y			Y				GN
52	Bamman Damage	Y	Y		Y		Y		MT
53	Closed cell foam (Low density polyurethane)								FM
54	Composite Damage with Chang Failure		Y			Y	Y	Y	CM
55	Composite Damage with Tsai-Wu Failure		Y			Y	Y	Y	CM
57	Low Density Urethane Foam	Y	Y					Y	FM
58	Laminated Composite Fabric		Y			Y	Y	Y	CM, fabric
59	Composite Failure (Plasticity Based)		Y			Y		Y	CM, CR
60	Elastic with Viscosity (Viscous Glass)	Y			Y				GL
61	Kelvin-Maxwell Viscoelastic	Y							FM
62	Viscous Foam (Crash dummy Foam)	Y							FM
63	Isotropic Crushable Foam							Y	FM
64	Rate Sensitive Powerlaw Plasticity	Y							MT
65	Zerilli-Armstrong (Rate/Temp Plasticity)	Y		Y	Y			Y	MT
66	Linear Elastic Discrete Beam	Y				Y			
67	Nonlinear Elastic Discrete Beam	Y				Y		Y	
68	Nonlinear Plastic Discrete Beam	Y	Y			Y			

Material Number And Description		SRATE	FAIL	EOS	THERMAL	ANISO	DAM	TENS	APPS
69	SID Damper Discrete Beam	Y							
70	Hydraulic Gas Damper Discrete Beam	Y							
71	Cable Discrete Beam (Elastic)							Y	cable
72	Concrete Damage (incl. Release III)	Y	Y	Y			Y	Y	SL
73	Low Density Viscous Foam	Y	Y					Y	FM
74	Elastic Spring Discrete Beam	Y	Y					Y	
75	Bilkhu/Dubois Foam							Y	FM
76	General Viscoelastic (Maxwell Model)	Y			Y			Y	RB
77	Hyperelastic and Ogden Rubber	Y						Y	RB
78	Soil Concrete		Y				Y	Y	SL
79	Hysteretic Soil (Elasto-Perfectly Plastic)		Y					Y	SL
80	Ramberg-Osgood								SL
81	Plasticity with Damage	Y	Y				Y		MT, PL
82	Plasticity with Damage Ortho	Y	Y			Y	Y		
83	Fu Chang Foam	Y	Y				Y	Y	FM
84	Winfrith Concrete (w/ rate effects)	Y						Y	FM, SL
85	Winfrith Concrete							Y	SL
86	Orthotropic Viscoelastic	Y				Y			RB
87	Cellular Rubber	Y						Y	RB
88	MTS	Y		Y	Y				MT
89	Plasticity Polymer	Y						Y	PL
90	Acoustic							Y	FL
91	Soft Tissue	Y	Y			Y		Y	BIO
92	Soft Tissue (viscous)								
93	Elastic 6DOF Spring Discrete Beam	Y	Y			Y		Y	
94	Inelastic Spring Discrete Beam	Y	Y					Y	
95	Inelastic 6DOF Spring Discrete Beam	Y	Y			Y		Y	
96	Brittle Damage	Y	Y			Y	Y	Y	SL
97	General Joint Discrete Beam								
98	Simplified Johnson Cook	Y	Y						MT
99	Simpl. Johnson Cook Orthotropic Damage	Y	Y			Y	Y		MT

Material Number And Description		SRATE	FAIL	EOS	THERMAL	ANISO	DAM	TENS	APPS
100	Spotweld	Y	Y				Y	Y	MT
101	GE Plastic Strain Rate	Y	Y					Y	PL
102	Inv. Hyperbolic Sin	Y			Y				MT, PL
103	Anisotropic Viscoplastic	Y	Y			Y			MT
103P	Anisotropic Plastic					Y			MT
104	Damage 1	Y	Y			Y	Y		MT
105	Damage 2	Y	Y				Y		MT
106	Elastic Viscoplastic Thermal	Y			Y				PL
107	Modified Johnson Cook	Y	Y		Y		Y		MT
108	Ortho Elastic Plastic					Y			
110	Johnson Holmquist Ceramics	Y	Y				Y	Y	CR, GL
111	Johnson Holmquist Concrete	Y	Y				Y	Y	SL
112	Finite Elastic Strain Plasticity	Y							PL
113	Transformation Induced Plasticity (TRIP)				Y				MT
114	Layered Linear Plasticity	Y	Y						MT, PL, CM
115	Unified Creep								
116	Composite Layup					Y			CM
117	Composite Matrix					Y			CM
118	Composite Direct					Y			CM
119	General Nonlinear 6DOF Discrete Beam	Y	Y			Y		Y	
120	Gurson	Y	Y				Y	Y	MT
121	General Nonlinear 1DOF Discrete Beam	Y	Y					Y	
122	Hill 3RC					Y			MT
123	Modified Piecewise Linear Plasticity	Y	Y						MT, PL
124	Plasticity Compression Tension	Y	Y					Y	MT, PL
125	Kinematic Hardening Transversely Aniso.					Y			MT
126	Modified Honeycomb	Y	Y			Y	Y	Y	CM, FM, SL
127	Arruda Boyce Rubber	Y							RB
128	Heart Tissue					Y		Y	BIO
129	Lung Tissue	Y						Y	BIO

Material Number And Description		SRATE	FAIL	EOS	THERMAL	ANISO	DAM	TENS	APPS
130	Special Orthotropic					Y			
131	Isotropic Smeared Crack		Y				Y	Y	MT, CM
132	Orthotropic Smeared Crack		Y			Y	Y		MT, CM
133	Barlat YLD2000	Y			Y	Y			MT
134	Viscoelastic Fabric								
135	Weak and Strong Texture Model	Y	Y			Y			MT
136	Corus Vegter					Y			MT
138	Cohesive Mixed Mode		Y			Y	Y	Y	AD
139	Modified Force Limited						Y	Y	
140	Vacuum								
141	Rate Sensitve Polymer	Y							PL
142	Transversely Anisotropic Crushable Foam					Y		Y	FM
143	Wood	Y	Y			Y	Y	Y	(wood)
144	Pitzer Crushable Foam	Y						Y	FM
145	Schwer Murray Cap Model	Y	Y				Y	Y	SL
146	1DOF Generalized Spring	Y							
147	FWHA Soil	Y					Y	Y	SL
147N	FHWA Soil Nebraska	Y					Y	Y	SL
148	Gas Mixture				Y				FL
151	Evolving Microstructural Model of Inelast.	Y	Y		Y	Y	Y		MT
153	Damage 3	Y	Y				Y		MT, PL
154	Deshpande Fleck Foam		Y						FM
155	Plasticity Compression Tension EOS	Y	Y	Y				Y	(ice)
156	Muscle	Y						Y	BIO
157	Anisotropic Elastic Plastic					Y			MT, CM
158	Rate-Sensitive Composite Fabric	Y	Y			Y	Y	Y	CM
159	CSCM	Y	Y				Y	Y	SL
160	ALE incompressible								
161	,162 Composite MSC	Y	Y			Y	Y	Y	CM
163	Modified Crushable Foam	Y						Y	FM
164	Brain Linear Viscoelastic	Y							BIO

Material Number And Description		SRATE	FAIL	EOS	THERMAL	ANISO	DAM	TENS	APPS
165	Plastic Nonlinear Kinematic		Y						MT
166	Moment Curvature Beam	Y	Y					Y	CIV
167	McCormick	Y							MT
168	Polymer				Y			Y	PL
169	Arup Adhesive	Y	Y			Y		Y	AD
170	Resultant Anisotropic					Y			PL
171	Steel Concentric Brace						Y	Y	CIV
172	Concrete EC2		Y		Y			Y	SL, MT
173	Mohr Coulomb					Y		Y	SL
174	RC Beam						Y	Y	SL
175	Viscoelastic Thermal	Y			Y			Y	RB
176	Quasilinear Viscoelastic	Y	Y				Y	Y	BIO
177	Hill Foam							Y	FM
178	Viscoelastic Hill Foam (Ortho)	Y						Y	FM
179	Low Density Synthetic Foam	Y	Y			Y	Y	Y	FM
181	Simplified Rubber/Foam	Y	Y				Y	Y	RB, FM
183	Simplified Rubber with Damage	Y					Y	Y	RB
184	Cohesive Elastic		Y					Y	AD
185	Cohesive TH		Y			Y	Y	Y	AD
186	Cohesive General		Y			Y	Y	Y	AD
187	Semi-Analytical Model for Polymers – 1	Y	Y				Y		PL
188	Thermo Elasto Viscoelastic Creep	Y			Y				MT
189	Anisotropic Thermoelastic				Y	Y			
190	Flow limit diagram 3-Parameter Barlat		Y			Y		Y	MT
191	Seismic Beam							Y	CIV
192	Soil Brick					Y			SL
193	Drucker Prager							Y	SL
194	RC Shear Wall		Y				Y	Y	CIV
195	Concrete Beam	Y	Y				Y	Y	CIV
196	General Spring Discrete Beam	Y						Y	
197	Seismic Isolator	Y	Y			Y		Y	CIV

Material Number And Description		SRATE	FAIL	EOS	THERMAL	ANISO	DAM	TENS	APPS
198	Jointed Rock		Y			Y		Y	SL
202	Steel EC3								CIV
214	Dry Fabric	Y	Y			Y	Y	Y	
208	Bolt Beam								
219	CODAM2		Y			Y	Y	Y	CM
220	Rigid Discrete								
221	Orthotropic Simplified Damage		Y			Y	Y	Y	CM
224	Tabulated Johnson Cook	Y	Y	Y	Y		Y	Y	HY, MT, PL
225	Viscoplastic Mixed Hardening	Y	Y						MT, PL
226	Kinematic hardening Barlat 89					Y			MT
230	Elastic Perfectly Matched Layer (PML)	Y							SL
231	Acoustic PML								FL
232	Biot Linear Hysteretic Material	Y							SL
233	Cazacu Barlat					Y		Y	MT
234	Viscoelastic Loose Fabric	Y	Y			Y		Y	Fabric
235	Micromechanic Dry Fabric					Y		Y	Fabric
236	Ceramic Matrix		Y			Y		Y	CM, CR
237	Biot Hysteretic PML	Y							SL
238	Piecewise linear plasticity (PERT)	Y	Y						MT, PL
240	Cohesive mixed mode	Y	Y			Y	Y	Y	AD
241	Johnson Holmquist JH1	Y	Y				Y	Y	CR, GL
242	Kinematic hardening Barlat 2000					Y			MT
243	Hill 90	Y			Y	Y			MT
244	UHS Steel	Y			Y				MT
245	Orthotropic/anisotropic PML	Y							SL
246	Null material PML			Y					FL
251	Tailored Properties	Y	Y						MT, PL
252	Toughened Adhesive Polymer	Y	Y			Y	Y	Y	AD
255	Piecewise linear plastic thermal	Y	Y		Y			Y	MT
256	Amorphous solid (finite strain)	Y						Y	GL
261	Laminated Fracture Daimler Pinho		Y			Y	Y	Y	CM

Material Number And Description		SRATE	FAIL	EOS	THERMAL	ANISO	DAM	TENS	APPS
262	Laminated Fracture Daimler Camanho		Y			Y	Y	Y	CM
266	Dispersed tissue					Y			BIO
267	Eight chain rubber	Y				Y			RB, PL
269	Bergström Boyce rubber	Y							RB
270	Welding material				Y				MT,PL
271	Powder compaction							Y	CR,SL
272	RHT concrete model	Y	Y				Y	Y	SL,CIV
273	Concrete damage plastic	Y	Y				Y	Y	SL
276	Chronological viscoelastic	Y			Y				RB
A01	ALE Vacuum								FL
A02	ALE Gas Mixture				Y				FL
A03	ALE Viscous			Y				Y	FL
A04	ALE Mixing Length								FL
A05	ALE Incompressible								FL
A06	ALE Herschel			Y				Y	FL
S1	Spring Elastic (Linear)								
S2	Damper Viscous (Linear)	Y							
S3	Spring Elastoplastic (Isotropic)								
S4	Spring Nonlinear Elastic	Y						Y	
S5	Damper Nonlinear Viscous	Y						Y	
S6	Spring General Nonlinear							Y	
S7	Spring Maxwell (3-Parameter Viscoelastic)	Y							
S8	Spring Inelastic (Tension or Compression)							Y	
S13	Spring Trilinear Degrading		Y				Y		CIV
S14	Spring Squat Shearwall						Y		CIV
S15	Spring Muscle	Y						Y	BIO
B1	Seatbelt							Y	
T01	Thermal Isotropic				Y				Heat transfer
T02	Thermal Orthotropic				Y	Y			Heat transfer
T03	Thermal Isotropic (Temp Dependent)				Y				Heat transfer

Material Number And Description		SRATE	FAIL	EOS	THERMAL	ANISO	DAM	TENS	APPS
T04	Thermal Orthotropic (Temp Depend-ent)				Y	Y			Heat transfer
T05	Thermal Discrete Beam				Y				Heat transfer
T07	Thermal CWM (Welding)				Y				Heat transfer
T08	Thermal Orthotropic(Temp dep-load curve)				Y	Y			Heat transfer
T09	Thermal Isotropic (Phase Change)				Y				Heat transfer
T10	Thermal Isotropic (Temp dep-load curve)				Y				Heat transfer
T11	Thermal User Defined				Y				Heat transfer

*ALPHABETIZED MATERIALS LIST

ALPHABETIZED MATERIALS LIST

Material Keyword	Number
*EOS	
*EOS_GASKET	
*EOS_GRUNEISEN	
*EOS_IDEAL_GAS	
*EOS_IGNITION_AND_GROWTH_OF_REACTION_IN_HE	
*EOS_JWL	
*EOS_JWLB	
*EOS_LINEAR_POLYNOMIAL	
*EOS_LINEAR_POLYNOMIAL_WITH_ENERGY_LEAK	
*EOS_MIE_GRUNEISEN	
*EOS_PROPELLENT_DEFLAGRATION	
*EOS_RADIO_OF_POLYNOMIALS	
*EOS_SACK_TUESDAY	
*EOS_TABULATED	
*EOS_TABULATED_COMPACTION	
*EOS_TENSOR_PORE_COLLAPSE	
*EOS_USER_DEFINED	
*MAT_{OPTION}TROPIC_ELASTIC	*MAT_002
*MAT_1DOF_GENERALIZED_SPRING	*MAT_146
*MAT_3-PARAMETER_BARLAT	*MAT_036
*MAT_ACOUSTIC	*MAT_090
*MAT_ADD_AIRBAG_PEROSITY_LEAKAGE	
*MAT_ADD_COHESIVE	
*MAT_ADD_EROSION	
*MAT_ADD_PERMEABILITY	
*MAT_ADD_PORE_AIR	
*MAT_ADD_THERMAL_EXPANSION	

ALPHABETIZED MATERIALS LIST

Material Keyword	Number
*MAT_ALE_GAS_MIXTURE	*MAT_ALE_02
*MAT_ALE_HERSHEL	*MAT_ALE_06
*MAT_ALE_INCOMPRESSIBLE	*MAT_160
*MAT_ALE_MIXING_LENGTH	*MAT_ALE_04
*MAT_ALE_VACUUM	*MAT_ALE_01
*MAT_ALE_VISCOIS	*MAT_ALE_03
*MAT_AMORPHOUS_SOLIDS_FINITE_STRAIN	*MAT_256
*MAT_ANISOTROPIC_ELASTIC_PLASTIC	*MAT_157
*MAT_ANISOTROPIC_PLASTIC	*MAT_103_P
*MAT_ANISOTROPIC_THERMOELASTIC	*MAT_189
*MAT_ANISOTROPIC_VISCOPLASTIC	*MAT_103
*MAT_ARRUDA_BOYCE_RUBBER	*MAT_127
*MAT_ARUP_ADHESIVE	*MAT_169
*MAT_BAMMAN	*MAT_051
*MAT_BAMMAN_DAMAGE	*MAT_052
*MAT_BARLAT_ANISOTROPIC_PLASTICITY	*MAT_033
*MAT_BARLAT_YLD2000	*MAT_133
*MAT_BARLAT_YLD96	*MAT_033_96
*MAT_BERGSTROM_BOYCE_RUBBER	*MAT_269
*MAT_BILKHU/DUBOIS_FOAM	*MAT_075
*MAT_BIOT_HYSTERETIC	*MAT_232
*MAT_BLATZ-KO_FOAM	*MAT_038
*MAT_BLATZ-KO_RUBBER	*MAT_007
*MAT_BOLT_BEAM	*MAT_208
*MAT_BRAIN_LINEAR_VISCOELASTIC	*MAT_164
*MAT_BRITTLE_DAMAGE	*MAT_096
*MAT_CABLE_DISCRETE_BEAM	*MAT_071
*MAT_CAZACU_BARLAT	*MAT_233
*MAT_CELLULAR_RUBBER	*MAT_087
*MAT_CHRONOLOGICAL_VISCOELASTIC	*MAT_276

*ALPHABETIZED MATERIALS LIST

Material Keyword	Number
*MAT_CLOSED_CELL_FOAM	*MAT_053
*MAT_CODAM2	*MAT_219
*MAT_COHESIVE_ELASTIC	*MAT_184
*MAT_COHESIVE_GENERAL	*MAT_186
*MAT_COHESIVE_MIXED_MODE	*MAT_138
*MAT_COHESIVE_MIXED_MODE_ELASTOPLASTIC_RATE	*MAT_240
*MAT_COHESIVE_TH	*MAT_185
*MAT_COMPOSITE_DAMAGE	*MAT_022
*MAT_COMPOSITE_DIRECT	*MAT_118
*MAT_COMPOSITE_DMG_MSC	*MAT_162
*MAT_COMPOSITE_FAILURE_{OPTION}_MODEL	*MAT_059
*MAT_COMPOSITE_LAYUP	*MAT_116
*MAT_COMPOSITE_MATRIX	*MAT_117
*MAT_COMPOSITE_MSC	*MAT_161
*MAT_CONCRETE_BEAM	*MAT_195
*MAT_CONCRETE_DAMAGE	*MAT_072
*MAT_CONCRETE_DAMAGE_PLASTIC_MODEL	*MAT_273
*MAT_CONCRETE_DAMAGE_REL3	*MAT_072R3
*MAT_CONCRETE_EC2	*MAT_172
*MAT_CORUS_VEGTER	*MAT_136
*MAT_CRUSHABLE_FOAM	*MAT_063
*MAT_CSCM_{OPTION}	*MAT_159
*MAT_CWM	*MAT_270
*MAT_DAMAGE_1	*MAT_104
*MAT_DAMAGE_2	*MAT_105
*MAT_DAMAGE_3	*MAT_153
*MAT_DAMPER_NONLINEAR_VISCOUS	*MAT_S05
*MAT_DAMPER_VISCOUS	*MAT_S02
*MAT_DESHPANDE_FLECK_FOAM	*MAT_154
*MAT_DRUCKER_PRAGER	*MAT_193

ALPHABETIZED MATERIALS LIST

Material Keyword	Number
*MAT_DRY_FABRIC	*MAT_214
*MAT_EIGHT_CHAIN_RUBBER	*MAT_267
*MAT_ELASTIC	*MAT_001
*MAT_ELASTIC_6DOF_SPRING_DISCRETE_BEAM	*MAT_093
*MAT_ELASTIC_FLUID	*MAT_001_FLUID
*MAT_ELASTIC_PLASTIC_HYDRO_{OPTION}	*MAT_010
*MAT_ELASTIC_PLASTIC_THERMAL	*MAT_004
*MAT_ELASTIC_SPRING_DISCRETE_BEAM	*MAT_074
*MAT_ELASTIC_VISCOPLASTIC_THERMAL	*MAT_106
*MAT_ELASTIC_WITH_VISCOSITY	*MAT_060
*MAT_ELASTIC_WITH_VISCOSITY_CURVE	*MAT_060C
*MAT_EMMI	*MAT_151
*MAT_ENHANCED_COMPOSITE_DAMAGE	*MAT_054-055
*MAT_FABRIC	*MAT_034
*MAT_FHWA_SOIL	*MAT_147
*MAT_FHWA_SOIL_NEBRASKA	*MAT_147_N
*MAT_FINITE_ELASTIC_STRAIN_PLASTICITY	*MAT_112
*MAT_FLD_3-PARAMETER_BARLAT	*MAT_190
*MAT_FLD_TRANSVERSELY_ANISOTROPIC	*MAT_039
*MAT_FORCE_LIMITED	*MAT_029
*MAT_FRAZER_NASH_RUBBER_MODEL	*MAT_031
*MAT_FU_CHANG_FOAM	*MAT_083
*MAT_GAS_MIXTURE	*MAT_148
*MAT_GENERAL_JOINT_DISCRETE_BEAM	*MAT_097
*MAT_GENERAL_NONLINEAR_1DOF_DISCRETE_BEAM	*MAT_121
*MAT_GENERAL_NONLINEAR_6DOF_DISCRETE_BEAM	*MAT_119
*MAT_GENERAL_SPRING_DISCRETE_BEAM	*MAT_196
*MAT_GENERAL_VISCOELASTIC	*MAT_076
*MAT_GEOLOGIC_CAP_MODEL	*MAT_025
*MAT_GEPLASTIC_SRATE_2000a	*MAT_101

*ALPHABETIZED MATERIALS LIST

Material Keyword	Number
*MAT_GURSON	*MAT_120
*MAT_GURSON_JC	*MAT_120_JC
*MAT_GURSON_RCDC	*MAT_120_RCDC
*MAT_HEART_TISSUE	*MAT_128
*MAT_HIGH_EXPLOSIVE_BURN	*MAT_008
*MAT_HILL_3R	*MAT_122
*MAT_HILL_90	*MAT_243
*MAT_HILL_FOAM	*MAT_177
*MAT_HONEYCOMB	*MAT_026
*MAT_HYDRAULIC_GAS_DAMPER_DISCRETE_BEAM	*MAT_070
*MAT_HYPERELASTIC_RUBBER	*MAT_077_H
*MAT_HYSTERETIC_SOIL	*MAT_079
*MAT_INELASTC_6DOF_SPRING_DISCRETE_BEAM	*MAT_095
*MAT_INELASTIC_6DOF_SPRING_DISCRETE_BEAM	*MAT_095
*MAT_INELASTIC_SPRING_DISCRETE_BEAM	*MAT_094
*MAT_INV_HYPERBOLIC_SIN	*MAT_102
*MAT_ISOTROPIC_ELASTIC_FAILURE	*MAT_013
*MAT_ISOTROPIC_ELASTIC_PLASTIC	*MAT_012
*MAT_ISOTROPIC_SMEARED_CRACK	*MAT_131
*MAT_JOHNSON_COOK	*MAT_015
*MAT_JOHNSON_HOLMQUIST_CERAMICS	*MAT_110
*MAT_JOHNSON_HOLMQUIST_CONCRETE	*MAT_111
*MAT_JOHNSON_HOLMQUIST_JH1	*MAT_241
*MAT_JOINTED_ROCK	*MAT_198
*MAT_KELVIN-MAXWELL_VISCOELASTIC	*MAT_061
*MAT_KINEMATIC_HARDENING_BARLAT2000	*MAT_242
*MAT_KINEMATIC_HARDENING_BARLAT89	*MAT_226
*MAT_KINEMATIC_HARDENING_TRANSVERSELY_ANISOTROPIC	*MAT_125
*MAT_LAMINATED_COMPOSITE_FABRIC	*MAT_058
*MAT_LAMINATED_FRACTURE_DAIMLER_CAMANHO	*MAT_262

ALPHABETIZED MATERIALS LIST

Material Keyword	Number
*MAT_LAMINATED_FRACTURE_DAIMLER_PINHO	*MAT_261
*MAT_LAMINATED_GLASS	*MAT_032
*MAT_LAYERED_LINEAR_PLASTICITY	*MAT_114
*MAT_LINEAR_ELASTIC_DISCRETE_BEAM	*MAT_066
*MAT_LOW_DENSITY_FOAM	*MAT_057
*MAT_LOW_DENSITY_SYNTHETIC_FOAM_{OPTION}	*MAT_179
*MAT_LOW_DENSITY_VISCOUS_FOAM	*MAT_073
*MAT_LUNG_TISSUE	*MAT_129
*MAT_MCCORMICK	*MAT_167
*MAT_MICROMECHANICS_DRY_FABRIC	*MAT_235
*MAT_MODIFIED_CRUSHABLE_FOAM	*MAT_163
*MAT_MODIFIED_FORCE_LIMITED	*MAT_139
*MAT_MODIFIED_HONEYCOMB	*MAT_126
*MAT_MODIFIED_JOHNSON_COOK	*MAT_107
*MAT_MODIFIED_PIECEWISE_LINEAR_PLASTICITY	*MAT_123
*MAT_MODIFIED_ZERILLI_ARMSTRONG	*MAT_065
*MAT_MOHR_COULOMB	*MAT_173
*MAT_MOMENT_CURVATURE_BEAM	*MAT_166
*MAT_MOONEY-RIVLIN_RUBBER	*MAT_027
*MAT_MTS	*MAT_088
*MAT_MUSCLE	*MAT_156
*MAT_NONLINEAR_ELASTIC_DISCRETE_BEAM	*MAT_067
*MAT_NONLINEAR_ORTHOTROPIC	*MAT_040
*MAT_NONLINEAR_PLASTIC_DISCRETE_BEAM	*MAT_068
*MAT_NULL	*MAT_009
*MAT_OGDEN_RUBBER	*MAT_077_O
*MAT_OPTION_TROPIC_ELASTIC	*MAT_002
*MAT_ORIENTED_CRACK	*MAT_017
*MAT_ORTHO_ELASTIC_PLASTIC	*MAT_108
*MAT_ORTHOTROPIC_SIMPLIFIED_DAMAGE	*MAT_221

*ALPHABETIZED MATERIALS LIST

Material Keyword	Number
*MAT_ORTHOTROPIC_SMEARED_CRACK	*MAT_132
*MAT_ORTHOTROPIC_THERMAL	*MAT_021
*MAT_ORTHOTROPIC_VISCOELASTIC	*MAT_086
*MAT_PERT_PIECEWISE_LINEAR_PLASTICITY	*MAT_238
*MAT_PIECEWISE_LINEAR_PLASTIC_THERMAL	*MAT_255
*MAT_PIECEWISE_LINEAR_PLASTICITY	*MAT_024
*MAT_PITZER_CRUSHABLEFOAM	*MAT_144
*MAT_PLASTIC_GREEN-NAGHDI_RATE	*MAT_035
*MAT_PLASTIC_KINEMATIC	*MAT_003
*MAT_PLASTIC_NONLINEAR_KINEMATIC	*MAT_165
*MAT_PLASTICITY_COMPRESSION_TENSION	*MAT_124
*MAT_PLASTICITY_COMPRESSION_TENSION_EOS	*MAT_155
*MAT_PLASTICITY_POLYMER	*MAT_089
*MAT_PLASTICITY_WITH_DAMAGE	*MAT_081
*MAT_PLASTICITY_WITH_DAMAGE_ORTHO(_RCDC)	*MAT_082(_RCDC)
*MAT_PML_{OPTION}TROPIC_ELASTIC	*MAT_245
*MAT_PML_ACOUSTIC	*MAT_231
*MAT_PML_ELASTIC	*MAT_230
*MAT_PML_ELASTIC_FLUID	*MAT_230
*MAT_PML_HYSTERETIC	*MAT_237
*MAT_PML_NULL	*MAT_246
*MAT_POLYMER	*MAT_168
*MAT_POWDER	*MAT_271
*MAT_POWER_LAW_PLASTICITY	*MAT_018
*MAT_PSEUDO_TENSOR	*MAT_016
*MAT_QUASILINEAR_VISCOELASTIC	*MAT_176
*MAT_RAMBERG-OSGOOD	*MAT_080
*MAT_RATE_SENSITIVE_COMPOSITE_FABRIC	*MAT_158
*MAT_RATE_SENSITIVE_POLYMER	*MAT_141
*MAT_RATE_SENSITIVE_POWERLAW_PLASTICITY	*MAT_064

ALPHABETIZED MATERIALS LIST

Material Keyword	Number
*MAT_RC_BEAM	*MAT_174
*MAT_RC_SHEAR_WALL	*MAT_194
*MAT_RESULTANT_ANISOTROPIC	*MAT_170
*MAT_RESULTANT_PLASTICITY	*MAT_028
*MAT_RHT	*MAT_272
*MAT_RIGID	*MAT_020
*MAT_RIGID_DISCRETE	*MAT_220
*MAT_SAMP-1	*MAT_187
*MAT_SCC_ON_RCC	*MAT_236
*MAT_SCHWER_MURRAY_CAP_MODEL	*MAT_145
*MAT_SEATBELT	*MAT_B01
*MAT_SEISMIC_BEAM	*MAT_191
*MAT_SEISMIC_ISOLATOR	*MAT_197
*MAT_SHAPE_MEMORY	*MAT_030
*MAT_SID_DAMPER_DISCRETE_BEAM	*MAT_069
*MAT_SIMPLIFIED_JOHNSON_COOK	*MAT_098
*MAT_SIMPLIFIED_JOHNSON_COOK_ORTHOTROPIC_DAMAGE	*MAT_099
*MAT_SIMPLIFIED_RUBBER/FOAM_{OPTION}	*MAT_181
*MAT_SIMPLIFIED_RUBBER_WITH_DAMAGE	*MAT_183
*MAT_SOFT_TISSUE	*MAT_091
*MAT_SOFT_TISSUE_VISCO	*MAT_092
*MAT_SOIL_AND_FOAM	*MAT_005
*MAT_SOIL_AND_FOAM_FAILURE	*MAT_014
*MAT_SOIL_BRICK	*MAT_192
*MAT_SOIL_CONCRETE	*MAT_078
*MAT_SPECIAL_ORTHOTROPIC	*MAT_130
*MAT_SPOTWELD_{OPTION}	*MAT_100
*MAT_SPOTWELD_DAIMLERCHRYSLER	*MAT_100_DA
*MAT_SPRING_ELASTIC	*MAT_S01
*MAT_SPRING_ELASTOPLASTIC	*MAT_S03

*ALPHABETIZED MATERIALS LIST

Material Keyword	Number
*MAT_SPRING_GENERAL_NONLINEAR	*MAT_S06
*MAT_SPRING_INELASTIC	*MAT_S08
*MAT_SPRING_MAXWELL	*MAT_S07
*MAT_SPRING_MUSCLE	*MAT_S15
*MAT_SPRING_NONLINEAR_PLASTIC	*MAT_S04
*MAT_SPRING_SQUAT_SHEARWALL	*MAT_S14
*MAT_SPRING_TRILINEAR_DEGRADING	*MAT_S13
*MAT_STEEL_CONCENTRIC_BRACE	*MAT_171
*MAT_STEEL_EC3	*MAT_202
*MAT_STEINBERG	*MAT_011
*MAT_STEINBERG_LUND	*MAT_011_LUND
*MAT_STRAIN_RATE_DEPENDENT_PLASTICITY	*MAT_019
*MAT_TABULATED_JOHNSON_COOK }	*MAT_224
*MAT_TAILORED_PROPERTIES	*MAT_251
*MAT_TEMPERATURE_DEPENDENT_ORTHOTROPIC	*MAT_023
*MAT_THERMAL_CWM	*MAT_T07
*MAT_THERMAL_DISCRETE_BEAM	*MAT_T05
*MAT_THERMAL_ISOTROPIC	*MAT_T01
*MAT_THERMAL_ISOTROPIC_PHASE_CHANGE	*MAT_T09
*MAT_THERMAL_ISOTROPIC_TD	*MAT_T03
*MAT_THERMAL_ISOTROPIC_TD_LC	*MAT_T10
*MAT_THERMAL_OPTION	*MAT_T00
*MAT_THERMAL_ORTHOTROPIC	*MAT_T02
*MAT_THERMAL_ORTHOTROPIC_TD	*MAT_T04
*MAT_THERMAL_ORTHOTROPIC_TD_LC	*MAT_T08
*MAT_THERMAL_USER_DEFINED	*MAT_T11
*MAT_THERMO_ELASTO_VISCOPLASTIC_CREEP	*MAT_188
*MAT_TISSUE_DISPERSED	*MAT_266
*MAT_TOUGHENED_ADHESIVE_POLYMER	*MAT_252
*MAT_TRANSVERSELY_ANISOTROPIC_CRUSHABLE_FOAM	*MAT_142

ALPHABETIZED MATERIALS LIST

Material Keyword	Number
*MAT_TRANSVERSELY_ANISOTROPIC_ELASTIC_PLASTIC	*MAT_037
*MAT_TRANSVERSELY_ISOTROPIC_CRUSHABLE_FOAM	*MAT_142
*MAT_TRIP	*MAT_113
*MAT_UHS_STEEL	*MAT_244
*MAT_UNIFIED_CREEP	*MAT_115
*MAT_USER_DEFINED_MATERIAL_MODELS	*MAT_041-050
*MAT_VACUUM	*MAT_140
*MAT_VISCOELASTIC	*MAT_006
*MAT_VISCOELASTIC_FABRIC	*MAT_134
*MAT_VISCOELASTIC_HILL_FOAM	*MAT_178
*MAT_VISCOELASTIC_LOOSE_FABRIC	*MAT_234
*MAT_VISCOELASTIC_THERMAL	*MAT_175
*MAT_VISCOPLASTIC_MIXED_HARDENING	*MAT_225
*MAT_VISCOUS_FOAM	*MAT_062
*MAT_WINFIRTH_CONCRETE_REINFORCEMENT	*MAT_084
*MAT_WINFRITH_CONCRETE	*MAT_084-085
*MAT_WOOD_{OPTION}	*MAT_143
*MAT_WTM_STM	*MAT_135
*MAT_WTM_STM_PLC	*MAT_135_PLC

***MAT_ADD_AIRBAG_POROSITY_LEAKAGE**

This command allows users to model porosity leakage through non-fabric material when such material is used as part of control volume, airbag. It applies to both *AIRBAG_HYBRID and *AIRBAG_WANG_NEFSKE.

Card 1	1	2	3	4	5	6	7	8
Variable	MID	FLC/X2	FAC/X3	ELA	FVOPT	X0	X1	
Type	I	F	F	F	F	F	F	
Default	none	none	1.0	none	none	none	none	

VARIABLE**DESCRIPTION**

MID

Material ID for which the porosity leakage property applies

FLC/X2

If $X0 \neq 0$ and $X0 \neq 1$

X2 is one of the coefficients of the porosity in the equation of Anagonye and Wang [1999]. (Defined below in description for X0/X1)

If $X0 = 0$

GE.0.0: X2, in this context named FLC, is an optional fabric porous leakage flow coefficient.

LT.0.0: |FLC| is the load curve ID of the curve defining FLC versus time.

If $X0 = 1$ GE.0.0: See $X0 = 0$ above.LT.0.0: |FLC| is the load curve ID defining FLC versus the stretching ratio defined as $r_s = A/A_0$. See notes below.

FAC/X3

If $X0 \neq 0$ and $X0 \neq 1$

X3 is one of the coefficients of the porosity in the equation of Anagonye and Wang [1999]. (Defined below in description for X0/X1)

If $X0 = 0$ and $FVOPT < 7$

GE.0.0: X3, in this context named FAC, is an optional fabric characteristic parameter.

LT.0.0: |FAC| is the load curve ID of the curve defining FAC

versus absolute pressure.

If X0 = 1 and FVOPT < 7

GE.0.0: See X0 = 0 and FVOPT < 7 above.

LT.0.0: |FAC| is the load curve ID defining FAC versus the pressure ratio defined as $r_p = P_{air}/P_{bag}$. See remark 3 of *MAT_FABRIC.

If (X0 = 0 or X0 = 1) and (FVOPT = 7 or FVOPT = 8)

GE.0.0: See X0 = 0 and FVOPT < 7 above.

LT.0.0: FAC defines leakage volume flux rate versus absolute pressure. The volume flux (per area) rate (per time) has the unit of velocity and it is equivalent to relative porous gas speed.

$$\left[\frac{d(\text{Vol}_{\text{flux}})}{dt} \right] = \frac{[\text{volume}]}{[\text{area}]} \frac{1}{[\text{time}]} = \frac{[\text{length}]}{[\text{time}]} = [\text{velocity}],$$

ELA Effective leakage area for blocked fabric, ELA.

LT.0.0: |ELA| is the load curve ID of the curve defining ELA versus time. The default value of zero assumes that no leakage occurs. A value of .10 would assume that 10% of the blocked fabric is leaking gas.

FVOPT Fabric venting option.

EQ.1: Wang-Nefske formulas for venting through an orifice are used. Blockage is not considered.

EQ.2: Wang-Nefske formulas for venting through an orifice are used. Blockage of venting area due to contact is considered.

EQ.3: Leakage formulas of Graefe, Krummheuer, and Siejak [1990] are used. Blockage is not considered.

EQ.4: Leakage formulas of Graefe, Krummheuer, and Siejak [1990] are used. Blockage of venting area due to contact is considered.

EQ.5: Leakage formulas based on flow through a porous media are used. Blockage is not considered.

EQ.6: Leakage formulas based on flow through a porous media are used. Blockage of venting area due to contact is considered.

EQ.7: Leakage is based on gas volume outflow versus pressure

load curve [Lian, 2000]. Blockage is not considered. Absolute pressure is used in the porous-velocity-versus-pressure load curve, given as FAC.

EQ.8: Leakage is based on gas volume outflow versus pressure load curve [Lian 2000]. Blockage of venting or porous area due to contact is considered. Absolute pressure is used in the porous-velocity-versus-pressure load curve, given as FAC.

X0, X1

Coefficients of Anagonye and Wang [1999] porosity equation for the leakage area:

$$A_{\text{leak}} = A_0(X_0 + X_1 r_s + X_2 r_p + X_3 r_s r_p)$$

***MAT_ADD_COHESIVE**

The ADD_COHESIVE option offers the possibility to use a selection of 3-dimensional material models in LS-DYNA in conjunction with cohesive elements.

Usually the cohesive elements (ELFORM = 19 and 20 of *SECTION_SOLID) can only be used with a small subset of materials (41-50, 138, 184, 185, 186, 240). But with this additional keyword, a bigger amount of standard 3-d material models can be used, that would only be available for solid elements in general. Currently the following material models are supported: 1, 3, 4, 6, 15, 24, 41-50, 81, 82, 89, 96, 98, 103, 104, 105, 106, 107, 115, 120, 123, 124, 141, 168, 173, 187, 188, 193, 224, 225, 252, and 255.

Card 1	1	2	3	4	5	6	7	8
Variable	PID	ROFLG	INTFAIL	THICK				
Type	I	F	F	F				
Default	none	0.0	0.0	0.0				

VARIABLE**DESCRIPTION**

PID

Part ID for which the cohesive property applies.

ROFLG

Flag for whether density is specified per unit area or volume.

EQ.0.0: Density specified per unit volume (default).

EQ.1.0: Density specified per unit area for controlling the mass of cohesive elements with an initial volume of zero.

INTFAIL

The number of integration points required for the cohesive element to be deleted. If it is zero, the element won't be deleted even if it satisfies the failure criterion. The value of INTFAIL may range from 1 to 4, with 1 the recommended value.

THICK

Thickness of the adhesive layer.

EQ.0.0: The actual thickness of the cohesive element is used.

GT.0.0: User specified thickness.

Remarks:

Cohesive elements possess 3 kinematic variables, namely two relative displacements δ_1, δ_2 in tangential directions and one relative displacement δ_3 in normal direction. In a corresponding constitutive model, they are used to compute 3 associated traction stresses t_1, t_2 , and t_3 , e.g. in the elastic case (*MAT_COHESIVE_ELASTIC):

$$\begin{bmatrix} t_1 \\ t_2 \\ t_3 \end{bmatrix} = \begin{bmatrix} E_T & 0 & 0 \\ 0 & E_T & 0 \\ 0 & 0 & E_N \end{bmatrix} \begin{bmatrix} \delta_1 \\ \delta_2 \\ \delta_3 \end{bmatrix}$$

On the other hand, hypoelastic 3-d material models for standard solid elements are formulated with respect to 6 independent strain rates and 6 associated stress rates, e.g. for isotropic elasticity (*MAT_ELASTIC):

$$\begin{bmatrix} \dot{\sigma}_{xx} \\ \dot{\sigma}_{yy} \\ \dot{\sigma}_{zz} \\ \dot{\sigma}_{xy} \\ \dot{\sigma}_{yz} \\ \dot{\sigma}_{zx} \end{bmatrix} = \frac{E}{(1+\nu)(1-2\nu)} \begin{bmatrix} 1-\nu & \nu & \nu & 0 & 0 & 0 \\ \nu & 1-\nu & \nu & 0 & 0 & 0 \\ \nu & \nu & 1-\nu & 0 & 0 & 0 \\ 0 & 0 & 0 & 1-2\nu & 0 & 0 \\ 0 & 0 & 0 & 0 & 1-2\nu & 0 \\ 0 & 0 & 0 & 0 & 0 & 1-2\nu \end{bmatrix} \begin{bmatrix} \dot{\epsilon}_{xx} \\ \dot{\epsilon}_{yy} \\ \dot{\epsilon}_{zz} \\ \dot{\epsilon}_{xy} \\ \dot{\epsilon}_{yz} \\ \dot{\epsilon}_{zx} \end{bmatrix}$$

To be able to use such 3-dimensional material models in a cohesive element environment, an assumption is necessary to transform 3 relative displacements to 6 strain rates. Therefore it is assumed that no lateral expansion and no in-plane shearing is possible for the cohesive element:

$$\begin{bmatrix} \delta_1 \\ \delta_2 \\ \delta_3 \end{bmatrix} \rightarrow \begin{bmatrix} \dot{\epsilon}_{xx} \\ \dot{\epsilon}_{yy} \\ \dot{\epsilon}_{zz} \\ \dot{\epsilon}_{xy} \\ \dot{\epsilon}_{yz} \\ \dot{\epsilon}_{zx} \end{bmatrix} = \begin{bmatrix} 0 \\ 0 \\ \dot{\delta}_3/(t + \delta_3) \\ 0 \\ \dot{\delta}_2/(t + \delta_3) \\ \dot{\delta}_1/(t + \delta_3) \end{bmatrix}$$

where t is the initial thickness of the adhesive layer, see parameter THICK. These strain rates are then used in a 3-d constitutive model to obtain new Cauchy stresses, where 3 components can finally be used for the cohesive element:

$$\begin{bmatrix} \sigma_{xx} \\ \sigma_{yy} \\ \sigma_{zz} \\ \sigma_{xy} \\ \sigma_{yz} \\ \sigma_{zx} \end{bmatrix} \rightarrow \begin{bmatrix} t_1 \\ t_2 \\ t_3 \end{bmatrix} = \begin{bmatrix} \sigma_{zx} \\ \sigma_{yz} \\ \sigma_{zz} \end{bmatrix}$$

If this keyword is used in combination with a 3-dimensional material model, the output to D3PLOT or ELOUT is organized as in other material models for cohesive elements, see e.g. *MAT_184. Instead of the usual six stress components, three traction stresses are written

into those databases. The in-plane shear traction along the 1-2 edge replaces the x-stress, the orthogonal in-plane shear traction replaces the y-stress, and the traction in the normal direction replaces the z-stress.

***MAT_ADD_EROSION**

Many of the constitutive models in LS-DYNA do not allow failure and erosion. The ADD_EROSION option provides a way of including failure in these models. This option can also be applied to constitutive models that already include other failure/erosion criterion.

Each of the failure criteria defined here are applied independently, and once a sufficient number of those criteria are satisfied according to NCS, the element is deleted from the calculation.

In addition to erosion, GISSMO damage or alternative damage initiation and evolution models are available as described in the remarks. See variable IDAM.

This option applies to nonlinear element formulations including the 2D continuum, 3D solid elements, 3D shell elements, and the thick shell elements types 1 and 2. Beam types 1 and 11 currently support the erosion but not the damage and evolution models.

Card 1	1	2	3	4	5	6	7	8
Variable	MID	EXCL	MXPRES	MNEPS	EFFEPS	VOLEPS	NUMFIP	NCS
Type	A8	F	F	F	F	F	F	F
Default	none	none	0.0	0.0	0.0	0.0	1.0	1.0

Card 2	1	2	3	4	5	6	7	8
Variable	MNPRES	SIGP1	SIGVM	MXEPS	EPSSH	SIGTH	IMPULSE	FAILTM
Type	F	F	F	F	F	F	F	F
Default	none	none	none	none	none	none	none	none

The following card is optional:

Card 3	1	2	3	4	5	6	7	8
Variable	IDAM	DMGTYP	LCSDG	ECRIT	DMGEXP	DCRIT	FADEXP	LCREGD
Type	A8	F	F	F	F	F	F	F
Default	0.0	0.0	0.0	0.0	1.0	0.0	1.0	0.0

Additional card for IDAM > 0.

Card 4	1	2	3	4	5	6	7	8
Variable	SIZFLG	REFSZ	NAHSV	LCSRS	SHRF	BIAXF		
Type	F	F	F	F	F	F		
Default	0.0	0.0	0.0	0.0	0.0	0.0		

Damage Initiation and Evolution Card Pairs. For IDAM < 0 include | IDAM | pairs of cards using Cards 5 and 6.

Card 5	1	2	3	4	5	6	7	8
Variable	DITYP	P1	P2					
Type	F	F	F					
Default	0.0	0.0	0.0					

Card 6	1	2	3	4	5	6	7	8
Variable	DEtyp	DCTYP	Q1					
Type	F	F	F					
Default	0.0	0.0	0.0					

Optional Card with additional failure criteria.

Card 7	1	2	3	4	5	6	7	8
Variable	LCFLD		EPSTHIN	ENGCRt	RADCRt			
Type	F		F	F	F			
Default	0.0		0.0	0.0	0.0			

VARIABLE**DESCRIPTION**

MID	Material identification for which this erosion definition applies. A unique number or label not exceeding 8 characters must be specified.
EXCL	The exclusion number, which applies to the values defined on Card 2. When any of the failure constants are set to the exclusion number, the associated failure criteria calculations are bypassed (which reduces the cost of the failure model). For example, to prevent a material from going into tension, the user should specify an unusual value for the exclusion number, e.g., 1234., set P_{\min} to 0.0 and all the remaining constants to 1234. The default value is 0.0, which eliminates all criteria from consideration that have their constants set to 0.0 or left blank in the input file.
MXPRES	Maximum pressure at failure, P_{\max} . If the value is exactly zero, it is automatically excluded to maintain compatibility with old input files.
MNEPS	Minimum principal strain at failure, ϵ_{\min} . If the value is exactly zero, it is automatically excluded to maintain compatibility with old input files.

VARIABLE	DESCRIPTION
EFFEPS	Maximum effective strain at failure, $\varepsilon_{eff} = \sqrt{2/3 \varepsilon_{ij}^{dev} \varepsilon_{ij}^{dev}}$. If the value is exactly zero, it is automatically excluded to maintain compatibility with old input files. If the value is negative, then $ \text{EFFEPS} $ is the effective plastic strain to failure. In combination with cohesive elements, EFFEPS is the maximum effective in-plane strain.
VOLEPS	Volumetric strain at failure, $\varepsilon_{vol} = \varepsilon_{11} + \varepsilon_{22} + \varepsilon_{33}$, or $\ln(\text{relative volume})$. VOLEPS can be a positive or negative number depending on whether the failure is in tension or compression, respectively. If the value is exactly zero, it is automatically excluded to maintain compatibility with old input files.
NUMFIP	<p>Number of failed integration points prior to element deletion. The default is unity. See Remark 10.</p> <p>LT.0.0 (IDAM = 0): Only for shells. NUMFIP is the percentage of integration points which must exceed the failure criterion before element fails. If $\text{NUMFIP} < -100$, then $\text{NUMFIP} - 100$ is the number of failed integration points prior to element deletion.</p> <p>LT.0.0 (IDAM \neq 0): Only for shells. NUMFIP is the percentage of layers which must fail before element fails. For shell formulations with 4 integration points per layer, the layer is considered failed if any of the integration points in the layer fails.</p>
NCS	Number of failure conditions to satisfy before failure occurs. For example, if SIGP1 and SIGVM are defined and if $\text{NCS} = 2$, both failure criteria must be met before element deletion can occur. The default is set to unity.
MNPRES	Minimum pressure at failure, P_{\min} .
SIGP1	Principal stress at failure, σ_{\max} .
SIGVM	Equivalent stress at failure, $\bar{\sigma}_{\max}$. The equivalent stress at failure is made a function of the effective strain rate by setting SIGVM to the negative of the appropriate load curve ID.

VARIABLE	DESCRIPTION
MXEPS	Maximum principal strain at failure, ϵ_{\max} . The maximum principal strain at failure is made a function of the effective strain rate by setting MXEPS to the negative of the appropriate load curve ID.
EPSSH	Shear strain at failure, γ_{\max} .
SIGTH	Threshold stress, σ_0 .
IMPULSE	Stress impulse for failure, K_f .
FAILTM	Failure time. When the problem time exceeds the failure time, the material is removed.
IDAM	Flag for damage model. EQ.0: no damage model is used. EQ.1: GISSMO damage model. LT.0: -IDAM represents the number of damage initiation and evolution criteria to be applied

VARIABLE	DESCRIPTION
DMGTYP	<p data-bbox="475 260 1161 296"><u>For GISSMO damage type the following applies.</u></p> <p data-bbox="475 306 1117 342">DMGTYP is interpreted digit-wise as follows:</p> $DMGTYP = [NM] = M + 10 \times N$ <p data-bbox="508 432 1409 501">M.EQ.0: Damage is accumulated, no coupling to flow stress, no failure.</p> <p data-bbox="508 527 1409 638">M.EQ.1: Damage is accumulated, element failure occurs for $D = 1$. Coupling of damage to flow stress depending on parameters, see remarks below.</p> <p data-bbox="508 663 1409 848">N.EQ.0: Equivalent plastic strain is the driving quantity for the damage. (To be more precise, it's the history variable that LS-PrePost blindly labels as "plastic strain". What this history variable actually represents depends on the material model.)</p> <p data-bbox="508 873 1409 1100">N.GT.0: The Nth "additional" history variable number such as is written for solids when NEIPH > 0 or for shells when NEIPS > 0 in *DATABASE_EXTENT_BINARY. For example, N = 6 in the case of *MAT_187 solids would make volumetric plastic strain the driving quantity for the GISSMO damage.</p>
	<u>For IDAM.LT.0 the following applies.</u>
	<p data-bbox="508 1178 854 1213">EQ.0: No action is taken</p> <p data-bbox="508 1236 1409 1346">EQ.1: Damage history is initiated based on values of initial plastic strains and initial strain tensor, this is to be used in multi-stage analyses</p>
LCSDG	<p data-bbox="475 1392 1409 1541">Load curve ID or Table ID. Load curve defines equivalent plastic strain to failure vs. triaxiality. Table defines for each Lode parameter value (between -1 and 1) a load curve ID giving the equivalent plastic strain to failure vs. triaxiality for that Lode parameter value.</p>
ECRIT	<p data-bbox="475 1581 1224 1617">Critical plastic strain (material instability), see below.</p> <p data-bbox="508 1640 1409 1709">LT.0.0: ECRIT is load curve ID defining critical equivalent plastic strain vs: triaxiality.</p> <p data-bbox="508 1734 1409 1803">EQ.0.0: Fixed value DCRIT defining critical damage is read (see below)</p> <p data-bbox="508 1829 1409 1894">GT.0.0: Fixed value for stress-state independent critical equivalent plastic strain.</p>

VARIABLE	DESCRIPTION
DMGEXP	Exponent for nonlinear damage accumulation, see remarks.
DCRIT	Damage threshold value (critical damage). If a Load curve of critical plastic strain or fixed value is given by ECRIT, input is ignored.
FADEXP	Exponent for damage-related stress fadeout. LT.0.0: FADEXP is load curve ID defining element-size dependent fading exponent. GT.0.0: Constant fading exponent.
LCREGD	Load curve ID defining element size dependent regularization factors for equivalent plastic strain to failure in the GISSMOdel. This feature can also be used with the standard (non-GISSMO) failure criteria of Cards 1 (MXPRES, MNEPS, EFFEPS, VOLEPS), 2 (MNPRES, SIGP1, SIGVM, MXEPS, EPSSH, IMPULSE) and 4 (EPSTHIN), i.e. when IDAM = 0.
SIZFLG	Flag for method of element size determination. EQ.0: (default) Element size is determined in undeformed configuration as square root of element area (shells), or cubic root of element volume (solids), respectively. EQ.1: Element size is updated every time step, and determined as mean edge length (this option was added to ensure compatibility with *MAT_120, and is not recommended for general purpose).
REFSZ	Reference element size, for which an additional output of damage will be generated. This is necessary to ensure the applicability of resulting damage quantities when transferred to different mesh sizes.
NAHSV	Number of history variables from damage model which should be stored in standard material history array for Postprocessing. See remarks.

VARIABLE	DESCRIPTION
LCSRS	Load curve ID defining failure strain scaling factor for LCSDG vs. strain rate. If the first strain rate value in the curve is negative, it is assumed that all strain rate values are given as natural logarithm of the strain rate. GT.0: scale ECRIT, too LT.0: do not scale ECRIT.
SHRF	Reduction factor for regularization at triaxiality = 0 (shear)
BIAXF	Reduction factor for regularization at triaxiality = 2/3 (biaxial)
DITYP	Damage initiation type EQ.0.0: Ductile EQ.1.0: Shear EQ.2.0: MSFLD EQ.3.0: FLD
P1	Damage initiation parameter DITYP.EQ.0.0: Load curve/table ID representing plastic strain at onset of damage as function of stress triaxiality and optionally plastic strain rate. DITYP.EQ.1.0: Load curve/table ID representing plastic strain at onset of damage as function of shear influence and optionally plastic strain rate. DITYP.EQ.2.0: Load curve/table ID representing plastic strain at onset of damage as function of ratio of principal plastic strain rates and optionally plastic strain rate. DITYP.EQ.3.0: Load curve/table ID representing plastic strain at onset of damage as function of ratio of principal plastic strain rates and optionally plastic strain rate.

VARIABLE	DESCRIPTION
P2	<p>Damage initiation parameter</p> <p>DITYP.EQ.0.0: Not used</p> <p>DITYP.EQ.1.0: Pressure influence coefficient k_S</p> <p>DITYP.EQ.2.0: Not used</p> <p>DITYP.EQ.3.0: Not used</p>
DETYP	<p>Damage evolution type</p> <p>EQ.0.0: Linear softening, evolution of damage is a function of the plastic displacement after the initiation of damage.</p> <p>EQ.1.0: Linear softening, evolution of damage is a function of the fracture energy after the initiation of damage.</p>
DCTYP	<p>Damage composition option for multiple criteria</p> <p>EQ.0.0: Maximum</p> <p>EQ.1.0: Multiplicative</p>
Q1	<p>Damage evolution parameter</p> <p>DETYP.EQ.0.0: Plastic displacement at failure, u_f^p, a negative value corresponds to a table ID for u_f^p as a function of triaxiality and damage.</p> <p>DETYP.EQ.1.0: Fracture energy at failure, G_f,</p>
LCFLD	<p>Load curve ID defining the Forming Limit Diagram. Minor strains in percent are defined as abscissa values and Major strains in percent are defined as ordinate values. The forming limit diagram is shown in Figure 2-28. In defining the curve, list pairs of minor and major strains starting with the left most point and ending with the right most point. This criterion is only for shell elements and it is available starting with Release 971 R6.</p>
EPSTHIN	<p>Thinning strain at failure for thin and thick shells.</p> <p>GT.0.0: individual thinning for each integration point from z-strain</p> <p>LT.0.0: averaged thinning strain from element thickness change</p>
ENGCRT	<p>Critical energy for nonlocal failure criterion, see item 9 below.</p>

VARIABLE	DESCRIPTION
RADCRT	Critical radius for nonlocal failure criterion, see item 9 below.

In addition to failure time, supported criteria for failure are:

1. $P \geq P_{\max}$, where P is the pressure (positive in compression), and P_{\max} is the maximum pressure at failure.
2. $\varepsilon_3 \leq \varepsilon_{\min}$, where ε_3 is the minimum principal strain, and ε_{\min} is the minimum principal strain at failure.
3. $P \leq P_{\min}$, where P is the pressure (positive in compression), and P_{\min} is the minimum pressure at failure.
4. $\sigma_1 \geq \sigma_{\max}$, where σ_1 is the maximum principal stress, and σ_{\max} is the maximum principal stress at failure.
5. $\sqrt{\frac{3}{2} \sigma'_{ij} \sigma'_{ij}} \geq \bar{\sigma}_{\max}$, where σ'_{ij} are the deviatoric stress components, and $\bar{\sigma}_{\max}$ is the equivalent stress at failure.
6. $\varepsilon_1 \geq \varepsilon_{\max}$, where ε_1 is the maximum principal strain, and ε_{\max} is the maximum principal strain at failure.
7. $\gamma_1 \geq \gamma_{\max}$, where γ_1 is the maximum shear strain = $(\varepsilon_1 - \varepsilon_3)/2$, and γ_{\max} is the shear strain at failure.
8. The Tuler-Butcher criterion,

$$\int_0^t [\max(0, \sigma_1 - \sigma_0)]^2 dt \geq K_f,$$

where σ_1 is the maximum principal stress, σ_0 is a specified threshold stress, $\sigma_1 \geq \sigma_0 \geq 0$, and K_f is the stress impulse for failure. Stress values below the threshold value are too low to cause fracture even for very long duration loadings.

9. A nonlocal failure criterion which is mainly intended for windshield impact can be defined via ENGCRIT, RADCRT, and one additional "main" failure criterion (only SIGP1 is available at the moment). All three parameters should be defined for one part, namely the windshield glass and the glass should be discretized with shell elements. The course of events of this nonlocal failure model is as follows: If the main failure criterion SIGP1 is fulfilled, the corresponding element is flagged as center of impact, but no element erosion takes place yet. Then, the internal energy of shells inside a circle, defined by RADCRT, around the center of impact is tested against the product of the given critical energy ENGCRIT and the "area factor". The area factor is defined as,

$$\text{Area Factor} = \frac{\text{total area of shell elements found inside the circle}}{2\pi \times \text{RADCRT}^2}$$

The reason for having two times the circle area in the denominator is that we expect two layers of shell elements, as would typically be the case for laminated windshield glass.. If this energy criterion is exceeded, all elements of the part are now allowed to be eroded by the main failure criterion.

10. When $IDAM = 0$, there are 3 ways to specify how shell elements are eroded and removed from the calculation. When $NUMFIP > 0$, elements erode when $NUMFIP$ points fail. When $-100 \leq NUMFIP < 0$, elements erode when $|NUMFIP|$ percent of the integration points fail. When $NUMFIP < -100$, elements erode when $|NUMFIP|-100$ points fail. For $NUMFIP > 0$ and $-100 \leq NUMFIP < 0$, layers retain full strength until the element is eroded. For $NUMFIP < -100$, the stress at an integration point immediately drops to zero when failure is detected at that integration point.

When $IDAM \neq 0$, there are 2 ways to specify how shell elements are eroded and removed from the calculation. When $NUMFIP > 0$, elements erode when $NUMFIP$ points fail. When $NUMFIP < 0$, elements erode when $|NUMFIP|$ percent of the layers fail. A layer fails if any integration point within that layer fails. When $IDAM = 0$, erosion is in terms of failed points, not layers.

DAMAGE MODELS

GISSMO:

The GISSMO damage model is a phenomenological formulation that allows for an incremental description of damage accumulation, including softening and failure. It is intended to provide a maximum in variability for the description of damage for a variety of metallic materials (e.g. *MAT_024, *MAT_036, ...). The input of parameters is based on tabulated data, allowing the user to directly convert test data to numerical input.

The model is based on an incremental formulation of damage accumulation:

$$\Delta D = \frac{DMGEXP \times D^{(1 - \frac{1}{DMGEXP})}}{\varepsilon_f} \Delta \varepsilon_p$$

where,

- D Damage value ($0 \leq D \leq 1$). For numerical reasons, D is initialized to a value of 1.E-20 for all damage types in the first time step
- ε_f Equivalent plastic strain to failure, determined from LCSDG as a function of the current triaxiality value η .

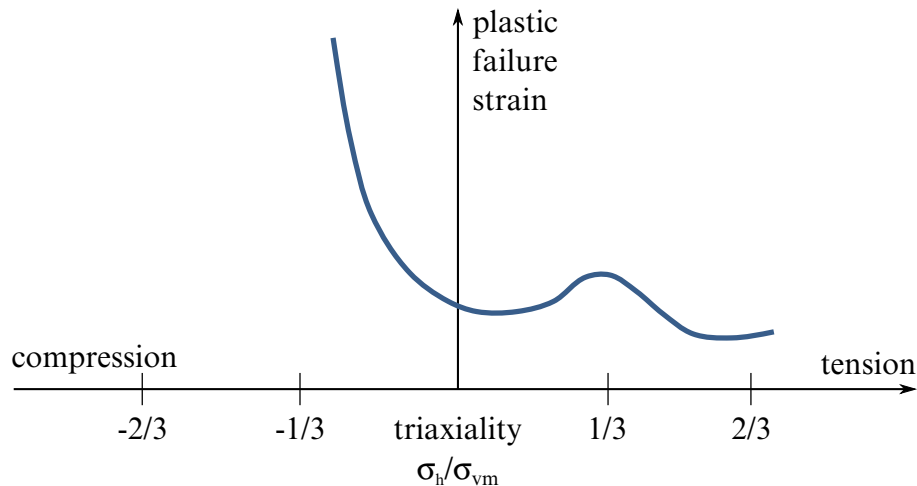

Figure 2-1. Typical failure curve for metal sheet, modeled with shell elements.

A typical failure curve LCSDG for metal sheet, modelled with shell elements is shown in [Figure 2-1](#). Triaxiality should be monotonically increasing in this curve. A reasonable range for triaxiality is $-2/3$ to $2/3$ if shell elements are used (plane stress).

For 3-dimensional stress states (solid elements), the possible range of triaxiality goes from $-\infty$ to $+\infty$, but to get a good resolution in the internal load curve discretization (depending on parameter LCINT of *CONTROL_SOLUTION) one should define lower limits, e.g. -1 to 1 if LCINT = 100 (default).

$\Delta\varepsilon_p$ Equivalent plastic strain increment

For constant values of failure strain, this damage rate can be integrated to get a relation of damage and actual equivalent plastic strain:

$$D = \left(\frac{\varepsilon_p}{\varepsilon_f} \right)^{\text{DMGEXP}}, \quad \text{for } \varepsilon_f = \text{const. only!}$$

Triaxiality η as a measure of the current stress state is defined as

$$\eta = \frac{\sigma_H}{\sigma_M}, \quad \text{with hydrostatic stress } \sigma_H \text{ and equivalent von Mises stress } \sigma_M.$$

For DMGTYP.EQ.0, damage is accumulated according to the description above, yet no softening and failure is taken into account. Thus, parameters ECRIT, DCRIT and FADEXP will not have any influence. This option can be used to calculate pre-damage in multi-stage deformations without influencing the simulation results.

For DMGTYP.EQ.1, elements will be deleted if $D \geq 1$.

Depending on the set of parameters given by ECRIT (or DCRIT) and FADEXP, a Lemaitre-type coupling of damage and stress (*effective stress concept*) can be used.

Three principal ways of damage definition can be used:

1. Input of a fixed value of critical plastic strain (ECRIT.GT.0.)

As soon as the magnitude of plastic strain reaches this value, the current damage parameter D is stored as critical damage $DCRIT$ and the damage coupling flag is set to unity, in order to facilitate an identification of critical elements in postprocessing. From this point on, damage is coupled to the stress tensor using the following relation:

$$\sigma = \tilde{\sigma} \left[1 - \left(\frac{D - DCRIT}{1 - DCRIT} \right)^{FADEXP} \right]$$

This leads to a continuous reduction of stress, up to the load-bearing capacity completely vanishing as D reaches unity. The fading exponent $FADEXP$ can be defined element size dependent, to allow for the consideration of an element-size dependent amount of energy to be dissipated during element fade-out.

2. Input of a load curve defining critical plastic strain vs. triaxiality (ECRIT.LT.0.), pointing to load curve ID |ECRIT|. This allows for a definition of triaxiality-dependent material instability, which takes account of that instability and localization will occur depending on the actual load case. This offers the possibility to use a transformed Forming Limit Diagram as an input for the expected onset of softening and localization. Using this load curve, the instability measure F is accumulated using the following relation, which is similar to the accumulation of damage D except for the instability curve is used as an input:

$$\Delta F = \frac{DMGEXP}{\varepsilon_{p,loc}} F^{\left(1 - \frac{1}{DMGEXP}\right)} \Delta \varepsilon_p$$

with,

F Instability measure ($0 \leq F \leq 1$).

$\varepsilon_{p,loc}$ Equivalent plastic strain to instability, determined from ECRIT

$\Delta \varepsilon_p$ Equivalent plastic strain increment

As soon as the instability measure F reaches unity, the current value of damage D in the respective element is stored. Damage will from this point on be coupled to the flow stress using the relation described above

3. If no input for ECRIT is made, parameter $DCRIT$ will be considered.

Coupling of Damage to the stress tensor starts if this value (*damage threshold*) is exceeded ($0 \leq DCRIT \leq 1$). Coupling of damage to stress is done using the relation described above.

This input allows for the use of extreme values also – for example, $DCRIT = 0.0$ would lead to no coupling at all, and element deletion under full load (brittle fracture).

History Variables:

History variables of the GISSMO damage model are written to the postprocessing database only if NAHSV > 0. The damage history variables start at position ND, which is displayed in d3hsp file, e.g. "first damage history variable = 6" means that ND = 6.

<u>Variable</u>	<u>Description</u>
ND	Damage parameter D (1.E-20 ≤ D ≤ 1)
ND+1	Damage threshold DCRIT
ND+2	Domain flag for damage coupling (0: no coupling, 1: coupling)
ND+3	Triaxiality variable σ_H/σ_M
ND+4	Equivalent plastic strain
ND+5	Regularization factor for failure strain (determined from LCREGD)
ND+6	Exponent for stress fading FADEXP
ND+7	Calculated element size
ND+8	Instability measure F
ND+9	Resultant damage parameter D for element size REFSZ
ND+10	Resultant damage threshold DCRIT for element size REFSZ
ND+11	Averaged triaxiality
ND+12	Lode parameter value
ND+13	Alternative damage value: $D^{1/DMGEXP}$

DAMAGE INITIATION AND EVOLUTION CRITERIA:

As an alternative to GISSMO, the user may invoke an arbitrary number of damage initiation and evolution criteria, the number of course in practice being limited by the number of available criteria. With this option the following theory applies.

Assuming that n initiation/evolution types have been specified in the input deck ($n = -IDAM$) there is defined at each integration point a damage initiation variable, ω_D^i , and an evolution history variable D^i , such that,

$$\omega_D^i \in [0, \infty[$$

and

$$D^i \in [0,1], i = 1, \dots n.$$

These are initially set to zero and evolve with the deformation of the elements according to rules associated with the specific damage initiation and evolution type chosen, see below for details.

These quantities can be post-processed as ordinary material history variables and their positions in the history variables array is given in d3hsp, search for the string *Damage history listing*. The damage initiation variables do not influence the results but serve to indicate the onset of damage.

The damage evolution variables govern the damage in the material and are used to form the global damage $D \in [0,1]$. Each criterion is of either of DCTYP set to maximum (DCTYP = 0) or multiplicative (DCTYP = 1). Letting I_{\max} denote the set of evolution types with DCTYP set to maximum and I_{mult} denote the set of evolution types with DCTYP set to multiplicative the global damage, D , is defined as

$$D = \max(D_{\max}, D_{\text{mult}}),$$

where

$$D_{\max} = \max_{i \in I_{\max}} D^i$$

and,

$$D_{\text{mult}} = 1 - \prod_{i \in I_{\text{mult}}} (1 - D^i).$$

The damage variable relates the macroscopic (damaged) to microscopic (true) stress by

$$\sigma = (1 - D)\tilde{\sigma}.$$

Once the damage has reached the level of D_{erode} (=0.99 by default) the stress is set to zero and the integration point is assumed failed and not processed thereafter. For NUMFIP > 0, a shell element is eroded and removed from the finite element model when NUMFIP integration points have failed.

DAMAGE INITIATION, ω_D

For each evolution type i , ω_D^i governs the onset of damage. For $i \neq j$ the evolution of ω_D^i is independent from the evolution of ω_D^j . The following list enumerates the algorithms for modelling damage initiation.

In this subsection we suppress the superscripted i indexing the evolution type.

Ductile (DITYP.EQ.0):

For the ductile initiation option a function $\varepsilon_D^p = \varepsilon_D^p(\eta, \dot{\varepsilon}^p)$ represents the plastic strain at onset of damage (P1). This is a function of stress triaxiality defined as

$$\eta = -p/q$$

with p being the pressure and q the von Mises equivalent stress. Optionally this can be defined as a table with the second dependency being on the effective plastic strain rate $\dot{\varepsilon}^p$. The damage initiation history variable evolves according to

$$\omega_D = \int_0^{\varepsilon^p} \frac{d\varepsilon^p}{\varepsilon_D^p}.$$

Shear (DITYP.EQ.1):

For the shear initiation option a function $\varepsilon_D^p = \varepsilon_D^p(\theta, \dot{\varepsilon}^p)$ represents the plastic strain at onset of damage (P1). This is a function of a shear stress function defined as

$$\theta = (q + k_s p) / \tau$$

with p being the pressure, q the von Mises equivalent stress and τ the maximum shear stress defined as a function of the principal stress values

$$\tau = (\sigma_{\text{major}} - \sigma_{\text{minor}}) / 2.$$

Introduced here is also the pressure influence parameter k_s (P2). Optionally this can be defined as a table with the second dependency being on the effective plastic strain rate $\dot{\varepsilon}^p$. The damage initiation history variable evolves according to

$$\omega_D = \int_0^{\varepsilon^p} \frac{d\varepsilon^p}{\varepsilon_D^p}.$$

MSFLD (DITYP.EQ.2):

For the MSFLD initiation option a function $\varepsilon_D^p = \varepsilon_D^p(\alpha, \dot{\varepsilon}^p)$ represents the plastic strain at onset of damage (P1). This is a function of the ratio of principal plastic strain rates defined as

$$\alpha = \frac{\dot{\varepsilon}_{\text{minor}}^p}{\dot{\varepsilon}_{\text{major}}^p}.$$

The MSFLD criterion is only relevant for shells and the principal strains should be interpreted as the in-plane principal strains. For simplicity the plastic strain evolution in this formula is assumed to stem from an associated von Mises flow rule and whence

$$\alpha = \frac{s_{\text{minor}}}{s_{\text{major}}}$$

with s being the deviatoric stress. This assures that the calculation of α is in a sense robust at the expense of being slightly off for materials with anisotropic yield functions and/or non-associated flow rules. Optionally this can be defined as a table with the second dependency being on the effective plastic strain rate $\dot{\varepsilon}^p$, for $\dot{\varepsilon}^p = 0$ the value of ε_D^p is set to a large number to prevent onset of damage for no plastic evolution. Furthermore, the plastic strain used in this failure criteria is a modified effective plastic strain that only evolves when the pressure is negative, i.e., the material is not affected in compression. This modified plastic strain can be monitored as the second history variable of the initiation history variables in the binary output database. The damage initiation history variable evolves according to

$$\omega_D = \max_{t \leq T} \frac{\varepsilon^p}{\varepsilon_D^p},$$

which should be interpreted as the maximum value up to this point in time. An important note with this initiation option is that the damage initiation variable is evaluated using the strains and stresses at the mid-surface of the shell and thus bending effects are not taken into account.

FLD (DITYP.EQ.3):

This initiation option is very similar to DITYP = 2, the only difference being the damage initiation history variable that here evolves as

$$\omega_D = \int_0^{\varepsilon^p} \frac{d\varepsilon^p}{\varepsilon_D^p}$$

and where plastic strain here refers to the non-modified ditto, i.e, it is not affected by the pressure as for the MSFLD option.

For the evolution of the associated damage variable D we introduce the plastic displacement u^p which evolves according to

$$\dot{u}^p = \begin{cases} 0 & \omega_D < 1 \\ l\dot{\varepsilon}^p & \omega_D \geq 1 \end{cases}$$

with l being a characteristic length of the element. Fracture energy is related to plastic displacement as follows

$$G_f = \int_0^{u_f^p} \sigma_y du^p$$

where σ_y is the yield stress.

DAMAGE PARAMETER, D

The following list enumerates the algorithms available for modelling damage.

Linear (DETYP.EQ.0):

With this option the damage variable evolves linearly with the plastic displacement

$$\dot{D} = \frac{\dot{u}^p}{u_f^p}$$

with u_f^p being the plastic displacement at failure (Q1). If Q1 is negative, then -Q1 refers to a table that defines u_f^p as a function of triaxiality and damage, i.e., $u_f^p = u_f^p(\eta, D)$, and importantly the damage evolution law is changed generalized to

$$\dot{D} = \frac{\dot{u}^p}{\frac{\partial u_f^p}{\partial D}}$$

Linear (DETYP.EQ.1):

With this option the damage variable evolves linearly as follows

$$\dot{D} = \frac{\dot{u}^p}{u_f^p}$$

where $u_f^p = 2G_f / \sigma_{y_0}$ and σ_{y_0} is the yield stress when failure criterion is reached.

***MAT_ADD_PERMEABILITY**

For consolidation calculations.

Card 1	1	2	3	4	5	6	7	8
Variable	MID	PERM	(blank)	(blank)	THEXP	LCKZ		
Type	I	F			F	I		
Default	none	none			0.0	none		

VARIABLE**DESCRIPTION**

MID	Material identification – must be same as the structural material.
PERM	Permeability
THEXP	Undrained volumetric thermal expansion coefficient (Units: 1/temperature)
LCKZ	Loadcurve giving factor on PERM versus z-coordinate. (X-axis – z-coordinate, yaxis – non dimensional factor)

Remarks:

The units of PERM are length/time (volume flow rate of water per unit area per gradient of head of excess pore pressure head).

See notes under *CONTROL_PORE_FLUID

*MAT_ADD_PORE_AIR

For pore air pressure calculations.

Card 1	1	2	3	4	5	6	7	8
Variable	MID	PA_RHO	PA_PRE	PORE				
Type	I	I	F	F				
Default	none	AIR_RO	AIR_RO	1.				
Remarks	1			1,2				

Card 2	1	2	3	4	5	6	7	8
Variable	PERM1	PERM1	PERM3	CDARCY	CDF	LCPGD1	LCPGD2	LCPGD3
Type	F	F	F	F	F	I	I	I
Default	0.	PERM1	PERM1	1.	0.	none	LCPGD1	LCPGD1
Remarks	2,3,4,5	2,3,4,5	2,3,4,5	1	1,5	6	6	6

VARIABLE

DESCRIPTION

MID	Material identification – must be same as the structural material.
PA_RHO	Initial density of pore air, default to atmospheric air density, AIR_RO, defined in *CONTROL_PORE_AIR
PA_PRE	Initial pressure of pore air, default to atmospheric air pressure, AIR_P, defined in *CONTROL_PORE_AIR
PORE	Porosity, ratio of pores to total volume, default to 1.
PERM1~3	Permeability of pore air along x, y and z-direction, < 0 when its absolute magnitude is the curve defining permeability coefficient as a function of volume ratio, current-volume/volume-at-stress-free-state.

VARIABLE	DESCRIPTION
CDARCY	Coefficient of Darcy's law
CDF	Coefficient of Dupuit-Forchheimer law
LCPGD1~3	Curves defining non-linear Darcy's laws along x, y and z-directions, see Remarks 6.

Remarks:

1. This card must be defined for all materials requiring consideration of pore air pressure. The pressure contribution of pore air is $(\rho - \rho_{\text{atm}}) \times RT \times \text{PORE}$, where ρ and ρ_{atm} are the current and atmospheric air density, R is air's gas constant, T is atmospheric air temperature and PORE is the porosity. All R , T and VAR are assumed to be constant during simulation.
2. The unit of PERM_i is length³*time/mass, (air flow velocity per gradient of excess pore pressure), i.e.

$$(\text{CDARCY} + \text{CDF} \times |\mathbf{v}_{\text{ai}}|) \times \text{PORE} \times \mathbf{v}_{\text{ai}} = \text{PERM}_i \times \frac{\partial P_a}{\partial x_i}, \quad i = 1,2,3$$

where \mathbf{v}_{ai} is the pore air flow velocity along the i 'th direction, $\partial P_a / \partial x_i$ is the pore air pressure gradient along the i 'th direction, and $x_1 = x$, $x_2 = y$, $x_3 = z$.

3. PERM_2 and PERM_3 are assumed to be equal to PERM_1 when they are not defined. A definition of "0" means no permeability.
4. (x,y,z) , or $(1,2,3)$, refers to the local material coordinate system (a,b,c) when MID is an orthotropic material, like *MAT_002 or *MAT_142; otherwise it refers to the global coordinate system.
5. CDF can be used to consider the viscosity effect for high speed air flow
6. LCGDC_i can be used to define a non-linear Darcy's law as follows:

$$(\text{CDARCY} + \text{CDF} \times |\mathbf{v}_{\text{ai}}|) \times \text{PORE} \times \mathbf{v}_{\text{ai}} = \text{PERM}_i \times f_i \frac{\partial P_a}{\partial x_i}, \quad i = 1,2,3$$

where f_i is the function value of LCPGD_i . The linear Darcy's law, Remarks 2, can be recovered when LCPGD_i are defined as straight lines with a slope of 1.

***MAT_ADD_THERMAL_EXPANSION**

The ADD_THERMAL_EXPANSION option is used to occupy an arbitrary material model in LS-DYNA with a thermal expansion property. This option applies to all nonlinear solid, shell, thick shell and beam elements and all material models except those models which use resultant formulations such as *MAT_RESULTANT_PLASTICITY and *MAT_SPECIAL_ORTHO-TROPIC. Orthotropic expansion effects are supported for anisotropic materials.

Card 1	1	2	3	4	5	6	7	8
Variable	PID	LCID	MULT	LCIDY	MULTY	LCIDZ	MULTZ	
Type	I	I	F	I	F	I	F	
Default	none	none	1.0	LCID	MULT	LCID	MULT	

VARIABLE**DESCRIPTION**

PID	Part ID for which the thermal expansion property applies
LCID	For isotropic material models, LCIDY, MULTY, LCIDZ, and MULTZ are ignored, and LCID is the load curve ID defining the thermal expansion coefficient as a function of temperature. If zero, the thermal expansion coefficient is constant and equal to MULT. For anisotropic material models, LCID and MULT define the thermal expansion coefficient in the local material a-direction.
MULT	Scale factor scaling load curve given by LCID.
LCIDY	Load curve ID defining the thermal expansion coefficient in local material b-direction as a function of temperature. If zero, the thermal expansion coefficient in the local material b-direction is constant and equal to MULTY. If MULTY = 0 as well, LCID and MULT define the thermal expansion coefficient in the local material b-direction.
MULTY	Scale factor scaling load curve given by LCIDY.

VARIABLE	DESCRIPTION
LCIDZ	Load curve ID defining the thermal expansion coefficient in local material c-direction as a function of temperature. If zero, the thermal expansion coefficient in the local material c-direction is constant and equal to MULTZ. If MULTZ = 0 as well, LCID and MULT define the thermal expansion coefficient in the local material c-direction.
MULTZ	Scale factor scaling load curve given by LCIDZ.

Remarks:

When invoking the isotropic thermal expansion property (no use of the local y and z parameters) for a material, the stress update is based on the elastic strain rates given by

$$\dot{\epsilon}_{ij}^e = \dot{\epsilon}_{ij} - \alpha(T)\dot{T}\delta_{ij}$$

rather than on the total strain rates $\dot{\epsilon}_{ij}$. For a material with the stress based on the deformation gradient F_{ij} , the elastic part of the deformation gradient is used for the stress computations

$$F_{ij}^e = J_T^{-1/3}F_{ij}$$

where J_T is the thermal Jacobian. The thermal Jacobian is updated using the rate given by

$$\dot{J}_T = 3\alpha(T)\dot{T}J_T.$$

For orthotropic properties, which apply only to materials with anisotropy, these equations are generalized to

$$\dot{\epsilon}_{ij}^e = \dot{\epsilon}_{ij} - \alpha_k(T)\dot{T}q_{ik}q_{jk}$$

and

$$F_{ij}^e = F_{ik}\beta_l^{-1}Q_{kl}Q_{jl}$$

where the β_i are updated as

$$\dot{\beta}_i = \alpha_i(T)\dot{T}\beta_i.$$

Here q_{ij} represents the matrix with material directions with respect to the current configuration whereas Q_{ij} are the corresponding directions with respect to the initial configuration. For (shell) materials with multiple layers of different anisotropy directions, the mid surface layer determines the orthotropy for the thermal expansion.

*MAT_NONLOCAL

In nonlocal failure theories, the failure criterion depends on the state of the material within a radius of influence which surrounds the integration point. An advantage of nonlocal failure is that mesh size sensitivity on failure is greatly reduced leading to results which converge to a unique solution as the mesh is refined. Without a nonlocal criterion, strains will tend to localize randomly with mesh refinement leading to results which can change significantly from mesh to mesh. The nonlocal failure treatment can be a great help in predicting the onset and the evolution of material failure. This option can be used with two and three-dimensional solid elements, and three-dimensional shell elements and thick shell elements. This option applies to a subset of elastoplastic materials that include a damage-based failure criterion.

Card 1	1	2	3	4	5	6	7	8
Variable	IDNL	PID	P	Q	L	NFREQ	NHV	
Type	I	I	F	F	F	I	I	
Default	none	none	none	none	none	none	none	

History Cards. Include as many cards as needed to set NHV variables. *One card 2 will be read even if NHV = 0.*

Card 2	1	2	3	4	5	6	7	8
Variable	NL1	NL2	NL3	NL4	NL5	NL6	NL7	NL8
Type	I	I	I	I	I	I	I	I
Default	none	none	none	none	none	none	none	none

Symmetry Plane Cards. Define one card for each symmetry plane. Up to six symmetry planes can be defined. The next "*" card terminates this input.

Cards 3	1	2	3	4	5	6	7	8
Variable	XC1	YC1	ZC1	XC2	YC2	ZC2		
Type	F	F	F	F	F	F		
Default	none	none	none	none	none	none		

VARIABLE	DESCRIPTION
IDNL	Nonlocal material input ID.
PID	Part ID for nonlocal material.
P	Exponent of weighting function. A typical value might be 8 depending somewhat on the choice of L. See equations below.
Q	Exponent of weighting function. A typical value might be 2. See equations below.
L	Characteristic length. This length should span a few elements. See equations below.
NFREQ	Number of time steps between update of neighbors. The nearest neighbor search can add significant computational time so it is suggested that NFREQ be set to value of 10 to 100 depending on the problem. This parameter may be somewhat problem dependent.
NHV	Define the number of history variables to be smoothed.
NL1, ..., NL8	Define up to eight history variable ID's per line for nonlocal treatment.
XC1, YC1, ZC1	Coordinate of point on symmetry plane.
XC2, YC2, ZC2	Coordinate of a point along the normal vector.

Remarks:

For elastoplastic material models in LS-DYNA which use the plastic strain as a failure criterion, the first history variable, which does not count the six stress components, is the plastic strain. In this case, the variable NL1 = 1 and NL2 to NL8 = 0. See the table below, which lists the history variable ID's for a subset of materials.

Material Model Name	Effective Plastic Strain Location	Damage Parameter Location
PLASTIC_KINEMTAIC	1	N/A
JOHNSON_COOK	1	5 (shells); 7 (solids)
PIECEWISE_LINEAR_PLASTICITY	1	N/A
PLASTICITY_WITH_DAMAGE	1	2
MODIFIED_ZERILLI-ARMSTRONG	1	N/A
DAMAGE_1	1	4
DAMAGE_2	1	2
MODIFIED_PIECEWISE_LINEAR_PLAST	1	N/A
PLASTICITY_COMPRESSION_TENSION	1	N/A
JOHNSON_HOLMQUIST_CONCRETE	1	2
GURSON	1	2

In applying the nonlocal equations to shell and thick shell elements, integration points lying in the same plane within the radius determined by the characteristic length are considered. Therefore, it is important to define the connectivity of the shell elements consistently within the part ID, e.g., so that the outer integration points lie on the same surface.

The equations and our implementation are based on the implementation by Worswick and Lalbin [1999] of the nonlocal theory to Pijaudier-Cabot and Bazant [1987]. Let Ω_r be the neighborhood of radius, L , of element e_r and $\{e_i\}_{i=1,\dots,N_r}$ the list of elements included in Ω_r , then

$$\dot{f}_r = \dot{f}(x_r) = \frac{1}{W_r} \int_{\Omega_r} \dot{f}_{\text{local}} w(x_r - y) dy \approx \frac{1}{W_r} \sum_{i=1}^{N_r} \dot{f}_{\text{local}}^i w_{ri} V_i$$

where

$$W_r = W(x_r) = \int w(x_r - y) dy \approx \sum_{i=1}^{N_r} w_{ri} V_i$$

$$w_{ri} = w(x_r - y_i) = \frac{1}{\left[1 + \left(\frac{\|x_r - y_i\|}{L}\right)^p\right]^q}$$

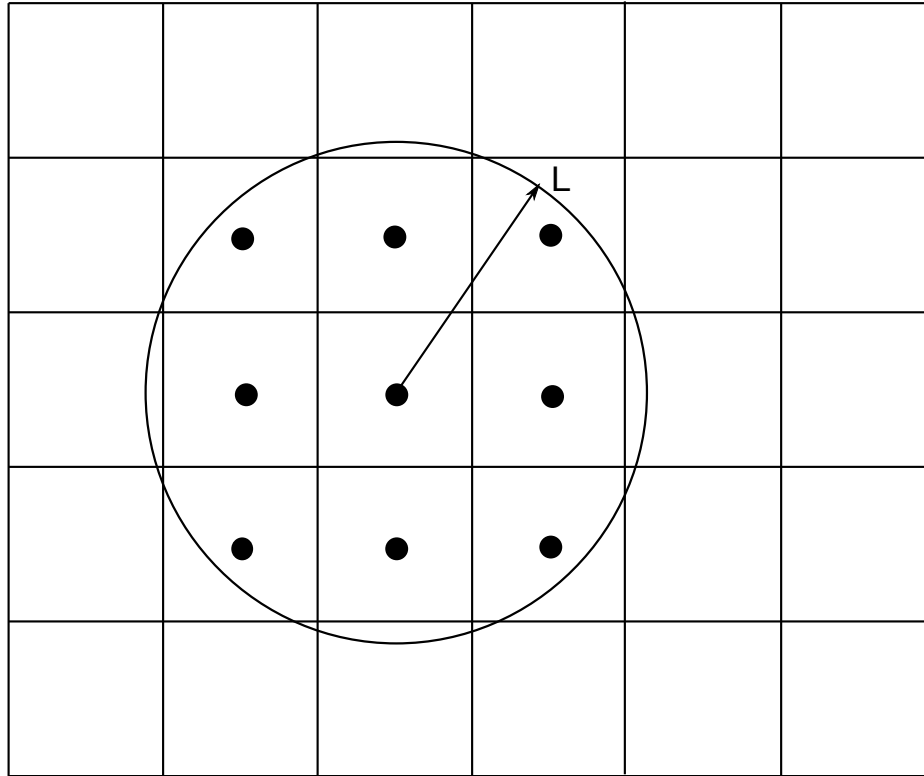

Figure 2-2. Here \dot{f}_r and x_r are respectively the nonlocal rate of increase of damage and the center of the element e_r , and \dot{f}_{local}^i , V_i and y_i are respectively the local rate of increase of damage, the volume and the center of element e_i .

***MAT_ELASTIC_{OPTION}**

This is Material Type 1. This is an isotropic hypoelastic material and is available for beam, shell, and solid elements in LS-DYNA. A specialization of this material allows the modeling of fluids.

Available options include:

<BLANK>

FLUID

such that the keyword cards appear:

*MAT_ELASTIC or MAT_001

*MAT_ELASTIC_FLUID or MAT_001_FLUID

The fluid option is valid for solid elements only.

Card 1	1	2	3	4	5	6	7	8
Variable	MID	R0	E	PR	DA	DB	K	
Type	A8	F	F	F	F	F	F	
Default	none	none	none	0.0	0.0	0.0	0.0	

Additional card for FLUID keyword option.

Card 2	1	2	3	4	5	6	7	8
Variable	VC	CP						
Type	F	F						
Default	none	1.0E+20						

VARIABLE

DESCRIPTION

MID

Material identification. A unique number or label not exceeding 8 characters must be specified.

VARIABLE	DESCRIPTION
RO	Mass density.
E	Young's modulus.
PR	Poisson's ratio.
DA	Axial damping factor (used for Belytschko-Schwer beam, type 2, only).
DB	Bending damping factor (used for Belytschko-Schwer beam, type 2, only).
K	Bulk Modulus (define for fluid option only).
VC	Tensor viscosity coefficient, values between .1 and .5 should be okay.
CP	Cavitation pressure (default = 1.0e+20).

Remarks:

This hypoelastic material model may not be stable for finite (large) strains. If large strains are expected, a hyperelastic material model, e.g., *MAT_002, would be more appropriate.

The axial and bending damping factors are used to damp down numerical noise. The update of the force resultants, F_i , and moment resultants, M_i , includes the damping factors:

$$F_i^{n+1} = F_i^n + \left(1 + \frac{DA}{\Delta t}\right) \Delta F_i^{n+\frac{1}{2}}$$

$$M_i^{n+1} = M_i^n + \left(1 + \frac{DB}{\Delta t}\right) \Delta M_i^{n+\frac{1}{2}}$$

The history variable labeled as "plastic strain" by LS-PrePost is actually volumetric strain in the case of *MAT_ELASTIC.

For the fluid option the bulk modulus (K) has to be defined as Young's modulus and Poisson's ratio is ignored. With the fluid option fluid-like behavior is obtained where the bulk modulus, K, and pressure rate, \dot{p} , are given by:

$$K = \frac{E}{3(1 - 2\nu)}$$

$$\dot{p} = -K \dot{\epsilon}_{ii}$$

and the shear modulus is set to zero. A tensor viscosity is used which acts only the deviatoric stresses, S_{ij}^{n+1} , given in terms of the damping coefficient as:

$$S_{ij}^{n+1} = VC \times \Delta L \times a \times \rho \dot{\epsilon}'_{ij}$$

where ΔL is a characteristic element length, a is the fluid bulk sound speed, ρ is the fluid density, and $\dot{\epsilon}'_{ij}$ is the deviatoric strain rate.

***MAT_{OPTION}TROPIC_ELASTIC**

This is Material Type 2. This material is valid for modeling the elastic-orthotropic behavior of solids, shells, and thick shells. An anisotropic option is available for solid elements. For orthotropic solids an isotropic frictional damping is available.

In the case of solids, stresses are calculated not from incremental strains but rather from the deformation gradient. Also for solids, the elastic constants are formulated in terms of second Piola-Kirchhoff stress and Green’s strain, however, Cauchy stress is output.

In the case of shells, the stress update is incremental and the elastic constraints are formulated in terms of Cauchy stress and true strain.

Available options include:

ORTHO

ANISO

such that the keyword cards appear:

*MAT_ORTHOTROPIC_ELASTIC or MAT_002 (4 cards follow)

*MAT_ANISOTROPIC_ELASTIC or MAT_002_ANIS (5 cards follow)

Orthotropic Card 1. Card 1 for ORTHO keyword option.

Card 1	1	2	3	4	5	6	7	8
Variable	MID	RO	EA	EB	EC	PRBA	PRCA	PRCB
Type	A8	F	F	F	F	F	F	F

Orthotropic Card 2. Card 2 for ORTHO keyword option.

Card 2	1	2	3	4	5	6	7	8
Variable	GAB	GBC	GCA	AOPT	G	SIGF		
Type	F	F	F	F	F	F		

Anisotropic Card 1. Card 1 for ANISO keyword option.

Card 1	1	2	3	4	5	6	7	8
Variable	MID	R0	C11	C12	C22	C13	C23	C33
Type	A8	F	F	F	F	F	F	F

Anisotropic Card 2. Card 2 for ANISO keyword option.

Card 2	1	2	3	4	5	6	7	8
Variable	C14	C24	C34	C44	C15	C25	C35	C45
Type	F	F	F	F	F	F	F	F

Anisotropic Card 3. Card 3 for ANISO keyword option.

Card 3	1	2	3	4	5	6	7	8
Variable	C55	C16	C26	C36	C46	C56	C66	AOPT
Type	F	F	F	F	F	F	F	F

Regardless of the specified keyword option, include cards 4 and 5.

Card 4	1	2	3	4	5	6	7	8
Variable	XP	YP	ZP	A1	A2	A3	MACF	IHIS
Type	F	F	F	F	F	F	I	F

Card 5	1	2	3	4	5	6	7	8
Variable	V1	V2	V3	D1	D2	D3	BETA	REF
Type	F	F	F	F	F	F	F	F

VARIABLE	DESCRIPTION
MID	Material identification. A unique number or label not exceeding 8 characters must be specified.
RO	Mass density.

Define for the ORTHO option only:

EA	E_a , Young's modulus in a-direction.
EB	E_b , Young's modulus in b-direction.
EC	E_c , Young's modulus in c-direction (nonzero value required but not used for shells).
PRBA	ν_{ba} , Poisson's ratio ba.
PRCA	ν_{ca} , Poisson's ratio ca.
PRCB	ν_{cb} , Poisson's ratio cb.
GAB	G_{ab} , shear modulus ab.
GBC	G_{bc} , shear modulus bc.
GCA	G_{ca} , shear modulus ca.

Due to symmetry define the upper triangular C_{ij} 's for the ANISO option only:

C11	The 1,1 term in the 6×6 anisotropic constitutive matrix. Note that 1 corresponds to the a material direction
C12	The 1,2 term in the 6×6 anisotropic constitutive matrix. Note that 2 corresponds to the b material direction
⋮	⋮
C66	The 6,6 term in the 6×6 anisotropic constitutive matrix.

Define AOPT for both options:

AOPT	Material axes option, see Figure 2-3 . EQ.0.0: locally orthotropic with material axes determined by element nodes as shown in part (a) of Figure 2-3 . The a-direction is from node 1 to node 2 of the element. The b-direction is orthogonal to the a-direction and is in the plane formed by nodes 1, 2, and 4. When this option is used in two-dimensional planar and axisymmetric analy-
------	---

sis, it is critical that the nodes in the element definition be numbered counterclockwise for this option to work correctly.

EQ.1.0: locally orthotropic with material axes determined by a point in space and the global location of the element center; this is the a-direction. This option is for solid elements only.

EQ.2.0: globally orthotropic with material axes determined by vectors defined below, as with *DEFINE_COORDINATE_VECTOR.

EQ.3.0: locally orthotropic material axes determined by rotating the material axes about the element normal by an angle, BETA, from a line in the plane of the element defined by the cross product of the vector v with the element normal. The plane of a solid element is the midsurface between the inner surface and outer surface defined by the first four nodes and the last four nodes of the connectivity of the element, respectively.

EQ.4.0: locally orthotropic in cylindrical coordinate system with the material axes determined by a vector v, and an originating point, P, which define the centerline axis. This option is for solid elements only.

LT.0.0: the absolute value of AOPT is a coordinate system ID number (CID on *DEFINE_COORDINATE_NODES, *DEFINE_COORDINATE_SYSTEM or *DEFINE_COORDINATE_VECTOR). Available in R3 version of 971 and later.

G Shear modulus for frequency independent damping. Frequency independent damping is based of a spring and slider in series. The critical stress for the slider mechanism is SIGF defined below. For the best results, the value of G should be 250-1000 times greater than SIGF. This option applies only to solid elements.

SIGF Limit stress for frequency independent, frictional, damping.

XP, YP, ZP Define coordinates of point p for AOPT = 1 and 4.

A1, A2, A3 Define components of vector a for AOPT = 2.

MACF Material axes change flag for brick elements:
EQ.1: No change, default,

	EQ.2: switch material axes a and b,
	EQ.3: switch material axes a and c,
	EQ.4: switch material axes b and c.
IHIS	Flag for anisotropic stiffness terms initialization (for solid elements only). EQ.0: C11, C12, ... from Cards 1, 2, and 3 are used. EQ.1: C11, C12, ... are initialized by *INITIAL_STRESS_SOLID's history data.
V1, V2, V3	Define components of vector v for AOPT = 3 and 4.
D1, D2, D3	Define components of vector d for AOPT = 2.
BETA	Material angle in degrees for AOPT = 3, may be overridden on the element card, see *ELEMENT_SHELL_BETA or *ELEMENT_SOLID_ORTHO.
REF	Use reference geometry to initialize the stress tensor. The reference geometry is defined by the keyword: *INITIAL_FOAM_REFERENCE_GEOMETRY (see there for more details). EQ.0.0: off, EQ.1.0: on.

Remarks:

The material law that relates stresses to strains is defined as:

$$\mathbf{C} = \mathbf{T}^T \mathbf{C}_L \mathbf{T}$$

where \mathbf{T} is a transformation matrix, and \mathbf{C}_L is the constitutive matrix defined in terms of the material constants of the orthogonal material axes, a, b, and c. The inverse of \mathbf{C}_L for the orthotropic case is defined as:

$$C_L^{-1} = \begin{bmatrix} \frac{1}{E_a} & -\frac{\nu_{ba}}{E_b} & -\frac{\nu_{ca}}{E_c} & 0 & 0 & 0 \\ -\frac{\nu_{ab}}{E_a} & \frac{1}{E_b} & -\frac{\nu_{cb}}{E_c} & 0 & 0 & 0 \\ -\frac{\nu_{ac}}{E_a} & -\frac{\nu_{bc}}{E_b} & \frac{1}{E_c} & 0 & 0 & 0 \\ 0 & 0 & 0 & \frac{1}{G_{ab}} & 0 & 0 \\ 0 & 0 & 0 & 0 & \frac{1}{G_{bc}} & 0 \\ 0 & 0 & 0 & 0 & 0 & \frac{1}{G_{ca}} \end{bmatrix}$$

Where,

$$\frac{\nu_{ab}}{E_a} = \frac{\nu_{ba}}{E_b}, \frac{\nu_{ca}}{E_c} = \frac{\nu_{ac}}{E_a}, \frac{\nu_{cb}}{E_c} = \frac{\nu_{bc}}{E_b}.$$

The frequency independent damping is obtained by having a spring and slider in series as shown in the following sketch:

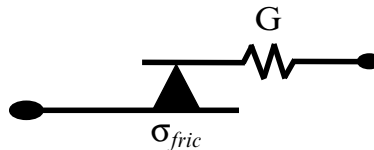

This option applies only to orthotropic solid elements and affects only the deviatoric stresses.

The procedure for describing the principle material directions is explained for solid and shell elements for this material model and other anisotropic materials. We will call the material direction the **a-b-c** coordinate system. The AOPT options illustrated in [Figure 2-3](#) can define the **a-b-c** system for all elements of the parts that use the material, but this is not the final material direction. There **a-b-c** system defined by the AOPT options may be offset by a final rotation about the **c**-axis. The offset angle we call BETA.

For solid elements, the BETA angle is specified in one of two ways. When using AOPT = 3, the BETA parameter defines the offset angle for all elements that use the material. The BETA parameter has no meaning for the other AOPT options. Alternatively, a BETA angle can be defined for individual solid elements as described in remark 5 for *ELEMENT_SOLID_ORTHO. The beta angle by the ORTHO option is available for all values of AOPT, and it overrides the BETA angle on the *MAT card for AOPT = 3.

The directions determined by the material AOPT options may be overridden for individual elements as described in remark 3 for *ELEMENT_SOLID_ORTHO. However, be aware that for materials with AOPT = 3, the final **a-b-c** system will be the system defined on the element card rotated about **c**-axis by the BETA angle specified on the *MAT card.

There are two fundamental differences between shell and solid element orthotropic materials. First, the **c**-direction is always normal to a shell element such that the **a**-direction and **b**-directions are within the plane of the element. Second, for some anisotropic materials, shell elements may have unique fiber directions within each layer through the thickness of the element so that a layered composite can be modeled with a single element.

When $AOPT = 0$ is used in two-dimensional planar and axisymmetric analysis, it is critical that the nodes in the element definition be numbered counterclockwise for this option to work correctly.

Because shell elements have their **c**-axes defined by the element normal, $AOPT = 1$ and $AOPT = 4$ are not available for shells. Also, $AOPT = 2$ requires only the vector **a** be defined since **d** is not used. The shell procedure projects the inputted **a**-direction onto each element surface.

Similar to solid elements, the **a-b-c** direction determined by $AOPT$ is then modified by a rotation about the **c**-axis which we will call ϕ . For those materials that allow a unique rotation angle for each integration point through the element thickness, the rotation angle is calculated by

$$\phi_i = \beta + \beta_i$$

where β is a rotation for the element, and β_i is the rotation for the i 'th layer of the element. The β angle can be input using the **BETA** parameter on the ***MAT** data, or will be overridden for individual elements if the **BETA** keyword option for ***ELEMENT_SHELL** is used. The β_i angles are input using the **ICOMP = 1** option of ***SECTION_SHELL** or with ***PART_COMPOSITE**. If β or β_i is omitted, they are assumed to be zero.

All anisotropic shell materials have the **BETA** option on the ***MAT** card available for both $AOPT = 0$ and $AOPT = 3$, except for materials 91 and 92 which have it available for all values of $AOPT$, 0, 2, and 3.

All anisotropic shell materials allow an angle for each integration point through the thickness, β_i , except for materials 2, 86, 91, 92, 117, 130, 170, 172, and 194.

This discussion of material direction angles in shell elements also applies to thick shell elements which allow modeling of layered composites using ***INTEGRATION_SHELL** or ***PART_COMPOSITE_TSHELL**.

AOPT = 0.0

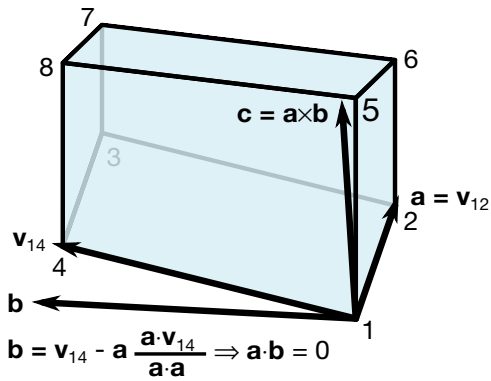

AOPT = 1.0

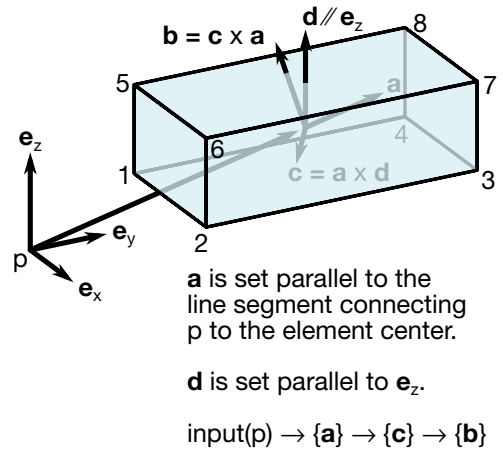

AOPT = 2.0 (solid)

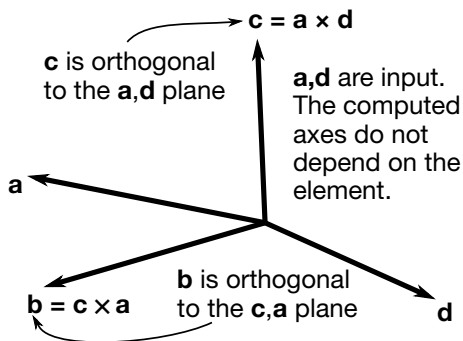

AOPT = 2.0 (shell)

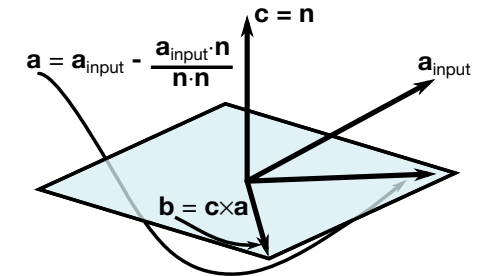

AOPT = 3.0

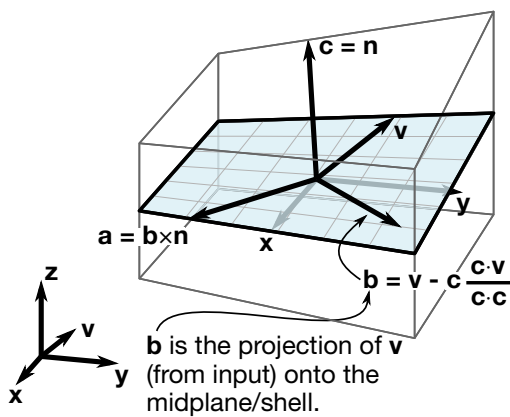

AOPT = 4.0

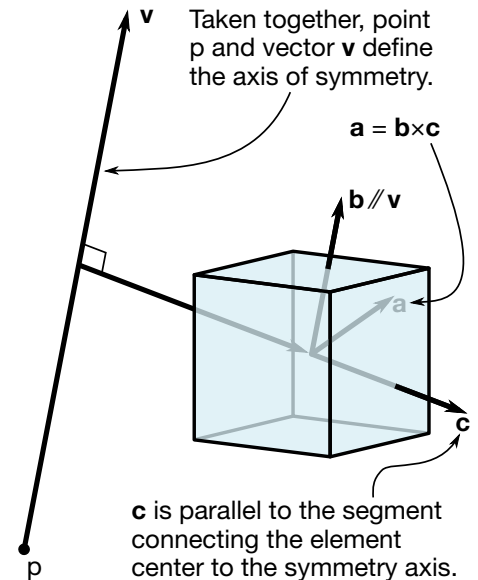

Figure 2-3: Illustration of for AOPT

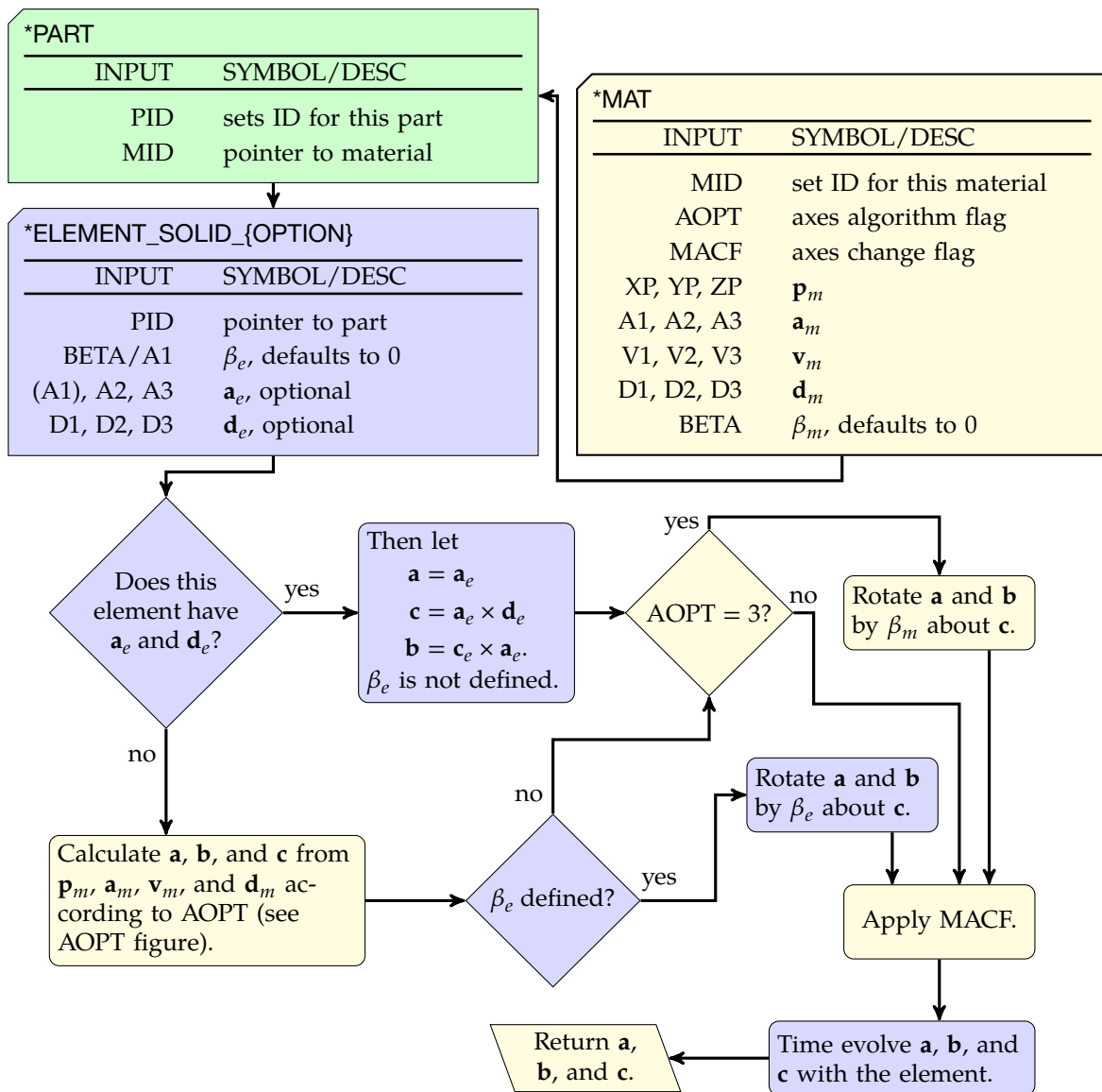

Figure 2-4. Flow chart showing how for each solid element LS-DYNA determines the vectors $\{a, b, c\}$ from the input.

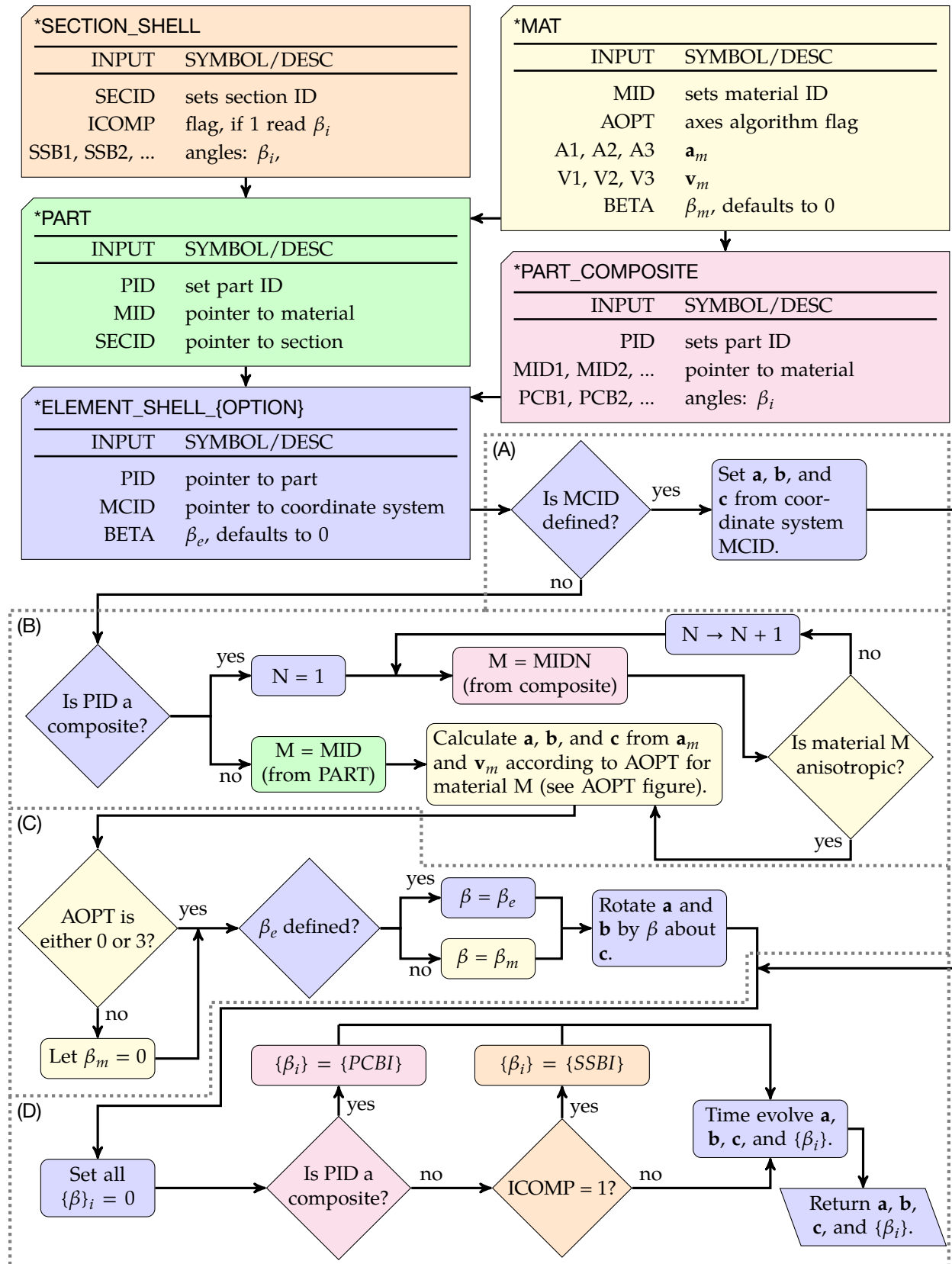

Figure 2-5. Flowchart for shells: (a) check for coordinate system ID; (b) process AOPT; (c) determine β ; and (d) for each layer determine β_i .

***MAT_PLASTIC_KINEMATIC**

This is Material Type 3. This model is suited to model isotropic and kinematic hardening plasticity with the option of including rate effects. It is a very cost effective model and is available for beam (Hughes-Liu and Truss), shell, and solid elements.

Card 1	1	2	3	4	5	6	7	8
Variable	MID	RO	E	PR	SIGY	ETAN	BETA	
Type	A8	F	F	F	F	F	F	
Default	none	none	none	none	none	0.0	0.0	

Card 2	1	2	3	4	5	6	7	8
Variable	SRC	SRP	FS	VP				
Type	F	F	F	F				
Default	not used	not used	1.E+20	0.0				

VARIABLE**DESCRIPTION**

MID	Material identification. A unique number or label not exceeding 8 characters must be specified.
RO	Mass density.
E	Young's modulus.
PR	Poisson's ratio.
SIGY	Yield stress.
ETAN	Tangent modulus, see Figure 2-6
BETA	Hardening parameter, $0 < \beta' < 1$. See comments below.
SRC	Strain rate parameter, C , for Cowper Symonds strain rate model, see below. If zero, rate effects are not considered..

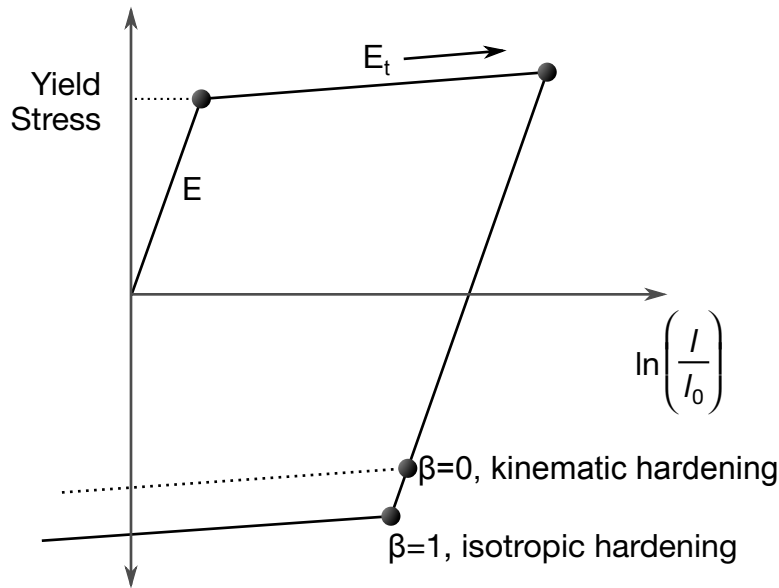

Figure 2-6. Elastic-plastic behavior with kinematic and isotropic hardening where l_0 and l are undeformed and deformed lengths of uniaxial tension specimen. E_t is the slope of the bilinear stress strain curve.

VARIABLE	DESCRIPTION
SRP	Strain rate parameter, P, for Cowper Symonds strain rate model, see below. If zero, rate effects are not considered.
FS	Effective plastic strain for eroding elements.
VP	Formulation for rate effects: EQ.0.0: Scale yield stress (default), EQ.1.0: Viscoplastic formulation

Remarks:

Strain rate is accounted for using the Cowper and Symonds model which scales the yield stress with the factor

$$1 + \left(\frac{\dot{\epsilon}}{C}\right)^{1/p}$$

where $\dot{\epsilon}$ is the strain rate. A fully viscoplastic formulation is optional which incorporates the Cowper and Symonds formulation within the yield surface. An additional cost is incurred but the improvement allows for dramatic results. To ignore strain rate effects set both SRC and SRP to zero.

Kinematic, isotropic, or a combination of kinematic and isotropic hardening may be specified by varying β' between 0 and 1. For β' equal to 0 and 1, respectively, kinematic and isotropic hardening are obtained as shown in [Figure 2-6](#). For isotropic hardening, $\beta' = 1$, Material Model 12, *MAT_ISOTROPIC_ELASTIC_PLASTIC, requires less storage and is more efficient. Whenever possible, Material 12 is recommended for solid elements, but for shell elements it is less accurate and thus Material 12 is not recommended in this case.

***MAT_ELASTIC_PLASTIC_THERMAL**

This is Material Type 4. Temperature dependent material coefficients can be defined. A maximum of eight temperatures with the corresponding data can be defined. A minimum of two points is needed. When this material type is used it is necessary to define nodal temperatures by activating a coupled analysis or by using another option to define the temperatures such as *LOAD_THERMAL_LOAD_CURVE, or *LOAD_THERMAL_VARIABLE.

Card 1	1	2	3	4	5	6	7	8
Variable	MID	R0						
Type	A8	F						

Card 2	1	2	3	4	5	6	7	8
Variable	T1	T2	T3	T4	T5	T6	T7	T8
Type	F	F	F	F	F	F	F	F

Card 3	1	2	3	4	5	6	7	8
Variable	E1	E2	E3	E4	E5	E6	E7	E8
Type	F	F	F	F	F	F	F	F

Card 4	1	2	3	4	5	6	7	8
Variable	PR1	PR2	PR3	PR4	PR5	PR6	PR7	PR8
Type	F	F	F	F	F	F	F	F

No defaults are assumed.

Card 5	1	2	3	4	5	6	7	8
Variable	ALPHA1	ALPHA2	ALPHA3	ALPHA4	ALPHA5	ALPHA6	ALPHA7	ALPHA8
Type	F	F	F	F	F	F	F	F

Card 6	1	2	3	4	5	6	7	8
Variable	SIGY1	SIGY2	SIGY3	SIGY4	SIGY5	SIGY6	SIGY7	SIGY8
Type	F	F	F	F	F	F	F	F

Card 7	1	2	3	4	5	6	7	8
Variable	ETAN1	ETAN2	ETAN3	ETAN4	ETAN5	ETAN6	ETAN7	ETAN8
Type	F	F	F	F	F	F	F	F

VARIABLE**DESCRIPTION**

MID	Material identification. A unique number or label not exceeding 8 characters must be specified.
RO	Mass density.
TI	Temperatures. The minimum is 2, the maximum is 8.
EI	Corresponding Young's moduli at temperature TI.
PRI	Corresponding Poisson's ratios.
ALPHA1	Corresponding coefficients of thermal expansion.
SIGY1	Corresponding yield stresses.
ETAN1	Corresponding plastic hardening moduli.

Remarks:

At least two temperatures and their corresponding material properties must be defined. The analysis will be terminated if a material temperature falls outside the range defined in the input. If a thermoelastic material is considered, do not define SIGY and ETAN. The coefficient of thermal expansion is defined as the instantaneous value. Thus, the thermal strain rate becomes:

$$\dot{\varepsilon}_{ij}^T = \alpha \dot{T} \delta_{ij}$$

***MAT_SOIL_AND_FOAM**

This is Material Type 5. This is a very simple model and works in some ways like a fluid. It should be used only in situations when soils and foams are confined within a structure or when geometric boundaries are present. A table can be defined if thermal effects are considered in the pressure versus volumetric strain behavior.

Card 1	1	2	3	4	5	6	7	8
Variable	MID	RO	G	KUN	A0	A1	A2	PC
Type	A8	F	F	F	F	F	F	F

Card 2	1	2	3	4	5	6	7	8
Variable	VCR	REF	LCID					
Type	F	F	F					

Card 3	1	2	3	4	5	6	7	8
Variable	EPS1	EPS2	EPS3	EPS4	EPS5	EPS6	EPS7	EPS8
Type	F	F	F	F	F	F	F	F

Card 4	1	2	3	4	5	6	7	8
Variable	EPS9	EPS10						
Type	F	F						

Card 5	1	2	3	4	5	6	7	8
Variable	P1	P2	P3	P4	P5	P6	P7	P8
Type	F	F	F	F	F	F	F	F

Card 6	1	2	3	4	5	6	7	8
Variable	P9	P10						
Type	F	F						

VARIABLE

DESCRIPTION

MID	Material identification. A unique number or label not exceeding 8 characters must be specified.
RO	Mass density.
G	Shear modulus.
KUN	Bulk modulus for unloading used for VCR = 0.0.
A0	Yield function constant for plastic yield function below.
A1	Yield function constant for plastic yield function below.
A2	Yield function constant for plastic yield function below.
PC	Pressure cutoff for tensile fracture (< 0).
VCR	Volumetric crushing option: EQ.0.0: on, EQ.1.0: loading and unloading paths are the same.
REF	Use reference geometry to initialize the pressure. The reference geometry is defined by the keyword:*INITIAL_FOAM_REFERENCE_GEOMETRY. This option does not initialize the deviatoric stress state. EQ.0.0: off, EQ.1.0: on.

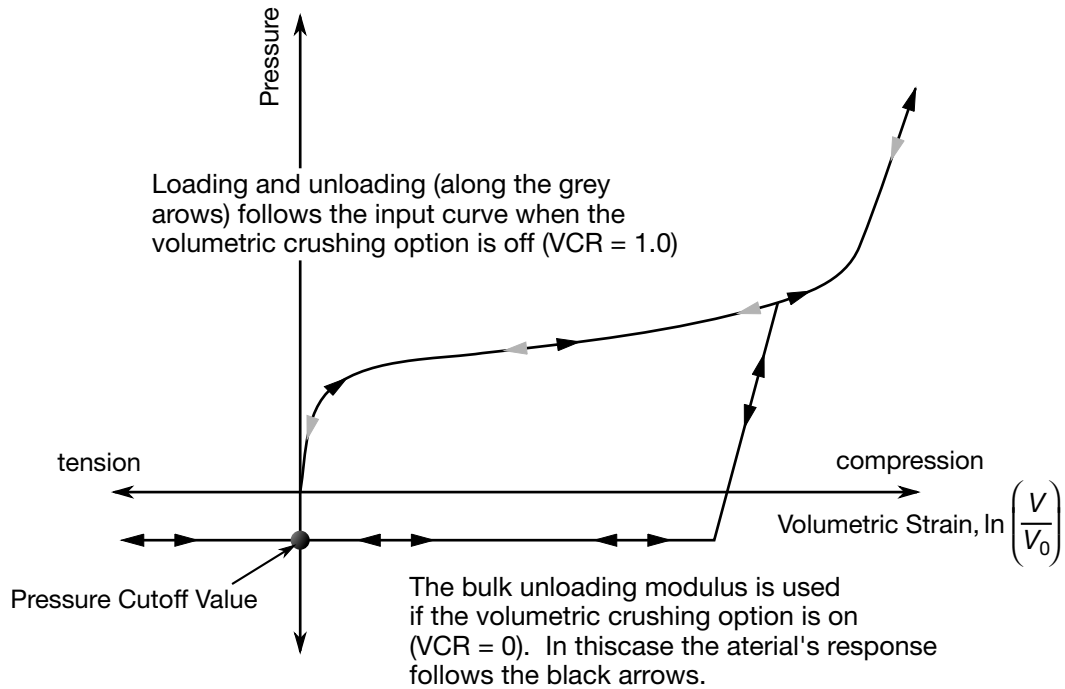

Figure 2-7. Pressure versus volumetric strain curve for soil and crushable foam model. The volumetric strain is given by the natural logarithm of the relative volume, V.

VARIABLE	DESCRIPTION
LCID	Load curve ID for compressive pressure (ordinate) as a function of volumetric strain (abscissa). If LCID is defined, then the curve is used instead of the input for EPS1..., and P1.... It makes no difference whether the values of volumetric strain in the curve are input as positive or negative since internally, a negative sign is applied to the absolute value of each abscissa entry. The response is extended to being temperature dependent if LCID refers to a table.
EPS1, ...	Volumetric strain values in pressure vs. volumetric strain curve (see Remarks below). A maximum of 10 values including 0.0 are allowed and a minimum of 2 values are necessary. If EPS1 is not 0.0 then a point (0.0,0.0) will be automatically generated and a maximum of nine values may be input.
P1, P2, ..., PN	Pressures corresponding to volumetric strain values given on Cards 3 and 4.

Remarks:

Pressure is positive in compression. Volumetric strain is given by the natural log of the relative volume and is negative in compression. Relative volume is a ratio of the current

volume to the initial volume at the start of the calculation. The tabulated data should be given in order of increasing compression. If the pressure drops below the cutoff value specified, it is reset to that value. For a detailed description we refer to Kreig [1972].

The deviatoric perfectly plastic yield function, ϕ , is described in terms of the second invariant J_2 ,

$$J_2 = \frac{1}{2} s_{ij}s_{ij},$$

pressure, p , and constants a_0 , a_1 , and a_2 as:

$$\phi = J_2 - [a_0 + a_1p + a_2p^2].$$

On the yield surface $J_2 = \frac{1}{3} \sigma_y^2$ where σ_y is the uniaxial yield stress, i.e.,

$$\sigma_y = [3(a_0 + a_1p + a_2p^2)]^{1/2}$$

there is no strain hardening on this surface.

To eliminate the pressure dependence of the yield strength, set:

$$a_1 = a_2 = 0 \quad \text{and} \quad a_0 = \frac{1}{3} \sigma_y^2.$$

This approach is useful when a von Mises type elastic-plastic model is desired for use with the tabulated volumetric data.

The history variable labeled as "plastic strain" by LS-PrePost is actually $\ln(V/V_0)$ in the case of *MAT_SOIL_AND_FOAM.

***MAT_VISCOELASTIC**

This is Material Type 6. This model allows the modeling of viscoelastic behavior for beams (Hughes-Liu), shells, and solids. Also see *MAT_GENERAL_VISCOELASTIC for a more general formulation.

Card 1	1	2	3	4	5	6	7	8
Variable	MID	RO	BULK	G0	GI	BETA		
Type	A8	F	F	F	F	F		

VARIABLE	DESCRIPTION
MID	Material identification. A unique number or label not exceeding 8 characters must be specified.
RO	Mass density
BULK	Elastic bulk modulus. LT.0.0: BULK is load curve of bulk modulus as a function of temperature.
G0	Short-time shear modulus, see equations below. LT.0.0: G0 is load curve of short-time shear modulus as a function of temperature.
GI	Long-time (infinite) shear modulus, G_{∞} . LT.0.0: GI is load curve of long-time shear modulus as a function of temperature.
BETA	Decay constant. LT.0.0: BETA is load curve of decay constant as a function of temperature.

Remarks:

The shear relaxation behavior is described by [Hermann and Peterson, 1968]:

$$G(t) = G_{\infty} + (G_0 - G_{\infty})\exp(-\beta t)$$

A Jaumann rate formulation is used

$$\overset{\nabla}{\sigma}'_{ij} = 2 \int_0^t G(t - \tau) D'_{ij}(\tau) d\tau$$

where the prime denotes the deviatoric part of the stress rate, $\overset{\nabla}{\sigma}'_{ij}$, and the strain rate, D_{ij} .

***MAT_BLATZKO_RUBBER**

This is Material Type 7. This one parameter material allows the modeling of nearly incompressible continuum rubber. The Poisson's ratio is fixed to 0.463.

Card 1	1	2	3	4	5	6	7	8
Variable	MID	RO	G	REF				
Type	A8	F	F	F				

VARIABLE**DESCRIPTION**

MID	Material identification. A unique number or label not exceeding 8 characters must be specified.
RO	Mass density.
G	Shear modulus.
REF	Use reference geometry to initialize the stress tensor. The reference geometry is defined by the keyword:*INITIAL_FOAM_REFERENCE_GEOMETRY (see there for more details). EQ.0.0: off, EQ.1.0: on.

Remarks:

The second Piola-Kirchhoff stress is computed as

$$S_{ij} = G \left[\frac{1}{V} C_{ij} - V^{-\left(\frac{1}{1-2\nu}\right)} \delta_{ij} \right]$$

where V is the relative volume defined as being the ratio of the current volume to the initial volume, C_{ij} is the right Cauchy-Green strain tensor, and ν is Poisson's ratio, which is set to .463 internally. This stress measure is transformed to the Cauchy stress, σ_{ij} , according to the relationship

$$\sigma_{ij} = V^{-1} F_{ik} F_{jl} S_{lk}$$

where F_{ij} is the deformation gradient tensor. Also see Blatz and Ko [1962].

***MAT_HIGH_EXPLOSIVE_BURN**

This is Material Type 8. It allows the modeling of the detonation of a high explosive. In addition an equation of state must be defined. See Wilkins [1969] and Giroux [1973].

Card 1	1	2	3	4	5	6	7	8
Variable	MID	RO	D	PCJ	BETA	K	G	SIGY
Type	A8	F	F	F	F	F	F	F

VARIABLE**DESCRIPTION**

MID	Material identification. A unique number or label not exceeding 8 characters must be specified.
RO	Mass density.
D	Detonation velocity.
PCJ	Chapman-Jouget pressure.
BETA	Beta burn flag, BETA (see comments below): EQ.0.0: beta + programmed burn, EQ.1.0: beta burn only, EQ.2.0: programmed burn only.
K	Bulk modulus (BETA = 2.0 only).
G	Shear modulus (BETA = 2.0 only).
SIGY	σ_y , yield stress (BETA = 2.0 only).

Remarks:

Burn fractions, F , which multiply the equations of states for high explosives, control the release of chemical energy for simulating detonations. At any time, the pressure in a high explosive element is given by:

$$p = Fp_{\text{eos}}(V, E)$$

where p_{eos} is the pressure from the equation of state (either types 2, 3, or 14), V is the relative volume, and E is the internal energy density per unit initial volume.

In the initialization phase, a lighting time t_l is computed for each element by dividing the distance from the detonation point to the center of the element by the detonation velocity D . If multiple detonation points are defined, the closest detonation point determines t_l . The burn fraction F is taken as the maximum

$$F = \max(F_1, F_2)$$

Where

$$F_1 = \begin{cases} \frac{2(t - t_l)DA_{e_{\max}}}{3v_e} & \text{if } t > t_l \\ 0 & \text{if } t \leq t_l \end{cases}$$

$$F_2 = \beta = \frac{1 - V}{1 - V_{CJ}}$$

where V_{CJ} is the Chapman-Jouguet relative volume and t is current time. If F exceeds 1, it is reset to 1. This calculation of the burn fraction usually requires several time steps for F to reach unity, thereby spreading the burn front over several elements. After reaching unity, F is held constant. This burn fraction calculation is based on work by Wilkins [1964] and is also discussed by Giroux [1973].

If the beta burn option is used, $BETA = 1.0$, any volumetric compression will cause detonation and

$$F = F_2$$

and F_1 is not computed.

If programmed burn is used, $BETA = 2.0$, the explosive model will behave as an elastic perfectly plastic material if the bulk modulus, shear modulus, and yield stress are defined. Therefore, with this option the explosive material can compress without causing detonation.

As an option, the high explosive material can behave as an elastic perfectly-plastic solid prior to detonation. In this case we update the stress tensor, to an elastic trial stress, $*s_{ij}^{n+1}$,

$$*s_{ij}^{n+1} = s_{ij}^n + s_{ip}\Omega_{pj} + s_{jp}\Omega_{pi} + 2G\varepsilon'_{ij}dt$$

where G is the shear modulus, and ε'_{ij} is the deviatoric strain rate. The von Mises yield condition is given by:

$$\phi = J_2 - \frac{\sigma_y^2}{3}$$

where the second stress invariant, J_2 , is defined in terms of the deviatoric stress components as

$$J_2 = \frac{1}{2}s_{ij}s_{ij}$$

and the yield stress is σ_y . If yielding has occurred, i.e., $\varphi > 0$, the deviatoric trial stress is scaled to obtain the final deviatoric stress at time $n+1$:

$$s_{ij}^{n+1} = \frac{\sigma_y}{\sqrt{3}J_2} * s_{ij}^{n+1}$$

If $\varphi \leq 0$, then

$$s_{ij}^{n+1} = * s_{ij}^{n+1}$$

Before detonation pressure is given by the expression

$$p^{n+1} = K \left(\frac{1}{V^{n+1}} - 1 \right)$$

where K is the bulk modulus. Once the explosive material detonates:

$$s_{ij}^{n+1} = 0$$

and the material behaves like a gas.

***MAT_NULL**

This is Material Type 9.

In the case of solids and thick shells, this material allows equations of state to be considered without computing deviatoric stresses. Optionally, a viscosity can be defined. Also, erosion in tension and compression is possible.

Beams and shells that use this material type are completely bypassed in the element processing; however, the mass of the null beam or shell elements is computed and added to the nodal points which define the connectivity. The mass of null beams is ignored if the value of the density is less than 1.e-11. The Young's modulus and Poisson's ratio are used only for setting the contact stiffness, and it is recommended that reasonable values be input. The variables PC, MU, TEROD, and EDROD do not apply to beams and shells. Historically, null beams and/or null shells have been used as an aid in modeling of contact but this practice is now seldom needed.

Card 1	1	2	3	4	5	6	7	8
Variable	MID	RO	PC	MU	TEROD	CEROD	YM	PR
Type	A8	F	F	F	F	F	F	F
Defaults	none	none	0.0	0.0	0.0	0.0	0.0	0.0

VARIABLE**DESCRIPTION**

MID	Material identification. A unique number or label not exceeding 8 characters must be specified.
RO	Mass density
PC	Pressure cutoff (≤ 0.0). See Remark 4.
MU	Dynamic viscosity μ (optional). See Remark 1.
TEROD	Relative volume, $\frac{V}{V_0}$, for erosion in tension. Typically, use values greater than unity. If zero, erosion in tension is inactive.
CEROD	Relative volume, $\frac{V}{V_0}$, for erosion in compression. Typically, use values less than unity. If zero, erosion in compression is inactive.
YM	Young's modulus (used for null beams and shells only)

VARIABLE	DESCRIPTION
PR	Poisson's ratio (used for null beams and shells only)

Remarks:

These remarks apply to solids and thick shells only.

1. When used with solids or thick shells, this material must be used with an equation-of-state. Pressure cutoff is negative in tension. A (deviatoric) viscous stress of the form

$$\sigma'_{ij} = 2\mu\dot{\epsilon}'_{ij}$$

$$\left[\frac{N}{m^2} \right] \sim \left[\frac{N}{m^2} s \right] \left[\frac{1}{s} \right]$$

is computed for nonzero μ where $\dot{\epsilon}'_{ij}$ is the deviatoric strain rate. μ is the dynamic viscosity. For example, in SI unit system, μ may have a unit of [Pa*s].

2. Null material has no shear stiffness (except from viscosity) and hourglass control must be used with great care. In some applications, the default hourglass coefficient may lead to significant energy losses. In general for fluid, the hourglass coefficient QM should be small (in the range 1.0E-6 to 1.0E-4) and the hourglass type IHQ should be set to 1 (default).
3. The Null material has no yield strength and behaves in a fluid-like manner.
4. The cut-off pressure, PC, must be defined to allow for a material to “numerically” cavitate. In other words, when a material undergoes dilatation above certain magnitude, it should no longer be able to resist this dilatation. Since dilatation stress or pressure is negative, setting PC limit to a very small negative number would allow for the material to cavitate once the pressure in the material goes below this negative value.

***MAT_ELASTIC_PLASTIC_HYDRO_{OPTION}**

This is Material Type 10. This material allows the modeling of an elastic-plastic hydrodynamic material and requires an equation-of-state (*EOS).

Available options include:

<BLANK>

SPALL

STOCHASTIC

The keyword card can appear in two ways:

*MAT_ELASTIC_PLASTIC_HYDRO or MAT_010

*MAT_ELASTIC_PLASTIC_HYDRO_SPALL or MAT_010_SPALL

Card 1	1	2	3	4	5	6	7	8
Variable	MID	R0	G	SIGY	EH	PC	FS	CHARL
Type	A8	F	F	F	F	F	F	F
Default	none	none	none	0.0	0.0	-∞	0.0	0.0

Spall Card. Additional card for SPALL keyword option.

Optional	1	2	3	4	5	6	7	8
Variable	A1	A2	SPALL					
Type	F	F	F					

Card 2	1	2	3	4	5	6	7	8
Variable	EPS1	EPS2	EPS3	EPS4	EPS5	EPS6	EPS7	EPS8
Type	F	F	F	F	F	F	F	F

Card 3	1	2	3	4	5	6	7	8
Variable	EPS9	EPS10	EPS11	EPS12	EPS13	EPS14	EPS15	EPS16
Type	F	F	F	F	F	F	F	F

Card 4	1	2	3	4	5	6	7	8
Variable	ES1	ES2	ES3	ES4	ES5	ES6	ES7	ES8
Type	F	F	F	F	F	F	F	F

Card 5	1	2	3	4	5	6	7	8
Variable	ES9	ES10	ES11	ES12	ES13	ES14	ES15	ES16
Type	F	F	F	F	F	F	F	F

VARIABLE

DESCRIPTION

- MID Material identification. A unique number or label not exceeding 8 characters must be specified.
- RO Mass density.
- G Shear modulus.
- SIGY Yield stress, see comment below.
- EH Plastic hardening modulus, see definition below.
- PC Pressure cutoff (≤ 0.0). If zero, a cutoff of $-\infty$ is assumed.
- FS Effective plastic strain at which erosion occurs.

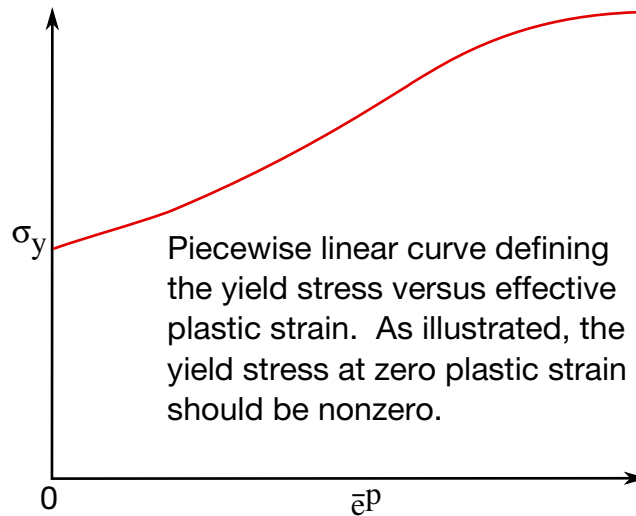

Figure 2-8. Effective stress versus effective plastic strain curve. See EPS and ES input.

VARIABLE	DESCRIPTION
CHARL	Characteristic element thickness for deletion. This applies to 2D solid elements that lie on a boundary of a part. If the boundary element thins down due to stretching or compression, and if it thins to a value less than CHARL, the element will be deleted. The primary application of this option is to predict the break-up of axisymmetric shaped charge jets.
A1	Linear pressure hardening coefficient.
A2	Quadratic pressure hardening coefficient.
SPALL	Spall type: EQ.0.0: default set to "1.0", EQ.1.0: tensile pressure is limited by PC, i.e., p is always \geq PC, EQ.2.0: if $\sigma_{max} \geq -PC$ element spalls and tension, $p < 0$, is never allowed, EQ.3.0: $p < PC$ element spalls and tension, $p < 0$, is never allowed.
EPS	Effective plastic strain (True). Define up to 16 values. Care must be taken that the full range of strains expected in the analysis is covered. Linear extrapolation is used if the strain values exceed the maximum input value.
ES	Effective stress. Define up to 16 values.

Remarks:

If ES and EPS are undefined, the yield stress and plastic hardening modulus are taken from SIGY and EH. In this case, the bilinear stress-strain curve shown in [2-8](#). is obtained with hardening parameter, $\beta = 1$. The yield strength is calculated as

$$\sigma_y = \sigma_0 + E_h \bar{\epsilon}^p + (a_1 + p a_2) \max[p, 0]$$

The quantity E_h is the plastic hardening modulus defined in terms of Young's modulus, E , and the tangent modulus, E_t , as follows

$$E_h = \frac{E_t E}{E - E_t}$$

and p is the pressure taken as positive in compression.

If ES and EPS are specified, a curve like that shown in [2-8](#). may be defined. Effective stress is defined in terms of the deviatoric stress tensor, s_{ij} , as:

$$\bar{\sigma} = \left(\frac{3}{2} s_{ij} s_{ij} \right)^{1/2}$$

and effective plastic strain by:

$$\bar{\epsilon}^p = \int_0^t \left(\frac{2}{3} D_{ij}^p D_{ij}^p \right)^{1/2} dt,$$

where t denotes time and D_{ij}^p is the plastic component of the rate of deformation tensor. In this case the plastic hardening modulus on Card 1 is ignored and the yield stress is given as

$$\sigma_y = f(\bar{\epsilon}^p),$$

where the value for $f(\bar{\epsilon}^p)$ is found by interpolation from the data curve.

A choice of three spall models is offered to represent material splitting, cracking, and failure under tensile loads. The pressure limit model, SPALL = 1, limits the hydrostatic tension to the specified value, p_{cut} . If pressures more tensile than this limit are calculated, the pressure is reset to p_{cut} . This option is not strictly a spall model, since the deviatoric stresses are unaffected by the pressure reaching the tensile cutoff, and the pressure cutoff value, p_{cut} , remains unchanged throughout the analysis. The maximum principal stress spall model, SPALL = 2, detects spall if the maximum principal stress, σ_{max} , exceeds the limiting value $-p_{cut}$. Note that the negative sign is required because p_{cut} is measured positive in compression, while σ_{max} is positive in tension. Once spall is detected with this model, the deviatoric stresses are reset to zero, and no hydrostatic tension ($p < 0$) is permitted. If tensile pressures are calculated, they are reset to 0 in the spalled material. Thus, the spalled material behaves as a rubble or incohesive material. The hydrostatic tension spall model, SPALL = 3, detects spall if the pressure becomes more tensile than the specified

limit, p_{cut} . Once spall is detected the deviatoric stresses are reset to zero, and nonzero values of pressure are required to be compressive (positive). If hydrostatic tension ($p < 0$) is subsequently calculated, the pressure is reset to 0 for that element.

This model is applicable to a wide range of materials, including those with pressure-dependent yield behavior. The use of 16 points in the yield stress versus effective plastic strain curve allows complex post-yield hardening behavior to be accurately represented. In addition, the incorporation of an equation of state permits accurate modeling of a variety of different materials. The spall model options permit incorporation of material failure, fracture, and disintegration effects under tensile loads.

The STOCHASTIC option allows spatially varying yield and failure behavior. See *DEFINE_STOCHASTIC_VARIATION for additional information.

***MAT_STEINBERG**

This is Material Type 11. This material is available for modeling materials deforming at very high strain rates ($> 10^5$) and can be used with solid elements. The yield strength is a function of temperature and pressure. An equation of state determines the pressure.

Card 1	1	2	3	4	5	6	7	8
Variable	MID	RO	G0	SIG0	BETA	N	GAMA	SIGM
Type	A8	F	F	F	F	F	F	F

Card 2	1	2	3	4	5	6	7	8
Variable	B	BP	H	F	A	TMO	GAMO	SA
Type	F	F	F	F	F	F	F	F

Card 3	1	2	3	4	5	6	7	8
Variable	PC	SPALL	RP	FLAG	MMN	MMX	ECO	EC1
Type	F	F	F	F	F	F	F	F

Card 4	1	2	3	4	5	6	7	8
Variable	EC2	EC3	EC4	EC5	EC6	EC7	EC8	EC9
Type	F	F	F	F	F	F	F	F

VARIABLE**DESCRIPTION**

MID	Material identification. A unique number or label not exceeding 8 characters must be specified.
RO	Mass density.
G0	Basic shear modulus.

VARIABLE	DESCRIPTION
SIGO	σ_o , see defining equations.
BETA	β , see defining equations.
N	n, see defining equations.
GAMA	γ_i , initial plastic strain, see defining equations.
SIGM	σ_m , see defining equations.
B	b, see defining equations.
BP	b', see defining equations.
H	h, see defining equations.
F	f, see defining equations.
A	Atomic weight (if = 0.0, R' must be defined).
TMO	T_{m0} , see defining equations.
GAMO	γ_o , see defining equations.
SA	a, see defining equations.
PC	Pressure cutoff (default = -1.e+30)
SPALL	Spall type: EQ.0.0: default set to "2.0", EQ.1.0: $p \geq PC$, EQ.2.0: if $\sigma_{max} \geq -PC$ element spalls and tension, $p < 0$, is never allowed, EQ.3.0: $p < PC$ element spalls and tension, $p < 0$, is never allowed.
RP	R'. If $R' \neq 0.0$, A is not defined.
FLAG	Set to 1.0 for μ coefficients for the cold compression energy fit. Default is η .
MMN	μ_{min} or η_{min} . Optional μ or η minimum value.
MMX	μ_{max} or η_{max} . Optional μ or η maximum value.

VARIABLE	DESCRIPTION
EC0, ..., EC9	Cold compression energy coefficients (optional).

Remarks:

Users who have an interest in this model are encouraged to study the paper by Steinberg and Guinan which provides the theoretical basis. Another useful reference is the KOVEC user's manual.

In terms of the foregoing input parameters, we define the shear modulus, G , before the material melts as:

$$G = G_0 \left[1 + bpV^{1/3} - h \left(\frac{E_i - E_c}{3R'} - 300 \right) \right] e^{\frac{-fE_i}{E_m - E_i}}$$

where p is the pressure, V is the relative volume, E_c is the cold compression energy:

$$E_c(x) = \int_0^x p dx - \frac{900R' \exp(ax)}{(1-x)^{2(\gamma_0 - a - 1/2)'}}$$

$$x = 1 - V,$$

and E_m is the melting energy:

$$E_m(x) = E_c(x) + 3R'T_m(x)$$

which is in terms of the melting temperature $T_m(x)$:

$$T_m(x) = \frac{T_{m0} \exp(2ax)}{V^{2(\gamma_0 - a - 1/3)'}}$$

and the melting temperature at $\rho = \rho_0$, T_{m0} .

In the above equation R' is defined by

$$R' = \frac{R\rho}{A}$$

where R is the gas constant and A is the atomic weight. If R' is not defined, LS-DYNA computes it with R in the cm-gram-microsecond system of units.

The yield strength σ_y is given by:

$$\sigma_y = \sigma'_0 \left[1 + b'pV^{1/3} - h \left(\frac{E_i - E_c}{3R'} - 300 \right) \right] e^{\frac{-fE_i}{E_m - E_i}}$$

if E_m exceeds E_i . Here, σ'_0 is given by:

$$\sigma'_0 = \sigma_0 [1 + \beta(\gamma_i + \bar{\epsilon}^p)]^n$$

where σ_0 is the initial yield stress and γ_i is the initial plastic strain. If the work-hardened yield stress σ'_0 exceeds σ_m , σ'_0 is set equal to σ_m . After the materials melt, σ_y and G are set to one half their initial value.

If the coefficients EC0, ..., EC9 are not defined above, LS-DYNA will fit the cold compression energy to a ten term polynomial expansion either as a function of μ or η depending on the input variable, FLAG, as:

$$E_c(\eta^i) = \sum_{i=0}^9 EC_i \eta^i$$

$$E_c(\mu^i) = \sum_{i=0}^9 EC_i \mu^i$$

where EC_i is the i th coefficient and:

$$\eta = \frac{\rho}{\rho_o}$$

$$\mu = \frac{\rho}{\rho_o} - 1$$

A linear least squares method is used to perform the fit.

A choice of three spall models is offered to represent material splitting, cracking, and failure under tensile loads. The pressure limit model, SPALL = 1, limits the hydrostatic tension to the specified value, p_{cut} . If pressures more tensile than this limit are calculated, the pressure is reset to p_{cut} . This option is not strictly a spall model, since the deviatoric stresses are unaffected by the pressure reaching the tensile cutoff, and the pressure cutoff value, p_{cut} , remains unchanged throughout the analysis. The maximum principal stress spall model, SPALL = 2, detects spall if the maximum principal stress, σ_{max} , exceeds the limiting value $-p_{cut}$. Note that the negative sign is required because p_{cut} is measured positive in compression, while σ_{max} is positive in tension. Once spall is detected with this model, the deviatoric stresses are reset to zero, and no hydrostatic tension ($p < 0$) is permitted. If tensile pressures are calculated, they are reset to 0 in the spalled material. Thus, the spalled material behaves as a rubble or incohesive material. The hydrostatic tension spall model, SPALL = 3, detects spall if the pressure becomes more tensile than the specified limit, p_{cut} . Once spall is detected the deviatoric stresses are reset to zero, and nonzero values of pressure are required to be compressive (positive). If hydrostatic tension ($p < 0$) is subsequently calculated, the pressure is reset to 0 for that element.

This model is applicable to a wide range of materials, including those with pressure-dependent yield behavior. In addition, the incorporation of an equation of state permits accurate modeling of a variety of different materials. The spall model options permit incorporation of material failure, fracture, and disintegration effects under tensile loads.

***MAT_STEINBERG_LUND**

This is Material Type 11. This material is a modification of the Steinberg model above to include the rate model of Steinberg and Lund [1989]. An equation of state determines the pressure.

The keyword cards can appear in two ways:

*MAT_STEINBERG_LUND or MAT_011_LUND

Card 1	1	2	3	4	5	6	7	8
Variable	MID	RO	G0	SIG0	BETA	N	GAMA	SIGM
Type	A8	F	F	F	F	F	F	F

Card 2	1	2	3	4	5	6	7	8
Variable	B	BP	H	F	A	TMO	GAMO	SA
Type	F	F	F	F	F	F	F	F

Card 3	1	2	3	4	5	6	7	8
Variable	PC	SPALL	RP	FLAG	MMN	MMX	ECO	EC1
Type	F	F	F	F	F	F	F	F

Card 4	1	2	3	4	5	6	7	8
Variable	EC2	EC3	EC4	EC5	EC6	EC7	EC8	EC9
Type	F	F	F	F	F	F	F	F

Card 5	1	2	3	4	5	6	7	8
Variable	UK	C1	C2	YP	YA	YM		
Type	F	F	F	F	F	F		

VARIABLE**DESCRIPTION**

MID	Material identification. A unique number or label not exceeding 8 characters must be specified.
RO	Mass density.
G0	Basic shear modulus.
SIGO	σ_0 , see defining equations.
BETA	β , see defining equations.
N	n , see defining equations.
GAMA	γ_i , initial plastic strain, see defining equations.
SIGM	σ_m , see defining equations.
B	b , see defining equations.
BP	b' , see defining equations.
H	h , see defining equations.
F	f , see defining equations.
A	Atomic weight (if = 0.0, R' must be defined).
TMO	T_{m0} , see defining equations.
GAMO	γ_0 , see defining equations.
SA	a , see defining equations.
PC	p_{cut} or $-\sigma_f$ (default = $-1.e+30$)

VARIABLE	DESCRIPTION
SPALL	Spall type: EQ.0.0: default set to "2.0", EQ.1.0: $p \geq p_{\min}$, EQ.2.0: if $\sigma_{\max} \geq -p_{\min}$ element spalls and tension, $p < 0$, is never allowed, EQ.3.0: $p < -p_{\min}$ element spalls and tension, $p < 0$, is never allowed.
RP	R'. If R'≠0.0, A is not defined.
FLAG	Set to 1.0 for μ coefficients for the cold compression energy fit. Default is η .
MMN	μ_{\min} or η_{\min} . Optional μ or η minimum value.
MMX	μ_{\max} or η_{\max} . Optional μ or η maximum value.
EC0, ..., EC9	Cold compression energy coefficients (optional).
UK	Activation energy for rate dependent model.
C1	Exponent prefactor in rate dependent model.
C2	Coefficient of drag term in rate dependent model.
YP	Peierls stress for rate dependent model.
YA	A thermal yield stress for rate dependent model.
YMAX	Work hardening maximum for rate model.

Remarks:

This model is similar in theory to the *MAT_STEINBERG above but with the addition of rate effects. When rate effects are included, the yield stress is given by:

$$\sigma_y = \{Y_T(\dot{\epsilon}_p, T) + Y_{Af}(\epsilon_p)\} \frac{G(p, T)}{G_0}$$

There are two imposed limits on the yield stress. The first is on the thermal yield stress:

$$Y_{Af}(\epsilon_p) = Y_A [1 + \beta(\gamma_i + \epsilon^p)]^n \leq Y_{\max}$$

and the second is on the thermal part:

$$Y_T \leq Y_P$$

R' is the heat capacity per unit volume. Most handbooks give the heat capacity per unit mass or per mole. To obtain R', multiply the heat capacity per unit mass by the initial density, and to obtain R' from the heat capacity per mole, divide it by the mass per mole and then multiply the result by the initial density. The mass per mole in grams equals the atomic weight.

For example, the heat capacity per mole for aluminum is 24.2 J/mole/K, the density is 2.70 g/cc, and the atomic weight is 13. The heat capacity per cubic centimeter is therefore (24.2 J/mole/K) / (13g/mole) × (2.70g/cc)= 5.026 J/cc/K. To convert it to J/m³/K, multiply the result by 10⁶ cc/m³ to obtain a final heat capacity of 5.026e6 J/m³/K.

*MAT_ISOTROPIC_ELASTIC_PLASTIC

This is Material Type 12. This is a very low cost isotropic plasticity model for three-dimensional solids. In the plane stress implementation for shell elements, a one-step radial return approach is used to scale the Cauchy stress tensor to if the state of stress exceeds the yield surface. This approach to plasticity leads to inaccurate shell thickness updates and stresses after yielding. This is the only model in LS-DYNA for plane stress that does not default to an iterative approach.

Card	1	2	3	4	5	6	7	8
Variable	MID	RO	G	SIGY	ETAN	BULK		
Type	A8	F	F	F	F	F		

VARIABLE	DESCRIPTION
MID	Material identification. A unique number or label not exceeding 8 characters must be specified.
RO	Mass density.
G	Shear modulus.
SIGY	Yield stress.
ETAN	Plastic hardening modulus.
BULK	Bulk modulus, K.

Remarks:

Here the pressure is integrated in time

$$\dot{p} = -K\dot{\epsilon}_{ii}$$

where $\dot{\epsilon}_{ii}$ is the volumetric strain rate.

***MAT_ISOTROPIC_ELASTIC_FAILURE**

This is Material Type 13. This is a non-iterative plasticity with simple plastic strain failure model.

Card 1	1	2	3	4	5	6	7	8
Variable	MID	RO	G	SIGY	ETAN	BULK		
Type	A8	F	F	F	F	F		
Default	none	none	none	none	0.0	none		

Card 2	1	2	3	4	5	6	7	8
Variable	EPF	PRF	REM	TREM				
Type	F	F	F	F				
Default	none	0.0	0.0	0.0				

VARIABLE**DESCRIPTION**

MID	Material identification. A unique number or label not exceeding 8 characters must be specified.
RO	Mass density.
G	Shear modulus.
SIGY	Yield stress.
ETAN	Plastic hardening modulus.
BULK	Bulk modulus.
EPF	Plastic failure strain.
PRF	Failure pressure (≤ 0.0).

VARIABLE	DESCRIPTION
REM	Element erosion option: EQ.0.0: failed element eroded after failure, NE.0.0: element is kept, no removal except by Δt below.
TREM	Δt for element removal: EQ.0.0: Δt is not considered (default), GT.0.0: element eroded if element time step size falls below Δt .

Remarks:

When the effective plastic strain reaches the failure strain or when the pressure reaches the failure pressure, the element loses its ability to carry tension and the deviatoric stresses are set to zero, i.e., the material behaves like a fluid. If Δt for element removal is defined the element removal option is ignored.

The element erosion option based on Δt must be used cautiously with the contact options. Nodes to surface contact is recommended with all nodes of the eroded brick elements included in the node list. As the elements are eroded the mass remains and continues to interact with the master surface.

***MAT_SOIL_AND_FOAM_FAILURE**

This is Material Type 14. The input for this model is the same as for *MATERIAL_SOIL_-AND_FOAM (Type 5); however, when the pressure reaches the failure pressure, the element loses its ability to carry tension. It should be used only in situations when soils and foams are confined within a structure or when geometric boundaries are present.

***MAT_JOHNSON_COOK_{OPTION}**

Available options include:

<BLANK>

STOCHASTIC

This is Material Type 15. The Johnson/Cook strain and temperature sensitive plasticity is sometimes used for problems where the strain rates vary over a large range and adiabatic temperature increases due to plastic heating cause material softening. When used with solid elements this model requires an equation-of-state. If thermal effects and damage are unimportant, the much less expensive *MAT_SIMPLIFIED_JOHNSON_COOK model is recommended. The simplified model can be used with beam elements.

Card 1	1	2	3	4	5	6	7	8
Variable	MID	R0	G	E	PR	DTF	VP	RATEOP
Type	A8	F	F	F	F	F	F	F
Default	none	none	none	none	none	0.0	0.0	0.0

Card 2	1	2	3	4	5	6	7	8
Variable	A	B	N	C	M	TM	TR	EPS0
Type	F	F	F	F	F	F	F	F
Default	none	0.0	0.0	0.0	none	none	none	none

Card 3	1	2	3	4	5	6	7	8
Variable	CP	PC	SPALL	IT	D1	D2	D3	D4
Type	F	F	F	F	F	F	F	F
Default	none	0.0	2.0	0.0	0.0	0.0	0.0	0.0

Card 4	1	2	3	4	5	6	7	8
Variable	D5	C2/P	EROD	EFMIN	NUMINT			
Type	F	F	F	F	F			
Default	0.0	0.0	0.0	0.000001	0.			

VARIABLE**DESCRIPTION**

MID	Material identification. A unique number or label not exceeding 8 characters must be specified.
RO	Mass density
G	Shear modulus
E	Young's Modulus (shell elements only)
PR	Poisson's ratio (shell elements only)
DTF	Minimum time step size for automatic element deletion (shell elements). The element will be deleted when the solution time step size drops below DTF*TSSFAC where TSSFAC is the time step scale factor defined by *CONTROL_TIMESTEP.
VP	Formulation for rate effects: EQ.0.0: Scale yield stress (default), EQ.1.0: Viscoplastic formulation.

VARIABLE	DESCRIPTION
RATEOP	Form of strain-rate term. RATEOP is ignored if VP = 0. EQ.0.0: Log-Linear Johnson-Cook (default), EQ.1.0: Log-Quadratic Huh-Kang (2 parameters), EQ.2.0: Exponential Allen-Rule-Jones, EQ.3.0: Exponential Cowper-Symonds (2 parameters). EQ.4.0: Nonlinear rate coefficient (2 parameters).
A	See equations below.
B	See equations below.
N	See equations below.
C	See equations below.
M	See equations below.
TM	Melt temperature
TR	Room temperature
EPS0	Quasi-static threshold strain rate. Ideally, this value represents the highest strain rate for which no rate adjustment to the flow stress is needed, and is input in units of 1/model time units. For example, if strain rate effects on the flow stress first become apparent at strain rates greater than 1E-02 seconds ⁻¹ and the system of units for the model input is kg, mm, msec, then EPS0 should be set to 1E-05 [msec ⁻¹]
CP	Specific heat (superseded by heat capacity in *MAT_THERMAL_OPTION if a coupled thermal/structural analysis)
PC	Tensile failure stress or tensile pressure cutoff (PC < 0.0)

VARIABLE	DESCRIPTION
SPALL	Spall type: EQ.0.0: default set to "2.0", EQ.1.0: Tensile pressure is limited by PC, i.e., p is always \geq PC, EQ.2.0: $\sigma_{max} \geq -PC$ triggers shell element deletion and tensile stresses to be reset to zero in solid elements:Only compressive stresses are subsequently allowed in solids, EQ.3.0: $p < PC$ triggers shell element deletion and pressure to be reset to zero in solid elements:Tensile pressure is subsequently disallowed in solids.
IT	Plastic strain iteration option. This input applies to solid elements only since it is always necessary to iterate for the shell element plane stress condition. EQ.0.0: no iterations (default), EQ.1.0: accurate iterative solution for plastic strain:Much more expensive than default.
D1-D5	Failure parameters, see equations below. A negative input of D3 will be taken as its absolute value.
C2/P/n'	Optional strain-rate parameter for Huh-Kang (C2), Cowper-Symonds (P), and nonlinear rate coefficient (n') forms; see equations below.
EROD	Erosion Flag: EQ.0.0: default, element erosion allowed. NE.0.0: element does not erode; deviatoric stresses set to zero when element fails.
EFMIN	The lowerbound for calculated strain at fracture (see equation).

VARIABLE	DESCRIPTION
NUMINT	Number of through thickness integration points which must fail before the shell element is deleted. (If zero, all points must fail.) The default of all integration points is not recommended since elements undergoing large strain are often not deleted due to nodal fiber rotations which limit strains at active integration points after most points have failed. Better results are obtained if NUMINT is set to 1 or a number less than one half of the number of through thickness points. For example, if four through thickness points are used, NUMINT should not exceed 2, even for fully integrated shells which have 16 integration points.

Remarks:

Johnson and Cook express the flow stress as

$$\sigma_y = (A + B\bar{\epsilon}^n)(1 + c \ln \dot{\epsilon}^*)(1 - T^{*m})$$

Where,

A, B, C, N, and M = input constants

$\bar{\epsilon}^p$ = effective plastic strain

$$\dot{\epsilon}^* = \begin{cases} \frac{\dot{\epsilon}}{\text{EPSO}} & \text{for VP.EQ.0 (normalized effective total strain-rate)} \\ \frac{\dot{\epsilon}^p}{\text{EPSO}} & \text{for VP.EQ.1 (normalized effective plastic strain rate)} \end{cases}$$

$$T^* = \text{homologous temperature} = \frac{T - T_{\text{room}}}{T_{\text{melt}} - T_{\text{room}}}$$

The quantity $T - T_{\text{room}}$ is stored as extra history variable 5.

Constants for a variety of materials are provided in Johnson and Cook [1983]. A fully viscoplastic formulation is optional (VP) which incorporates the rate equations within the yield surface. An additional cost is incurred but the improvement is that results can be dramatic.

Due to nonlinearity in the dependence of flow stress on plastic strain, an accurate value of the flow stress requires iteration for the increment in plastic strain. However, by using a Taylor series expansion with linearization about the current time, we can solve for σ_y with sufficient accuracy to avoid iteration.

The strain at fracture is given by

$$\epsilon^f = \max([D_1 + D_2 \exp D_3 \sigma^*][1 + D_4 \ln \dot{\epsilon}^*][1 + D_5 T^*], \text{EFMIN})$$

where σ^* is the ratio of pressure divided by effective stress

$$\sigma^* = \frac{p}{\sigma_{eff}}$$

Fracture occurs when the damage parameter

$$D = \sum \frac{\Delta \bar{\epsilon}^p}{\epsilon^f}$$

reaches the value of 1. D is stored as extra history variable 4 in shell elements and extra history variable 6 in solid elements.

A choice of three spall models is offered to represent material splitting, cracking, and failure under tensile loads. The pressure limit model limits the minimum hydrostatic pressure to the specified value, $p \geq p_{min}$. If pressures more tensile than this limit are calculated, the pressure is reset to p_{min} . This option is not strictly a spall model since the deviatoric stresses are unaffected by the pressure reaching the tensile cutoff and the pressure cutoff value p_{min} remains unchanged throughout the analysis. The maximum principal stress spall model detects spall if the maximum principal stress, σ_{max} , exceeds the limiting value σ_p . Once spall in solids is detected with this model, the deviatoric stresses are reset to zero and no hydrostatic tension is permitted. If tensile pressures are calculated, they are reset to 0 in the spalled material. Thus, the spalled material behaves as rubble. The hydrostatic tension spall model detects spall if the pressure becomes more tensile than the specified limit, p_{min} . Once spall in solids is detected with this model, the deviatoric stresses are set to zero and the pressure is required to be compressive. If hydrostatic tension is calculated then the pressure is reset to 0 for that element.

In addition to the above failure criterion, this material model also supports a shell element deletion criterion based on the maximum stable time step size for the element, Δt_{max} . Generally, Δt_{max} goes down as the element becomes more distorted. To assure stability of time integration, the global LS-DYNA time step is the minimum of the Δt_{max} values calculated for all elements in the model. Using this option allows the selective deletion of elements whose time step Δt_{max} has fallen below the specified minimum time step, Δt_{crit} . Elements which are severely distorted often indicate that material has failed and supports little load, but these same elements may have very small time steps and therefore control the cost of the analysis. This option allows these highly distorted elements to be deleted from the calculation, and, therefore, the analysis can proceed at a larger time step, and, thus, at a reduced cost. Deleted elements do not carry any load, and are deleted from all applicable slide surface definitions. Clearly, this option must be judiciously used to obtain accurate results at a minimum cost.

Material type 15 is applicable to the high rate deformation of many materials including most metals. Unlike the Steinberg-Guinan model, the Johnson-Cook model remains valid down to lower strain rates and even into the quasistatic regime. Typical applications include explosive metal forming, ballistic penetration, and impact.

Optional Strain Rate Forms:

The standard Johnson-Cook strain rate term is linear in the logarithm of the strain rate:

$$1 + C \ln \dot{\epsilon}^*$$

Some additional data fitting capability can be obtained by using the quadratic form proposed by Huh & Kang [2002]:

$$1 + C \ln \dot{\epsilon}^* + C_2 (\ln \dot{\epsilon}^*)^2$$

Three additional exponential forms are available, one due to Allen, Rule & Jones [1997],

$$(\dot{\epsilon}^*)^c$$

the Cowper-Symonds-like [1958] form

$$1 + \left(\frac{\dot{\epsilon}_{eff}^p}{C} \right)^{\frac{1}{P}}$$

and the nonlinear rate coefficient,

$$1 + C (\dot{\epsilon}_{eff}^p)^{n'} \ln \dot{\epsilon}^*.$$

The four additional rate forms (RATEOP = 1,2, 3 or 4) are currently available for solid & shell elements but only when the viscoplastic rate option is active (VP = 1). If VP is set to zero, RATEOP is ignored. See Huh and Kang [2002], Allen, Rule, and Jones [1997], and Cowper and Symonds [1958].

The STOCHASTIC option allows spatially varying yield and failure behavior. See *DEFINE_STOCHASTIC_VARIATION for additional information.

***MAT_PSEUDO_TENSOR**

This is Material Type 16. This model has been used to analyze buried steel reinforced concrete structures subjected to impulsive loadings.

Card 1	1	2	3	4	5	6	7	8
Variable	MID	R0	G	PR				
Type	A8	F	F	F				
Default	none	none	none	none				

Card 2	1	2	3	4	5	6	7	8
Variable	SIGF	A0	A1	A2	A0F	A1F	B1	PER
Type	F	F	F	F	F	F	F	F
Default	0.0	0.0	0.0	0.0	0.0	0.0	0.0	0.0

Card 3	1	2	3	4	5	6	7	8
Variable	ER	PRR	SIGY	ETAN	LCP	LCR		
Type	F	F	F	F	F	F		
Default	0.0	0.0	none	0.0	none	none		

Card 4	1	2	3	4	5	6	7	8
Variable	X1	X2	X3	X4	X5	X6	X7	X8
Type	F	F	F	F	F	F	F	F
Default	none	none	none	none	none	none	none	none

Card 5	1	2	3	4	5	6	7	8
Variable	X9	X10	X11	X12	X13	X14	X15	X16
Type	F	F	F	F	F	F	F	F
Default	none	none	none	none	none	none	none	none

Card 6	1	2	3	4	5	6	7	8
Variable	YS1	YS2	YS3	YS4	YS5	YS6	YS7	YS8
Type	F	F	F	F	F	F	F	F
Default	none	none	none	none	none	none	none	none

Card 7	1	2	3	4	5	6	7	8
Variable	YS9	YS10	YS11	YS12	YS13	YS14	YS15	YS16
Type	F	F	F	F	F	F	F	F
Default	none	none	none	none	none	none	none	none

VARIABLE	DESCRIPTION
MID	Material identification. A unique number or label not exceeding 8 characters must be specified.
RO	Mass density.
G	Shear modulus.
PR	Poisson's ratio.
SIGF	Tensile cutoff (maximum principal stress for failure).
A0	Cohesion.
A1	Pressure hardening coefficient.
A2	Pressure hardening coefficient.
A0F	Cohesion for failed material.
A1F	Pressure hardening coefficient for failed material.
B1	Damage scaling factor (or exponent in Mode II.C).
PER	Percent reinforcement.
ER	Elastic modulus for reinforcement.
PRR	Poisson's ratio for reinforcement.
SIGY	Initial yield stress.
ETAN	Tangent modulus/plastic hardening modulus.
LCP	Load curve ID giving rate sensitivity for principal material, see *DEFINE_CURVE.
LCR	Load curve ID giving rate sensitivity for reinforcement, see *DEFINE_CURVE.
X_n	Effective plastic strain, damage, or pressure. See discussion below.
YS_n	Yield stress (Mode I) or scale factor (Mode II.B or II.C).

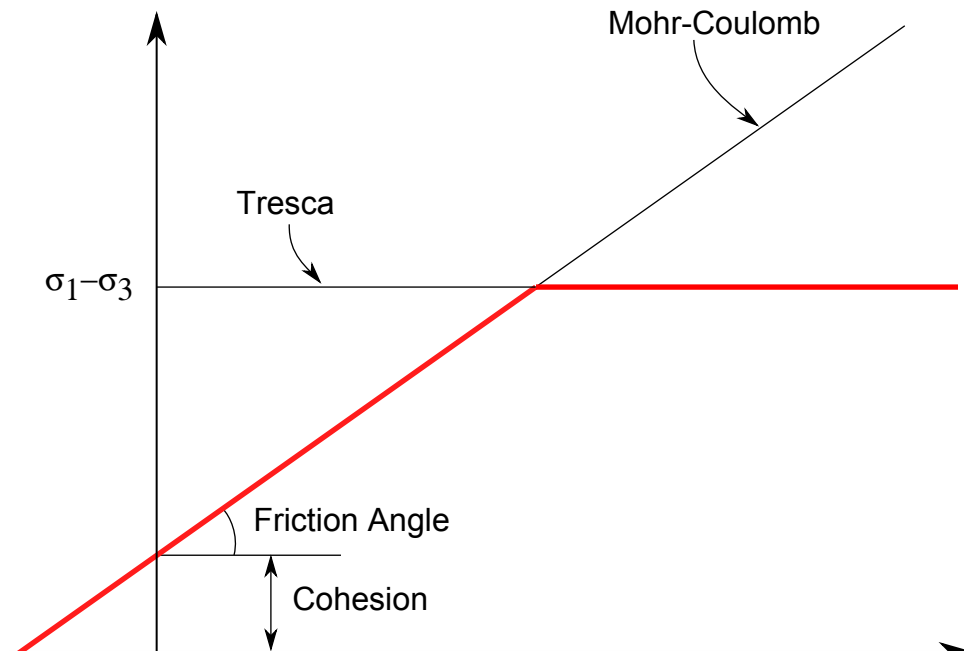

Figure 2-9. Mohr-Coulomb surface with a Tresca Limit.

Remarks:

This model can be used in two major modes - a simple tabular pressure-dependent yield surface, and a potentially complex model featuring two yield versus pressure functions with the means of migrating from one curve to the other. For both modes, load curve LCP is taken to be a strain rate multiplier for the yield strength. Note that this model must be used with equation-of-state type 8 or 9.

Response Mode I. Tabulated Yield Stress Versus Pressure

This model is well suited for implementing standard geologic models like the Mohr-Coulomb yield surface with a Tresca limit, as shown in [Figure 2-9](#). Examples of converting conventional triaxial compression data to this type of model are found in (Desai and Siriwardane, 1984). Note that under conventional triaxial compression conditions, the LS-DYNA input corresponds to an ordinate of $\sigma_1 - \sigma_3$ rather than the more widely used $\frac{\sigma_1 - \sigma_3}{2}$, where σ_1 is the maximum principal stress and σ_3 is the minimum principal stress.

This material combined with equation-of-state type 9 (saturated) has been used very successfully to model ground shocks and soil-structure interactions at pressures up to 100kbars (approximately 1.5×10^6 psi).

To invoke Mode I of this model, set a_0 , a_1 , a_2 , b_1 , a_{0f} , and a_{1f} to zero. The tabulated values of pressure should then be specified on cards 4 and 5, and the corresponding values of yield

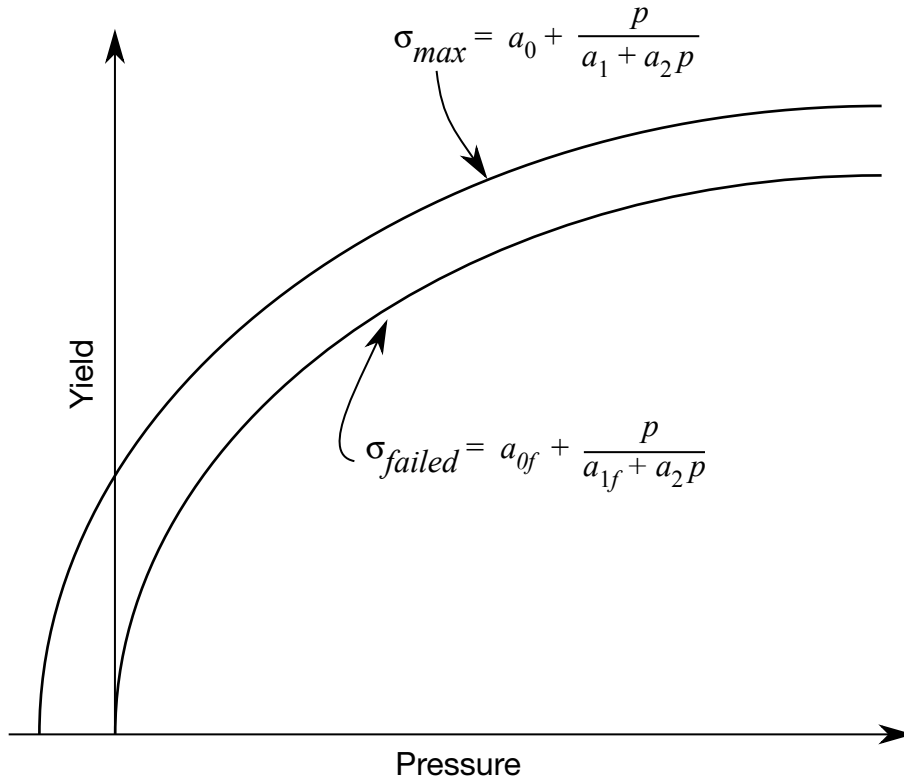

Figure 2-10. Two-curve concrete model with damage and failure

stress should be specified on cards 6 and 7. The parameters relating to reinforcement properties, initial yield stress, and tangent modulus are not used in this response mode, and should be set to zero.

Simple tensile failure

Note that a_{1f} is reset internally to 1/3 even though it is input as zero; this defines a failed material curve of slope $3p$, where p denotes pressure (positive in compression). In this case the yield strength is taken from the tabulated yield vs. pressure curve until the maximum principal stress (σ_1) in the element exceeds the tensile cut-off (σ_{cut}). For every time step that $\sigma_1 > \sigma_{cut}$ the yield strength is scaled back by a fraction of the distance between the two curves until after 20 time steps the yield strength is defined by the failed curve. The only way to inhibit this feature is to set σ_{cut} arbitrarily large.

Response Mode II. Two Curve Model with Damage and Failure

This approach uses two yield versus pressure curves of the form

$$\sigma_y = a_0 + \frac{p}{a_1 + a_2p}$$

The upper curve is best described as the maximum yield strength curve and the lower curve is the failed material curve. There are a variety of ways of moving between the two curves and each is discussed below.

MODE II. A: Simple tensile failure

Define a_0 , a_1 , a_2 , a_{0f} and a_{1f} , set b_1 to zero, and leave cards 4 through 7 blank. In this case the yield strength is taken from the maximum yield curve until the maximum principal stress (σ_1) in the element exceeds the tensile cut-off (σ_{cut}). For every time step that $\sigma_1 > \sigma_{cut}$ the yield strength is scaled back by a fraction of the distance between the two curves until after 20 time steps the yield strength is defined by the failure curve.

Mode II.B: Tensile failure plus plastic strain scaling

Define a_0 , a_1 , a_2 , a_{0f} and a_{1f} , set b_1 to zero, and use cards 4 through 7 to define a scale factor, η , versus effective plastic strain. LS-DYNA evaluates η at the current effective plastic strain and then calculated the yield stress as

$$\sigma_{yield} = \sigma_{failed} + \eta(\sigma_{max} - \sigma_{failed})$$

where σ_{max} and σ_{failed} are found as shown in [Figure 2-10](#). This yield strength is then subject to scaling for tensile failure as described above. This type of model allows the description of a strain hardening or softening material such as concrete.

Mode II.C: Tensile failure plus damage scaling

The change in yield stress as a function of plastic strain arises from the physical mechanisms such as internal cracking, and the extent of this cracking is affected by the hydrostatic pressure when the cracking occurs. This mechanism gives rise to the "confinement" effect on concrete behavior. To account for this phenomenon, a "damage" function was defined and incorporated. This damage function is given the form:

$$\lambda = \int_0^{\varepsilon^p} \left(1 + \frac{p}{\sigma_{cut}}\right)^{-b_1} d\varepsilon^p$$

Define a_0 , a_1 , a_2 , a_{0f} and a_{1f} , and b_1 . Cards 4 through 7 now give η as a function of λ and scale the yield stress as

$$\sigma_{yield} = \sigma_{failed} + \eta(\sigma_{max} - \sigma_{failed})$$

and then apply any tensile failure criteria.

Mode II Concrete Model Options

Material Type 16 Mode II provides for the automatic internal generation of a simple "generic" model from concrete if A0 is negative then SIGF is assumed to be the unconfined concrete compressive strength, f'_c and $-A0$ is assumed to be a conversion factor from LS-DYNA pressure units to psi. (For example, if the model stress units are MPa, A0 should be set to -145 .) In this case the parameter values generated internally are

$$\begin{aligned}
 f'_c &= \text{SIGF} & a_1 &= \frac{1}{3} & a_{0f} &= 0 \\
 \sigma_{cut} &= 1.7 \left(\frac{f'^2_c}{-A0} \right)^{\frac{1}{3}} & a_2 &= \frac{1}{3f'_c} & a_{1f} &= 0.385 \\
 a_0 &= \frac{f'_c}{4}
 \end{aligned}$$

Note that these a_{0f} and a_{1f} defaults will be overridden by non zero entries on Card 3. If plastic strain or damage scaling is desired, Cards 5 through 8 and b_1 should be specified in the input. When a_0 is input as a negative quantity, the equation-of-state can be given as 0 and a trilinear EOS Type 8 model will be automatically generated from the unconfined compressive strength and Poisson's ratio. The EOS 8 model is a simple pressure versus volumetric strain model with no internal energy terms, and should give reasonable results for pressures up to 5kbar (approximately 75,000 psi).

Mixture model

A reinforcement fraction, f_r , can be defined along with properties of the reinforcement material. The bulk modulus, shear modulus, and yield strength are then calculated from a simple mixture rule, i.e., for the bulk modulus the rule gives:

$$K = (1 - f_r)K_m + f_rK_r$$

where K_m and K_r are the bulk moduli for the geologic material and the reinforcement material, respectively. This feature should be used with caution. It gives an isotropic effect in the material instead of the true anisotropic material behavior. A reasonable approach would be to use the mixture elements only where the reinforcing exists and plain elements elsewhere. When the mixture model is being used, the strain rate multiplier for the principal material is taken from load curve N1 and the multiplier for the reinforcement is taken from load curve N2.

A Suggestion

The LLNL DYNA3D manual from 1991 [Whirley and Hallquist] suggests using the damage function (Mode II.C.) in Material Type 16 with the following set of parameters:

$$\begin{aligned}
 a_0 &= \frac{f'_c}{4} & a_2 &= \frac{1}{3f'_c} & a_{1f} &= 1.5 \\
 a_1 &= \frac{1}{3} & a_{0f} &= \frac{f'_c}{10} & b_1 &= 1.25
 \end{aligned}$$

and a damage table of:

Card 4:	0.0	8.62E-06	2.15E-05	3.14E-05	3.95E-04
	5.17E-04	6.38E-04	7.98E-04		

MAT_PSEUDO_TENSOR**MAT_016**

Card 5:	9.67E-04 4.00E-03	1.41E-03 4.79E-03	1.97E-03 0.909	2.59E-03	3.27E-03
Card 6:	0.309 0.790	0.543 0.630	0.840 0.469	0.975	1.000
Card 7:	0.383 0.086	0.247 0.056	0.173 0.0	0.136	0.114

This set of parameters should give results consistent with Dilger, Koch, and Kowalczyk, [1984] for plane concrete. It has been successfully used for reinforced structures where the reinforcing bars were modeled explicitly with embedded beam and shell elements. The model does not incorporate the major failure mechanism - separation of the concrete and reinforcement leading to catastrophic loss of confinement pressure. However, experience indicates that this physical behavior will occur when this model shows about 4% strain.

***MAT_ORIENTED_CRACK**

This is Material Type 17. This material may be used to model brittle materials which fail due to large tensile stresses.

Card 1	1	2	3	4	5	6	7	8
Variable	MID	RO	E	PR	SIGY	ETAN	FS	PRF
Type	A8	F	F	F	F	F	F	F
Default	none	none	none	none	none	0.0	none	0.0

Optional card for crack propagation to adjacent elements (see remarks):

Card 2	1	2	3	4	5	6	7	8
Variable	SOFT	CVELO						
Type	F	F						
Default	1.0	0.0						

VARIABLE**DESCRIPTION**

MID	Material identification. A unique number or label not exceeding 8 characters must be specified.
RO	Mass density.
E	Young's modulus.
PR	Poisson's ratio.
SIGY	Yield stress.
ETAN	Plastic hardening modulus.
FS	Fracture stress.
PRF	Failure or cutoff pressure (≤ 0.0).

VARIABLE	DESCRIPTION
SOFT	Factor by which the fracture stress is reduced when a crack is coming from failed neighboring element. See remarks.
CVELO	Crack propagation velocity. See remarks.

Remarks:

This is an isotropic elastic-plastic material which includes a failure model with an oriented crack. The von Mises yield condition is given by:

$$\phi = J_2 - \frac{\sigma_y^2}{3}$$

where the second stress invariant, J_2 , is defined in terms of the deviatoric stress components as

$$J_2 = \frac{1}{2} s_{ij} s_{ij}$$

and the yield stress, σ_y , is a function of the effective plastic strain, $\varepsilon_{\text{eff}}^p$, and the plastic hardening modulus, E_p :

$$\sigma_y = \sigma_0 + E_p \varepsilon_{\text{eff}}^p$$

The effective plastic strain is defined as:

$$\varepsilon_{\text{eff}}^p = \int_0^t d\varepsilon_{\text{eff}}^p$$

where

$$d\varepsilon_{\text{eff}}^p = \sqrt{\frac{2}{3} d\varepsilon_{ij}^p d\varepsilon_{ij}^p}$$

and the plastic tangent modulus is defined in terms of the input tangent modulus, E_t , as

$$E_p = \frac{E E_t}{E - E_t}$$

Pressure in this model is found from evaluating an equation of state. A pressure cutoff can be defined such that the pressure is not allowed to fall below the cutoff value.

The oriented crack fracture model is based on a maximum principal stress criterion. When the maximum principal stress exceeds the fracture stress, σ_f , the element fails on a plane perpendicular to the direction of the maximum principal stress. The normal stress and the two shear stresses on that plane are then reduced to zero. This stress reduction is done according to a delay function that reduces the stresses gradually to zero over a small number of time steps. This delay function procedure is used to reduce the ringing that may

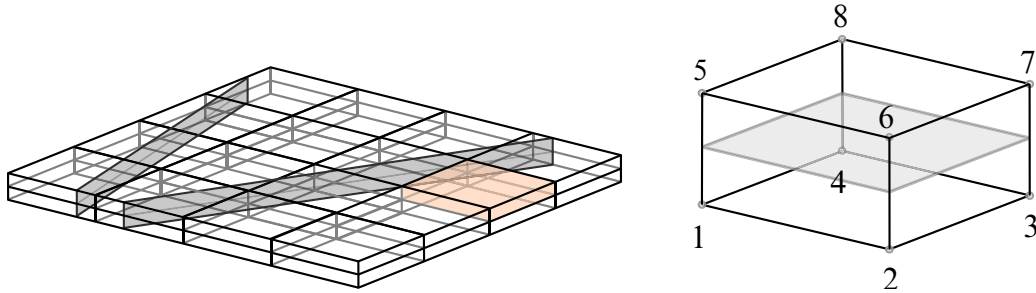

Figure 2-11. Thin structure (2 elements over thickness) with cracks and necessary element numbering.

otherwise be introduced into the system by the sudden fracture. The number of steps for stress reduction is 20 by default (CVELO = 0.0) or it is internally computed if CVELO > 0.0 is given:

$$n_{\text{steps}} = \text{int} \left[\frac{L_e}{\text{CVELO} \times \Delta t} \right]$$

where L_e is characteristic element length and Δt is time step size.

After a tensile fracture, the element will not support tensile stress on the fracture plane, but in compression will support both normal and shear stresses. The orientation of this fracture surface is tracked throughout the deformation, and is updated to properly model finite deformation effects. If the maximum principal stress subsequently exceeds the fracture stress in another direction, the element fails isotropically. In this case the element completely loses its ability to support any shear stress or hydrostatic tension, and only compressive hydrostatic stress states are possible. Thus, once isotropic failure has occurred, the material behaves like a fluid.

This model is applicable to elastic or elastoplastic materials under significant tensile or shear loading when fracture is expected. Potential applications include brittle materials such as ceramics as well as porous materials such as concrete in cases where pressure hardening effects are not significant.

Crack propagation behavior to adjacent elements can be controlled via parameter SOFT for thin, shell-like structures (e.g. only 2 or 3 solids over thickness). Additionally, LS-DYNA has to know where the plane or solid element midplane is at each integration point for projection of crack plane on this element midplane. Therefore, element numbering has to be as shown in [Figure Figure 2-11](#). Only solid element type 1 is supported with that option at the moment.

*MAT_POWER_LAW_PLASTICITY

This is Material Type 18. This is an isotropic plasticity model with rate effects which uses a power law hardening rule.

Card 1	1	2	3	4	5	6	7	8
Variable	MID	RO	E	PR	K	N	SRC	SRP
Type	A8	F	F	F	F	F	F	F
Default	none	none	none	none	none	none	0.0	0.0

Card 2	1	2	3	4	5	6	7	8
Variable	SIGY	VP	EPSF					
Type	F	F	F					
Default	0.0	0.0	0.0					

VARIABLE	DESCRIPTION
MID	Material identification. A unique number or label not exceeding 8 characters must be specified.
RO	Mass density.
E	Young's modulus.
PR	Poisson's ratio.
K	Strength coefficient.
N	Hardening exponent.
SRC	Strain rate parameter, C, if zero, rate effects are ignored.
SRP	Strain rate parameter, P, if zero, rate effects are ignored.

VARIABLE	DESCRIPTION
SIGY	Optional input parameter for defining the initial yield stress, σ_y . Generally, this parameter is not necessary and the strain to yield is calculated as described below. LT.0.02: $\varepsilon_{yp} = \text{SIGY}$ GE.0.02: See below.
EPSF	Plastic failure strain for element deletion.
VP	Formulation for rate effects: EQ.0.0: Scale yield stress (default), EQ.1.0: Viscoplastic formulation.

Remarks:

Elastoplastic behavior with isotropic hardening is provided by this model. The yield stress, σ_y , is a function of plastic strain and obeys the equation:

$$\sigma_y = k\varepsilon^n = k(\varepsilon_{yp} + \bar{\varepsilon}^p)^n$$

where ε_{yp} is the elastic strain to yield and $\bar{\varepsilon}^p$ is the effective plastic strain (logarithmic). If SIGY is set to zero, the strain to yield is found by solving for the intersection of the linearly elastic loading equation with the strain hardening equation:

$$\sigma = E\varepsilon$$

$$\sigma = k \varepsilon^n$$

which gives the elastic strain at yield as:

$$\varepsilon_{yp} = \left(\frac{E}{k}\right)^{\left[\frac{1}{n-1}\right]}$$

If SIGY yield is nonzero and greater than 0.02 then:

$$\varepsilon_{yp} = \left(\frac{\sigma_y}{k}\right)^{\left[\frac{1}{n}\right]}$$

Strain rate is accounted for using the Cowper and Symonds model which scales the yield stress with the factor

$$1 + \left(\frac{\dot{\varepsilon}}{C}\right)^{1/p}$$

where $\dot{\varepsilon}$ is the strain rate. A fully viscoplastic formulation is optional which incorporates the Cowper and Symonds formulation within the yield surface. An additional cost is incurred but the improvement in results can be dramatic.

*MAT_STRAIN_RATE_DEPENDENT_PLASTICITY

This is Material Type 19. A strain rate dependent material can be defined. For an alternative, see Material Type 24. Required is a curve for the yield stress versus the effective strain rate. Optionally, Young’s modulus and the tangent modulus can also be defined versus the effective strain rate. Also, optional failure of the material can be defined either by defining a von Mises stress at failure as a function of the effective strain rate (valid for solids/shells/thick shells) or by defining a minimum time step size (only for shells).

Card 1	1	2	3	4	5	6	7	8
Variable	MID	RO	E	PR	VP			
Type	A8	F	F	F	F			
Default	none	none	none	none	0.0			

Card 2	1	2	3	4	5	6	7	8
Variable	LC1	ETAN	LC2	LC3	LC4	TDEL	RDEF	
Type	F	F	F	F	F	F	F	
Default	none	0.0	0.0	0.0	0.0	0.0	0.0	

VARIABLE	DESCRIPTION
MID	Material identification. A unique number or label not exceeding 8 characters must be specified.
RO	Mass density.
E	Young’s modulus.
PR	Poisson’s ratio.
VP	Formulation for rate effects: EQ.0.0: Scale yield stress (default), EQ.1.0: Viscoplastic formulation

VARIABLE	DESCRIPTION
LC1	Load curve ID defining the yield stress σ_0 as a function of the effective strain rate.
ETAN	Tangent modulus, E_t
LC2	Load curve ID defining Young's modulus as a function of the effective strain rate (available only when VP = 0; not recommended).
LC3	Load curve ID defining tangent modulus as a function of the effective strain rate (optional).
LC4	Load curve ID defining von Mises stress at failure as a function of the effective strain rate (optional).
TDEL	Minimum time step size for automatic element deletion. Use for shells only.
RDEF	Redefinition of failure curve: EQ.1.0: Effective plastic strain, EQ.2.0: Maximum principal stress and absolute value of minimum principal stress, EQ.3.0: Maximum principal stress (release 5 of v.971)

Remarks:

In this model, a load curve is used to describe the yield strength σ_0 as a function of effective strain rate $\dot{\bar{\epsilon}}$ where

$$\dot{\bar{\epsilon}} = \left(\frac{2}{3} \dot{\epsilon}'_{ij} \dot{\epsilon}'_{ij} \right)^{1/2}$$

and the prime denotes the deviatoric component. The strain rate is available for post-processing as the first stored history variable. If the viscoplastic option is active, the plastic strain rate is output; otherwise, the effective strain rate defined above is output.

The yield stress is defined as

$$\sigma_y = \sigma_0(\dot{\bar{\epsilon}}) + E_p \bar{\epsilon}^p$$

where $\bar{\epsilon}^p$ is the effective plastic strain and E_p is given in terms of Young's modulus and the tangent modulus by

$$E_p = \frac{EE_t}{E - E_t}$$

Both Young's modulus and the tangent modulus may optionally be made functions of strain rate by specifying a load curve ID giving their values as a function of strain rate. If these load curve ID's are input as 0, then the constant values specified in the input are used.

Note that all load curves used to define quantities as a function of strain rate must have the same number of points at the same strain rate values. This requirement is used to allow vectorized interpolation to enhance the execution speed of this constitutive model.

This model also contains a simple mechanism for modeling material failure. This option is activated by specifying a load curve ID defining the effective stress at failure as a function of strain rate. For solid elements, once the effective stress exceeds the failure stress the element is deemed to have failed and is removed from the solution. For shell elements the entire shell element is deemed to have failed if all integration points through the thickness have an effective stress that exceeds the failure stress. After failure the shell element is removed from the solution.

In addition to the above failure criterion, this material model also supports a shell element deletion criterion based on the maximum stable time step size for the element, Δt_{\max} . Generally, Δt_{\max} goes down as the element becomes more distorted. To assure stability of time integration, the global LS-DYNA time step is the minimum of the Δt_{\max} values calculated for all elements in the model. Using this option allows the selective deletion of elements whose time step Δt_{\max} has fallen below the specified minimum time step, Δt_{crit} . Elements which are severely distorted often indicate that material has failed and supports little load, but these same elements may have very small time steps and therefore control the cost of the analysis. This option allows these highly distorted elements to be deleted from the calculation, and, therefore, the analysis can proceed at a larger time step, and, thus, at a reduced cost. Deleted elements do not carry any load, and are deleted from all applicable slide surface definitions. Clearly, this option must be judiciously used to obtain accurate results at a minimum cost.

A fully viscoplastic formulation is optional which incorporates the rate formulation within the yield surface. An additional cost is incurred but the improvement in results can be dramatic.

***MAT_RIGID**

This is Material 20. Parts made from this material are considered to belong to a rigid body (for each part ID). Also, the coupling of a rigid body with MADYMO and CAL3D can be defined via this material. Alternatively, a VDA surface can be attached as surface to model the geometry, e.g., for the tooling in metalforming applications. Also, global and local constraints on the mass center can be optionally defined. Optionally, a local consideration for output and user-defined airbag sensors can be chosen.

Card 1	1	2	3	4	5	6	7	8
Variable	MID	RO	E	PR	N	COUPLE	M	ALIAS or RE
Type	A8	F	F	F	F	F	F	C/F
Default	none	none	none	none	0	0	0	blank none

Card 2	1	2	3	4	5	6	7	8
Variable	CMO	CON1	CON2					
Type	F	F	F					
Default	0	0	0					

Optional for output (Must be included but may be left blank).

Card 3	1	2	3	4	5	6	7	8
Variable	LC0 or A1	A2	A3	V1	V2	V3		
Type	F	F	F	F	F	F		
Default	0	0	0	0	0	0		

VARIABLE	DESCRIPTION
MID	Material identification. A unique number or label not exceeding 8 characters must be specified.
RO	Mass density
E	Young's modulus. Reasonable values have to be chosen for contact analysis (choice of penalty), see Remarks below.
PR	Poisson's ratio. Reasonable values have to be chosen for contact analysis (choice of penalty), see Remarks below.
N	MADYMO3D 5.4 coupling flag, n: EQ.0: use normal LS-DYNA rigid body updates, GT.0: the rigid body is coupled to MADYMO 5.4 ellipsoid number n LT.0: the rigid body is coupled to MADYMO 5.4 plane number n .
COUPLE	Coupling option if applicable: EQ.-1: attach VDA surface in ALIAS (defined in the eighth field) and automatically generate a mesh for viewing the surface in LS-PREPOST. MADYMO 5.4 / CAL3D coupling option: EQ.0: the undeformed geometry input to LS-DYNA corresponds to the local system for MADYMO 5.4 / CAL3D. The finite element mesh is input, EQ.1: the undeformed geometry input to LS-DYNA corresponds to the global system for MADYMO 5.4 / CAL3D, EQ.2: generate a mesh for the ellipsoids and planes internally in LS-DYNA.
M	MADYMO3D 5.4 coupling flag, m: EQ.0: use normal LS-DYNA rigid body updates, EQ.m: this rigid body corresponds to MADYMO rigid body number m. Rigid body updates are performed by MADYMO.
ALIAS	VDA surface alias name, see Appendix L.

VARIABLE	DESCRIPTION
RE	MADYMO 6.0.1 External Reference Number
CMO	Center of mass constraint option, CMO: EQ.+1.0: constraints applied in global directions, EQ.0.0: no constraints, EQ.-1.0: constraints applied in local directions (SPC constraint).
CON1	First constraint parameter: If CMO = +1.0, then specify global translational constraint: EQ.0: no constraints, EQ.1: constrained x displacement, EQ.2: constrained y displacement, EQ.3: constrained z displacement, EQ.4: constrained x and y displacements, EQ.5: constrained y and z displacements, EQ.6: constrained z and x displacements, EQ.7: constrained x, y, and z displacements. If CMO = -1.0, then specify local coordinate system ID. See *DEFINE_COORDINATE_OPTION: This coordinate system is fixed in time.
CON2	Second constraint parameter: If CMO = +1.0, then specify global rotational constraint: EQ.0: no constraints, EQ.1: constrained x rotation, EQ.2: constrained y rotation, EQ.3: constrained z rotation, EQ.4: constrained x and y rotations, EQ.5: constrained y and z rotations, EQ.6: constrained z and x rotations, EQ.7: constrained x, y, and z rotations.

VARIABLE	DESCRIPTION
	<p>If CM0 = -1.0, then specify local (SPC) constraint:</p> <p>EQ.000000: no constraint, EQ.100000: constrained x translation, EQ.010000: constrained y translation, EQ.001000: constrained z translation, EQ.000100: constrained x rotation, EQ.000010: constrained y rotation, EQ.000001: constrained z rotation.</p> <p>Any combination of local constraints can be achieved by adding the number 1 into the corresponding column.</p>
LCO	Local coordinate system number for output.
A1 - V3	<p>Alternative method for specifying local system below:</p> <p>Define two vectors a and v, fixed in the rigid body which are used for output and the user defined airbag sensor subroutines. The output parameters are in the directions a, b, and c where the latter are given by the cross products $\mathbf{c} = \mathbf{a} \times \mathbf{v}$ and $\mathbf{b} = \mathbf{c} \times \mathbf{a}$. This input is optional.</p>

Remarks:

The rigid material type 20 provides a convenient way of turning one or more parts comprised of beams, shells, or solid elements into a rigid body. Approximating a deformable body as rigid is a preferred modeling technique in many real world applications. For example, in sheet metal forming problems the tooling can properly and accurately be treated as rigid. In the design of restraint systems the occupant can, for the purposes of early design studies, also be treated as rigid. Elements which are rigid are bypassed in the element processing and no storage is allocated for storing history variables; consequently, the rigid material type is very cost efficient.

Two unique rigid part ID's may not share common nodes unless they are merged together using the rigid body merge option. A rigid body may be made up of disjoint finite element meshes, however. LS-DYNA assumes this is the case since this is a common practice in setting up tooling meshes in forming problems.

All elements which reference a given part ID corresponding to the rigid material should be contiguous, but this is not a requirement. If two disjoint groups of elements on opposite sides of a model are modeled as rigid, separate part ID's should be created for each of the

contiguous element groups if each group is to move independently. This requirement arises from the fact that LS-DYNA internally computes the six rigid body degrees-of-freedom for each rigid body (rigid material or set of merged materials), and if disjoint groups of rigid elements use the same part ID, the disjoint groups will move together as one rigid body.

Inertial properties for rigid materials may be defined in either of two ways. By default, the inertial properties are calculated from the geometry of the constituent elements of the rigid material and the density specified for the part ID. Alternatively, the inertial properties and initial velocities for a rigid body may be directly defined, and this overrides data calculated from the material property definition and nodal initial velocity definitions.

Young's modulus, E , and Poisson's ratio, ν are used for determining sliding interface parameters if the rigid body interacts in a contact definition. Realistic values for these constants should be defined since unrealistic values may contribute to numerical problem in contact.

Constraint directions for rigid materials (CMO equal to +1 or -1) are fixed, that is, not updated, with time. To impose a constraint on a rigid body such that the constraint direction is updated as the rigid body rotates, use `*BOUNDARY_PRESCRIBED_MOTION_-RIGID_LOCAL`.

It is strongly advised that nodal constraints, e.g., by `*BOUNDARY_SPC_OPTION`, not be applied to nodes of a rigid body as doing so may compromise the intended constraints in the case of an explicit simulation. Such SPCs will be skipped in an implicit simulation and a warning issued.

If the intended constraints are not with respect to the calculated center-of-mass of the rigid body, `*CONSTRAINED_JOINT_OPTION` may often be used to obtain the desired effect. This approach typically entails defining a second rigid body which is fully constrained and then defining a joint between the two rigid bodies. Another alternative for defining rigid body constraints that are not with respect to the calculated center-of-mass of the rigid body is to manually specify the initial center-of-mass location using `*PART_INERTIA`. When using `*PART_INERTIA`, a full set of mass properties must be specified and the user must understand that the dynamic behavior of the rigid body is affected by its mass properties.

For coupling with MADYMO 5.4.1, only basic coupling is available.

The coupling flags (N and M) must match with SYSTEM and ELLIPSOID/PLANE in the MADYMO input file and the coupling option (COUPLE) must be defined.

For coupling with MADYMO 6.0.1, both basic and extended coupling are available:

1. **Basic Coupling:** The external reference number (RE) must match with the external reference number in the MADYMO XML input file. The coupling option (COUPLE) must be defined.

2. Extended Coupling: Under this option MADYMO will handle the contact between the MADYMO and LS-DYNA models. The external reference number (RE) and the coupling option (COUPLE) are not needed. All coupling surfaces that interface with the MADYMO models need to be defined in *CONTACT_COUPLING.

***MAT_ORTHOTROPIC_THERMAL_{OPTION}**

This is Material Type 21. A linearly elastic, orthotropic material with orthotropic thermal expansion.

Available options include:

<BLANK>

FAILURE

Card 1	1	2	3	4	5	6	7	8
Variable	MID	RO	EA	EB	EC	PRBA	PRCA	PRCB
Type	A8	F	F	F	F	F	F	F

Card 2	1	2	3	4	5	6	7	8
Variable	GAB	GBC	GCA	AA	AB	AC	AOPT	MACF
Type	F	F	F	F	F	F	F	I

Card 3	1	2	3	4	5	6	7	8
Variable	XP	YP	ZP	A1	A2	A3		
Type	F	F	F	F	F	F		

Card 4	1	2	3	4	5	6	7	8
Variable	V1	V2	V3	D1	D2	D3	BETA	REF
Type	F	F	F	F	F	F	F	

Required for failure.

Card	1	2	3	4	5	6	7	8
Variable	A1	A11	A2	A5	A55	A4	NIP	
Type	F	F	F	F	F	F	F	

VARIABLE**DESCRIPTION**

MID	Material identification. A unique number or label not exceeding 8 characters must be specified.
RO	Mass density.
EA	E_a , Young's modulus in a-direction.
EB	E_b , Young's modulus in b-direction.
EC	E_c , Young's modulus in c-direction.
PRBA	ν_{ba} , Poisson's ratio, ba.
PRCA	ν_{ca} , Poisson's ratio, ca.
PRCB	ν_{cb} , Poisson's ratio, cb
GAB	G_{ab} , Shear modulus, ab.
GBC	G_{bc} , Shear modulus, bc.
GCA	G_{ca} , Shear modulus, ca.
AA	α_a , coefficients of thermal expansion in the a-direction.
AB	α_b , coefficients of thermal expansion in the b-direction.
AC	α_c , coefficients of thermal expansion in the c-direction.

VARIABLE	DESCRIPTION
AOPT	<p>Material axes option (see <i>MAT_OPTION TROPIC_ELASTIC</i> for a more complete description):</p> <p>EQ.0.0: locally orthotropic with material axes determined by element nodes 1, 2, and 4, as with <i>*DEFINE_COORDINATE_NODES</i>.</p> <p>EQ.1.0: locally orthotropic with material axes determined by a point in space and the global location of the element center; this is the <i>a</i>-direction. This option is for solid elements only.</p> <p>EQ.2.0: globally orthotropic with material axes determined by vectors defined below, as with <i>*DEFINE_COORDINATE_VECTOR</i>.</p> <p>EQ.3.0: locally orthotropic material axes determined by rotating the material axes about the element normal by an angle, <i>BETA</i>, from a line in the plane of the element defined by the cross product of the vector <i>v</i> with the element normal.</p> <p>EQ.4.0: locally orthotropic in cylindrical coordinate system with the material axes determined by a vector <i>v</i>, and an originating point, <i>p</i>, which define the centerline axis. This option is for solid elements only.</p> <p>LT.0.0: the absolute value of AOPT is a coordinate system ID number (CID on <i>*DEFINE_COORDINATE_NODES</i>, <i>*DEFINE_COORDINATE_SYSTEM</i> or <i>*DEFINE_COORDINATE_VECTOR</i>). Available in R3 version of 971 and later.</p>
MACF	<p>Material axes change flag for brick elements:</p> <p>EQ.1: No change, default,</p> <p>EQ.2: switch material axes <i>a</i> and <i>b</i>,</p> <p>EQ.3: switch material axes <i>a</i> and <i>c</i>,</p> <p>EQ.4: switch material axes <i>b</i> and <i>c</i>.</p>
XP, YP, ZP	Coordinates of point p for AOPT = 1 and 4.
A1, A2, A3	Components of vector a for AOPT = 2.
V1, V2, V3	Components of vector v for AOPT = 3 and 4.

VARIABLE	DESCRIPTION
D1, D2, D3	Components of vector d for AOPT = 2.
BETA	Material angle in degrees for AOPT = 3, may be overridden on the element card, see *ELEMENT_SHELL_BETA or *ELEMENT_SOLID_ORTHO.
REF	Use reference geometry to initialize the stress tensor. The reference geometry is defined by the keyword:*INITIAL_FOAM_REFERENCE_GEOMETRY (see there for more details). EQ.0.0: off, EQ.1.0: on.
A1, A11, A2	Coefficients for the matrix dominated failure criterion.
A5, A55, A4	Coefficients for the fiber dominated failure criterion.

Remarks:

In the implementation for three-dimensional continua a total Lagrangian formulation is used. In this approach the material law that relates second Piola-Kirchhoff stress **S** to the Green-St. Venant strain **E** is

$$\mathbf{S} = \mathbf{C} \cdot \mathbf{E} = \mathbf{T}^t \mathbf{C}_l \mathbf{T} \cdot \mathbf{E}$$

where **T** is the transformation matrix [Cook 1974].

$$\mathbf{T} = \begin{bmatrix} l_1^2 & m_1^2 & n_1^2 & l_1 m_1 & m_1 n_1 & n_1 l_1 \\ l_2^2 & m_2^2 & n_2^2 & l_2 m_2 & m_2 n_2 & n_2 l_2 \\ l_3^2 & m_3^2 & n_3^2 & l_3 m_3 & m_3 n_3 & n_3 l_3 \\ 2l_1 l_2 & 2m_1 m_2 & 2n_1 n_2 & (l_1 m_2 + l_2 m_1) & (m_1 n_2 + m_2 n_1) & (n_1 l_2 + n_2 l_1) \\ 2l_2 l_3 & 2m_2 m_3 & 2n_2 n_3 & (l_2 m_3 + l_3 m_2) & (m_2 n_3 + m_3 n_2) & (n_2 l_3 + n_3 l_2) \\ 2l_3 l_1 & 2m_3 m_1 & 2n_3 n_1 & (l_3 m_1 + l_1 m_3) & (m_3 n_1 + m_1 n_3) & (n_3 l_1 + n_1 l_3) \end{bmatrix}$$

l_i, m_i, n_i are the direction cosines

$$x'_i = l_i x_1 + m_i x_2 + n_i x_3 \text{ for } i = 1, 2, 3$$

and x'_i denotes the material axes. The constitutive matrix C_l is defined in terms of the material axes as

$$C_l^{-1} = \begin{bmatrix} \frac{1}{E_{11}} & -\frac{\nu_{21}}{E_{22}} & -\frac{\nu_{31}}{E_{33}} & 0 & 0 & 0 \\ -\frac{\nu_{12}}{E_{11}} & \frac{1}{E_{22}} & -\frac{\nu_{32}}{E_{33}} & 0 & 0 & 0 \\ -\frac{\nu_{13}}{E_{11}} & -\frac{\nu_{23}}{E_{22}} & \frac{1}{E_{33}} & 0 & 0 & 0 \\ 0 & 0 & 0 & \frac{1}{G_{12}} & 0 & 0 \\ 0 & 0 & 0 & 0 & \frac{1}{G_{23}} & 0 \\ 0 & 0 & 0 & 0 & 0 & \frac{1}{G_{31}} \end{bmatrix}$$

where the subscripts denote the material axes, i.e.,

$$\nu_{ij} = \nu_{x'_i x'_j} \quad \text{and} \quad E_{ii} = E_{x'_i}$$

Since C_l is symmetric

$$\frac{\nu_{12}}{E_{11}} = \frac{\nu_{21}}{E_{22}}, \dots$$

The vector of Green-St. Venant strain components is

$$E^t = [E_{11}, E_{22}, E_{33}, E_{12}, E_{23}, E_{31}]$$

which include the local thermal strains which are integrated in time:

$$\varepsilon_{aa}^{n+1} = \varepsilon_{aa}^n + \alpha_a (T^{n+1} - T^n)$$

$$\varepsilon_{bb}^{n+1} = \varepsilon_{bb}^n + \alpha_b (T^{n+1} - T^n)$$

$$\varepsilon_{cc}^{n+1} = \varepsilon_{cc}^n + \alpha_c (T^{n+1} - T^n)$$

After computing S_{ij} we then obtain the Cauchy stress:

$$\sigma_{ij} = \frac{\rho}{\rho_0} \frac{\partial x_i}{\partial X_k} \frac{\partial x_j}{\partial X_l} S_{kl}$$

This model will predict realistic behavior for finite displacement and rotations as long as the strains are small.

In the implementation for shell elements, the stresses are integrated in time and are updated in the corotational coordinate system. In this procedure the local material axes are assumed to remain orthogonal in the deformed configuration. This assumption is valid if the strains remain small.

The failure models were derived by William Feng. The first one defines the matrix dominated failure mode,

$$F_m = A_1(I_1 - 3) + A_{11}(I_1 - 3)^2 + A_2(I_2 - 3) - 1$$

and the second defines the fiber dominated failure mode,

$$F_f = A_5(I_5 - 1) + A_{55}(I_5 - 1)^2 + A_4(I_4 - 1) - 1.$$

When either is greater than zero, the integration point fails, and the element is deleted after NIP integration points fail.

The coefficients A_i are defined in the input and the invariants I_i are the strain invariants

$$I_1 = \sum_{\alpha=1,3} C_{\alpha\alpha}$$

$$I_2 = \frac{1}{2} [I_1^2 - \sum_{\alpha,\beta=1,3} C_{\alpha\beta}^2]$$

$$I_3 = \det(C)$$

$$I_4 = \sum_{\alpha,\beta,\gamma=1,3} V_\alpha C_{\alpha\gamma} C_{\gamma\beta} V_\beta$$

$$I_5 = \sum_{\alpha,\beta=1,3} V_\alpha C_{\alpha\beta} V_\beta$$

and C is the Cauchy strain tensor and V is the fiber direction in the undeformed state. By convention in this material model, the fiber direction is aligned with the a direction of the local orthotropic coordinate system.

***MAT_COMPOSITE_DAMAGE**

This is Material Type 22. An orthotropic material with optional brittle failure for composites can be defined following the suggestion of [Chang and Chang 1987a, 1987b]. Three failure criteria are possible, see the LS-DYNA Theory Manual. By using the user defined integration rule, see *INTEGRATION_SHELL, the constitutive constants can vary through the shell thickness. For all shells, except the DKT formulation, laminated shell theory can be activated to properly model the transverse shear deformation. Lamination theory is applied to correct for the assumption of a uniform constant shear strain through the thickness of the shell. For sandwich shells where the outer layers are much stiffer than the inner layers, the response will tend to be too stiff unless lamination theory is used. To turn on lamination theory see *CONTROL_SHELL.

Card 1	1	2	3	4	5	6	7	8
Variable	MID	RO	EA	EB	EC	PRBA	PRCA	PRCB
Type	A8	F	F	F	F	F	F	F
Default	none	none	none	none	none	none	none	none

Card 2	1	2	3	4	5	6	7	8
Variable	GAB	GBC	GCA	KFAIL	AOPT	MACF		
Type	F	F	F	F	F	I		
Default	none	none	none	0.0	0.0	0		

Card 3	1	2	3	4	5	6	7	8
Variable	XP	YP	ZP	A1	A2	A3		
Type	F	F	F	F	F	F		
Default	0.0	0.0	0.0	0.0	0.0	0.0		

Card 4	1	2	3	4	5	6	7	8
Variable	V1	V2	V3	D1	D2	D3	BETA	
Type	F	F	F	F	F	F	F	
Default	0.0	0.0	0.0	0.0	0.0	0.0	0.0	

Card 5	1	2	3	4	5	6	7	8
Variable	SC	XT	YT	YC	ALPH	SN	SYZ	SZX
Type	F	F	F	F	F	F	F	F
Default	none	none	none	none	none	none	none	none

VARIABLE**DESCRIPTION**

MID	Material identification. A unique number or label not exceeding 8 characters must be specified.
RO	Mass density
EA	E_a , Young's modulus in a-direction.
EB	E_b , Young's modulus in b-direction.
EC	E_c , Young's modulus in c-direction.
PRBA	ν_{ba} , Poisson ratio, ba.
PRCA	ν_{ca} , Poisson ratio, ca.
PRCB	ν_{cb} , Poisson ratio, cb.
GAB	G_{ab} , Shear modulus, ab.
GBC	G_{bc} , Shear modulus, bc.
GCA	G_{ca} , Shear modulus, ca.
KFAIL	Bulk modulus of failed material. Necessary for compressive failure.

VARIABLE	DESCRIPTION
AOPT	<p>Material axes option (see <i>MAT_OPTION TROPIC_ELASTIC</i> for a more complete description):</p> <p>EQ.0.0: locally orthotropic with material axes determined by element nodes 1, 2, and 4, as with <i>*DEFINE_COORDINATE_NODES</i>.</p> <p>EQ.1.0: locally orthotropic with material axes determined by a point in space and the global location of the element center; this is the a-direction. This option is for solid elements only.</p> <p>EQ.2.0: globally orthotropic with material axes determined by vectors defined below, as with <i>*DEFINE_COORDINATE_VECTOR</i>.</p> <p>EQ.3.0: locally orthotropic material axes determined by rotating the material axes about the element normal by an angle, BETA, from a line in the plane of the element defined by the cross product of the vector <i>v</i> with the element normal.</p> <p>EQ.4.0: locally orthotropic in cylindrical coordinate system with the material axes determined by a vector <i>v</i>, and an originating point, <i>p</i>, which define the centerline axis. This option is for solid elements only.</p> <p>LT.0.0: the absolute value of AOPT is a coordinate system ID number (CID on <i>*DEFINE_COORDINATE_NODES</i>, <i>*DEFINE_COORDINATE_SYSTEM</i> or <i>*DEFINE_COORDINATE_VECTOR</i>). Available in R3 version of 971 and later.</p>
MACF	<p>Material axes change flag for brick elements:</p> <p>EQ.1: No change, default,</p> <p>EQ.2: switch material axes a and b,</p> <p>EQ.3: switch material axes a and c,</p> <p>EQ.4: switch material axes b and c.</p>
XP, YP, ZP	Coordinates of point p for AOPT = 1 and 4.
A1, A2, A3	Components of vector a for AOPT = 2.
V1, V2, V3	Components of vector v for AOPT = 3 and 4.

VARIABLE	DESCRIPTION
D1, D2, D3	Components of vector d for AOPT = 2.
BETA	Material angle in degrees for AOPT = 3, may be overridden on the element card, see *ELEMENT_SHELL_BETA or *ELEMENT_SOLID_ORTHO.
SC	Shear strength, ab plane, see the LS-DYNA Theory Manual.
XT	Longitudinal tensile strength, a-axis, see the LS-DYNA Theory Manual.
YT	Transverse tensile strength, b-axis.
YC	Transverse compressive strength, b-axis (positive value).
ALPH	Shear stress parameter for the nonlinear term, see the LS-DYNA Theory Manual. Suggested range 0 – 0.5.
SN	Normal tensile strength (<i>solid elements only</i>)
SYZ	Transverse shear strength (<i>solid elements only</i>)
SZX	Transverse shear strength (<i>solid elements only</i>)

Remarks:

The number of additional integration point variables for shells written to the d3plot database is input by the optional *DATABASE_EXTENT_BINARY as variable NEIPS. These additional history variables are tabulated below (*i* = shell integration point):

History Variable	Description	Value	LS-PrePost history variable
ef(<i>i</i>)	tensile fiber mode	1 - elastic 0 - failed	See table below
cm(<i>i</i>)	tensile matrix mode		1
ed(<i>i</i>)	compressive matrix mode		2

The following components are stored as element component 7 instead of the effective plastic strain. Note that ef(*i*) for *i* = 1, 2, 3 is not retrievable.

Description	Integration point
$\frac{1}{n_{ip}} \sum_{i=1}^{n_{ip}} ef(i)$	1
$\frac{1}{n_{ip}} \sum_{i=1}^{n_{ip}} cm(i)$	2
$\frac{1}{n_{ip}} \sum_{i=1}^{n_{ip}} ed(i)$	3
ef(i) for $i > 3$	i

*MAT_TEMPERATURE_DEPENDENT_ORTHOTROPIC

This is Material Type 23. An orthotropic elastic material with arbitrary temperature dependency can be defined.

Card 1	1	2	3	4	5	6	7	8
Variable	MID	RO	AOPT	REF	MACF			
Type	A8	F	F	F	I			

Card 2	1	2	3	4	5	6	7	8
Variable	XP	YP	ZP	A1	A2	A3		
Type	F	F	F	F	F	F		

Card 3	1	2	3	4	5	6	7	8
Variable	V1	V2	V3	D1	D2	D3	BETA	
Type	F	F	F	F	F	F	F	

Temperature Card Pairs. Define one set of constants on two cards using formats 4 and 5 for each temperature point. Up to 48 points (96 cards) can be defined. The next "*" card terminates the input.

First Temperature Card.

Card 4	1	2	3	4	5	6	7	8
Variable	E _{Ai}	E _{Bi}	E _{Ci}	PR _{BAi}	PR _{CAi}	PR _{CBi}		
Type	F	F	F	F	F	F		

Second Temperature Card

Card 5	1	2	3	4	5	6	7	8
Variable	AAi	ABi	ACi	GABi	GBCi	GCAi	Ti	
Type	F	F	F	F	F	F	F	

VARIABLE**DESCRIPTION**

MID	Material identification. A unique number or label not exceeding 8 characters must be specified.
RO	Mass density.
AOPT	<p>Material axes option (see <code>MAT_OPTIONTROPIC_ELASTIC</code> for a more complete description):</p> <p>EQ.0.0: locally orthotropic with material axes determined by element nodes 1, 2, and 4, as with <code>*DEFINE_COORDINATE_NODES</code>.</p> <p>EQ.1.0: locally orthotropic with material axes determined by a point in space and the global location of the element center; this is the a-direction. This option is for solid elements only.</p> <p>EQ.2.0: globally orthotropic with material axes determined by vectors defined below, as with <code>*DEFINE_COORDINATE_VECTOR</code>.</p> <p>EQ.3.0: locally orthotropic material axes determined by rotating the material axes about the element normal by an angle, <code>BETA</code>, from a line in the plane of the element defined by the cross product of the vector <code>v</code> with the element normal.</p> <p>EQ.4.0: locally orthotropic in cylindrical coordinate system with the material axes determined by a vector <code>v</code>, and an originating point, <code>p</code>, which define the centerline axis. This option is for solid elements only.</p> <p>LT.0.0: the absolute value of <code>AOPT</code> is a coordinate system ID number (<code>CID</code> on <code>*DEFINE_COORDINATE_NODES</code>, <code>*DEFINE_COORDINATE_SYSTEM</code> or <code>*DEFINE_COORDINATE_VECTOR</code>). Available in R3 version of 971 and later.</p>

VARIABLE	DESCRIPTION
REF	Use reference geometry to initialize the stress tensor. The reference geometry is defined by the keyword:*INITIAL_FOAM_REFERENCE_GEOMETRY (see for more details). EQ.0.0: off, EQ.1.0: on.
MACF	Material axes change flag for brick elements: EQ.1: No change, default, EQ.2: switch material axes a and b, EQ.3: switch material axes a and c, EQ.4: switch material axes b and c.
XP, YP, ZP	Coordinates of point p for AOPT = 1 and 4.
A1, A2, A3	Components of vector a for AOPT = 2.
V1, V2, V3	Components of vector v for AOPT = 3 and 4.
D1, D2, D3	Components of vector d for AOPT = 2.
BETA	Material angle in degrees for AOPT = 3, may be overridden on the element card, see *ELEMENT_SHELL_BETA or *ELEMENT_SOLID_ORTHO.
EAI	E_a , Young's modulus in a-direction at temperature T_i .
EBI	E_b , Young's modulus in b-direction at temperature T_i .
ECI	E_c , Young's modulus in c-direction at temperature T_i .
PRBAI	ν_{ba} , Poisson's ratio ba at temperature T_i .
PRCAI	ν_{ca} , Poisson's ratio ca at temperature T_i .
PRCBI	ν_{cb} , Poisson's ratio cb at temperature T_i .
AAI	α_a , coefficient of thermal expansion in a-direction at temperature T_i .
ABI	α_b , coefficient of thermal expansion in b-direction at temperature T_i .
ACI	α_c , coefficient of thermal expansion in c-direction at temperature T_i .

VARIABLE	DESCRIPTION
GABi	G_{ab} , Shear modulus ab at temperature T_i .
GBCi	G_{bc} , Shear modulus bc at temperature T_i .
GCAi	G_{ca} , Shear modulus ca at temperature T_i .
T_i	i th temperature

Remarks:

In the implementation for three-dimensional continua a total Lagrangian formulation is used. In this approach the material law that relates second Piola-Kirchhoff stress S to the Green-St. Venant strain E is

$$S = C \cdot E = T^t C_l T \cdot E$$

where T is the transformation matrix [Cook 1974].

$$T = \begin{bmatrix} l_1^2 & m_1^2 & n_1^2 & l_1 m_1 & m_1 n_1 & n_1 l_1 \\ l_2^2 & m_2^2 & n_2^2 & l_2 m_2 & m_2 n_2 & n_2 l_2 \\ l_3^2 & m_3^2 & n_3^2 & l_3 m_3 & m_3 n_3 & n_3 l_3 \\ 2l_1 l_2 & 2m_1 m_2 & 2n_1 n_2 & (l_1 m_2 + l_2 m_1) & (m_1 n_2 + m_2 n_1) & (n_1 l_2 + n_2 l_1) \\ 2l_2 l_3 & 2m_2 m_3 & 2n_2 n_3 & (l_2 m_3 + l_3 m_2) & (m_2 n_3 + m_3 n_2) & (n_2 l_3 + n_3 l_2) \\ 2l_3 l_1 & 2m_3 m_1 & 2n_3 n_1 & (l_3 m_1 + l_1 m_3) & (m_3 n_1 + m_1 n_3) & (n_3 l_1 + n_1 l_3) \end{bmatrix}$$

l_i, m_i, n_i are the direction cosines

$$x'_i = l_i x_1 + m_i x_2 + n_i x_3 \text{ for } i = 1, 2, 3$$

and x'_i denotes the material axes. The temperature dependent constitutive matrix C_l is defined in terms of the material axes as

$$C_l^{-1} = \begin{bmatrix} 1 & v_{21}(T) & v_{31}(T) & 0 & 0 & 0 \\ \frac{E_{11}(T)}{E_{11}(T)} & -\frac{E_{22}(T)}{E_{22}(T)} & -\frac{E_{33}(T)}{E_{33}(T)} & 0 & 0 & 0 \\ v_{12}(T) & 1 & v_{32}(T) & 0 & 0 & 0 \\ -\frac{E_{11}(T)}{E_{11}(T)} & \frac{E_{22}(T)}{E_{22}(T)} & -\frac{E_{33}(T)}{E_{33}(T)} & 0 & 0 & 0 \\ v_{13}(T) & v_{23}(T) & 1 & 0 & 0 & 0 \\ -\frac{E_{11}(T)}{E_{11}(T)} & -\frac{E_{22}(T)}{E_{22}(T)} & \frac{E_{33}(T)}{E_{33}(T)} & 0 & 0 & 0 \\ 0 & 0 & 0 & \frac{1}{G_{12}(T)} & 0 & 0 \\ 0 & 0 & 0 & 0 & \frac{1}{G_{23}(T)} & 0 \\ 0 & 0 & 0 & 0 & 0 & \frac{1}{G_{31}(T)} \end{bmatrix}$$

where the subscripts denote the material axes, i.e.,

$$v_{ij} = v_{x'_i x'_j} \quad \text{and} \quad E_{ii} = E_{x'_i}$$

Since C_I is symmetric

$$\frac{v_{12}}{E_{11}} = \frac{v_{21}}{E_{22}}, \dots$$

The vector of Green-St. Venant strain components is

$$\mathbf{E}^t = [E_{11}, E_{22}, E_{33}, E_{12}, E_{23}, E_{31}]$$

which include the local thermal strains which are integrated in time:

$$\varepsilon_{aa}^{n+1} = \varepsilon_{aa}^n + \alpha_a \left(T^{n+\frac{1}{2}} \right) [T^{n+1} - T^n]$$

$$\varepsilon_{bb}^{n+1} = \varepsilon_{bb}^n + \alpha_b \left(T^{n+\frac{1}{2}} \right) [T^{n+1} - T^n]$$

$$\varepsilon_{cc}^{n+1} = \varepsilon_{cc}^n + \alpha_c \left(T^{n+\frac{1}{2}} \right) [T^{n+1} - T^n]$$

After computing S_{ij} we then obtain the Cauchy stress:

$$\sigma_{ij} = \frac{\rho}{\rho_0} \frac{\partial x_i}{\partial X_k} \frac{\partial x_j}{\partial X_l} S_{kl}$$

This model will predict realistic behavior for finite displacement and rotations as long as the strains are small.

For shell elements, the stresses are integrated in time and are updated in the corotational coordinate system. In this procedure the local material axes are assumed to remain orthogonal in the deformed configuration. This assumption is valid if the strains remain small.

***MAT_PIECEWISE_LINEAR_PLASTICITY_{OPTION}**

Available options include:

<BLANK>

HAZ

LOG_INTERPOLATION

STOCHASTIC

This is Material Type 24. An elasto-plastic material with an arbitrary stress versus strain curve and arbitrary strain rate dependency can be defined. See also Remark below. Also, failure based on a plastic strain or a minimum time step size can be defined. For another model with a more comprehensive failure criteria see MAT_MODIFIED_PIECEWISE_LINEAR_PLASTICITY. If considering laminated or sandwich shells with non-uniform material properties (this is defined through the user specified integration rule), the model, MAT_LAYERED_LINEAR_PLASTICITY, is recommended. If solid elements are used and if the elastic strains before yielding are finite, the model, MAT_FINITE_ELASTIC_STRAIN_PLASTICITY, treats the elastic strains using a hyperelastic formulation.

The HAZ option allows the modeling of the heat affected zones in shell elements with solid element spot welds. The stress-strain, strain rate, and failure strain may be optionally expanded from curves and tables to tables and three-dimensional tables, respectively, to account for the distance of the material from the closest spotweld. If a part ID uses this constitutive model, then during initialization, the distance of each shell integration point from the centroid of the weld is computed and stored as a history variable. Consequently, it is possible that each integration point within the shell element will possess a unique distance. No other input is required for spot welds to activate the heat affected zones. Additional input is required if tailor line welds are used in metal forming simulations or to simulate the behavior along trim lines.

The LOG_INTERPOLATION option interpolates the strain rate effect in table LCSS with logarithmic interpolation.

The STOCHASTIC option allows spatially varying yield and failure behavior. See *DEFINE_STOCHASTIC_VARIATION for additional information.

Card 1	1	2	3	4	5	6	7	8
Variable	MID	RO	E	PR	SIGY	ETAN	FAIL	TDEL
Type	A8	F	F	F	F	F	F	F
Default	none	none	none	none	none	0.0	10.E+20	0

Card 2	1	2	3	4	5	6	7	8
Variable	C	P	LCSS	LCSR	VP	LCF		
Type	F	F	F	F	F	F		
Default	0	0	0	0	0	0		

Card 3	1	2	3	4	5	6	7	8
Variable	EPS1	EPS2	EPS3	EPS4	EPS5	EPS6	EPS7	EPS8
Type	F	F	F	F	F	F	F	F
Default	0	0	0	0	0	0	0	0

Card 4	1	2	3	4	5	6	7	8
Variable	ES1	ES2	ES3	ES4	ES5	ES6	ES7	ES8
Type	F	F	F	F	F	F	F	F
Default	0	0	0	0	0	0	0	0

VARIABLE	DESCRIPTION
MID	Material identification. A unique number or label not exceeding 8 characters must be specified.
RO	Mass density.
E	Young's modulus.
PR	Poisson's ratio.
SIGY	Yield stress.
ETAN	Tangent modulus, ignored if (LCSS.GT.0) is defined.
FAIL	Failure flag. LT.0.0: User defined failure subroutine, matusr_24 in dyn21.F, is called to determine failure EQ.0.0: Failure is not considered. This option is recommended if failure is not of interest since many calculations will be saved. GT.0.0: Effective plastic strain to failure. When the plastic strain reaches this value, the element is deleted from the calculation.
TDEL	Minimum time step size for automatic element deletion.
C	Strain rate parameter, C, see formula below.
P	Strain rate parameter, P, see formula below.

VARIABLE	DESCRIPTION
LCSS	<p>Load curve ID or Table ID (optional; supersedes SIGY, ETAN, EPS1-8, ES1-8). Load curve ID defining effective stress versus effective plastic strain. If defined EPS1-EPS8 and ES1-ES8 are ignored. The table ID defines for each strain rate value a load curve ID giving the stress versus effective plastic strain for that rate, See Figure 2-12. The stress versus effective plastic strain curve for the lowest value of strain rate is used if the strain rate falls below the minimum value. Likewise, the stress versus effective plastic strain curve for the highest value of strain rate is used if the strain rate exceeds the maximum value. The strain rate parameters: C and P; the curve ID, LCSR; EPS1-EPS8 and ES1-ES8 are ignored if a Table ID is defined.</p> <p><u>NOTE:</u> The strain rate values defined in the table may be given as the natural logarithm of the strain rate. If the <i>first</i> stress-strain curve in the table corresponds to a negative strain rate, LS-DYNA assumes that the natural logarithm of the strain rate value is used. Since the tables are internally discretized to equally space the points, natural logarithms are necessary, for example, if the curves correspond to rates from 10.e-04 to 10.e+04. Computing the natural logarithm of the strain rate does slow the stress update down significantly on some computers. Logarithmic interpolation can also be invoked without having to input the natural log of strain rate in the table; this is done simply by adding the LOG_INTERPOLATION option.</p> <p>For the HAZ option, the curve may optionally be specified by a three-dimensional table, making the yield stress a function of the distance from the closest spotweld.</p>

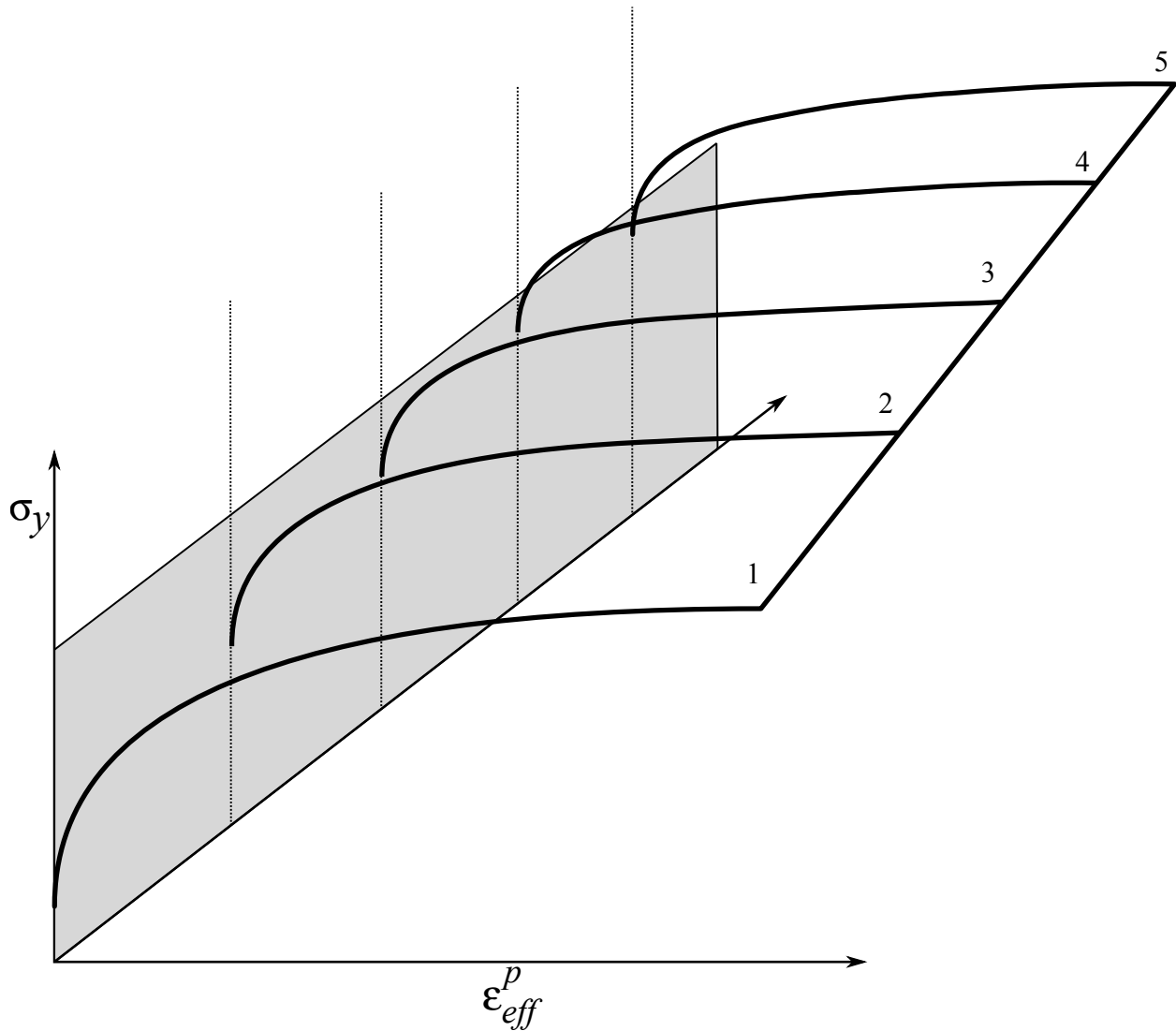

Figure 2-12. Rate effects may be accounted for by defining a table of curves. If a table ID is specified a curve ID is given for each strain rate, see *DEFINE_TABLE. Intermediate values are found by interpolating between curves. Effective plastic strain versus yield stress is expected. If the strain rate values fall out of range, extrapolation is not used; rather, either the first or last curve determines the yield stress depending on whether the rate is low or high, respectively.

VARIABLE	DESCRIPTION
LCSR	Load curve ID defining strain rate scaling effect on yield stress. If LCSR is negative, the load curve is evaluated using a binary search for the correct interval for the strain rate. The binary search is slower than the default incremental search, but in cases where large changes in the strain rate may occur over a single time step, it is more robust. This option is not necessary for the viscoplastic formulation. For the HAZ option, the curve may optionally be specified by a

VARIABLE	DESCRIPTION
	table, making the strain rate scaling a function of the distance from the closest spotweld.
VP	Formulation for rate effects: EQ.-1.0: Cowper-Symonds with deviatoric strain rate rather than total, EQ.0.0: Scale yield stress (default), EQ.1.0: Viscoplastic formulation.
LCF	For the HAZ option only, the equivalent plastic strain for failure may be specified with either a load curve or a table. If LCF is a curve, then the failure strain is given as a function of the strain rate, and if a table is specified, the failure strain is given as a function of the distance from the closest weld and strain rate. If LCF is not specified, FAIL will be used.
EPS1 - EPS8	Effective plastic strain values (optional; supersedes SIGY, ETAN). At least 2 points should be defined. The first point must be zero corresponding to the initial yield stress. WARNING: If the first point is nonzero the yield stress is extrapolated to determine the initial yield. If this option is used SIGY and ETAN are ignored and may be input as zero.
ES1 - ES8	Corresponding yield stress values to EPS1 - EPS8.

Remarks:

The stress strain behavior may be treated by a bilinear stress strain curve by defining the tangent modulus, ETAN. Alternately, a curve of effective stress vs. effective plastic strain similar to that shown in [Figure 2-8](#) may be defined by (EPS1,ES1) - (EPS8,ES8); however, a curve ID (LCSS) may be referenced instead if eight points are insufficient. The cost is roughly the same for either approach. Note that in the special case of uniaxial stress, true stress vs. true plastic strain is equivalent to effective stress vs. effective plastic strain. The most general approach is to use the table definition (LCSS) discussed below.

Three options to account for strain rate effects are possible.

1. Strain rate may be accounted for using the Cowper and Symonds model which scales the yield stress with the factor

$$1 + \left(\frac{\dot{\epsilon}}{C} \right)^{1/p}$$

where $\dot{\epsilon}$ is the strain rate. $\dot{\epsilon} = \sqrt{\dot{\epsilon}_{ij}\dot{\epsilon}_{ij}}$. If VP = -1. The deviatoric strain rates are used instead.

If the viscoplastic option is active, VP = 1.0, and if SIGY is > 0 then the dynamic yield stress is computed from the sum of the static stress, $\sigma_y^s(\epsilon_{\text{eff}}^p)$, which is typically given by a load curve ID, and the initial yield stress, SIGY, multiplied by the Cowper-Symonds rate term as follows:

$$\sigma_y(\epsilon_{\text{eff}}^p, \dot{\epsilon}_{\text{eff}}^p) = \sigma_y^s(\epsilon_{\text{eff}}^p) + \text{SIGY} \times \left(\frac{\dot{\epsilon}_{\text{eff}}^p}{C} \right)^{1/p}$$

where the plastic strain rate is used. With this latter approach similar results can be obtained between this model and material model: *MAT_ANISOTROPIC_VISCOPLASTIC. If SIGY = 0, the following equation is used instead where the static stress, $\sigma_y^s(\epsilon_{\text{eff}}^p)$, must be defined by a load curve:

$$\sigma_y(\epsilon_{\text{eff}}^p, \dot{\epsilon}_{\text{eff}}^p) = \sigma_y^s(\epsilon_{\text{eff}}^p) \left[1 + \left(\frac{\dot{\epsilon}_{\text{eff}}^p}{C} \right)^{1/p} \right]$$

This latter equation is always used if the viscoplastic option is off.

2. For complete generality a load curve (LCSR) to scale the yield stress may be input instead. In this curve the scale factor versus strain rate is defined.
3. If different stress versus strain curves can be provided for various strain rates, the option using the reference to a table (LCSS) can be used. Then the table input in *DEFINE_TABLE has to be used, see [Figure 2-12](#).

A fully viscoplastic formulation is optional (variable VP) which incorporates the different options above within the yield surface. An additional cost is incurred over the simple scaling but the improvement in results can be dramatic.

The HAZ (heat affected zone) option allows the material properties in an element to depend on their distance from the spotweld closest to the element. The shortest distance along the shell surface is calculated to the centroid of each spotweld and the minimum is chosen. LCSS, LCSR, and LCF may be optionally expanded by one dimension to account for the distance from the spotweld. At this time, only solid element spot welds are supported for this feature.

*MAT_GEOLOGIC_CAP_MODEL

This is Material Type 25. This is an inviscid two invariant geologic cap model. This material model can be used for geomechanical problems or for materials as concrete, see references cited below.

Card 1	1	2	3	4	5	6	7	8
Variable	MID	RO	BULK	G	ALPHA	THETA	GAMMA	BETA
Type	A8	F	F	F	F	F	F	F

Card 2	1	2	3	4	5	6	7	8
Variable	R	D	W	X0	C	N		
Type	F	F	F	F	F	F		

Card 3	1	2	3	4	5	6	7	8
Variable	PLOT	FTYPE	VEC	TOFF				
Type	F	F	F	F				

VARIABLE**DESCRIPTION**

MID	Material identification. A unique number or label not exceeding 8 characters must be specified.
RO	Mass density.
BULK	Initial bulk modulus, K.
G	Initial Shear modulus.
ALPHA	Failure envelope parameter, α .
THETA	Failure envelope linear coefficient, θ .
GAMMA	Failure envelope exponential coefficient, γ .

VARIABLE	DESCRIPTION
BETA	Failure envelope exponent, β .
R	Cap, surface axis ratio.
D	Hardening law exponent.
W	Hardening law coefficient.
X0	Hardening law exponent, X_0 .
C	Kinematic hardening coefficient, \bar{c} .
N	Kinematic hardening parameter.
PLOT	<p>Save the following variable for plotting in LS-PrePost, to be labeled there as "effective plastic strain:"</p> <p>EQ.1: hardening parameter, κ</p> <p>EQ.2: cap -J1 axis intercept, $X(\kappa)$</p> <p>EQ.3: volumetric plastic strain ε_v^p</p> <p>EQ.4: first stress invariant, J_1</p> <p>EQ.5: second stress invariant, $\sqrt{J_2}$</p> <p>EQ.6: not used</p> <p>EQ.7: not used</p> <p>EQ.8: response mode number</p> <p>EQ.9: number of iterations</p>
FTYPE	<p>Formulation flag:</p> <p>EQ.1: soils (Cap surface may contract)</p> <p>EQ.2: concrete and rock (Cap doesn't contract)</p>
VEC	<p>Vectorization flag:</p> <p>EQ.0: vectorized (fixed number of iterations)</p> <p>EQ.1: fully iterative</p> <p>If the vectorized solution is chosen, the stresses might be slightly off the yield surface; however, on vector computers a much more efficient solution is achieved.</p>
TOFF	Tension Cut Off, $TOFF < 0$ (positive in compression).

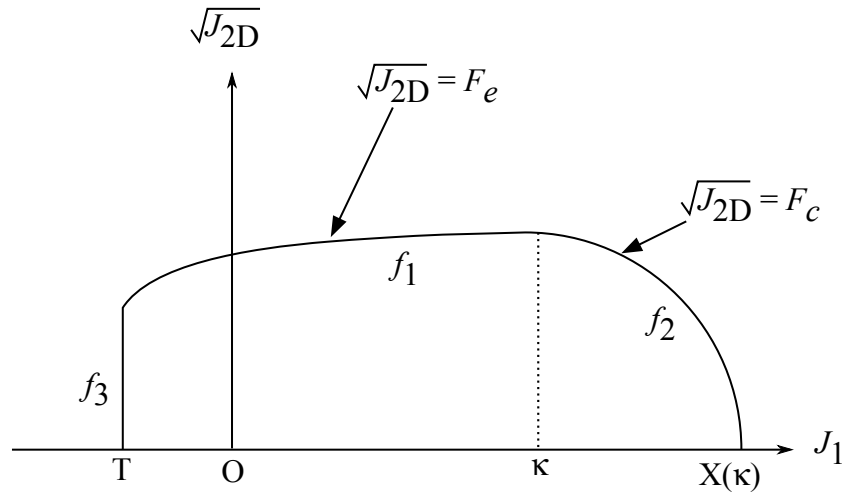

Figure 2-13. The yield surface of the two-invariant cap model in pressure $\sqrt{J_{2D}}$ – J_1 space. Surface f_1 is the failure envelope, f_2 is the cap surface, and f_3 is the tension cutoff.

Remarks:

The implementation of an extended two invariant cap model, suggested by Stojko [1990], is based on the formulations of Simo, et al. [1988, 1990] and Sandler and Rubin [1979]. In this model, the two invariant cap theory is extended to include nonlinear kinematic hardening as suggested by Isenberg, Vaughan, and Sandler [1978]. A brief discussion of the extended cap model and its parameters is given below.

The cap model is formulated in terms of the invariants of the stress tensor. The square root of the second invariant of the deviatoric stress tensor, $\sqrt{J_{2D}}$ is found from the deviatoric stresses s as

$$\sqrt{J_{2D}} \equiv \sqrt{\frac{1}{2} S_{ij} S_{ij}}$$

and is the objective scalar measure of the distortional or shearing stress. The first invariant of the stress, J_1 , is the trace of the stress tensor.

The cap model consists of three surfaces in $\sqrt{J_{2D}} - J_1$ space, as shown in [Figure 2-13](#). First, there is a failure envelope surface, denoted f_1 in the figure. The functional form of f_1 is

$$f_1 = \sqrt{J_{2D}} - \min[F_e(J_1), T_{mises}],$$

where F_e is given by

$$F_e(J_1) \equiv \alpha - \gamma \exp(-\beta J_1) + \theta J_1$$

and $T_{mises} \equiv |X(\kappa_n) - L(\kappa_n)|$. This failure envelop surface is fixed in $\sqrt{J_{2D}} - J_1$ space, and therefore does not harden unless kinematic hardening is present. Next, there is a cap surface, denoted f_2 in the figure, with f_2 given by

$$f_2 = \sqrt{J_{2D}} - F_c(J_1, K)$$

where F_c is defined by

$$F_c(J_1, \kappa) \equiv \frac{1}{R} \sqrt{[X(\kappa) - L(\kappa)]^2 - [J_1 - L(\kappa)]^2},$$

$X(\kappa)$ is the intersection of the cap surface with the J_1 axis

$$X(\kappa) = \kappa + RF_e(\kappa),$$

and $L(\kappa)$ is defined by

$$L(\kappa) \equiv \begin{cases} \kappa & \text{if } \kappa > 0 \\ 0 & \text{if } \kappa \leq 0 \end{cases}$$

The hardening parameter κ is related to the plastic volume change ε_v^p through the hardening law

$$\varepsilon_v^p = W\{1 - \exp[-D(X(\kappa) - X_0)]\}$$

Geometrically, κ is seen in the figure as the J_1 coordinate of the intersection of the cap surface and the failure surface. Finally, there is the tension cutoff surface, denoted f_3 in the figure. The function f_3 is given by

$$f_3 \equiv T - J_1$$

where T is the input material parameter which specifies the maximum hydrostatic tension sustainable by the material. The elastic domain in $\sqrt{J_{2D}} - J_1$ space is then bounded by the failure envelope surface above, the tension cutoff surface on the left, and the cap surface on the right.

An additive decomposition of the strain into elastic and plastic parts is assumed:

$$\varepsilon = \varepsilon^e + \varepsilon^p,$$

where ε^e is the elastic strain and ε^p is the plastic strain. Stress is found from the elastic strain using Hooke's law,

$$\sigma = \mathbf{C}(\varepsilon - \varepsilon^p),$$

where σ is the stress and \mathbf{C} is the elastic constitutive tensor.

The yield condition may be written

$$f_1(s) \leq 0$$

$$f_2(s, \kappa) \leq 0$$

$$f_3(s) \leq 0$$

and the plastic consistency condition requires that

$$\dot{\lambda}_k f_k = 0$$

$$k = 1,2,3$$

$$\dot{\lambda}_k \geq 0$$

where λ_k is the plastic consistency parameter for surface k. If $f_k < 0$ then, $\dot{\lambda}_k = 0$ and the response is elastic. If $f_k > 0$ then surface k is active and $\dot{\lambda}_k$ is found from the requirement that $\dot{f}_k = 0$.

Associated plastic flow is assumed, so using Koiter's flow rule the plastic strain rate is given as the sum of contribution from all of the active surfaces,

$$\dot{\epsilon}^p = \sum_{k=1}^3 \dot{\lambda}_k \frac{\partial f_k}{\partial s}$$

One of the major advantages of the cap model over other classical pressure-dependent plasticity models is the ability to control the amount of dilatancy produced under shear loading. Dilatancy is produced under shear loading as a result of the yield surface having a positive slope in $\sqrt{J_{2D}} - J$ space, so the assumption of plastic flow in the direction normal to the yield surface produces a plastic strain rate vector that has a component in the volumetric (hydrostatic) direction (see [Figure 2-13](#)). In models such as the Drucker-Prager and Mohr-Coulomb, this dilatancy continues as long as shear loads are applied, and in many cases produces far more dilatancy than is experimentally observed in material tests. In the cap model, when the failure surface is active, dilatancy is produced just as with the Drucker-Prager and Mohr-Coulomb models. However, the hardening law permits the cap surface to contract until the cap intersects the failure envelope at the stress point, and the cap remains at that point. The local normal to the yield surface is now vertical, and therefore the normality rule assures that no further plastic volumetric strain (dilatancy) is created. Adjustment of the parameters that control the rate of cap contractions permits experimentally observed amounts of dilatancy to be incorporated into the cap model, thus producing a constitutive law which better represents the physics to be modeled.

Another advantage of the cap model over other models such as the Drucker-Prager and Mohr-Coulomb is the ability to model plastic compaction. In these models all purely volumetric response is elastic. In the cap model, volumetric response is elastic until the stress point hits the cap surface. Therefore, plastic volumetric strain (compaction) is generated at a rate controlled by the hardening law. Thus, in addition to controlling the amount of dilatancy, the introduction of the cap surface adds another experimentally observed response characteristic of geological material into the model.

The inclusion of kinematic hardening results in hysteretic energy dissipation under cyclic loading conditions. Following the approach of Isenberg, et al. [1978] a nonlinear kinematic hardening law is used for the failure envelope surface when nonzero values of α and N are specified. In this case, the failure envelope surface is replaced by a family of yield surfaces bounded by an initial yield surface and a limiting failure envelope surface. Thus, the shape of the yield surfaces described above remains unchanged, but they may translate in a plane orthogonal to the J axis,

Translation of the yield surfaces is permitted through the introduction of a “back stress” tensor, α . The formulation including kinematic hardening is obtained by replacing the stress σ with the translated stress tensor $\eta \equiv \sigma - \alpha$ in all of the above equation. The history tensor α is assumed deviatoric, and therefore has only 5 unique components. The evolution of the back stress tensor is governed by the nonlinear hardening law

$$\alpha = \bar{c}\bar{F}(\sigma, \alpha)e^p$$

where \bar{c} is a constant, \bar{F} is a scalar function of σ and α and e^p is the rate of deviatoric plastic strain. The constant may be estimated from the slope of the shear stress - plastic shear strain curve at low levels of shear stress.

The function \bar{F} is defined as

$$\bar{F} \equiv \max \left[0, 1 - \frac{(\sigma - \alpha)\alpha}{2NF_e(J_1)} \right]$$

where N is a constant defining the size of the yield surface. The value of N may be interpreted as the radial distance between the outside of the initial yield surface and the inside of the limit surface. In order for the limit surface of the kinematic hardening cap model to correspond with the failure envelope surface of the standard cap model, the scalar parameter α must be replaced $\alpha - N$ in the definition F_e .

The cap model contains a number of parameters which must be chosen to represent a particular material, and are generally based on experimental data. The parameters α , β , θ , and γ are usually evaluated by fitting a curve through failure data taken from a set of triaxial compression tests. The parameters W, D, and X_0 define the cap hardening law. The value W represents the void fraction of the uncompressed sample and D governs the slope of the initial loading curve in hydrostatic compression. The value of R is the ration of major to minor axes of the quarter ellipse defining the cap surface. Additional details and guidelines for fitting the cap model to experimental data are found in Chen and Baladi [1985].

***MAT_HONEYCOMB**

This is Material Type 26. The major use of this material model is for honeycomb and foam materials with real anisotropic behavior. A nonlinear elastoplastic material behavior can be defined separately for all normal and shear stresses. These are considered to be fully uncoupled. See notes below.

Card 1	1	2	3	4	5	6	7	8
Variable	MID	RO	E	PR	SIGY	VF	MU	BULK
Type	A8	F	F	F	F	F	F	F
Default	none	none	none	none	none	none	.05	0.0

Card 2	1	2	3	4	5	6	7	8
Variable	LCA	LCB	LCC	LCS	LCAB	LCBC	LCCA	LCSR
Type	F	F	F	F	F	F	F	F
Default	none	LCA	LCA	LCA	LCS	LCS	LCS	optional

Card 3	1	2	3	4	5	6	7	8
Variable	EAAU	EBBU	ECCU	GABU	GBCU	GCAU	AOPT	MACF
Type	F	F	F	F	F	F		I

Card 4	1	2	3	4	5	6	7	8
Variable	XP	YP	ZP	A1	A2	A3		
Type	F	F	F	F	F	F		

Card 5	1	2	3	4	5	6	7	8
Variable	D1	D2	D3	TSEF	SSEF	V1	V2	V3
Type	F	F	F	F	F	F	F	F

VARIABLE**DESCRIPTION**

MID	Material identification. A unique number or label not exceeding 8 characters must be specified.
RO	Mass density.
E	Young's modulus for compacted honeycomb material.
PR	Poisson's ratio for compacted honeycomb material.
SIGY	Yield stress for fully compacted honeycomb.
VF	Relative volume at which the honeycomb is fully compacted.
MU	μ , material viscosity coefficient. (default=.05) Recommended.
BULK	Bulk viscosity flag: EQ.0.0: bulk viscosity is not used. This is recommended. EQ.1.0: bulk viscosity is active and $\mu = 0$. This will give results identical to previous versions of LS-DYNA.
LCA	Load curve ID, see *DEFINE_CURVE, for sigma-aa versus either relative volume or volumetric strain. See notes below.
LCB	Load curve ID, see *DEFINE_CURVE, for sigma-bb versus either relative volume or volumetric strain. Default LCB = LCA. See notes below.
LCC	Load curve ID, see *DEFINE_CURVE, for sigma-cc versus either relative volume or volumetric strain. Default LCC = LCA. See notes below.
LCS	Load curve ID, see *DEFINE_CURVE, for shear stress versus either relative volume or volumetric strain. Default LCS = LCA. Each component of shear stress may have its own load curve. See notes below.

VARIABLE	DESCRIPTION
LCAB	Load curve ID, see *DEFINE_CURVE, for sigma-ab versus either relative volume or volumetric strain. Default LCAB = LCS. See notes below.
LCBC	Load curve ID, see *DEFINE_CURVE, for sigma-bc versus either relative volume or volumetric strain. Default LCBC = LCS. See notes below.
LCCA	Load curve ID, see *DEFINE_CURVE, or sigma-ca versus either relative volume or volumetric strain. Default LCCA = LCS. See notes below.
LCSR	Load curve ID, see *DEFINE_CURVE, for strain-rate effects defining the scale factor versus strain rate. This is optional. The curves defined above are scaled using this curve.
EAAU	Elastic modulus E_{aaU} in uncompressed configuration.
EBBU	Elastic modulus E_{bbU} in uncompressed configuration.
ECCU	Elastic modulus E_{ccU} in uncompressed configuration.
GABU	Shear modulus G_{abU} in uncompressed configuration.
GBCU	Shear modulus G_{bcU} in uncompressed configuration.
GCAU	Shear modulus G_{caU} in uncompressed configuration.
AOPT	Material axes option (see MAT_OPTIONTROPIC_ELASTIC for a more complete description): <ul style="list-style-type: none"> EQ.0.0: locally orthotropic with material axes determined by element nodes 1, 2, and 4, as with *DEFINE_COORDINATE_NODES. EQ.1.0: locally orthotropic with material axes determined by a point in space and the global location of the element center; this is the a-direction. EQ.2.0: globally orthotropic with material axes determined by vectors defined below, as with *DEFINE_COORDINATE_VECTOR EQ.3.0: locally orthotropic material axes determined by rotating the material axes about the element normal by an angle, BETA, from a line in the plane of the element defined by the cross product of the vector v with the element nor-

VARIABLE	DESCRIPTION
	<p>mal. The plane of a solid element is the midsurface between the inner surface and outer surface defined by the first four nodes and the last four nodes of the connectivity of the element, respectively.</p> <p>EQ.4.0: locally orthotropic in cylindrical coordinate system with the material axes determined by a vector \mathbf{v}, and an originating point, p, which define the centerline axis. This option is for solid elements only.</p> <p>LT.0.0: the absolute value of AOPT is a coordinate system ID number (CID on *DEFINE_COORDINATE_NODES, *DEFINE_COORDINATE_SYSTEM or *DEFINE_COORDINATE_VECTOR). Available in R3 version of 971 and later..</p>
MACF	<p>Material axes change flag:</p> <p>EQ.1: No change, default,</p> <p>EQ.2: switch material axes a and b,</p> <p>EQ.3: switch material axes a and c,</p> <p>EQ.4: switch material axes b and c.</p>
XP YP ZP	Coordinates of point \mathbf{p} for AOPT = 1 and 4.
A1 A2 A3	Components of vector \mathbf{a} for AOPT = 2.
D1 D2 D3	Components of vector \mathbf{d} for AOPT = 2.
V1 V2 V3	Define components of vector \mathbf{v} for AOPT = 3 and 4.
TSEF	Tensile strain at element failure (element will erode).
SSEF	Shear strain at element failure (element will erode).

Remarks:

For efficiency it is strongly recommended that the load curve ID's: LCA, LCB, LCC, LCS, LCAB, LCBC, and LCCA, contain exactly the same number of points with corresponding strain values on the abscissa. If this recommendation is followed the cost of the table lookup is insignificant. Conversely, the cost increases significantly if the abscissa strain values are not consistent between load curves.

The behavior before compaction is orthotropic where the components of the stress tensor are uncoupled, i.e., an a component of strain will generate resistance in the local a -direction with no coupling to the local b and c directions. The elastic moduli vary, from their initial values to the fully compacted values at V_f , linearly with the relative volume V :

$$E_{aa} = E_{aa0} + \beta(E - E_{aa0})$$

$$E_{bb} = E_{bb0} + \beta(E - E_{bb0})$$

$$E_{cc} = E_{cc0} + \beta(E - E_{cc0})$$

$$G_{ab} = G_{ab0} + \beta(G - G_{ab0})$$

$$G_{bc} = G_{bc0} + \beta(G - G_{bc0})$$

$$G_{ca} = G_{ca0} + \beta(G - G_{ca0})$$

where

$$\beta = \max \left[\min \left(\frac{1 - V}{1 - V_f}, 1 \right), 0 \right]$$

and G is the elastic shear modulus for the fully compacted honeycomb material

$$G = \frac{E}{2(1 + \nu)}$$

The relative volume, V , is defined as the ratio of the current volume to the initial volume. Typically, $V = 1$ at the beginning of a calculation. The viscosity coefficient μ (MU) should be set to a small number (usually .02 - .10 is okay). Alternatively, the two bulk viscosity coefficients on the control cards should be set to very small numbers to prevent the development of spurious pressures that may lead to undesirable and confusing results. The latter is not recommended since spurious numerical noise may develop.

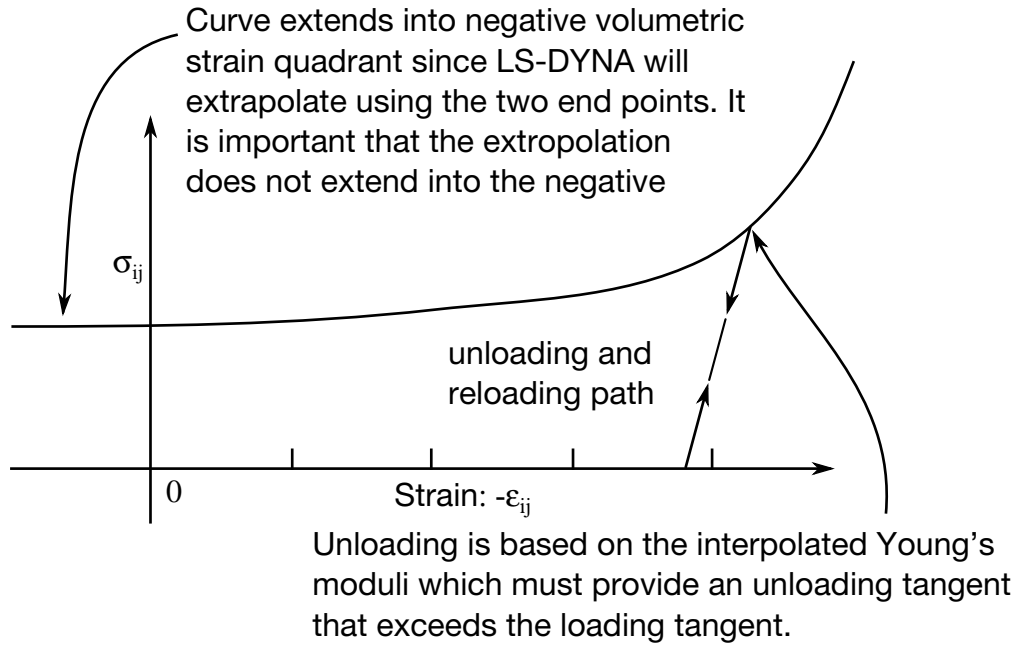

Figure 2-14. Stress quantity versus volumetric strain. Note that the “yield stress” at a volumetric strain of zero is non-zero. In the load curve definition, see *DEFINE_CURVE, the “time” value is the volumetric strain and the “function” value is the yield stress.

The load curves define the magnitude of the average stress as the material changes density (relative volume), see [Figure 2-14](#). Each curve related to this model must have the same number of points and the same abscissa values. There are two ways to define these curves, **a**) as a function of relative volume (V) or **b**) as a function of volumetric strain defined as:

$$\epsilon_V = 1 - V$$

In the former, the first value in the curve should correspond to a value of relative volume slightly less than the fully compacted value. In the latter, the first value in the curve should be less than or equal to zero, corresponding to tension, and increase to full compaction. **Care should be taken when defining the curves so that extrapolated values do not lead to negative yield stresses.**

At the beginning of the stress update each element's stresses and strain rates are transformed into the local element coordinate system. For the uncompacted material, the trial stress components are updated using the elastic interpolated moduli according to:

$$\begin{aligned} \sigma_{aa}^{n+1\text{trial}} &= \sigma_{aa}^n + E_{aa}\Delta\epsilon_{aa} \\ \sigma_{bb}^{n+1\text{trial}} &= \sigma_{bb}^n + E_{bb}\Delta\epsilon_{bb} \\ \sigma_{cc}^{n+1\text{trial}} &= \sigma_{cc}^n + E_{cc}\Delta\epsilon_{cc} \\ \sigma_{ab}^{n+1\text{trial}} &= \sigma_{ab}^n + 2G_{ab}\Delta\epsilon_{ab} \\ \sigma_{bc}^{n+1\text{trial}} &= \sigma_{bc}^n + 2G_{bc}\Delta\epsilon_{bc} \end{aligned}$$

$$\sigma_{ca}^{n+1\text{trial}} = \sigma_{ca}^n + 2G_{ca}\Delta\varepsilon_{ca}$$

Each component of the updated stresses is then independently checked to ensure that they do not exceed the permissible values determined from the load curves; e.g., if

$$\left| \sigma_{ij}^{n+1\text{trial}} \right| > \lambda \sigma_{ij}(V)$$

then

$$\sigma_{ij}^{n+1} = \sigma_{ij}(V) \frac{\lambda \sigma_{ij}^{n+1\text{trial}}}{\left| \lambda \sigma_{ij}^{n+1\text{trial}} \right|}$$

On Card 2 $\sigma_{ij}(V)$ is defined by LCA for the aa stress component, LCB for the bb component, LCC for the cc component, and LCS for the ab, bc, ca shear stress components. The parameter λ is either unity or a value taken from the load curve number, LCSR, that defines λ as a function of strain-rate. Strain-rate is defined here as the Euclidean norm of the deviatoric strain-rate tensor.

For fully compacted material it is assumed that the material behavior is elastic-perfectly plastic and the stress components updated according to:

$$s_{ij}^{\text{trial}} = s_{ij}^n + 2G\Delta\varepsilon_{ij}^{\text{dev}}{}^{n+1/2}$$

where the deviatoric strain increment is defined as

$$\Delta\varepsilon_{ij}^{\text{dev}} = \Delta\varepsilon_{ij} - \frac{1}{3}\Delta\varepsilon_{kk}\delta_{ij}$$

Now a check is made to see if the yield stress for the fully compacted material is exceeded by comparing

$$s_{\text{eff}}^{\text{trial}} = \left(\frac{3}{2} s_{ij}^{\text{trial}} s_{ij}^{\text{trial}} \right)^{1/2}$$

the effective trial stress to the defined yield stress, SIGY. If the effective trial stress exceeds the yield stress the stress components are simply scaled back to the yield surface

$$s_{ij}^{n+1} = \frac{\sigma_y}{s_{\text{eff}}^{\text{trial}}} s_{ij}^{\text{trial}}.$$

Now the pressure is updated using the elastic bulk modulus, K

$$p^{n+1} = p^n - K\Delta\varepsilon_{kk}{}^{n+1/2}$$

where

$$K = \frac{E}{3(1-2\nu)}$$

to obtain the final value for the Cauchy stress

$$\sigma_{ij}^{n+1} = s_{ij}^{n+1} - p^{n+1}\delta_{ij}$$

After completing the stress update transform the stresses back to the global configuration.

For `*CONSTRAINED_TIED_NODES_WITH_FAILURE`, the failure is based on the volume strain instead to the plastic strain.

*MAT_MOONEYRIVLIN_RUBBER

This is Material Type 27. A two-parametric material model for rubber can be defined.

Card 1	1	2	3	4	5	6	7	8
Variable	MID	RO	PR	A	B	REF		
Type	A8	F	F	F	F	F		

Card 2	1	2	3	4	5	6	7	8
Variable	SGL	SW	ST	LCID				
Type	F	F	F	F				

<u>VARIABLE</u>	<u>DESCRIPTION</u>
MID	Material identification. A unique number or label not exceeding 8 characters must be specified.
RO	Mass density.
PR	Poisson’s ratio (value between 0.49 and 0.5 is recommended, smaller values may not work).
A	Constant, see literature and equations defined below.
B	Constant, see literature and equations defined below.
REF	Use reference geometry to initialize the stress tensor. The reference geometry is defined by the keyword:*INITIAL_FOAM_REFERENCE_GEOMETRY (see there for more details). EQ.0.0: off, EQ.1.0: on.

If A = B=0.0, then a least square fit is computed from tabulated uniaxial data via a load curve. The following information should be defined

SGL	Specimen gauge length l_0 , see Figure 2-15 .
SW	Specimen width, see Figure 2-15 .

VARIABLE	DESCRIPTION
ST	Specimen thickness, see Figure 2-15 .
LCID	Load curve ID, see *DEFINE_CURVE, giving the force versus actual change ΔL in the gauge length. See also Figure 2-16 for an alternative definition.

Remarks:

The strain energy density function is defined as:

$$W = A(I - 3) + B(II - 3) + C(III^{-2} - 1) + D(III - 1)^2$$

where

$$C = 0.5 A + B$$

$$D = \frac{A(5\nu - 2) + B(11\nu - 5)}{2(1 - 2\nu)}$$

$$\nu = \text{Poisson's ratio}$$

$$2(A + B) = \text{shear modulus of linear elasticity}$$

$$I, II, III = \text{invariants of right Cauchy-Green Tensor } C.$$

The load curve definition that provides the uniaxial data should give the change in gauge length, ΔL , versus the corresponding force. In compression both the force and the change in gauge length must be specified as negative values. In tension the force and change in gauge length should be input as positive values. The principal stretch ratio in the uniaxial direction, λ_1 , is then given by

$$\lambda_1 = \frac{L_0 + \Delta L}{L_0}$$

with L_0 being the initial length and L being the actual length.

Alternatively, the stress versus strain curve can also be input by setting the gauge length, thickness, and width to unity (1.0) and defining the engineering strain in place of the change in gauge length and the nominal (engineering) stress in place of the force, see [Figure 2-15](#).

The least square fit to the experimental data is performed during the initialization phase and is a comparison between the fit and the actual input is provided in the d3hsp file. It is a good idea to visually check to make sure it is acceptable. The coefficients A and B are also printed in the output file. It is also advised to use the material driver (see Appendix K) for checking out the material model.

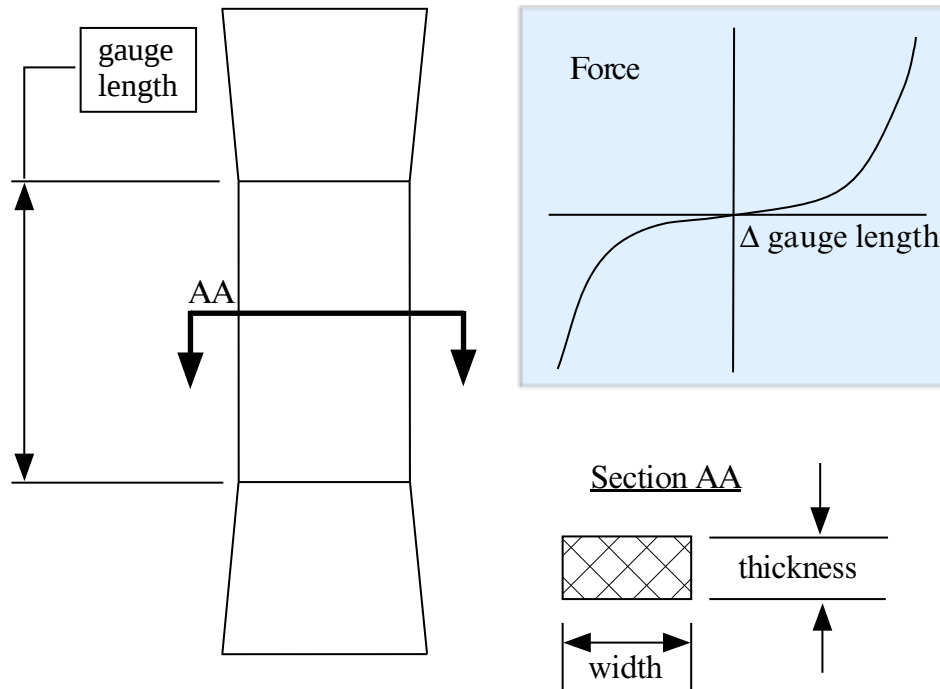

Figure 2-15. Uniaxial specimen for experimental data

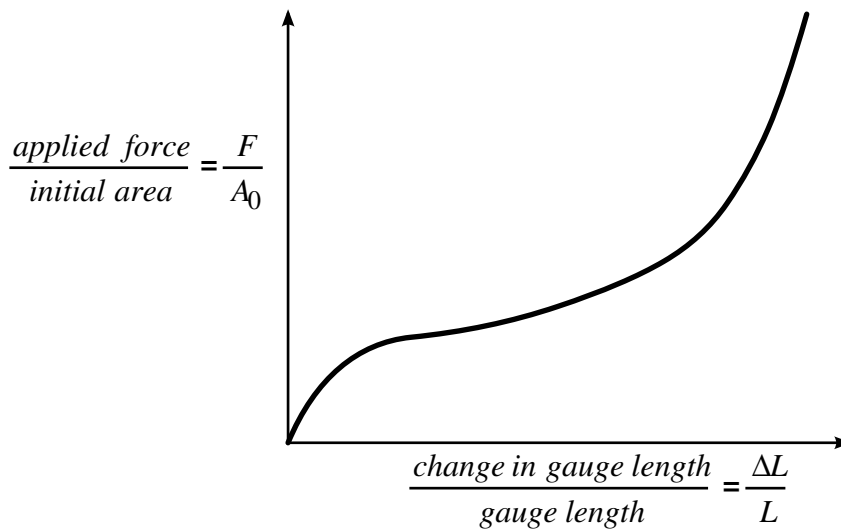

Figure 2-16 The stress versus strain curve can be used instead of the force versus the change in the gauge length by setting the gauge length, thickness, and width to unity (1.0) and defining the engineering strain in place of the change in gauge length and the nominal (engineering) stress in place of the force. *MAT_077_O is a better alternative for fitting data resembling the curve above. *MAT_027 will provide a poor fit to a curve that exhibits an strong upturn in slope as strains become large.

***MAT_RESULTANT_PLASTICITY**

This is Material Type 28. A resultant formulation for beam and shell elements including elasto-plastic behavior can be defined. This model is available for the Belytschko-Schwer beam, the C⁰ triangular shell, the Belytschko-Tsay shell, and the fully integrated type 16 shell. For beams, the treatment is elastic-perfectly plastic, but for shell elements isotropic hardening is approximately modeled. For a detailed description we refer to the LS-DYNA Theory Manual. Since the stresses are not computed in the resultant formulation, the stresses output to the binary databases for the resultant elements are zero.

Card 1	1	2	3	4	5	6	7	8
Variable	MID	RO	E	PR	SIGY	ETAN		
Type	A8	F	F	F	F	F		
Default	none	none	none	none	none	0.0		

VARIABLE**DESCRIPTION**

MID	Material identification. A unique number or label not exceeding 8 characters must be specified.
RO	Mass density
E	Young's modulus
PR	Poisson's ratio
SIGY	Yield stress
ETAN	Plastic hardening modulus (for shells only)

***MAT_FORCE_LIMITED**

This is Material Type 29. With this material model, for the Belytschko-Schwer beam only, plastic hinge forming at the ends of a beam can be modeled using curve definitions. Optionally, collapse can also be modeled. See also *MAT_139.

Description: FORCE LIMITED Resultant Formulation

Card 1	1	2	3	4	5	6	7	8
Variable	MID	RO	E	PR	DF	AOPT	YTFLAG	ASOFT
Type	A8	F	F	F	F	F	F	F
Default	none	none	none	none	0.0	0.0	0.0	0.0

Card 2	1	2	3	4	5	6	7	8
Variable	M1	M2	M3	M4	M5	M6	M7	M8
Type	F	F	F	F	F	F	F	F
Default	none	0	0	0	0	0	0	0

Card 3	1	2	3	4	5	6	7	8
Variable	LC1	LC2	LC3	LC4	LC5	LC6	LC7	LC8
Type	F	F	F	F	F	F	F	F
Default	none	0	0	0	0	0	0	0

Card 4	1	2	3	4	5	6	7	8
Variable	LPS1	SFS1	LPS2	SFS2	YMS1	YMS2		
Type	F	F	F	F	F	F		
Default	0	1.0	LPS1	1.0	1.0E+20	YMS1		

Card 5	1	2	3	4	5	6	7	8
Variable	LPT1	SFT1	LPT2	SFT2	YMT1	YMT2		
Type	F	F	F	F	F	F		
Default	0	1.0	LPT1	1.0	1.0E+20	YMT1		

Card 6	1	2	3	4	5	6	7	8
Variable	LPR	SFR	YMR					
Type	F	F	F					
Default	0	1.0	1.0E+20					

VARIABLE**DESCRIPTION**

MID	Material identification. A unique number or label not exceeding 8 characters must be specified.
RO	Mass density
E	Young's modulus
PR	Poisson's ratio
DF	Damping factor, see definition in notes below. A proper control for the timestep has to be maintained by the user!

VARIABLE	DESCRIPTION
AOPT	Axial load curve option: EQ.0.0: axial load curves are force versus strain, EQ.1.0: axial load curves are force versus change in length. LT.0.0: the absolute value of AOPT is a coordinate system ID number (CID on *DEFINE_COORDINATE_NODES, *DEFINE_COORDINATE_SYSTEM or *DEFINE_COORDINATE_VECTOR). Available in R3 version of 971 and later.
YTFLAG	Flag to allow beam to yield in tension: EQ.0.0: beam does not yield in tension, EQ.1.0: beam can yield in tension.
ASOFT	Axial elastic softening factor applied once hinge has formed. When a hinge has formed the stiffness is reduced by this factor. If zero, this factor is ignored.
M1, M2, ..., M8	Applied end moment for force versus (strain/change in length) curve. At least one must be defined. A maximum of 8 moments can be defined. The values should be in ascending order.
LC1, LC2, ..., LC8	Load curve ID (see *DEFINE_CURVE) defining axial force (collapse load) versus strain/change in length (see AOPT) for the corresponding applied end moment. Define the same number as end moments. Each curve must contain the same number of points.
LPS1	Load curve ID for plastic moment versus rotation about s-axis at node 1. If zero, this load curve is ignored.
SFS1	Scale factor for plastic moment versus rotation curve about s-axis at node 1. Default = 1.0.
LPS2	Load curve ID for plastic moment versus rotation about s-axis at node 2. Default: is same as at node 1.
SFS2	Scale factor for plastic moment versus rotation curve about s-axis at node 2. Default: is same as at node 1.
YMS1	Yield moment about s-axis at node 1 for interaction calculations (default set to 1.0E+20 to prevent interaction).

VARIABLE	DESCRIPTION
YMS2	Yield moment about s-axis at node 2 for interaction calculations (default set to YMS1).
LPT1	Load curve ID for plastic moment versus rotation about t-axis at node 1. If zero, this load curve is ignored.
SFT1	Scale factor for plastic moment versus rotation curve about t-axis at node 1. Default = 1.0.
LPT2	Load curve ID for plastic moment versus rotation about t-axis at node 2. Default: is the same as at node 1.
SFT2	Scale factor for plastic moment versus rotation curve about t-axis at node 2. Default: is the same as at node 1.
YMT1	Yield moment about t-axis at node 1 for interaction calculations (default set to 1.0E+20 to prevent interactions)
YMT2	Yield moment about t-axis at node 2 for interaction calculations (default set to YMT1)
LPR	Load curve ID for plastic torsional moment versus rotation. If zero, this load curve is ignored.
SFR	Scale factor for plastic torsional moment versus rotation (default = 1.0).
YMR	Torsional yield moment for interaction calculations (default set to 1.0E+20 to prevent interaction)

Remarks:

This material model is available for the Belytschko resultant beam element only. Plastic hinges form at the ends of the beam when the moment reaches the plastic moment. The moment versus rotation relationship is specified by the user in the form of a load curve and scale factor. The points of the load curve are (plastic rotation in radians, plastic moment). Both quantities should be positive for all points, with the first point being (zero, initial plastic moment). Within this constraint any form of characteristic may be used, including flat or falling curves. Different load curves and scale factors may be specified at each node and about each of the local s and t axes.

Axial collapse occurs when the compressive axial load reaches the collapse load. Collapse load versus collapse deflection is specified in the form of a load curve. The points of the load curve are either (true strain, collapse force) or (change in length, collapse force). Both

quantities should be entered as positive for all points, and will be interpreted as compressive. The first point should be (zero, initial collapse load).

The collapse load may vary with end moment as well as with deflections. In this case several load-deflection curves are defined, each corresponding to a different end moment. Each load curve should have the same number of points and the same deflection values. The end moment is defined as the average of the absolute moments at each end of the beam and is always positive.

Stiffness-proportional damping may be added using the damping factor λ . This is defined as follows:

$$\lambda = \frac{2 \times \zeta}{\omega}$$

where ζ is the damping factor at the reference frequency ω (in radians per second). For example if 1% damping at 2Hz is required

$$\lambda = \frac{2 \times 0.01}{2\pi \times 2} = 0.001592$$

If damping is used, a small timestep may be required. LS-DYNA does not check this so to avoid instability it may be necessary to control the timestep via a load curve. As a guide, the timestep required for any given element is multiplied by $0.3L/c\lambda$ when damping is present (L = element length, c = sound speed).

Moment Interaction:

Plastic hinges can form due to the combined action of moments about the three axes. This facility is activated only when yield moments are defined in the material input. A hinge forms when the following condition is first satisfied.

$$\left(\frac{M_r}{M_{r\text{yield}}}\right)^2 + \left(\frac{M_s}{M_{s\text{yield}}}\right)^2 + \left(\frac{M_t}{M_{t\text{yield}}}\right)^2 \geq 1$$

where,

M_r, M_s, M_t , = current moment

$M_{r\text{yield}}, M_{s\text{yield}}, M_{t\text{yield}}$ = yield moment

Note that scale factors for hinge behavior defined in the input will also be applied to the yield moments: for example, $M_{s\text{yield}}$ in the above formula is given by the input yield moment about the local axis times the input scale factor for the local s axis. For strain-softening characteristics, the yield moment should generally be set equal to the initial peak of the moment-rotation load curve.

On forming a hinge, upper limit moments are set. These are given by

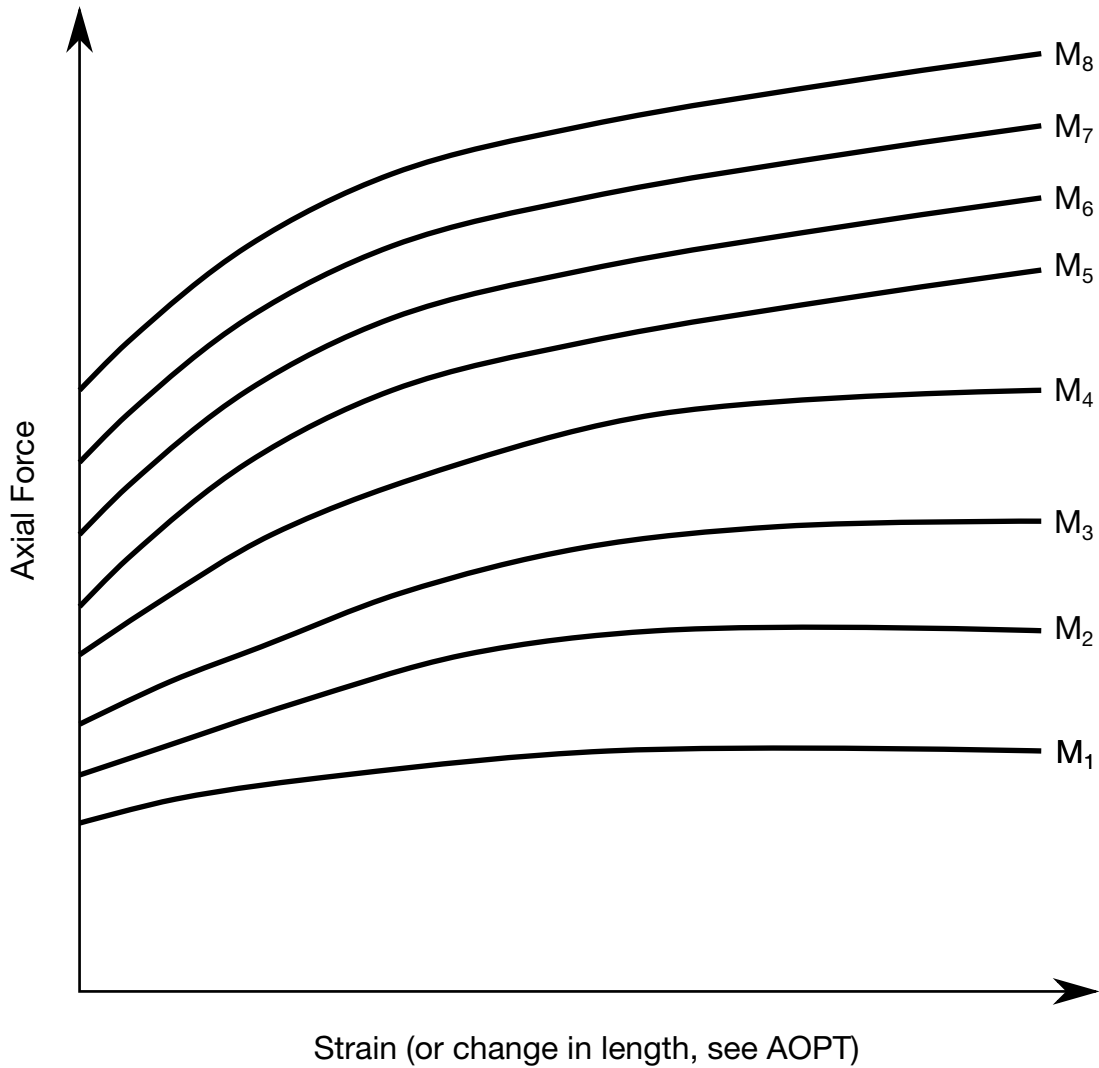

Figure 2-17. The force magnitude is limited by the applied end moment. For an intermediate value of the end moment LS-DYNA interpolates between the curves to determine the allowable force value.)

$$M_{r\text{upper}} = \max\left(M_r, \frac{M_{r\text{yield}}}{2}\right)$$

and similar conditions hold for $M_{s\text{upper}}$ and $M_{t\text{upper}}$.

Thereafter, the plastic moments will be given by

$$M_{rp} = \min(M_{r\text{upper}}, M_{r\text{curve}})$$

where,

M_{rp} = current plastic moment

$M_{r\text{curve}}$ = moment from load curve at the current rotation scaled by the scale factor.

M_{s_p} and M_{t_p} satisfy similar conditions.

The effect of this is to provide an upper limit to the moment that can be generated; it represents the softening effect of local buckling at a hinge site. Thus if a member is bent about its local s-axis it will then be weaker in torsion and about its local t-axis. For moment-softening curves, the effect is to trim off the initial peak (although if the curves subsequently harden, the final hardening will also be trimmed off).

It is not possible to make the plastic moment vary with axial load.

***MAT_SHAPE_MEMORY**

This is material type 30. This material model describes the superelastic response present in shape-memory alloys (SMA), that is the peculiar material ability to undergo large deformations with a full recovery in loading-unloading cycles (See [Figure 2-18](#)). The material response is always characterized by a hysteresis loop. See the references by Auricchio, Taylor and Lubliner [1997] and Auricchio and Taylor [1997]. This model is available for shells, solids, and Hughes-Liu beam elements.

Card 1	1	2	3	4	5	6	7	8
Variable	MID	RO	E	PR				
Type	A8	F	F	F				
Default	none	none	none	none				

Card 2	1	2	3	4	5	6	7	8
Variable	SIG_ASS	SIG_ASF	SIG_SAS	SIG_SAF	EPSL	ALPHA	YMRT	
Type	F	F	F	F	F	F	F	
Default	none	none	none	none	none	0.0	0.0	

Optional Card 3

Card 3	1	2	3	4	5	6	7	8
Variable	LCID_AS	LCID_SA						
Type	I	I						
Default	none	none						

VARIABLE**DESCRIPTION**

MID

Material identification. A unique number or label not exceeding 8 characters must be specified.

VARIABLE	DESCRIPTION
RO	Density
E	Young's modulus
PR	Poisson's ratio
SIG_ASS	Starting value for the forward phase transformation (conversion of austenite into martensite) in the case of a uniaxial tensile state of stress. A load curve for SIG_ASS as a function of temperature is specified by using the negative of the load curve ID number.
SIG_ASF	Final value for the forward phase transformation (conversion of austenite into martensite) in the case of a uniaxial tensile state of stress. SIG_ASF as a function of temperature is specified by using the negative of the load curve ID number.
SIG_SAS	Starting value for the reverse phase transformation (conversion of martensite into austenite) in the case of a uniaxial tensile state of stress. SIG_SAS as a function of temperature is specified by using the negative of the load curve ID number.
SIG_SAF	Final value for the reverse phase transformation (conversion of martensite into austenite) in the case of a uniaxial tensile state of stress. SIG_SAF as a function of temperature is specified by using the negative of the load curve ID number.
EPSL	Recoverable strain or maximum residual strain. It is a measure of the maximum deformation obtainable all the martensite in one direction.
ALPHA	Parameter measuring the difference between material responses in tension and compression (set alpha = 0 for no difference). Also, see the following Remark.
YMRT	Young's modulus for the martensite if it is different from the modulus for the austenite. Defaults to the austenite modulus if it is set to zero.

VARIABLE	DESCRIPTION
LCID_AS	<p>Load curve ID or Table ID for forward phase change (conversion of austenite into martensite). Load curve ID defining effective stress versus martensite fraction (ranging from 0 to 1). The table ID defines for each rate of the martensite fraction a load curve ID giving the stress versus martensite fraction for that phase transition rate. The stress versus martensite fraction curve for the lowest value of the phase transition rate is used if the phase transition rate falls below the minimum value. Likewise, the stress versus martensite fraction curve for the highest value of phase transition rate is used if phase transition rate exceeds the maximum value.</p> <p>The values of SIG_ASS and SIG_ASF are overwritten if this option is used.</p>
LCID_SA	<p>Load curve ID or Table ID for reversed phase change (conversion of martensite into austenite). Load curve ID defining effective stress versus martensite fraction (ranging from 0 to 1). The table ID defines for each rate of the martensite fraction a load curve ID giving the stress versus martensite fraction for that phase transition rate. The stress versus martensite fraction curve for the lowest value of the phase transition rate is used if the phase transition rate falls below the minimum value. Likewise, the stress versus martensite fraction curve for the highest value of phase transition rate is used if phase transition rate exceeds the maximum value. The values of SIG_SAS and SIG_SAF are overwritten if this option is used.</p>

Remarks:

The material parameter alpha, α , measures the difference between material responses in tension and compression. In particular, it is possible to relate the parameter α to the initial stress value of the austenite into martensite conversion, indicated respectively as $\sigma_s^{AS,+}$ and $\sigma_s^{AS,-}$, according to the following expression:

$$\alpha = \frac{\sigma_s^{AS,-} - \sigma_s^{AS,+}}{\sigma_s^{AS,-} + \sigma_s^{AS,+}}$$

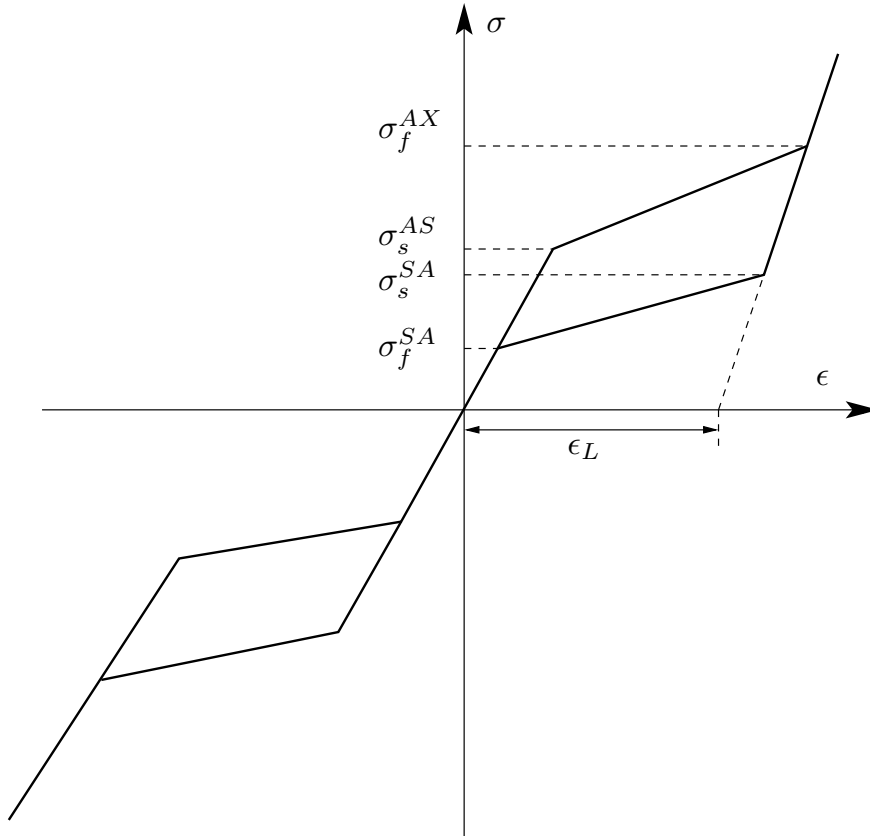

Figure 2-18. Superelastic Behavior for a Shape Memory Material

In the following, the results obtained from a simple test problem is reported. The material properties are set as:

E	60000 MPa
PR	0.3
SIG_ASS	520 MPa
SIG_ASF	600 MPa
SIG_SAS	300 MPa
SIG_SAF	200 MPa
EPSL	0.07
ALPHA	0.12
YMRT	50000 MPa

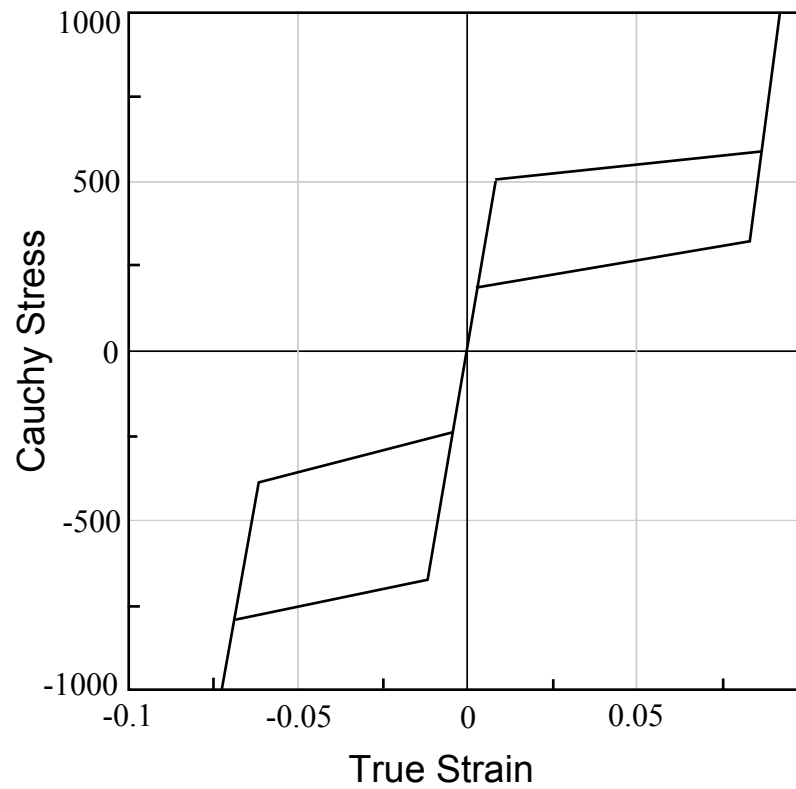

Figure 2-19. Complete loading-unloading test in tension and compression.

The investigated problem is the complete loading-unloading test in tension and compression. The uniaxial Cauchy stress versus the logarithmic strain is plotted in [Figure 2-19](#).

*MAT_FRAZER_NASH_RUBBER_MODEL

This is Material Type 31. This model defines rubber from uniaxial test data. It is a modified form of the hyperelastic constitutive law first described in Kenchington [1988]. See also the notes below.

Card 1	1	2	3	4	5	6	7	8
Variable	MID	RO	PR	C100	C200	C300	C400	
Type	A8	F	F	F	F	F	F	

Card 2	1	2	3	4	5	6	7	8
Variable	C110	C210	C010	C020	EXIT	EMAX	EMIN	REF
Type	F	F	F	F	F	F	F	F

Card 3	1	2	3	4	5	6	7	8
Variable	SGL	SW	ST	LCID				
Type	F	F	F	F				

VARIABLE	DESCRIPTION
MID	Material identification. A unique number or label not exceeding 8 characters must be specified.
RO	Mass density.
PR	Poisson's ratio. Values between .49 and .50 are suggested.
C100	C100 (EQ.1.0 if term is in the least squares fit.)
C200	C200 (EQ.1.0 if term is in the least squares fit.)
C300	C300 (EQ.1.0 if term is in the least squares fit.)

VARIABLE	DESCRIPTION
C400	C400 (EQ.1.0 if term is in the least squares fit.)
C110	C110 (EQ.1.0 if term is in the least squares fit.)
C210	C210 (EQ.1.0 if term is in the least squares fit.)
C010	C010 (EQ.1.0 if term is in the least squares fit.)
C020	C020 (EQ.1.0 if term is in the least squares fit.)
EXIT	Exit option: EQ.0.0: stop if strain limits are exceeded (recommended), NE.0.0: continue if strain limits are exceeded. The curve is then extrapolated.
EMAX	Maximum strain limit, (Green-St, Venant Strain).
EMIN	Minimum strain limit, (Green-St, Venant Strain).
REF	Use reference geometry to initialize the stress tensor. The reference geometry is defined by the keyword: *INITIAL_FOAM_REFERENCE_GEOMETRY (see there for more details). EQ.0.0: off, EQ.1.0: on.
SGL	Specimen gauge length, see Figure 2-15 .
SW	Specimen width, see Figure 2-15 .
ST	Specimen thickness, see Figure 2-15 .
LCID	Load curve ID, see DEFINE_CURVE, giving the force versus actual change in gauge length. See also Figure 2-16 for an alternative definition.

Remarks:

The constants can be defined directly or a least squares fit can be performed if the uniaxial data (SGL, SW, ST and LCID) is available. If a least squares fit is chosen, then the terms to be included in the energy functional are flagged by setting their corresponding coefficients

to unity. If all coefficients are zero the default is to use only the terms involving I_1 and I_2 . C_{100} defaults to unity if the least square fit is used.

The strain energy functional, U , is defined in terms of the input constants as:

$$U = C_{100}I_1 + C_{200}I_1^2 + C_{300}I_1^3 + C_{400}I_1^4 + C_{110}I_1I_2 + C_{210}I_1^2I_2 + C_{010}I_2 + C_{020}I_2^2 + f(J)$$

where the invariants can be expressed in terms of the deformation gradient matrix, F_{ij} , and the Green-St. Venant strain tensor, E_{ij} :

$$J = |F_{ij}|$$

$$I_1 = E_{ii}$$

$$I_2 = \frac{1}{2!} \delta_{pq}^{ij} E_{pi} E_{qj}$$

The derivative of U with respect to a component of strain gives the corresponding component of stress

$$S_{ij} = \frac{\partial U}{\partial E_{ij}}$$

here, S_{ij} , is the second Piola-Kirchhoff stress tensor.

The load curve definition that provides the uniaxial data should give the change in gauge length, ΔL , and the corresponding force. In compression both the force and the change in gauge length must be specified as negative values. In tension the force and change in gauge length should be input as positive values. The principal stretch ratio in the uniaxial direction, λ_1 , is then given by

$$\lambda = \frac{L_o + \Delta L}{L_o}$$

Alternatively, the stress versus strain curve can also be input by setting the gauge length, thickness, and width to unity and defining the engineering strain in place of the change in gauge length and the nominal (engineering) stress in place of the force, see [Figure 2-16](#) The least square fit to the experimental data is performed during the initialization phase and is a comparison between the fit and the actual input is provided in the printed file. It is a good idea to visually check the fit to make sure it is acceptable. The coefficients C_{100} - C_{020} are also printed in the output file.

***MAT_LAMINATED_GLASS**

This is Material Type 32. With this material model, a layered glass including polymeric layers can be modeled. Failure of the glass part is possible. See notes below.

Card 1	1	2	3	4	5	6	7	8
Variable	MID	RO	EG	PRG	SYG	ETG	EFG	EP
Type	A8	F	F	F	F	F	F	F

Card 2	1	2	3	4	5	6	7	8
Variable	PRP	SYP	ETP					
Type	F	F	F					

Integration Point Cards. Define 1-4 cards specifying up to 32 values. If less than 4 cards are input, reading is stopped by a "*" control card.

Card 3	1	2	3	4	5	6	7	8
Variable	F1	F2	F3	F4	F5	F6	F7	F8
Type	F	F	F	F	F	F	F	F

VARIABLE**DESCRIPTION**

MID	Material identification. A unique number or label not exceeding 8 characters must be specified.
RO	Mass density
EG	Young's modulus for glass
PRG	Poisson's ratio for glass
SYG	Yield stress for glass
ETG	Plastic hardening modulus for glass

VARIABLE	DESCRIPTION
EFG	Plastic strain at failure for glass
EP	Young's modulus for polymer
PRP	Poisson's ratio for polymer
SYP	Yield stress for polymer
ETP	Plastic hardening modulus for polymer
F1, ..., FN	Integration point material: $f_n = 0.0$: glass, $f_n = 1.0$: polymer. A user-defined integration rule must be specified, see *INTEGRATION_SHELL. See remarks below.

Remarks:

Isotropic hardening for both materials is assumed. The material to which the glass is bonded is assumed to stretch plastically without failure. A user defined integration rule specifies the thickness of the layers making up the glass. F_i defines whether the integration point is glass (0.0) or polymer (1.0). The material definition, F_i , has to be given for the same number of integration points (NIPTS) as specified in the rule. A maximum of 32 layers is allowed.

If the recommended user defined rule is not defined, the default integration rules are used. The location of the integration points in the default rules are defined in the *SECTION_SHELL keyword description.

***MAT_BARLAT_ANISOTROPIC_PLASTICITY**

This is Material Type 33. This model was developed by Barlat, Lege, and Brem [1991] for modeling anisotropic material behavior in forming processes. The finite element implementation of this model is described in detail by Chung and Shah [1992] and is used here. It is based on a six parameter model, which is ideally suited for 3D continuum problems, see notes below. For sheet forming problems, material 36 based on a 3-parameter model is recommended.

Card 1	1	2	3	4	5	6	7	8
Variable	MID	RO	E	PR	K	E0	N	M
Type	A8	F	F	F	F	F	F	F

Card 2	1	2	3	4	5	6	7	8
Variable	A	B	C	F	G	H	LCID	
Type	F	F	F	F	F	F	F	

Card 3	1	2	3	4	5	6	7	8
Variable	AOPT	OFFANG						
Type	F	F						

Card 4	1	2	3	4	5	6	7	8
Variable	XP	YP	ZP	A1	A2	A3		
Type	F	F	F	F	F	F		

Card 5	1	2	3	4	5	6	7	8
Variable	V1	V2	V3	D1	D2	D3		
Type	F	F	F	F	F	F		

VARIABLE**DESCRIPTION**

MID	Material identification. A unique number or label not exceeding 8 characters must be specified.
RO	Mass density.
E	Young's modulus, E.
PR	Poisson's ratio, ν .
K	k, strength coefficient, see notes below.
EO	ϵ_0 , strain corresponding to the initial yield, see notes below.
N	n, hardening exponent for yield strength.
M	m, flow potential exponent in Barlat's Model.
A	a, anisotropy coefficient in Barlat's Model.
B	b, anisotropy coefficient in Barlat's Model.
C	c anisotropy coefficient in Barlat's Model.
F	f, anisotropy coefficient in Barlat's Model.
G	g, anisotropy coefficient in Barlat's Model.
H	h, anisotropy coefficient in Barlat's Model.
LCID	Option load curve ID defining effective stress versus effective plastic strain. If nonzero, this curve will be used to define the yield stress. The load curve is implemented for solid elements only.

VARIABLE	DESCRIPTION
AOPT	<p>Material axes option:</p> <p>EQ.0.0: locally orthotropic with material axes determined by element nodes as shown in Figure 2-3. Nodes 1, 2, and 4 of an element are identical to the Nodes used for the definition of a coordinate system as by *DEFINE_COORDINATE_NODES.</p> <p>EQ.1.0: locally orthotropic with material axes determined by a point in space and the global location of the element center, this is the a-direction.</p> <p>EQ.2.0: globally orthotropic with material axes determined by vectors defined below, as with *DEFINE_COORDINATE_VECTOR.</p> <p>EQ.3.0: locally orthotropic material axes determined by offsetting the material axes by an angle, OFFANG, from a line determined by taking the cross product of the vector \mathbf{v} with the normal to the plane of the element.</p> <p>LT.0.0: the absolute value of AOPT is a coordinate system ID number (CID on *DEFINE_COORDINATE_NODES, *DEFINE_COORDINATE_SYSTEM or *DEFINE_COORDINATE_VECTOR). Available in R3 version of 971 and later.</p>
BETA	Offset angle for AOPT = 3.
MACF	<p>Material axes change flag for brick elements:</p> <p>EQ.1: No change, default,</p> <p>EQ.2: switch material axes a and b,</p> <p>EQ.3: switch material axes a and c,</p> <p>EQ.4: switch material axes b and c.</p>
XP YP ZP	Coordinates of point \mathbf{p} for AOPT = 1.
A1 A2 A3	Components of vector \mathbf{a} for AOPT = 2.
V1 V2 V3	Components of vector \mathbf{v} for AOPT = 3.
D1 D2 D3	Components of vector \mathbf{d} for AOPT = 2.

Remarks:

The yield function Φ is defined as:

$$\Phi = |S_1 - S_2|^m + |S_2 - S_3|^m + |S_3 - S_1|^m = 2\bar{\sigma}^m$$

where $\bar{\sigma}$ is the effective stress and $S_{i=1,2,3}$ are the principal values of the symmetric matrix $S_{\alpha\beta}$,

$$S_{xx} = [c(\sigma_{xx} - \sigma_{yy}) - b(\sigma_{zz} - \sigma_{xx})]/3$$

$$S_{yy} = [a(\sigma_{yy} - \sigma_{zz}) - c(\sigma_{xx} - \sigma_{yy})]/3$$

$$S_{zz} = [b(\sigma_{zz} - \sigma_{xx}) - a(\sigma_{yy} - \sigma_{zz})]/3$$

$$S_{yz} = f\sigma_{yz}$$

$$S_{zx} = g\sigma_{zx}$$

$$S_{xy} = h\sigma_{xy}$$

The material constants a, b, c, f, g and h represent anisotropic properties. When $a = b = c = f = g = h = 1$, the material is isotropic and the yield surface reduces to the Tresca yield surface for $m = 1$ and von Mises yield surface for $m = 2$ or 4.

For face centered cubic (FCC) materials $m = 8$ is recommended and for body centered cubic (BCC) materials $m = 6$ is used. The yield strength of the material is

$$\sigma_y = k(\varepsilon^p + \varepsilon_0)^n$$

where ε_0 is the strain corresponding to the initial yield stress and ε^p is the plastic strain.

***MAT_BARLAT_YLD96**

This is Material Type 33. This model was developed by Barlat, Maeda, Chung, Yanagawa, Brem, Hayashida, Lege, Matsui, Murtha, Hattori, Becker, and Makosey [1997] for modeling anisotropic material behavior in forming processes in particular for aluminum alloys. This model is available for shell elements only.

Card 1	1	2	3	4	5	6	7	8
Variable	MID	RO	E	PR	K			
Type	A8	F	F	F	F			

Card 2	1	2	3	4	5	6	7	8
Variable	E0	N	ESR0	M	HARD	A		
Type	F	F	F	F	F	F		

Card 3	1	2	3	4	5	6	7	8
Variable	C1	C2	C3	C4	AX	AY	AZ0	AZ1
Type	F	F	F	F	F	F	F	F

Card 4	1	2	3	4	5	6	7	8
Variable	AOPT	OFFANG						
Type	F	F						

Card 5	1	2	3	4	5	6	7	8
Variable				A1	A2	A3		
Type				F	F	F		

Card 6	1	2	3	4	5	6	7	8
Variable	V1	V2	V3	D1	D2	D3		
Type	F	F	F	F	F	F		

VARIABLE**DESCRIPTION**

MID	Material identification. A unique number or label not exceeding 8 characters must be specified.
RO	Mass density.
E	Young's modulus, E.
PR	Poisson's ratio, ν .
K	k , strength coefficient or a in Voce, see notes below.
EO	ϵ_0 , strain corresponding to the initial yield or b in Voce, see notes below.
N	n , hardening exponent for yield strength or c in Voce.
ESR0	ϵ_{SR0} , in powerlaw rate sensitivity.
M	m , exponent for strain rate effects
HARD	Hardening option: LT.0.0: absolute value defines the load curve ID. EQ.1.0: powerlaw EQ.2.0: Voce
A	Flow potential exponent.

VARIABLE	DESCRIPTION
C1	c1, see equations below.
C2	c2, see equations below.
C3	c3, see equations below.
C4	c4, see equations below.
AX	ax, see equations below.
AY	ay, see equations below.
AZ0	az0, see equations below.
AZ1	az1, see equations below.
AOPT	<p>Material axes option:</p> <p>EQ.0.0: locally orthotropic with material axes determined by element nodes as shown in Figure 2-3. Nodes 1, 2, and 4 of an element are identical to the Nodes used for the definition of a coordinate system as by *DEFINE_COORDINATE_NODES.</p> <p>EQ.2.0: globally orthotropic with material axes determined by vectors defined below, as with *DEFINE_COORDINATE_VECTOR.</p> <p>EQ.3.0: locally orthotropic material axes determined by offsetting the material axes by an angle, OFFANG, from a line determined by taking the cross product of the vector \mathbf{v} with the normal to the plane of the element.</p> <p>LT.0.0: the absolute value of AOPT is a coordinate system ID number (CID on *DEFINE_COORDINATE_NODES, *DEFINE_COORDINATE_SYSTEM or *DEFINE_COORDINATE_VECTOR). Available in R3 version of 971 and later.</p>
OFFANG	Offset angle for AOPT = 3.
A1 A2 A3	Components of vector \mathbf{a} for AOPT = 2.
V1 V2 V3	Components of vector \mathbf{v} for AOPT = 3.
D1 D2 D3	Components of vector \mathbf{d} for AOPT = 2.

Remarks:

The yield stress σ_y is defined three ways. The first, the Swift equation, is given in terms of the input constants as:

$$\sigma_y = k(\varepsilon_0 + \varepsilon^p)^n \left(\frac{\dot{\varepsilon}}{\varepsilon_{SR0}} \right)^m$$

The second, the Voce equation, is defined as:

$$\sigma_y = a - be^{-c\varepsilon^p}$$

and the third option is to give a load curve ID that defines the yield stress as a function of effective plastic strain. The yield function Φ is defined as:

$$\Phi = \alpha_1 |s_1 - s_2|^a + \alpha_2 |s_2 - s_3|^a + \alpha_3 |s_3 - s_1|^a = 2\sigma_y^a$$

where s_i is a principle component of the deviatoric stress tensor where in vector notation:

$$\underline{s} = \underline{L}\sigma$$

and \underline{L} is given as

$$L = \begin{bmatrix} \frac{c_2 + c_3}{3} & \frac{-c_3}{3} & \frac{-c_2}{3} & 0 \\ \frac{-c_3}{3} & \frac{c_3 + c_1}{3} & \frac{-c_1}{3} & 0 \\ \frac{-c_2}{3} & \frac{-c_1}{3} & \frac{c_1 + c_2}{3} & 0 \\ 0 & 0 & 0 & c_4 \end{bmatrix}$$

A coordinate transformation relates the material frame to the principle directions of \underline{s} is used to obtain the α_k coefficients consistent with the rotated principle axes:

$$\alpha_k = \alpha_x p_{1k}^2 + \alpha_y p_{2k}^2 + \alpha_z p_{3k}^2$$

$$\alpha_z = \alpha_{z0} \cos^2 2\beta + \alpha_{z1} \sin^2 2\beta$$

where p_{ij} are components of the transformation matrix. The angle β defines a measure of the rotation between the frame of the principal value of \underline{s} and the principal anisotropy axes.

***MAT_FABRIC**

This is Material Type 34. This material is especially developed for airbag materials. The fabric model is a variation on the layered orthotropic composite model of material 22 and is valid for 3 and 4 node membrane elements only. In addition to being a constitutive model, this model also invokes a special membrane element formulation which is more suited to the deformation experienced by fabrics under large deformation. For thin fabrics, buckling can result in an inability to support compressive stresses; thus a flag is included for this option. A linearly elastic liner is also included which can be used to reduce the tendency for these elements to be crushed when the no-compression option is invoked. In LS-DYNA versions after 931 the isotropic elastic option is available.

Card 1	1	2	3	4	5	6	7	8
Variable	MID	R0	EA	EB	EC	PRBA	PRCA	PRCB
Type	A8	F	F	F	F	F	F	F

Card 2	1	2	3	4	5	6	7	8
Variable	GAB	GBC	GCA	CSE	EL	PRL	LRATIO	DAMP
Type	F	F	F	F	F	F	F	F
Remarks				1	2	2	2	

Card 3	1	2	3	4	5	6	7	8
Variable	AOPT	FLC/X2	FAC/X3	ELA	LNRC	FORM	FVOPT	TSRFAC
Type	F	F	F	F	F	F	F	F
Remarks		3	3		4	0	0	10

Card 4	1	2	3	4	5	6	7	8
Variable				A1	A2	A3	X0	X1
Type				F	F	F	F	F

Card 5	1	2	3	4	5	6	7	8
Variable	V1	V2	V3	D1	D2	D3	BETA	ISREFG
Type	F	F	F	F	F	F	F	I

Additional card for FORM = 4, 14 or -14.

Card 6	1	2	3	4	5	6	7	8
Variable	LCA	LCB	LCAB	LCUA	LCUB	LCUAB	RL	
Type	I	I	I	I	I	I	F	

Additional card for FORM = -14.

Card 7	1	2	3	4	5	6	7	8
Variable	LCAA	LCBB	H	DT		ECOAT	SCOAT	TCOAT
Type	I	I	F	F		F	F	F

VARIABLE**DESCRIPTION**

MID	Material identification. A unique number or label not exceeding 8 characters must be specified.
RO	Mass density.

VARIABLE	DESCRIPTION
EA	Young's modulus - longitudinal direction. For an isotropic elastic fabric material only EA and PRBA are defined and are used as the isotropic Young's modulus and Poisson's ratio, respectively. The input for the fiber directions and liner should be input as zero for the isotropic elastic fabric
EB	Young's modulus - transverse direction, set to zero for isotropic elastic material.
(EC)	Young's modulus - normal direction, set to zero for isotropic elastic material. (Not used)
PRBA	ν_{ba} , Poisson's ratio ba direction.
(PRCA)	ν_{ca} , Poisson's ratio ca direction, set to zero for isotropic elastic material. (Not used)
(PRCB)	ν_{cb} , Poisson's ratio cb direction, set to zero for isotropic elastic material. (Not used)
GAB	G_{ab} , shear modulus ab direction, set to zero for isotropic elastic material.
(GBC)	G_{bc} , shear modulus bc direction, set to zero for isotropic elastic material. (Not used)
(GCA)	G_{ca} , shear modulus ca direction, set to zero for isotropic elastic material. (Not used)
CSE	Compressive stress elimination option (default 0.0): EQ.0.0: don't eliminate compressive stresses, EQ.1.0: eliminate compressive stresses (This option does not apply to the liner).
EL	Young's modulus for elastic liner (required if LRATIO > 0).
PRL	Poisson's ratio for elastic liner (required if LRATIO > 0).
LRATIO	A non-zero value activates the elastic liner and defines the ratio of liner thickness to total fabric thickness (optional).
DAMP	Rayleigh damping coefficient. A 0.05 coefficient is recommended corresponding to 5% of critical damping. Sometimes larger values are necessary.

VARIABLE	DESCRIPTION
AOPT	<p>Material axes option (see MAT_OPTIONTROPIC_ELASTIC for a more complete description):</p> <p>EQ.0.0: locally orthotropic with material axes determined by element nodes 1, 2, and 4, as with *DEFINE_COORDINATE_NODES, and then rotated about the element normal by an angle BETA.</p> <p>EQ.2.0: globally orthotropic with material axes determined by vectors defined below, as with *DEFINE_COORDINATE_VECTOR.</p> <p>EQ.3.0: locally orthotropic material axes determined by rotating the material axes about the element normal by an angle, BETA, from a line in the plane of the element defined by the cross product of the vector v with the element normal.</p> <p>LT.0.0: the absolute value of AOPT is a coordinate system ID number (CID on *DEFINE_COORDINATE_NODES, *DEFINE_COORDINATE_SYSTEM or *DEFINE_COORDINATE_VECTOR). Available in R3 version of 971 and later.</p>
FLC/X2	<p>If $X0 \neq 0$, $X0 \neq 1$: This is X2 coefficient of the porosity from the equation of Anagonye and Wang [1999]. Else, this is an optional constant, FLC, a fabric porous leakage flow coefficient.</p> <p>LT.0.0.AND.X0.EQ.0: FLC is the load curve ID of the curve defining FLC versus time.</p> <p>LT.0.0.AND.X0.EQ.1: FLC is the load curve ID defining FLC versus the stretching ratio defined as $r_s = A/A_0$. See notes below.</p>
FAC/X3	<p>If $X0 \neq 0$, $X0 \neq 1$: This is X3 coefficient of the porosity equation of Anagonye and Wang [1999]. Else, this is an optional constant, FAC, a fabric characteristic parameter.</p> <p><u>IF FVOPT < 7</u></p> <p>LT.0.AND.X0.EQ.0: FAC is the load curve ID of the curve defining FAC versus absolute pressure.</p> <p>LT.0.AND.X0.EQ.1: FAC is the load curve ID defining FAC versus the pressure ratio defined as $r_p = P_{air}/P_{bag}$. See remark 3 below.</p> <p><u>IF FVOPT ≥ 7</u></p>

VARIABLE	DESCRIPTION
	<p>LT.0.AND.X0.EQ.0: FAC defines leakage volume flux rate versus absolute pressure. The volume flux (per area) rate (per time) has the unit of $v\dot{o}l_{flux} \approx m^3/[m^2s] \approx m/s$, equivalent to relative porous gas speed.</p> <p>LT.0.AND.X0.EQ.1: FAC defines leakage volume flux rate versus the pressure ratio defined as $r_p = P_{air}/P_{bag}$. See remark 3 below.</p>
ELA	<p>Effective leakage area for blocked fabric, ELA.</p> <p>LT.0.0: ELA is the load curve ID of the curve defining ELA versus time. The default value of zero assumes that no leakage occurs. A value of .10 would assume that 10% of the blocked fabric is leaking gas.</p>
LNRC	<p>Flag to turn off compression in liner until the reference geometry is reached, i.e., the fabric element becomes tensile.</p> <p>EQ.0.0: off.</p> <p>EQ.1.0: on.</p>
FORM	<p>Flag to modify membrane formulation for fabric material:</p> <p>EQ.0.0: default: Least costly and very reliable.</p> <p>EQ.1.0: invariant local membrane coordinate system</p> <p>EQ.2.0: Green-Lagrange strain formulation</p> <p>EQ.3.0: large strain with nonorthogonal material angles. See Remark 5.</p> <p>EQ.4.0: large strain with nonorthogonal material angles and nonlinear stress strain behavior. Define optional load curve IDs on optional card.</p> <p>EQ.12.0: Updated form 2: See Remark 11.</p> <p>EQ.13.0: Updated form 3: See Remark 11.</p> <p>EQ.14.0: Updated form 4: See Remark 11.</p> <p>EQ.-14.0: Same as form 14, but invokes reading of card 7. See Remark 13.</p>
FVOPT	<p>Fabric venting option.</p> <p>EQ.1: Wang-Nefske formulas for venting through an orifice are</p>

VARIABLE	DESCRIPTION
	used. Blockage is not considered.
	EQ.2: Wang-Nefske formulas for venting through an orifice are used. Blockage of venting area due to contact is considered.
	EQ.3: Leakage formulas of Graefe, Krummheuer, and Siejak [1990] are used. Blockage is not considered.
	EQ.4: Leakage formulas of Graefe, Krummheuer, and Siejak [1990] are used. Blockage of venting area due to contact is considered.
	EQ.5: Leakage formulas based on flow through a porous media are used. Blockage is not considered.
	EQ.6: Leakage formulas based on flow through a porous media are used. Blockage of venting area due to contact is considered.
	EQ.7: Leakage is based on gas volume outflow versus pressure load curve [Lian, 2000]. Blockage is not considered. Absolute pressure is used in the porous-velocity-versus-pressure load curve, given as FAC in the *MAT_FABRIC card.
	EQ.8: Leakage is based on gas volume outflow versus pressure load curve [Lian 2000]. Blockage of venting or porous area due to contact is considered. Absolute pressure is used in the porous-velocity-versus-pressure load curve, given as FAC in the *MAT_FABRIC card.
TSRFAC	<p>Tensile stress cutoff reduction factor</p> <p>LT.0: TSRFAC is the curve ID of the curve defining TSRFAC versus time.'</p> <p>GT.0 and LT.1: TSRFAC applied from time 0.</p> <p>GE.1: TSRFAC is a curve ID for the new option.</p>
A1 A2 A3	Components of vector a for AOPT = 2.
X0,X1	Coefficients of Anagonye and Wang [1999] porosity equation for the leakage area: $A_{leak} = A_0(X_0 + X_1r_s + X_2r_p + X_3r_s r_p)$
V1 V2 V3	Components of vector v for AOPT = 3.
D1 D2 D3	Components of vector d for AOPT = 2.
BETA	Material angle in degrees for AOPT = 0 and 3, may be overridden on the element card, see *ELEMENT_SHELL_BETA.

VARIABLE	DESCRIPTION
ISREFG	Initial stress by reference geometry for FORM = 12 EQ.0.0: default. Not active. EQ.1.0: active
LCA	Load curve or table ID. Load curve ID defines the stress versus uniaxial strain along the a-axis fiber. Table ID defines for each strain rate a load curve representing stress versus uniaxial strain along the a-axis fiber. Available for FORM = 4, 14 and -14 only, table allowed only for form = -14. If zero, EA is used. For FORM = 14 and -14 this curve can be defined in both tension and compression, see remark 6 below.
LCB	Load curve or table ID. Load curve ID defines the stress versus uniaxial strain along the b-axis fiber. Table ID defines for each strain rate a load curve representing stress versus uniaxial strain along the b-axis fiber. Available for FORM = 4, 14 and -14 only, table allowed only for form = -14. If zero, EB is used. For FORM = 14 and -14 this curve can be defined in both tension and compression, see remark 6 below.
LCAB	Load curve ID for shear stress versus shear strain in the ab-plane; available for FORM = 4 or 14 only. If zero, GAB is used.
LCUA	Unload/reload curve ID for stress versus strain along the a-axis fiber; available for FORM = 4 or 14 only. If zero, LCA is used.
LCUB	Unload/reload curve ID for stress versus strain along the b-axis fiber; available for FORM = 4 or 14 only. If zero, LCB is used.
LCUAB	Unload/reload curve ID for shear stress versus shear strain in the ab-plane; available for FORM = 4 or 14 only. If zero, LCAB is used.
RL	Optional reloading parameter for FORM = 14. Values between 0.0 (reloading on unloading curve-default) and 1.0 (reloading on a minimum linear slope between unloading curve and loading curve) are possible.
LCAA	Load curve or table ID. Load curve ID defines the stress along the a-axis fiber versus biaxial strain. Table ID defines for each directional strain rate a load curve representing stress along the a-axis fiber versus biaxial strain. Available for FORM=-14 only, if zero, LCA is used.

VARIABLE	DESCRIPTION
LCBB	Load curve or table ID. Load curve ID defines the stress along the b-axis fiber versus biaxial strain. Table ID defines for each directional strain rate a load curve representing stress along the b-axis fiber versus biaxial strain. Available for FORM=-14 only, if zero, LCB is used.
H	Normalized hysteresis parameter between 0 and 1.
DT	Strain rate averaging option. EQ.0.0: Strain rate is evaluated using a running average. LT.0.0: Strain rate is evaluated using average of last 11 time steps. GT.0.0: Strain rate is averaged over the last DT time units.
ECOAT	Young's modulus of coat material, see remark 15.
SCOAT	Yield stress of coat material, see remark 15.
TCOAT	Thickness of coat material, may be positive or negative, see remark 15.

Remarks:

1. The no compression option allows the simulation of airbag inflation with far less elements than would be needed for the discretization of the wrinkles which would occur for the case when compressive stresses are not eliminated.
2. When using this material for the analysis of membranes as airbags it is well known from classical theory that only one layer has to be defined. The so-called elastic liner is often necessary to overcome numerical problems only when the compressive stress elimination option is active, CSE = 1.
3. The parameters FLC and FAC are optional for the Wang-Nefske and Hybrid inflation models. It is possible for the airbag to be constructed of multiple fabrics having different values for porosity and permeability. The leakage of gas through the fabric in an airbag then requires an accurate determination of the areas by part ID available for leakage. The leakage area may change over time due to stretching of the airbag fabric or blockage when the bag contacts the structure. LS-DYNA can check the interaction of the bag with the structure and split the areas into regions that are blocked and unblocked depending on whether the regions are in or not in contact, respectively. Typically, FLC and FAC must be determined experimentally and their variations in time or with pressure are optional to allow for maximum flexibility.

4. The elastic liner, if invoked, always acts in tension and compression, i.e., the compressive stress elimination option, CSE = 1, has no direct influence on the liner behavior. This can sometimes cause difficulties if the elements are very small in relationship to their actual size as defined by the reference geometry (See *AIRBAG_REFERENCE_GEOMETRY.). If the flag, LNRC, is set to 1.0 the elastic liner does not begin to act until the area of defined by the reference geometry is reached.
5. For FORM = 0, 1, and 2, the a-axis and b-axis fiber directions are assumed to be orthogonal and are completely defined by the material axes option, AOPT = 0, 2, or 3. For FORM = 3, 4, 13, or 14, the fiber directions are not assumed orthogonal and must be specified using the ICOMP = 1 option on *SECTION_SHELL. Offset angles should be input into the B1 and B2 fields used normally for integration points 1 and 2. The a-axis and b-axis directions will then be offset from the a-axis direction as determined by the material axis option, AOPT = 0, 2, or 3.
6. For FORM = 4 or 14 or -14, 2nd Piola-Kirchhoff stress vs. Green's strain curves may be defined for a-axis, b-axis, and shear stresses for loading and also for unloading and reloading. The shear loading curves should start at the origin and be defined for positive strains only. For FORM = 14 and -14, the uniaxial loading curves LCA and LCB may optionally be defined for negative values of strain, and negative values of strain should then correspond to negative values of stress, i.e., straightforward extending the curves into the compressive region. This is available in order to model the compressive stresses resulting from tight folding of airbags. The a-axis and b-axis stress follow the curves for the entire defined strain region and if compressive behavior is desired the user should preferably make sure the curve covers all strains of interest. For strains below the first point on the curve, the curve is extrapolated using the stiffness from the constant values, EA or EB. Shear stress/strain behavior is assumed symmetric. If a load curve is omitted, the stress is calculated from the appropriate constant modulus, EA, EB, or GAB.
7. When both loading and unloading curves are defined, the initial yield strain is assumed to be equal to the strain at the first point in the load curve with stress greater than zero. When strain exceeds the yield strain, the stress continues to follow the load curve and the yield strain is updated to the current strain. When unloading occurs, the unload/reload curve is shifted along the x-axis until it intersects the load curve at the current yield strain. If the curve shift is to the right, unloading and reloading will follow the shifted unload/reload curve. If the curve shift is zero or to the left, unloading and reloading will occur along the load curve. When using unloading curves, compressive stress elimination should be active to prevent the fibers from developing compressive stress during unloading when the strain remains tensile. If LCUA, LCUB, or LCUAB are input with negative values, then unloading is handled differently. Instead of shifting the unload curve along the x-axis, the curve is stretched in the x-direction such that the first point remains at (0,0) and the unload curve intersects with the load curve at the current yield point. This option guarantees the stress remains tensile while the strain is tensile so com-

pressive stress elimination is not necessary. To use this option the unload curve should have an initial slope less steep than the load curve, and should steepen such that it intersects the load curve at some positive strain value.

8. There are two ways that loading and unloading shear curves have been interpreted. Consider the shear stress as a function, f , of shear strain with a scale factors c_1 for the strain and c_2 for the stress.

$$\sigma_{ab} = c_2 f(c_1 \varepsilon_{ab})$$

The table below shows the scale factor values for versions and fabric forms.

Fabric form	4		14 and -14	
	c_1	c_2	c_1	c_2
ls971 R5.1.0 and earlier	2	1	2	1
ls971 R6.0.0 and later	2	1	1	2

When switching fabric forms or versions, the curve scale factors SFA and SFO on *DEFINE_CURVE can be used to offset this behavior.

9. The FVOPT flag allows an airbag fabric venting equation to be assigned to an material. The anticipated use for this option is to allow a vent to be defined using FVOPT = 1 or 2 for one material and fabric leakage to be defined for using FVOPT = 3, 4, 5, or 6 for other materials. In order to use FVOPT, a venting option must first be defined for the airbag using the OPT parameter on *AIRBAG_WANG_NEFSKE or *AIRBAG_HYBRID. If OPT = 0, then FVOPT is ignored. If OPT is defined and FVOPT is omitted, then FVOPT is set equal to OPT.
10. The TSRFAC factor is used to assure that airbags that have a reference geometry will open to the correct geometry. Airbags that use a reference geometry might have an initial geometry that results in initial strains. To prevent such strains from prematurely opening an airbag, these strains are eliminated by default. A side effect of this behavior is that airbags that use a reference geometry and that are initially stretched will never achieve the correct shape. The TSRFAC factor is used to restore the tensile strains over time such that the correct geometry is achieved. It is recommended that a load curve be used to define TSRFAC as function of time. Initially the load curve ordinate value should be 0.0 which will allow the bag to remain unstressed. At a time when the bag is partially open, the value of TSRFAC should ramp up to a small number of about 0.0001. Each cycle, the stored initial strains are scaled by (1.0-TSRFAC) such that they reduce to a very small number. A new option is invoked by setting TSRFAC ≥ 1 in which case TSRFAC is a curve ID. The curve should ramp from 0.0 to 1.0. When the curve ordinate value is 0.0, the stored initial strain is subtracted from the total strain. For values between 0.0 and 1.0, a fraction of the stored initial strain is subtracted from the total strain

where the fraction is 1.0-TSRFAC. When the curve value reaches or exceeds 1.0, the total strain is used. This option gives the user better control of the rate of restoring the strains as it is independent of the solution time step.

11. Material forms 12, 13, and 14 are updated versions of forms 2, 3, and 4, respectively. These new forms are intended to be less susceptible to timestep collapse and also guarantee zero stress in the initial geometry when a reference geometry is used. The behavior should otherwise be similar with one exception. The LNRC flag eliminates not only initial compressive strain but total initial strain. Therefore, the TSRFAC option is recommended (see Remark 9) when forms 12, 13, and 14 are used with a reference geometry and LNRC = 1.
12. An option to calculate the initial stress by using a reference geometry is available for material FORM 12 only.
13. If tables are used the strain rate measure is the Green-Lagrange strain rate of the Green-Lagrange strain in the direction of interest. To suppress noise the strain rate is averaged according to the value of DT. If $DT > 0$, it is recommended to use a large enough value to suppress the noise but small enough to not lose important frequency content. This option seems to be the most robust averaging choice.
14. The hysteresis parameter H defines the fraction of dissipated energy during a load cycle in terms of the maximum possible dissipated energy. Referring to the [Figure 2-20](#),

$$H \approx \frac{A_1}{A_1 + A_2}$$

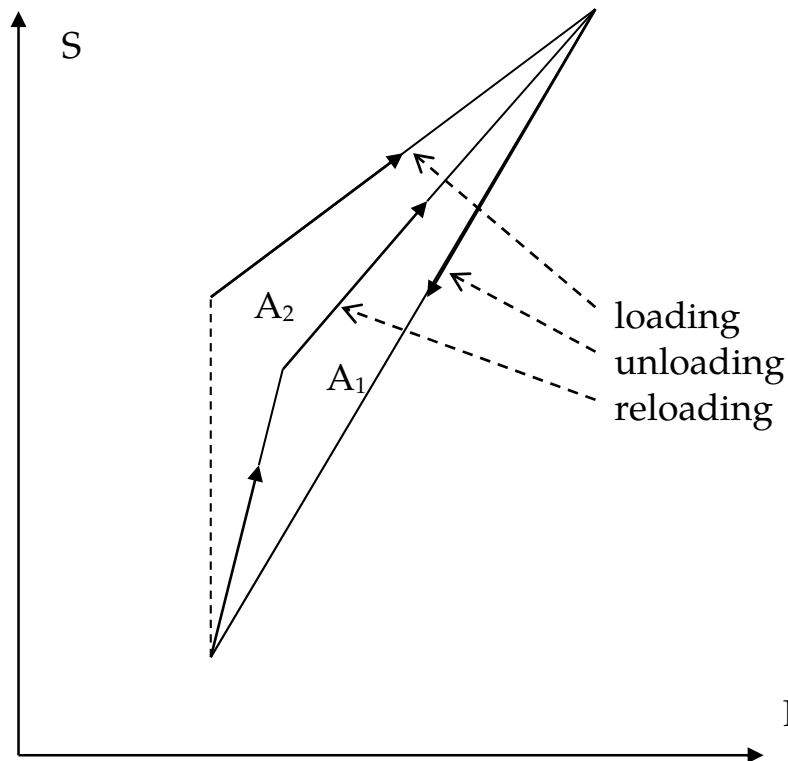

Figure 2-20.

- 15. It is possible to model coating of the fabric using a sheet of elastic-ideal plastic material where the Young's modulus, yield stress and thickness is specified for the coat material. This will add rotational resistance to the fabric for a more realistic behavior of coated fabrics. To read in these three parameters you need to put FORM = -14 which reads the extra line including the last three parameters ECOAT, SCOAT and TCOAT, corresponding to the three coat material properties mentioned above. The thickness applies to both sides of the fabric. The coat material for a certain fabric element deforms in accordance to the deformation of this and all elements connected to this element, which is how the rotations are "captured". Note that coating also adds to the membrane stiffness unless TCOAT is set to a negative number for which the membrane contribution from the coating is suppressed and the thickness of the coating is interpreted as the absolute value of TCOAT. For this feature to work, the fabric parts must not have T-intersections and the normals of connected fabric elements must point in the same direction. A penalty in speed is incurred with this option.

***MAT_PLASTIC_GREEN-NAGHDI_RATE**

This is Material Type 35. This model is available only for brick elements and is similar to model 3, but uses the Green-Naghdi Rate formulation rather than the Jaumann rate for the stress update. For some cases this might be helpful. This model also has a strain rate dependency following the Cowper-Symonds model.

Card 1	1	2	3	4	5	6	7	8
Variable	MID	RO	E	PR				
Type	A8	F	F	F				

Card 2	1	2	3	4	5	6	7	8
Variable	SIGY	ETAN	SRC	SRP	BETA			
Type	F	F	F	F	F			

VARIABLE**DESCRIPTION**

MID	Material identification. A unique number or label not exceeding 8 characters must be specified.
RO	Density
E	Young's modulus
PR	Poisson's ratio
SIGY	Yield stress
ETAN	Plastic hardening modulus
SRC	Strain rate parameter, C
SRP	Strain rate parameter, P
BETA	Hardening parameter, $0 < \beta' < 1$

***MAT_3-PARAMETER_BARLAT_{OPTION}**

This is Material Type 36. This model was developed by Barlat and Lian [1989] for modeling sheets with anisotropic materials under plane stress conditions. This material allows the use of the Lankford parameters for the definition of the anisotropy. This particular development is due to Barlat and Lian [1989]. A version of this material model which has a flow limit diagram failure option is *MAT_FLD_3-PARAMETER_BARLAT.

Available options include:

<BLANK>

NLP

The option **NLP** allows for prediction of sheet metal failure using the Formability Index (F.I.), which accounts for the non-linear strain path effect (see remarks below). The variable NLP in card #3 needs to be defined when using the option.

Card 1	1	2	3	4	5	6	7	8
Variable	MID	R0	E	PR	HR	P1	P2	ITER
Type	A8	F	F	F	F	F	F	F

Card 2	1	2	3	4	5	6	7	8
Variable	M	R00/AB	R45/CB	R90/HB	LCID	E0	SPI	P3
Type	F	F	F	F	I	F	F	F

Define the following card if and only if $M < 0$

Card opt.	1	2	3	4	5	6	7	8
Variable	CRC1	CRA1	CRC2	CRA2	CRC3	CRA3	CRC4	CRA4
Type	F	F	F	F	F	F	F	F

Card 3	1	2	3	4	5	6	7	8
Variable	AOPT	C	P	VLCID		PB	NLP/HTA	HTB
Type	F	F	F	I		F	I/F	F

Card 4	1	2	3	4	5	6	7	8
Variable				A1	A2	A3	HTC	HTD
Type				F	F	F	F	F

Card 5	1	2	3	4	5	6	7	8
Variable	V1	V2	V3	D1	D2	D3	BETA	HTFLAG
Type	F	F	F	F	F	F	F	F

Optional card.

Card 6	1	2	3	4	5	6	7	8
Variable	USRFail							
Type	F							

VARIABLE

DESCRIPTION

- MID Material identification. A unique number or label not exceeding 8 characters must be specified.
- RO Mass density.
- E Young's modulus, E
 GT.0.0: Constant value,
 LT.0.0: Load curve ID = (-E) which defines Young's Modulus as a function of plastic strain. See Remark 1.

VARIABLE	DESCRIPTION
PR	Poisson's ratio, ν
HR	Hardening rule: EQ.1.0: linear (default), EQ.2.0: exponential (Swift) EQ.3.0: load curve or table with strain rate effects EQ.4.0: exponential (Voce) EQ.5.0: exponential (Gosh) EQ.6.0: exponential (Hockett-Sherby) EQ.7.0: load curves in three directions EQ.8.0: table with temperature dependence EQ.9.0: 3d table with temperature and strain rate dependence
P1	Material parameter: HR.EQ.1.0: Tangent modulus, HR.EQ.2.0: k, strength coefficient for Swift exponential hardening HR.EQ.4.0: a, coefficient for Voce exponential hardening HR.EQ.5.0: k, strength coefficient for Gosh exponential hardening HR.EQ.6.0: a, coefficient for Hockett-Sherby exponential hardening HR.EQ.7.0: load curve ID for hardening in 45 degree direction. See Remark 2.
P2	Material parameter: HR.EQ.1.0: Yield stress HR.EQ.2.0: n, exponent for Swift exponential hardening HR.EQ.4.0: c, coefficient for Voce exponential hardening HR.EQ.5.0: n, exponent for Gosh exponential hardening HR.EQ.6.0: c, coefficient for Hockett-Sherby exponential hardening HR.EQ.7.0: load curve ID for hardening in 90 degree direction. See Remark 2.

VARIABLE	DESCRIPTION
ITER	Iteration flag for speed: ITER.EQ.0.0: fully iterative ITER.EQ.1.0: fixed at three iterations Generally, ITER = 0 is recommended. However, ITER = 1 is somewhat faster and may give acceptable results in most problems.
M	m, exponent in Barlat's yield surface, absolute value is used if negative.
CRCN	Chaboche-Roussiler hardening parameter, see remarks.
CRCA	Chaboche-Roussiler hardening parameter, see remarks.
R00	R ₀₀ , Lankford parameter in 0 degree direction GT.0.0: Constant value, LT.0.0: Load curve or Table ID = (-R00) which defines R value as a function of plastic strain (Curve) or as a function of temperature and plastic strain (Table). See Remark 3.
R45	R ₄₅ , Lankford parameter in 45 degree direction GT.0.0: Constant value, LT.0.0: Load curve or Table ID = (-R45) which defines R value as a function of plastic strain (Curve) or as a function of temperature and plastic strain (Table). See Remarks 2 and 3.
R90	R ₉₀ , Lankford parameter in 90 degree direction GT.0.0: Constant value, LT.0.0: Load curve or Table ID = (-R90) which defines R value as a function of plastic strain (Curve) or as a function of temperature and plastic strain (Table). See Remarks 2 and 3.
AB	a, Barlat89 parameter, which is read instead of R00 if PB > 0.
CB	c, Barlat89 parameter, which is read instead of R45 if PB > 0.
HB	h, Barlat89 parameter, which is read instead of R90 if PB > 0.

VARIABLE	DESCRIPTION
LCID	Load curve/table ID for hardening in the 0 degree direction. See Remark 1.
E0	Material parameter HR.EQ.2.0: ϵ_0 for determining initial yield stress for Swift exponential hardening. (Default = 0.0) HR.EQ.4.0: b , coefficient for Voce exponential hardening HR.EQ.5.0: ϵ_0 for determining initial yield stress for Gosh exponential hardening. (Default = 0.0) HR.EQ.6.0: b , coefficient for Hocket-Sherby exponential hardening
SPI	<u>Case I: if ϵ_0 is zero above and HR.EQ.2.0. (Default = 0.0)</u> EQ.0.0: $\epsilon_0 = (E/k) ** [1/(n - 1)]$ LE.0.02: $\epsilon_0 = spi$ GT.0.02: $\epsilon_0 = (spi/k) ** [1/n]$ Case II: If HR.EQ.5.0 The strain at plastic yield is determined by an iterative procedure based on the same principles as for HR.EQ.2.0.
P3	Material parameter: HR.EQ.5.0: p , parameter for Gosh exponential hardening HR.EQ.6.0: n , exponent for Hocket-Sherby exponential hardening
AOPT	Material axes option (see MAT_OPTION TROPIC_ELASTIC for a more complete description): EQ.0.0: locally orthotropic with material axes determined by element nodes 1, 2, and 4, as with *DEFINE_COORDINATE_NODES, and then rotated about the shell element normal by an angle BETA. EQ.2.0: globally orthotropic with material axes determined by vectors defined below, as with *DEFINE_COORDINATE_VECTOR. EQ.3.0: locally orthotropic material axes determined by rotating the material axes about the element normal by an angle, BETA, from a line in the plane of the element defined by the cross product of the vector v with the element nor-

VARIABLE	DESCRIPTION
	mal.
	LT.0.0: the absolute value of AOPT is a coordinate system ID number (CID on *DEFINE_COORDINATE_NODES, *DEFINE_COORDINATE_SYSTEM or *DEFINE_COORDINATE_VECTOR). Available with the R3 release of Version 971 and later.
C	C in Cowper-Symonds strain rate model
P	p in Cowper-Symonds strain rate model, p = 0.0 for no strain rate effects
VLCID	Volume correction curve ID defining the relative volume change (change in volume relative to the initial volume) as a function of the effective plastic strain. This is only used when nonzero. See Remark 1.
PB	Barlat89 parameter, p. If PB > 0, parameters AB, CB, and HB are read instead of R00, R45, and R90. See remarks below.
NLP	Load curve ID of the Forming Limit Diagram (FLD) under linear strain paths (see remarks below). Define when option NLP is used.
HTA	Load curve/Table ID for postforming parameter A in heat treatment
HTB	Load curve/Table ID for postforming parameter B in heat treatment
XP YP ZP	Coordinates of point p for AOPT = 1.
A1 A2 A3	Components of vector a for AOPT = 2.
HTC	Load curve/Table ID for postforming parameter C in heat treatment
HTD	Load curve/Table ID for postforming parameter D in heat treatment
V1 V2 V3	Components of vector v for AOPT = 3.
D1 D2 D3	Components of vector d for AOPT = 2.
BETA	Material angle in degrees for AOPT = 0 and 3, may be overridden on the element card, see *ELEMENT_SHELL_BETA.

VARIABLE	DESCRIPTION
HTFLAG	Heat treatment flag (see remarks): HTFLAG.EQ.0: Preforming stage HTFLAG.EQ.1: Heat treatment stage HTFLAG.EQ.2: Postforming stage
USRFAIL	User defined failure flag USRFAIL.EQ.0: no user subroutine is called USRFAIL.EQ.1: user subroutine matusr_24 in dyn21.f is called

Formulation:

The effective plastic strain used in this model is defined to be plastic work equivalent. A consequence of this is that for parameters defined as functions of effective plastic strain, the rolling (00) direction should be used as reference direction. For instance, the hardening curve for HR = 3 is the stress as function of strain for uniaxial tension in the rolling direction, VLCID curve should give the relative volume change as function of strain for uniaxial tension in the rolling direction and load curve given by -E should give the Young's modulus as function of strain for uniaxial tension in the rolling direction. Optionally the curve can be substituted for a table defining hardening as function of plastic strain rate (HR = 3) or temperature (HR = 8).

Exceptions from the rule above are curves defined as functions of plastic strain in the 45 and 90 directions, i.e., P1 and P2 for HR = 7 and negative R45 or R90. The hardening curves are here defined as measured stress as function of measured plastic strain for uniaxial tension in the direction of interest, i.e., as determined from experimental testing using a standard procedure. Moreover, the curves defining the R values are as function of the measured plastic strain for uniaxial tension in the direction of interest. These curves are transformed internally to be used with the effective stress and strain properties in the actual model. The effective plastic strain does not coincide with the plastic strain components in other directions than the rolling direction and may be somewhat confusing to the user. Therefore the von Mises work equivalent plastic strain is output as history variable #2 if HR = 7 or if any of the R-values is defined as function of the plastic strain.

The R-values in curves are defined as the ratio of instantaneous width change to instantaneous thickness change. That is, assume that the width W and thickness T are measured as function of strain. Then the corresponding R-value is given by:

$$R = \frac{\frac{dW}{d\varepsilon} / W}{\frac{dT}{d\varepsilon} / T}$$

The anisotropic yield criterion Φ for plane stress is defined as:

$$\Phi = a|K_1 + K_2|^m + a|K_1 - K_2|^m + c|2K_2|^m = 2\sigma_Y^m$$

where σ_Y is the yield stress and $K_i = 1,2$ are given by:

$$K_1 = \frac{\sigma_x + h\sigma_y}{2}$$

$$K_2 = \sqrt{\left(\frac{\sigma_x - h\sigma_y}{2}\right)^2 + p^2\tau_{xy}^2}$$

If $PB = 0$, the anisotropic material constants a , c , h , and p are obtained through R_{00} , R_{45} , and R_{90} :

$$a = 2 - 2\sqrt{\frac{R_{00}}{1 + R_{00}} \frac{R_{90}}{1 + R_{90}}} c = 2 - a$$

$$h = \sqrt{\frac{R_{00}}{1 + R_{00}} \frac{1 + R_{90}}{R_{90}}}$$

The anisotropy parameter p is calculated implicitly. According to Barlat and Lian the R value, width to thickness strain ratio, for any angle ϕ can be calculated from:

$$R_\phi = \frac{2m\sigma_Y^m}{\left(\frac{\partial\Phi}{\partial\sigma_x} + \frac{\partial\Phi}{\partial\sigma_y}\right)\sigma_\phi} - 1$$

where σ_ϕ is the uniaxial tension in the ϕ direction. This expression can be used to iteratively calculate the value of p . Let $\phi = 45$ and define a function g as:

$$g(p) = \frac{2m\sigma_Y^m}{\left(\frac{\partial\Phi}{\partial\sigma_x} + \frac{\partial\Phi}{\partial\sigma_y}\right)\sigma_\phi} - 1 - R_{45}$$

An iterative search is used to find the value of p . If $PB > 0$, material parameters a (AB), c (CB), h (HB), and p (PB) are used directly.

For face centered cubic (FCC) materials $m = 8$ is recommended and for body centered cubic (BCC) materials $m = 6$ may be used. The yield strength of the material can be expressed in terms of k and n :

$$\sigma_y = k\varepsilon^n = k(\varepsilon_{yp} + \bar{\varepsilon}^p)^n$$

where ε_{yp} is the elastic strain to yield and $\bar{\varepsilon}^p$ is the effective plastic strain (logarithmic). If SIGY is set to zero, the strain to yield is found by solving for the intersection of the linearly elastic loading equation with the strain hardening equation:

$$\sigma = E\varepsilon$$

$$\sigma = k\varepsilon^n$$

which gives the elastic strain at yield as:

$$\varepsilon_{yp} = \left(\frac{E}{k}\right)^{\frac{1}{n-1}}$$

If SIGY yield is nonzero and greater than 0.02 then:

$$\varepsilon_{yp} = \left(\frac{\sigma_y}{k}\right)^{\frac{1}{n}}$$

The other available hardening models include the Voce equation given by:

$$\sigma_Y(\varepsilon_p) = a - be^{-c\varepsilon_p},$$

the Gosh equation given by:

$$\sigma_Y(\varepsilon_p) = k(\varepsilon_0 + \varepsilon_p)^n - p,$$

and finally the Hockett-Sherby equation given by:

$$\sigma_Y(\varepsilon_p) = a - be^{-c\varepsilon_p^n}.$$

For the Gosh hardening law, the interpretation of the variable SPI is the same, i.e., if set to zero the strain at yield is determined implicitly from the intersection of the strain hardening equation with the linear elastic equation.

To include strain rate effects in the model we multiply the yield stress by a factor depending on the effective plastic strain rate. We use the Cowper-Symonds' model, hence the yield stress can be written as:

$$\sigma_Y(\varepsilon_p, \dot{\varepsilon}_p) = \sigma_Y^s(\varepsilon_p) \left\{ 1 + \left(\frac{\dot{\varepsilon}_p}{C}\right)^{1/p} \right\}$$

where σ_Y^s denotes the static yield stress, C and p are material parameters, $\dot{\varepsilon}_p$ is the effective plastic strain rate.

A kinematic hardening model is implemented following the works of Chaboche and Rous-silier. A back stress α is introduced such that the effective stress is computed as:

$$\sigma_{\text{eff}} = \sigma_{\text{eff}}(\sigma_{11} - 2\alpha_{11} - \alpha_{22}, \sigma_{22} - 2\alpha_{22} - \alpha_{11}, \sigma_{12} - \alpha_{12})$$

The back stress is the sum of up to four terms according to:

$$\alpha_{ij} = \sum_{k=1}^4 \alpha_{ij}^k$$

and the evolution of each back stress component is as follows:

$$\delta\alpha_{ij}^k = C_k \left(a_k \frac{s_{ij}}{\sigma_{\text{eff}}} - \alpha_{ij}^k \right) \delta\varepsilon_p$$

where C_k and a_k are material parameters, s_{ij} is the deviatoric stress tensor, σ_{eff} is the effective stress and ε_p is the effective plastic strain. The yield condition is for this case modified according to

$$f(\boldsymbol{\sigma}, \boldsymbol{\alpha}, \varepsilon_p) = \sigma_{\text{eff}}(\sigma_{11} - 2\alpha_{11} - \alpha_{22}, \sigma_{22} - 2\alpha_{22} - \alpha_{11}, \sigma_{12} - \alpha_{12}) - \left\{ \sigma_Y^t(\varepsilon_p, \dot{\varepsilon}_p, 0) - \sum_{k=1}^4 a_k [1 - \exp(-C_k \varepsilon_p)] \right\} \leq 0$$

in order to get the expected stress strain response for uniaxial stress.

A failure criterion for nonlinear strain paths in sheet metal forming:

When the option **NLP** is used, a necking failure criterion is activated to account for the nonlinear strain path effect in sheet metal forming. Based on the traditional Forming Limit Diagram (FLD) for the linear strain path, the Formability Index (F.I.) is calculated for every element in the model throughout the simulation duration and the entire history is stored in history variable #9 in D3PLOT files, accessible from *Post/History* menu in LS-PrePost v4.0. The time history of the index can be plotted for each element under the menu. It is therefore necessary to set NEIPS to 10, in the second field of card 1 in keyword *DATABASE_EXTENT_BINARY, to output the history variable to the D3PLOT files. The index can also be plotted as a color contour map on the formed sheet blank, accessible from *Post/FriComp/Misc* menu. The index has a value ranging from 0.0 to 1.2, with the onset of necking failure at 1.0. The F.I. is calculated based on critical effect strain method, as illustrated in [figure 2-24](#) in remarks section in *MAT_037. The theoretical background can be found in two papers also referenced in remarks section in *MAT_037.

D3PLOT files can be used to plot the history variable #9 (the F.I.) in color contour. The value in the “Max” pull-down menu in *Post/FriComp* needs to be set to “Min”, meaning that the necking failure occurs only when all integration points through the thickness have reached the critical value of 1.0. It is suggested to set the variable ‘MAXINT’ in *DATABASE_EXTENT_BINARY to the same value as the variable ‘NIP’ in *SECTION_SHELL. In addition, the value in the “Avg” pull-down menu in *Post/FriRang* needs to be set to “None”. The strain path history (major vs. minor strain) of each element can be plotted with radial dial button *Strain Path* in *Post/FLD*.

An example of a partial input for the material is provided below, where the FLD for the linear strain path is defined by the variable NLP with load curve ID 211, where abscissa values represent minor strains and ordinate values represent major strains.

```
*MAT_3-PARAMETER_BARLAT_NLP
$-----1-----2-----3-----4-----5-----6-----7-----8
$      MID      RO      E      PR      HR      P1      P2      ITER
$      1 2.890E-09 6.900E04 0.330 3.000
$      M      R00      R45      R90      LCID      E0      SPI      P3
$      8.000      0.800      0.600      0.550      99
$      AOPT      C      P      VLCID      NLP
```

```

      2.000
$
      A1      A2      A3      211
$      V1      V2      V3      0.000      1.000      0.000
      D1      D2      D3      BETA
$-----1-----2-----3-----4-----5-----6-----7-----8
$ Hardening Curve
*DEFINE_CURVE
  99
      0.000      130.000
      0.002      134.400
      0.006      143.000
      0.010      151.300
      0.014      159.300
      :
      0.900      365.000
      1.000      365.000
$ FLD Definition
*DEFINE_CURVE
211
      -0.2      0.325
      -0.1054      0.2955
      -0.0513      0.2585
      0.0000      0.2054
      0.0488      0.2240
      0.0953      0.2396
      0.1398      0.2523
      0.1823      0.2622
      :

```

Shown in Figures [2-21](#), [2-22](#) and [2-23](#), predictions and validations of forming limit curves (FLC) of various nonlinear strain paths on a single shell element was done using this new option, for an Aluminum alloy with $r_{00} = 0.8$, $r_{45} = 0.6$, $r_{90} = 0.55$, and yield at 130.0 MPa. In each case, the element is further strained in three different paths (uniaxial stress – U.A., plane strain – P.S., and equi-biaxial strain – E.B.) separately, following a pre-straining in uniaxial, plane strain and equi-biaxial strain state, respectively. The forming limits are determined at the end of the secondary straining for each path, when the F.I. has reached the value of 1.0. It is seen that the FLCs (dashed curves) in case of the nonlinear strain paths are totally different from the FLCs under the linear strain paths. It is noted that the current predicted FLCs under nonlinear strain path are obtained by connecting the ends of the three distinctive strain paths. More detailed FLCs can be obtained by straining the elements in more paths between U.A. and P.S. and between P.S. and E.B.

Typically, to assess sheet formability, F.I. contour of the entire part should be plotted. Based on the contour plot, non-linear strain path and the F.I. time history of a few elements in the area of concern can be plotted for further study. These plots are similar to those shown in manual pages of *MAT_037.

It is noted that the option **NLP** is implemented for Explicit Dynamic analysis and is available pending a release soon.

Heat treatment with variable HTFLAG:

Heat treatment for increasing the formability of prestrained aluminum sheets can be simulated through the use of HTFLAG, where the intention is to run a forming simulation in steps involving preforming, springback, heat treatment and postforming. In each step the history is transferred to the next via the use of dynain (see *INTERFACE_SPRINGBACK). The first two steps are performed with HTFLAG = 0 according to standard procedures, resulting in a plastic strain field ε_p^0 corresponding to the prestrain. The heat treatment step is performed using HTFLAG = 1 in a coupled thermomechanical simulation, where the blank is heated. The coupling between thermal and mechanical is only that the maximum temperature T^0 is stored as a history variable in the material model, this corresponding to the heat treatment temperature. Here it is important to export all history variables to the dynein file for the postforming step. In the final postforming step, HTFLAG = 2, the yield stress is then augmented by the Hockett-Sherby like term:

$$\Delta\sigma = b - (b - a)\exp\left[-c(\varepsilon_p - \varepsilon_p^0)^d\right]$$

where a , b , c and d are given as tables as functions of the heat treatment temperature T^0 and prestrain ε_p^0 . That is, in the table definitions each load curve corresponds to a given prestrain and the load curve value is with respect to the heat treatment temperature,

$$a = a(T^0, \varepsilon_p^0) \quad b = b(T^0, \varepsilon_p^0) \quad c = c(T^0, \varepsilon_p^0) \quad d = d(T^0, \varepsilon_p^0)$$

The effect of heat treatment is that the material strength decreases but hardening increases, thus typically:

$$a \leq 0 \quad b \geq a \quad c > 0 \quad d > 0$$

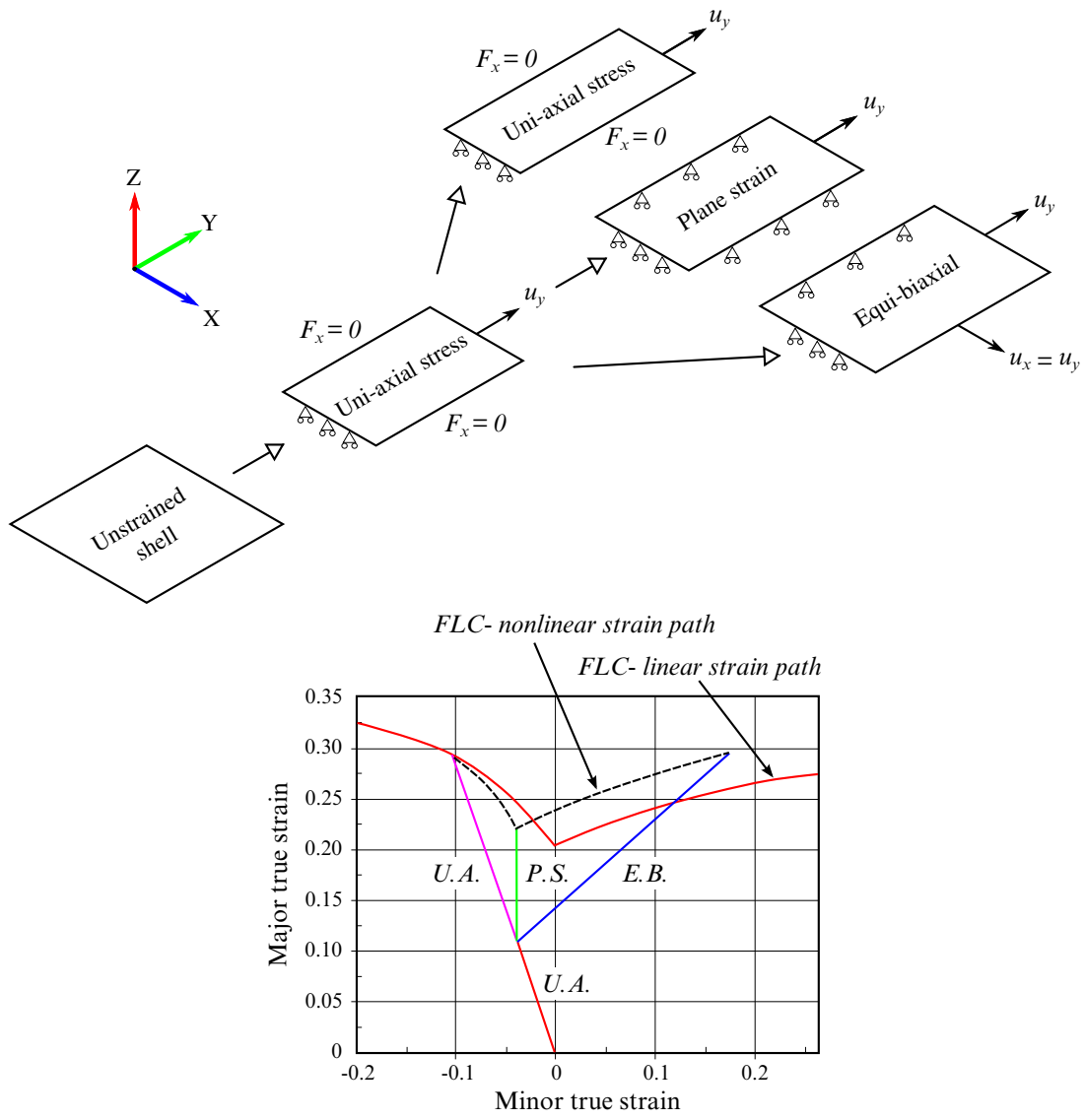

Figure 2-21. Nonlinear FLD prediction with uniaxial pre-straining.

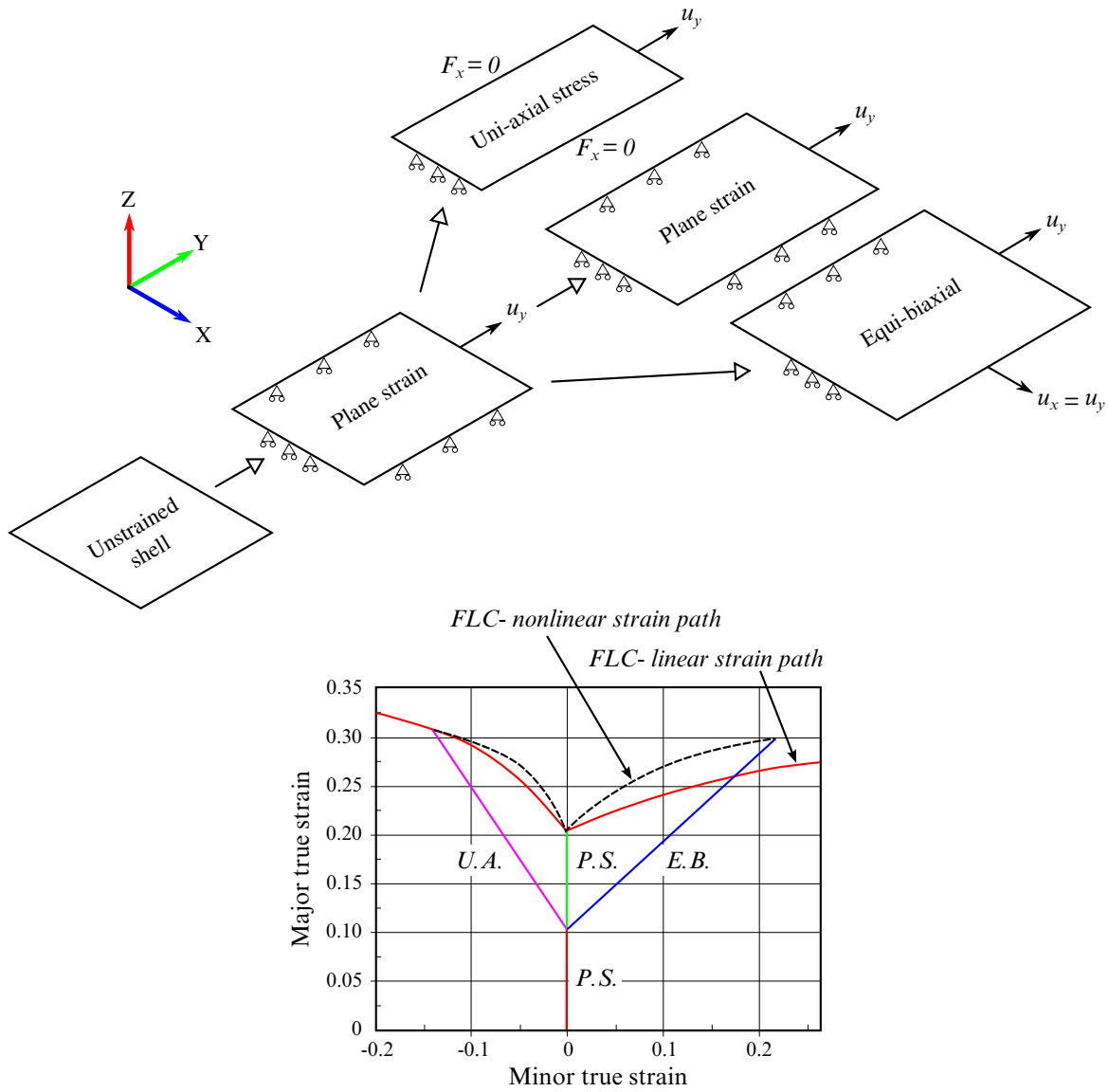

Figure 2-22. Nonlinear FLD prediction with plane strain pre-straining.

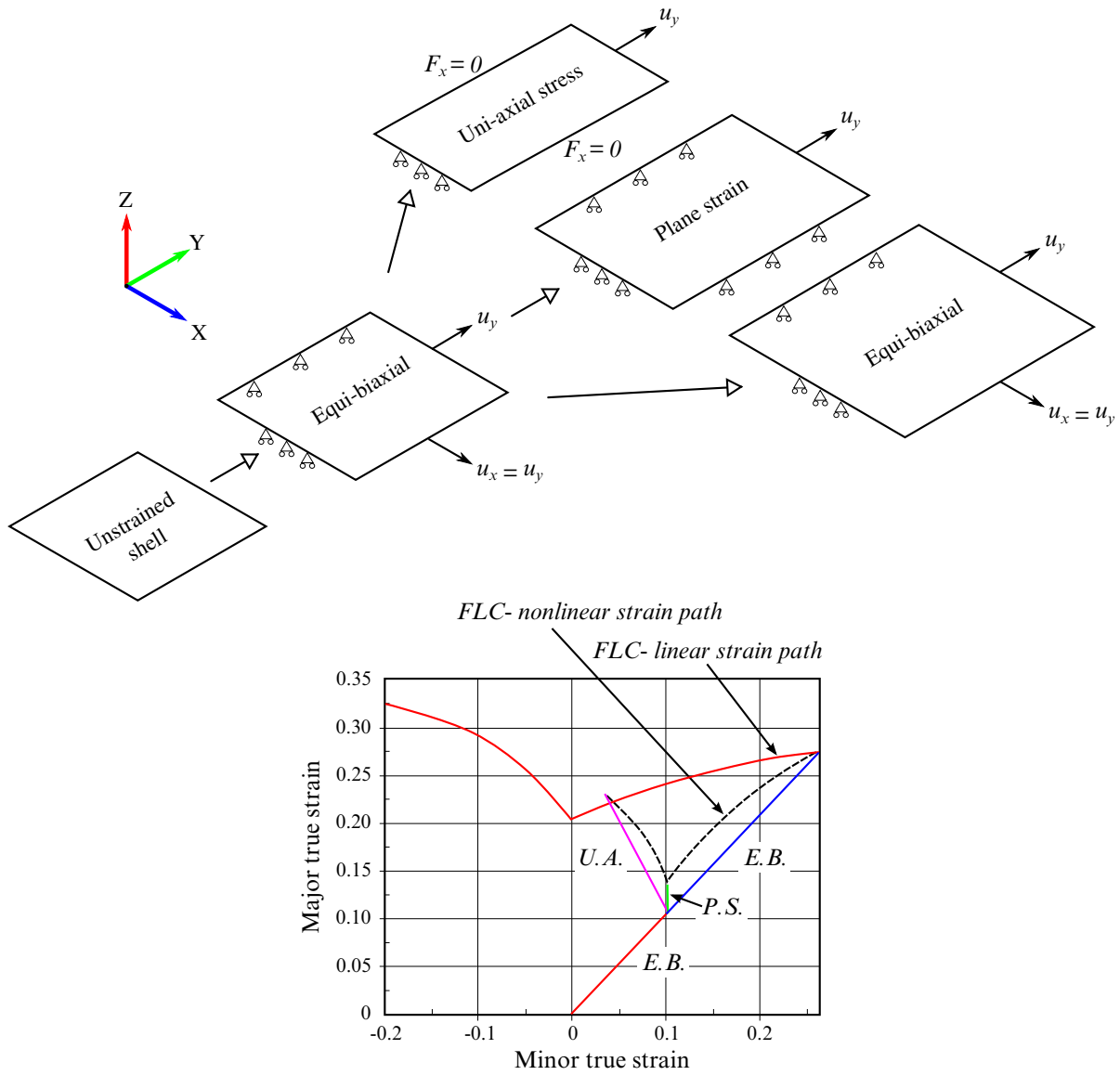

Figure 2-23. Nonlinear FLD prediction with equi-biaxial pre-straining.

*MAT_037

*MAT_TRANSVERSELY_ANISOTROPIC_ELASTIC_PLASTIC

*MAT_TRANSVERSELY_ANISOTROPIC_ELASTIC_PLASTIC_{OPTION}

Available option allows the change of Young's Modulus during the simulation:

<BLANK>

ECHANGE

A new option is available to allow for the calculation of the Formability Index (F.I.) which accounts for sheet metal forming problems with non-linear strain path:

NLP_FAILURE

This is Material Type 37. This model is for simulating sheet forming processes with anisotropic material. Only transverse anisotropy can be considered. Optionally an arbitrary dependency of stress and effective plastic strain can be defined via a load curve. This plasticity model is fully iterative and is available only for shell elements. Also see the remarks below.

Card 1	1	2	3	4	5	6	7	8
Variable	MID	RO	E	PR	SIGY	ETAN	R	HLCID
Type	A	F	F	F	F	F	F	F

Additional card for ECHANGE or NLP_FAILURE keyword options.

Card opt.	1	2	3	4	5	6	7	8
Variable	IDSCALE	EA	COE	ICFLD		STRAINLT		
Type	I	F	F	F		F		

VARIABLE

DESCRIPTION

MID	Material identification. A unique number or label not exceeding 8 characters must be specified.
RO	Mass density.
E	Young's modulus.
PR	Poisson's ratio.

VARIABLE	DESCRIPTION
SIGY	Yield stress.
ETAN	Plastic hardening modulus.
R	Anisotropic hardening parameter. When this value is set to a negative value, normal stresses (either from contact or applied pressure) are considered and *LOAD_SURFACE_STRESS must be used to capture the stresses. It is found in some cases this inclusion can improve forming simulation accuracy, and it applies to ELFORM of 2 and 16. The result of an example of using this feature is provided in remarks section and shown in Figure 2-27 .
HLCID	Load curve ID defining effective yield stress versus effective plastic strain.
IDSCALE	Load curve ID defining the scale factor for the Young's modulus change with respect to effective strain (if EA and COE are defined), this curve is not necessary).
EA, COE	Coefficients defining the Young's modulus with respect to the effective strain, EA is E^A and Coe is ζ (if IDSCALE is defined, these two parameters are not necessary).
ICFLD	Load curve ID for Forming Limit Diagram (FLD) definition.
STRAINLT	Critical strain value at which strain averaging is activated

Formulation:

Consider Cartesian reference axes which are parallel to the three symmetry planes of anisotropic behavior. Then, the yield function suggested by Hill [1948] can be written as:

$$F(\sigma_{22} - \sigma_{33})^2 + G(\sigma_{33} - \sigma_{11})^2 + H(\sigma_{11} - \sigma_{22})^2 + 2L\sigma_{23}^2 + 2M\sigma_{31}^2 + 2N\sigma_{12}^2 - 1 = 0$$

where σ_{y1} , σ_{y2} , and σ_{y3} , are the tensile yield stresses and σ_{y12} , σ_{y23} , and σ_{y31} are the shear yield stresses. The constants F, G, H, L, M, and N are related to the yield stress by:

$$2L = \frac{1}{\sigma_{y23}^2}$$

$$2M = \frac{1}{\sigma_{y31}^2}$$

$$2N = \frac{1}{\sigma_{y12}^2}$$

$$2F = \frac{1}{\sigma_{y2}^2} + \frac{1}{\sigma_{y3}^2} - \frac{1}{\sigma_{y1}^2}$$

$$2G = \frac{1}{\sigma_{y3}^2} + \frac{1}{\sigma_{y1}^2} - \frac{1}{\sigma_{y2}^2}$$

$$2H = \frac{1}{\sigma_{y1}^2} + \frac{1}{\sigma_{y2}^2} - \frac{1}{\sigma_{y3}^2} .$$

The isotropic case of von Mises plasticity can be recovered by setting:

$$F = G = H = \frac{1}{2\sigma_y^2}$$

and

$$L = M = N = \frac{3}{2\sigma_y^2}$$

For the particular case of transverse anisotropy, where properties do not vary in the x_1 - x_2 plane, the following relations hold:

$$2F = 2G = \frac{1}{\sigma_{y3}^2}$$

$$2H = \frac{2}{\sigma_y^2} - \frac{1}{\sigma_{y3}^2}$$

$$N = \frac{2}{\sigma_y^2} - \frac{1}{2} \frac{1}{\sigma_{y3}^2}$$

where it has been assumed that $\sigma_{y1} = \sigma_{y2} = \sigma_y$.

Letting $K = \frac{\sigma_y}{\sigma_{y3}}$, the yield criteria can be written as:

$$F(\sigma) = \sigma_e = \sigma_y,$$

where,

$$F(\sigma) \equiv \left[\sigma_{11}^2 + \sigma_{22}^2 + K^2 \sigma_{33}^2 - K^2 \sigma_{33} (\sigma_{11} + \sigma_{22}) - (2 - K^2) \sigma_{11} \sigma_{22} + 2L \sigma_y^2 (\sigma_{23}^2 + \sigma_{31}^2) + 2 \left(2 - \frac{1}{2} K^2 \right) \sigma_{12}^2 \right]^{1/2} .$$

The rate of plastic strain is assumed to be normal to the yield surface so $\dot{\epsilon}_{ij}^p$ is found from:

$$\dot{\epsilon}_{ij}^p = \lambda \frac{\partial F}{\partial \sigma_{ij}} .$$

Now consider the case of plane stress, where $\sigma_{33} = 0$. Also, define the anisotropy input parameter, R , as the ratio of the in-plane plastic strain rate to the out-of-plane plastic strain rate,

$$R = \frac{\dot{\epsilon}_{22}^p}{\dot{\epsilon}_{33}^p}.$$

It then follows that

$$R = \frac{2}{K^2} - 1.$$

Using the plane stress assumption and the definition of R , the yield function may now be written as:

$$F(\sigma) = \left[\sigma_{11}^2 + \sigma_{22}^2 - \frac{2R}{R+1} \sigma_{11} \sigma_{22} + 2 \frac{2R+1}{R+1} \sigma_{12}^2 \right]^{1/2}.$$

Discussion and ECHANGE:

It is noted that there are several differences between this model and other plasticity models for shell elements such as the model, `MAT_PIECEWISE_LINEAR_PLASTICITY`. First, the yield function for plane stress does not include the transverse shear stress components which are updated elastically, and, secondly, this model is always fully iterative. Consequently, in comparing results for the isotropic case where $R = 1.0$ with other isotropic model, differences in the results are expected, even though they are usually insignificant.

The Young's modulus has been assumed to be constant. Recently, some researchers have found that Young's modulus decreases with respect to the increase of effective strain. To accommodate this new observation, a new option of **ECHANGE** is added. There are two methods defining the change of Young's modulus change:

The first method is to use a curve to define the scale factor with respect to the effective strain. The value of this scale factor should decrease from 1 to 0 with the increase of effective strain.

The second method is to use a function as proposed by Yoshida [2003]:

$$E = E^0 - (E^0 - E^A)[1 - \exp(-\zeta \bar{\epsilon})].$$

An example of the option **ECHANGE** is provided in the remarks section of the `*MAT_125` manual pages.

A failure criterion for nonlinear strain paths:

When the option `NLP_FAILURE` is used, a necking failure criterion independent of strain path changes is activated. In sheet metal forming, as strain path history (plotted on in-plane

major and minor strain space) of an element becomes non-linear, the position and shape of a traditional strain-based Forming Limit Diagram (FLD) changes. This option provides a simple formability index (F.I.) which remains invariant regardless of the presence of the non-linear strain paths in the model, and can be used to identify if the element has reached its necking limit.

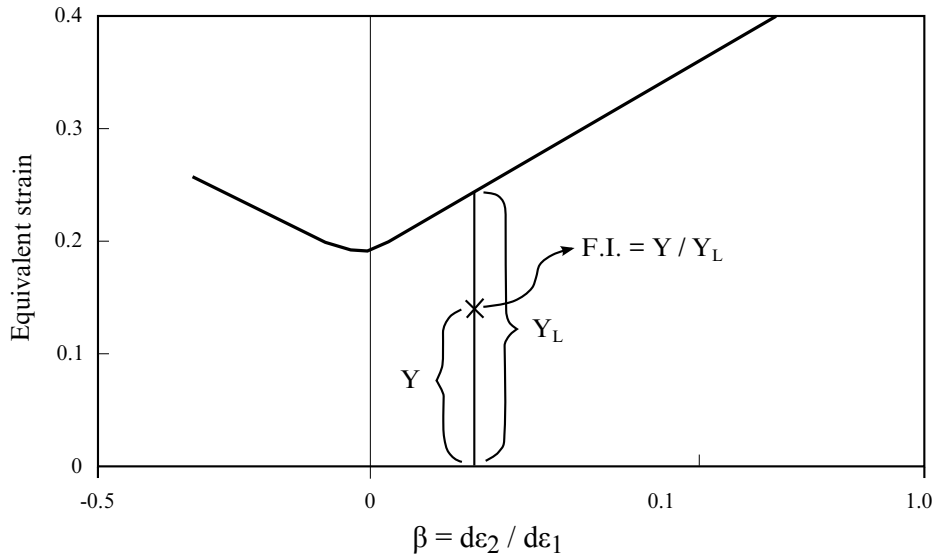

Figure 2-24. Calculation of F.I. based on critical effective strain method.

Formability index (F.I) is calculated, as illustrated in [Figure 2-24](#), for every element in the sheet blank throughout the simulation duration. The value of F.I. is 0.0 for virgin material and reaches maximum of 1.0 when the material fails. The theoretical background can be found in two papers: 1) T.B. Stoughton, X. Zhu, “Review of Theoretical Models of the Strain-Based FLD and their Relevance to the Stress-Based FLD, *International Journal of Plasticity*”, V. 20, Issues 8-9, P. 1463-1486, 2003; and 2) Danielle Zeng, Xinhai Zhu, Laurent B. Chappuis, Z. Cedric Xia, “A Path Independent Forming Limited Criterion for Sheet Metal Forming Simulations”, 2008 SAE Proceedings, Detroit MI, April, 2008.

Load curve input for FLD (ICFLD) follows keyword format in *DEFINE_CURVE, with abscissa values as minor strains and ordinate values as major strains.

Input of FLD can also be done using keyword *DEFINE_CURVE_FLC, where sheet metal thickness and strain hardening value ‘n’ are used. Detailed usage information can be found in the manual pages describing the keyword.

The formability index is output as a history variable #1 in D3PLOT files. It is activated by setting NEIPS to 1, in the second field of card 1 in keyword *DATABASE_EXTENT_BINARY. The history variable can be plotted in LS-PrePost4.0, accessible in *Post/FriComp*, under *Misc*.

When plotting the formability index, the pull-down menu under *FriComp* can be used to select minimum value 'Min' for necking failure determination. In *FriRang*, the option *None* is to be selected in the pull-down menu next to *Avg*. The index has a default range between 0.0 and 1.0. The non-linear forming limit is reached when the index reaches 1.0.

In addition, the evolution of the index throughout the simulation can be plotted in LS-PrePost4.0 under *Post/History* by *Element*, using the scroll bar to roll down the bottom to select *history var#1*. Furthermore, the strain path of an element can be plotted in *Post/FLD*, using option *Tracer*, by selecting the corresponding integration point representing the 'Min' index value in the *Position* pull-down menu.

Strains (and strain ratios) can be averaged to reduce noises, which in turn affect the calculation of the formability index. This is done through the variable STRAINLT. Under this user input value, various strains of every element are averaged through the calculation time and these averaged values are used to calculate the index. A reasonable STRAINLT value could be ranged from 5.0E-3 to 1.0E-2. Averaged strain ratios (minor/major) for every element are output through history variable #2, accessible through LS-PrePost4.0 under *Post/History* by *Element*, also through *FriComp*, under *MISC*. It is therefore necessary to set the value of NEIPS to 2 to have the variable written into D3PLOT files.

It is suggested that variable 'MAXINT' in *DATABASE_EXTENT_BINARY is set to the same value of variable 'NIP' in *SECTION_SHELL.

An example of a partial keyword input using this non-linear strain path failure criterion is provided below:

```
*MAT_TRANSVERSELY_ANISOTROPIC_ELASTIC_PLASTIC_NLP_FAILURE
$      MID      RO          E      PR      SIGY      ETAN          R  HLCID
      1  7.830E-09  2.070E+05   0.28    0.0        0.0        0.864   200
$      IDY          EA      COE      ICFLD      STRAINLT
                       891              1.0E-02

*DEFINE_CURVE
891
$ minor, major strains for FLD definition
-3.375000e-01   4.965000e-01
-2.750000e-01   4.340000e-01
-2.250000e-01   3.840000e-01
-1.840909e-01   3.430909e-01
-1.500000e-01   3.090000e-01
-1.211539e-01   2.801539e-01
-9.642858e-02   2.554286e-01
-7.500000e-02   2.340000e-01
-5.625001e-02   2.152500e-01
-3.970589e-02   1.987059e-01
-2.500000e-02   1.840000e-01

$$$$$$$$$$$$$$$$$$$$$$$$$$$$$$$$$$$$$$$$$$$$$$$$$$$$$$$$$$$$$$$$$$$$$$$$$$$$$$$$$$$$$$$$
$ load curve 200: Mat_037 property, DP600 NUMISHEET'05 Xnbr, Power law fit
$$$$$$$$$$$$$$$$$$$$$$$$$$$$$$$$$$$$$$$$$$$$$$$$$$$$$$$$$$$$$$$$$$$$$$$$$$$$$$$$$$$$$$$$
*DEFINE_CURVE
200
0.000,395.000
0.001,425.200
```

0.003, 440.300
0.004, 452.000
0.005, 462.400
0.006, 472.100

As shown in [Figure 2-25](#), typically, F.I contour can be plotted in *FriComp/Misc*, in LS-PrePost4.0. Strain paths of an individual element, or elements in an area can be plotted ([Figure 2-26](#) left) using the “Tracer” feature in the *FLD* menu. Finally, time history plot of the F.I. for elements selected can be plotted in *History* menu, [Figure 2-26](#) right.

Inclusion of normal stress in shell types 2 and 16:

When the R value is set to a negative value, normal stresses (either from contact or applied pressure) are considered. The keyword `*LOAD_SURFACE_STRESS` must be used to capture the stresses. In [Figure 2-27](#), a comparison of thinning contour is shown on a simple U-channel forming (one-half model) using negative and positive R values. Maximum thinning on the draw wall is slight higher in the negative R case than that in the positive R case.

Revision information:

The `NLP_FAILURE` option is implemented in explicit dynamic and is available in LS-DYNA R5 Revision 60925 and later releases. This option is also available in implicit static in R6 Revision 73241 and later releases.

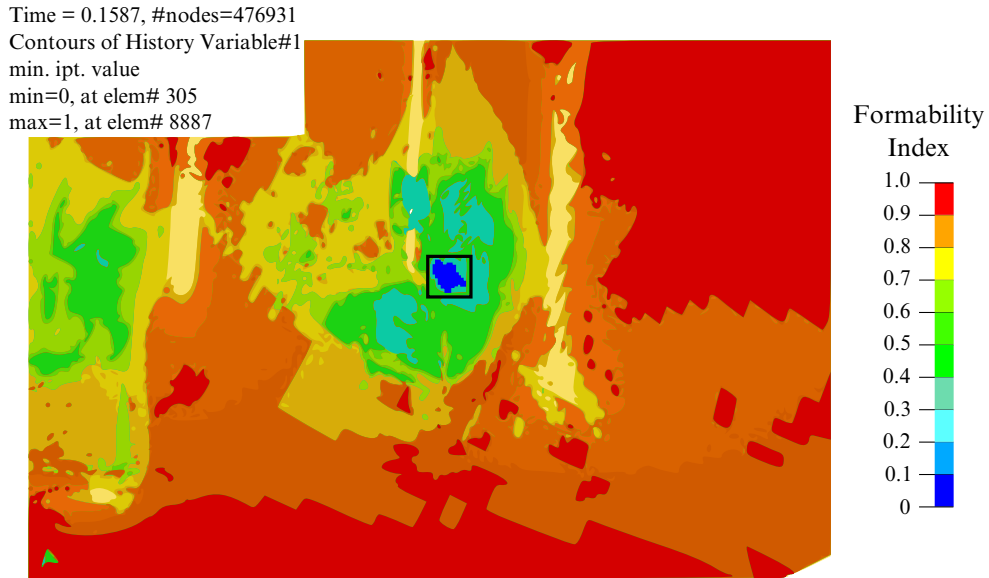
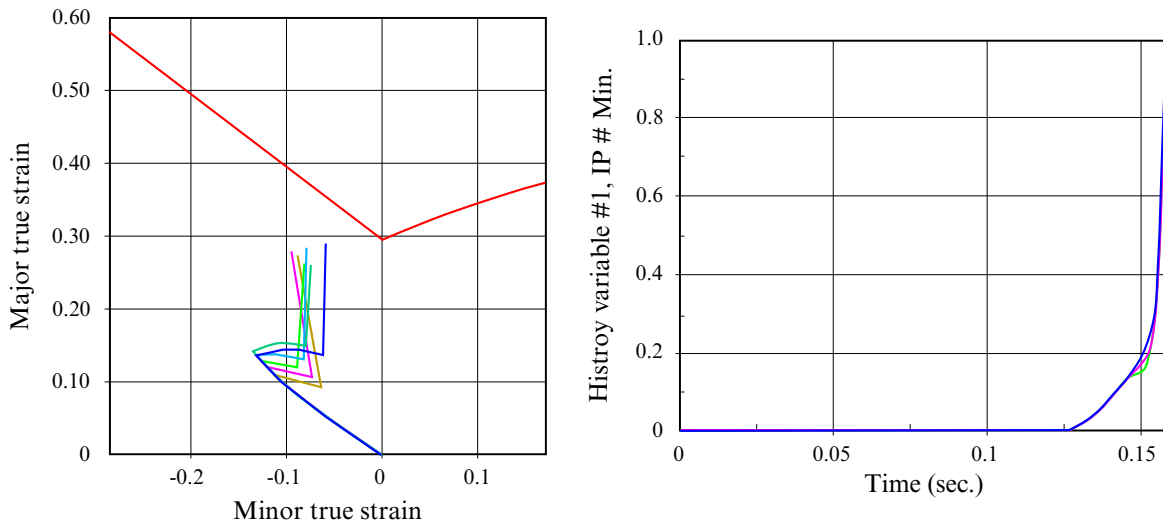

Figure 2-25. F.I. contour plot (min IP value, non-averaged).



Nonlinear strain paths of a few elements in the box

F.I. time history plots of the elements

Figure 2-26. Strain paths and F.I. history plot for elements in the black square box of [Figure 2-25](#).

Time=0.010271, #nodes=4594, #elem=4349
Contours of % Thickness Reduction based on current z-strain
min=0.0093799, at elem#42249
max=22.1816, at elem#39875

Time=0.010271, #nodes=4594, #elem=4349
Contours of % Thickness Reduction based on current z-strain
min=0.0597092, at elem#39814
max=21.2252, at elem#40457

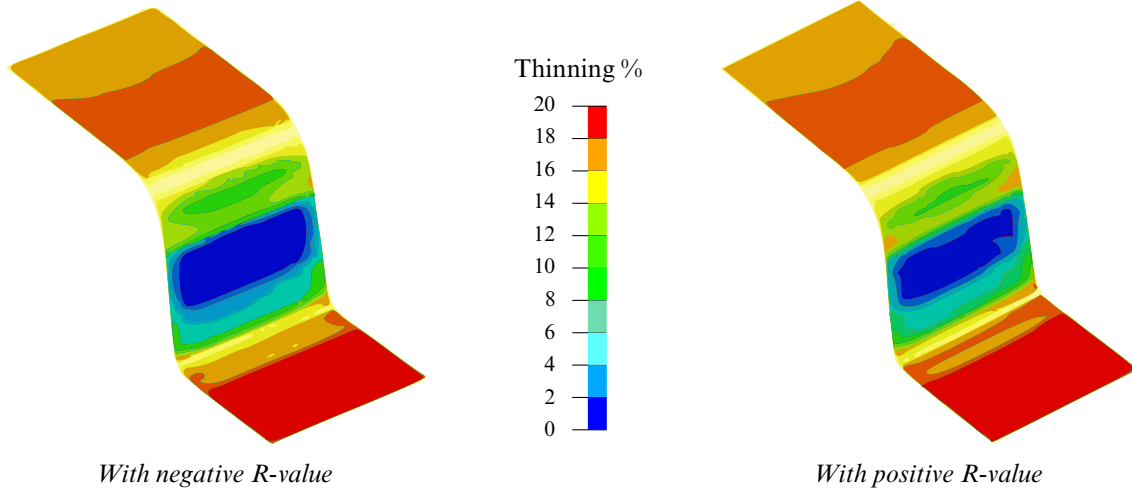

Figure 2-27. Thinning contour comparison.

*MAT_BLATZ-KO_FOAM

This is Material Type 38. This model is for the definition of rubber like foams of polyurethane. It is a simple one-parameter model with a fixed Poisson's ratio of .25.

Card 1	1	2	3	4	5	6	7	8
Variable	MID	RO	G	REF				
Type	A8	F	F	F				

VARIABLE**DESCRIPTION**

MID	Material identification. A unique number or label not exceeding 8 characters must be specified.
RO	Mass density.
G	Shear modulus.
REF	Use reference geometry to initialize the stress tensor. The reference geometry is defined by the keyword:*INITIAL_FOAM_REFERENCE_GEOMETRY (see there for more details). EQ.0.0: off, EQ.1.0: on.

Remarks:

The strain energy functional for the compressible foam model is given by

$$W = \frac{G}{2} \left(\frac{\text{II}}{\text{III}} + 2\sqrt{\text{III}} - 5 \right)$$

Blatz and Ko [1962] suggested this form for a 47 percent volume polyurethane foam rubber with a Poisson's ratio of 0.25. In terms of the strain invariants, I, II, and III, the second Piola-Kirchhoff stresses are given as

$$S^{ij} = G \left[(I\delta_{ij} - C_{ij}) \frac{1}{\text{III}} + \left(\sqrt{\text{III}} - \frac{\text{II}}{\text{III}} \right) C_{ij}^{-1} \right]$$

where C_{ij} is the right Cauchy-Green strain tensor. This stress measure is transformed to the Cauchy stress, σ_{ij} , according to the relationship

$$\sigma^{ij} = \text{III}^{-1/2} F_{ik} F_{jl} S_{lk}$$

where F_{ij} is the deformation gradient tensor.

*MAT_FLD_TRANSVERSELY_ANISOTROPIC

This is Material Type 39. This model is for simulating sheet forming processes with anisotropic material. Only transverse anisotropy can be considered. Optionally, an arbitrary dependency of stress and effective plastic strain can be defined via a load curve. A Forming Limit Diagram (FLD) can be defined using a curve and is used to compute the maximum strain ratio which can be plotted in LS-PrePost. This plasticity model is fully iterative and is available only for shell elements. Also see the notes below.

Card 1	1	2	3	4	5	6	7	8
Variable	MID	RO	E	PR	SIGY	ETAN	R	HLCID
Type	A8	F	F	F	F	F	F	F

Card 2	1	2	3	4	5	6	7	8
Variable	LCFLD							
Type	F							

VARIABLE	DESCRIPTION
MID	Material identification. A unique number or label not exceeding 8 characters must be specified.
RO	Mass density.
E	Young's modulus.
PR	Poisson's ratio.
SIGY	Yield stress.
ETAN	Plastic hardening modulus, see notes for model 37.
R	Anisotropic hardening parameter, see notes for model 37.
HLCID	Load curve ID defining effective stress versus effective plastic strain. The yield stress and hardening modulus are ignored with this option.

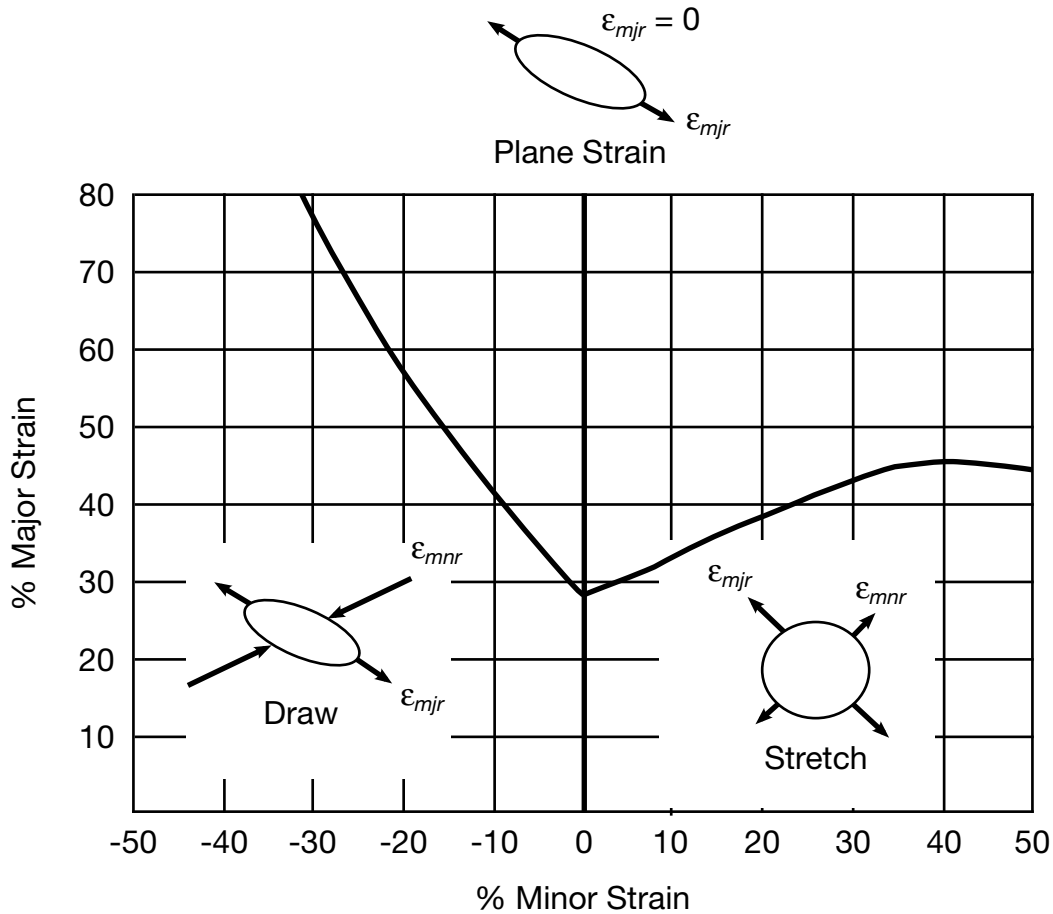

Figure 2-28. Forming limit diagram.

VARIABLE	DESCRIPTION
LCFLD	Load curve ID defining the Forming Limit Diagram. Minor strains in percent are defined as abscissa values and Major strains in percent are defined as ordinate values. The forming limit diagram is shown in Figure 2-28 . In defining the curve list pairs of minor and major strains starting with the left most point and ending with the right most point, see *DEFINE_CURVE.

Remarks:

See material model 37 for the theoretical basis. The first history variable is the maximum strain ratio:

$$\frac{\epsilon_{\text{major_workpiece}}}{\epsilon_{\text{major_fld}}}$$

corresponding to $\epsilon_{\text{minor_workpiece}}$.

***MAT_NONLINEAR_ORTHOTROPIC**

This is Material Type 40. This model allows the definition of an orthotropic nonlinear elastic material based on a finite strain formulation with the initial geometry as the reference. Failure is optional with two failure criteria available. Optionally, stiffness proportional damping can be defined. In the stress initialization phase, temperatures can be varied to impose the initial stresses. This model is only available for shell and solid elements. We do not recommend using this model at this time since it can be unstable especially if the stress-strain curves increase in stiffness with increasing strain.

Card 1	1	2	3	4	5	6	7	8
Variable	MID	R0	EA	EB	EC	PRBA	PRCA	PRCB
Type	A8	F	F	F	F	F	F	F
Default	none	none	none	none	none	none	none	none

Card 2	1	2	3	4	5	6	7	8
Variable	GAB	GBC	GCA	DT	TRAMP	ALPHA		
Type	F	F	F	F	F	F		
Default	none	none	none	0	0	0		

Card 3	1	2	3	4	5	6	7	8
Variable	LCIDA	LCIDB	EFAIL	DFAIL	CDAMP	AOPT	MACF	
Type	F	F	F	F	F	F	I	
Default	0.0	0.0	0.0	0.0	0.0	0.0	0	

Card 4	1	2	3	4	5	6	7	8
Variable	XP	YP	ZP	A1	A2	A3		
Type	F	F	F	F	F	F		

Card 5	1	2	3	4	5	6	7	8
Variable	V1	V2	V3	D1	D2	D3	BETA	
Type	F	F	F	F	F	F	F	

Optional Card 6 (Applies to Solid elements only)

Card 6	1	2	3	4	5	6	7	8
Variable	LCIDC	LCIDAB	LCIDBC	LCIDCA				
Type	F	F	F	F				
Default	optional	optional	optional	optional				

VARIABLE**DESCRIPTION**

MID	Material identification. A unique number or label not exceeding 8 characters must be specified.
RO	Mass density.
EA	E_a , Young's modulus in a-direction.
EB	E_b , Young's modulus in b-direction.
EC	E_c , Young's modulus in c-direction.
PRBA	ν_{ba} , Poisson's ratio ba.
PRCA	ν_{ca} , Poisson's ratio ca.
PRCB	ν_{cb} , Poisson's ratio cb.

VARIABLE	DESCRIPTION
GAB	G_{ab} , shear modulus ab.
GBC	G_{bc} , shear modulus bc.
GCA	G_{ca} , shear modulus ca.
DT	Temperature increment for isotropic stress initialization. This option can be used during dynamic relaxation.
TRAMP	Time to ramp up to the final temperature.
ALPHA	Thermal expansion coefficient.
LCIDA	Optional load curve ID defining the nominal stress versus strain along a-axis. Strain is defined as $\lambda_a - 1$ where λ_a is the stretch ratio along the a axis.
LCIDB	Optional load curve ID defining the nominal stress versus strain along b-axis. Strain is defined as $\lambda_b - 1$ where λ_b is the stretch ratio along the b axis.
EFAIL	Failure strain, $\lambda - 1$.
DTFAIL	Time step for automatic element erosion
CDAMP	Damping coefficient.
AOPT	Material axes option (see MAT_OPTIONTROPIC_ELASTIC for a more complete description): <ul style="list-style-type: none"> EQ.0.0: locally orthotropic with material axes determined by element nodes as shown in Figure 2-3 Nodes 1, 2, and 4 of an element are identical to the nodes used for the definition of a coordinate system as by *DEFINE_COORDINATE_NODES, and then, for shells only, rotated about the shell element normal by an angle BETA. EQ.1.0: locally orthotropic with material axes determined by a point in space and the global location of the element center; this is the a-direction. This option is for solid elements only. EQ.2.0: globally orthotropic with material axes determined by vectors defined below, as with *DEFINE_COORDINATE_VECTOR. EQ.3.0: locally orthotropic material axes determined by rotating

VARIABLE	DESCRIPTION
	<p>the material axes about the element normal by an angle, BETA, from a line in the plane of the element defined by the cross product of the vector \mathbf{v} with the element normal. The plane of a solid element is the midsurface between the inner surface and outer surface defined by the first four nodes and the last four nodes of the connectivity of the element, respectively.</p> <p>EQ.4.0: locally orthotropic in cylindrical coordinate system with the material axes determined by a vector \mathbf{v}, and an originating point, P, which define the centerline axis. This option is for solid elements only.</p> <p>LT.0.0: the absolute value of AOPT is a coordinate system ID number (CID on *DEFINE_COORDINATE_NODES, *DEFINE_COORDINATE_SYSTEM or *DEFINE_COORDINATE_VECTOR). Available in R3 version of 971 and later.</p>
MACF	<p>Material axes change flag:</p> <p>EQ.1: No change, default,</p> <p>EQ.2: switch material axes a and b,</p> <p>EQ.3: switch material axes a and c,</p> <p>EQ.4: switch material axes b and c.</p>
XP, YP, ZP	Define coordinates of point \mathbf{p} for AOPT = 1 and 4.
A1, A2, A3	$a_1 a_2 a_3$, define components of vector \mathbf{a} for AOPT = 2.
D1, D2, D3	$d_1 d_2 d_3$, define components of vector \mathbf{d} for AOPT = 2.
V1, V2, V3	$v_1 v_2 v_3$, define components of vector \mathbf{v} for AOPT = 3 and 4.
BETA	Material angle in degrees for AOPT = 0 (shells only) and 3. BETA may be overridden on the element card, see *ELEMENT_SHELL_BETA and *ELEMENT_SOLID_ORTHO..

The following input is optional and applies to **SOLID ELEMENTS** only

LCIDC	Load curve ID defining the nominal stress versus strain along c-axis. Strain is defined as $\lambda_c - 1$ where λ_c is the stretch ratio along the c axis.
-------	---

VARIABLE	DESCRIPTION
LCIDAB	Load curve ID defining the nominal ab shear stress versus ab-strain in the ab-plane. Strain is defined as the $\sin(\gamma_{ab})$ where γ_{ab} is the shear angle.
LCIDBC	Load curve ID defining the nominal ab shear stress versus ab-strain in the bc-plane. Strain is defined as the $\sin(\gamma_{bc})$ where γ_{bc} is the shear angle.
LCIDCA	Load curve ID defining the nominal ab shear stress versus ab-strain in the ca-plane. Strain is defined as the $\sin(\gamma_{ca})$ where γ_{bc} is the shear angle.

***MAT_USER_DEFINED_MATERIAL_MODELS**

These are Material Types 41-50. The user must provide a material subroutine. See also Appendix A. This keyword input is used to define material properties for the subroutine. Isotropic, anisotropic, thermal, and hyperelastic material models with failure can be handled.

Card 1	1	2	3	4	5	6	7	8
Variable	MID	RO	MT	LMC	NHV	IORTHO/ ISPOT	IBULK	IG
Type	A8	F	I	I	I	I	I	I

Card 2	1	2	3	4	5	6	7	8
Variable	IVECT	IFAIL	ITHERM	IHYPER	IEOS	LMCA		
Type	I	I	I	I	I	I		

Additional card for IORTHO = 1.

Card 3	1	2	3	4	5	6	7	8
Variable	AOPT	MACF	XP	YP	ZP	A1	A2	A3
Type	F	I	F	F	F	F	F	F

Card 4	1	2	3	4	5	6	7	8
Variable	V1	V2	V3	D1	D2	D3	BETA	IEVTS
Type	F	F	F	F	F	F	F	I

Define LMC material parameters using 8 parameters per card.

Card	1	2	3	4	5	6	7	8
Variable	P1	P2	P3	P4	P5	P6	P7	P8
Type	F	F	F	F	F	F	F	F

Define LMCA material parameters using 8 parameters per card.

Card	1	2	3	4	5	6	7	8
Variable	P1	P2	P3	P4	P5	P6	P7	P8
Type	F	F	F	F	F	F	F	F

VARIABLE	DESCRIPTION
MID	Material identification. A unique number or label not exceeding 8 characters must be specified.
RO	Mass density.
MT	User material type (41-50 inclusive). A number between 41 and 50 has to be chosen. If $MT < 0$, subroutine rwumat in dyn21.f is called, where the material parameter reading can be modified. WARNING: If two or more materials in an input deck share the same MT value, those materials also share values of other variables on Cards 1 and 2 excluding MID. Those shared values are taken from the first material where the common MT is encountered.
LMC	Length of material constant array which is equal to the number of material constants to be input. (see remark 4)
NHV	Number of history variables to be stored, see Appendix A. When the model is to be used with an equation of state, NHV must be increased by 4 to allocate the storage required by the equation of state.
IORTHO/ ISPOT	EQ.1: if the material is orthotropic. EQ.2: if material is used with spot weld thinning. EQ.3: if material is orthotropic and used with spot weld thinning

VARIABLE	DESCRIPTION
IBULK	Address of bulk modulus in material constants array, see Appendix A.
IG	Address of shear modulus in material constants array, see Appendix A.
IVECT	Vectorization flag (on = 1). A vectorized user subroutine must be supplied.
IFAIL	Failure flag. EQ.0: No failure, EQ.1: Allows failure of shell and solid elements, LT.0: IFAIL is the address of NUMINT in the material constants array. NUMINT is defined as the number of failed integration points that will trigger element deletion. This option applies only to shell and solid elements (release 5 of v.971).
ITHERM	Temperature flag (on = 1). Compute element temperature.
IHYPER	Deformation gradient flag (on = 1 or -1, or 3). Compute deformation gradient, see Appendix A.
IEOS	Equation of state (on = 1).
LMCA	Length of additional material constant array.
AOPT	Material axes option (see *MAT_002 for a more complete description): EQ.0.0: locally orthotropic with material axes determined by element nodes 1, 2, and 4, as with *DEFINE_COORDINATE_NODES, and then, for shells only, rotated about the shell element normal by an angle BETA. EQ.1.0: locally orthotropic with material axes determined by a point in space and the global location of the element center; this is the a-direction. This option is for solid elements only. EQ.2.0: globally orthotropic with material axes determined by vectors defined below, as with *DEFINE_COORDINATE_VECTOR. EQ.3.0: locally orthotropic material axes determined by rotating

VARIABLE	DESCRIPTION
	<p>the material axes about the element normal by an angle, BETA, from a line in the plane of the element defined by the cross product of the vector v with the element normal.</p> <p>EQ.4.0: locally orthotropic in cylindrical coordinate system with the material axes determined by a vector v, and an originating point, p, which define the centerline axis. This option is for solid elements only.</p> <p>LT.0.0: the absolute value of AOPT is a coordinate system ID number (CID on *DEFINE_COORDINATE_NODES, *DEFINE_COORDINATE_SYSTEM or *DEFINE_COORDINATE_VECTOR). Available in R3 version of 971 and later.</p>
MACF	<p>Material axes change flag for brick elements for quick changes:</p> <p>EQ.1: No change, default,</p> <p>EQ.2: switch material axes a and b,</p> <p>EQ.3: switch material axes a and c,</p> <p>EQ.4: switch material axes b and c.</p>
XP YP ZP	Coordinates of point p for AOPT = 1 and 4.
A1 A2 A3	Components of vector a for AOPT = 2.
V1 V2 V3	Components of vector v for AOPT = 3 and 4.
D1 D2 D3	Components of vector d for AOPT = 2.
BETA	Material angle in degrees for AOPT = 0 (shells only) and 3. BETA may be overridden on the element card, see *ELEMENT_SHELL_BETA and *ELEMENT_SOLID_ORTHO.
IEVTS	Address of E(a) for orthotropic material in thick shell formulation 5 (see remark 6).
P1	First material parameter.
P2	Second material parameter.
P3	Third material parameter.
P4	Fourth material parameter.

VARIABLE	DESCRIPTION
⋮	⋮
PLMC	LMCth material parameter.

Remarks:

1. The material model for the cohesive element (solid element type 19) uses the first two material parameters to set flags for the element formulation. P1 controls how the density is used to calculate the mass. The cohesive element formulation permits the element to have zero or negative volume. Tractions are calculated on a surface midway between the surfaces defined by nodes 1-2-3-4 and 5-6-7-8. If P1 is set to 1.0, then the density is per unit area of the midsurface instead of per unit volume. The second parameter, P2, specifies the number of integration points (one to four) that are required to fail for the element to fail. If it is zero, the element won't fail regardless of the value of IFAIL. The recommended value of P2 is 1.
2. The cohesive element currently only uses MID, RO, MT, LMC, NHV, IFAIL and IVECT in addition to the material parameters.
3. See Appendix R for the specifics of the umat subroutine requirements for the cohesive element.
4. If IORTHO = 0, LMC must be ≤ 48 . If IORTHO = 1, LMC must be ≤ 40 . If more material constants are needed, LMCA may be used to create an additional material constant array. There is no limit on the size of LMCA.
5. If the user-defined material is used for beam or brick element spot welds that are tied to shell elements, and SPOTHIN > 0 on *CONTROL_CONTACT, then spot weld thinning will be done for those shells if ISPOT = 2. Otherwise, it will not be done.
6. IEVTS is optional and is used only by thick shell formulation 5. It points to the position of E(a) in the material constants array. Following E(a), the next 5 material constants must be E(b), E(c), v(ba), v(ca), and v(cb). This data enables thick shell formulation 5 to calculate an accurate thickness strain, otherwise the thickness strain will be based on the elastic constants pointed to by IBULK and IG.

***MAT_BAMMAN**

This is Material Type 51. It allows the modeling of temperature and rate dependent plasticity with a fairly complex model that has many input parameters [Bamman 1989].

Card 1	1	2	3	4	5	6	7	8
Variable	MID	RO	E	PR	T	HC		
Type	A8	F	F	F	F	F		

Card 2	1	2	3	4	5	6	7	8
Variable	C1	C2	C3	C4	C5	C6	C7	C8
Type	F	F	F	F	F	F	F	F

Card 3	1	2	3	4	5	6	7	8
Variable	C9	C10	C11	C12	C13	C14	C15	C16
Type	F	F	F	F	F	F	F	F

Card 4	1	2	3	4	5	6	7	8
Variable	C17	C18	A1	A2	A4	A5	A6	KAPPA
Type	F	F	F	F	F	F	F	F

VARIABLE**DESCRIPTION**

MID	Material identification. A unique number or label not exceeding 8 characters must be specified.
RO	Mass density.
E	Young's modulus (psi)

VARIABLE	DESCRIPTION
PR	Poisson's ratio
T	Initial temperature (°R, degrees Rankine)
HC	Heat generation coefficient (°R _{psi})
C1	Psi
C2	°R
C3	Psi
C4	°R
C5	1/s
C6	°R
C7	1/psi
C8	°R
C9	Psi
C10	°R
C11	1/psi-s
C12	°R
C13	1/psi
C14	°R
C15	psi
C16	°R
C17	1/psi-s
C18	°R
A1	α_1 , initial value of internal state variable 1
A2	α_2 , initial value of internal state variable 2. Note: $\alpha_3 = -(\alpha_1 + \alpha_2)$

VARIABLE	DESCRIPTION
A3	α_4 , initial value of internal state variable 3
A4	α_5 , initial value of internal state variable 4
A5	α_6 , initial value of internal state variable 5
KAPPA	κ , initial value of internal state variable 6

Unit Conversion Table

	Sec \times psi \times $^{\circ}$ R	sec \times MPa \times $^{\circ}$ R	sec \times MPA \times $^{\circ}$ K
C1		$\times 1/145$	$\times 1/145$
C2		—	$\times 5/9$
C3		$\times 1/145$	$\times 1/145$
C4		—	$\times 5/9$
C5		—	—
C6		—	$\times 5/9$
C7		$\times 145$	$\times 145$
C8		—	$\times 5/9$
C9		$\times 1/145$	$\times 1/145$
C10		—	$\times 5/9$
C11		$\times 145$	$\times 145$
C12		—	$\times 5/9$
C13		$\times 145$	$\times 145$
C14		—	$\times 5/9$
C15		$\times 1/145$	$\times 1/145$
C16		—	$\times 5/9$
C17		$\times 145$	$\times 145$
C18		—	$\times 5/9$
C0 = HC		$\times 145$	$\times (145)^{(5/9)}$
E		$\times 1/145$	$\times 1/145$
ν		—	—
T		—	$\times 5/9$

Remarks:

The kinematics associated with the model are discussed in references [Hill 1948, Bammann and Aifantis 1987, Bammann 1989]. The description below is taken nearly verbatim from Bammann [1989].

With the assumption of linear elasticity we can write,

$$\overset{\circ}{\sigma} = \lambda \operatorname{tr}(D^e) \mathbf{1} + 2\mu D^e$$

where the Cauchy stress σ is convected with the elastic spin W^e as,

$$\overset{\circ}{\sigma} = \dot{\sigma} - W^e \sigma + \sigma W^e$$

This is equivalent to writing the constitutive model with respect to a set of directors whose direction is defined by the plastic deformation [Bammann and Aifantis 1987, Bammann and Johnson 1987]. Decomposing both the skew symmetric and symmetric parts of the velocity gradient into elastic and plastic parts we write for the elastic stretching D^e and the elastic spin W^e ,

$$D^e = D - D^p - D^{th}, W^e = W = W^p.$$

Within this structure it is now necessary to prescribe an equation for the plastic spin W^p in addition to the normally prescribed flow rule for D^p and the stretching due to the thermal expansion D^{th} . As proposed, we assume a flow rule of the form,

$$D^p = f(T) \sinh \left[\frac{|\xi| - \kappa - Y(T)}{V(T)} \right] \frac{\xi'}{|\xi'|}$$

where T is the temperature, κ is the scalar hardening variable, and ξ' is the difference between the deviatoric Cauchy stress σ' and the tensor variable α' ,

$$\xi' = \sigma' - \alpha'$$

and $f(T)$, $Y(T)$, $V(T)$ are scalar functions whose specific dependence upon the temperature is given below. Assuming isotropic thermal expansion and introducing the expansion coefficient \dot{A} , the thermal stretching can be written,

$$D^{th} = \dot{A} \mathbf{1}$$

The evolution of the internal variables α and κ are prescribed in a hardening minus recovery format as,

$$\dot{\alpha} = h(T) D^p - [r_d(T) |D^p| + r_s(T)] |\alpha| \alpha,$$

$$\dot{\kappa} = H(T) D^p - [R_d(T) |D^p| + R_s(T)] \kappa^2$$

where h and H are the hardening moduli, $r_s(T)$ and $R_s(T)$ are scalar functions describing the diffusion controlled 'static' or 'thermal' recovery, and $r_d(T)$ and $R_d(T)$ are the functions describing dynamic recovery.

If we assume that $W^p = 0$, we recover the Jaumann stress rate which results in the prediction of an oscillatory shear stress response in simple shear when coupled with a Prager kinematic hardening assumption [Johnson and Bammann 1984]. Alternatively we can choose,

$$W^p = R^T \dot{U} U^{-1} R,$$

which recovers the Green-Naghdi rate of Cauchy stress and has been shown to be equivalent to Mandel's isoclinic state [Bammann and Aifantis 1987]. The model employing this rate allows a reasonable prediction of directional softening for some materials, but in

general under-predicts the softening and does not accurately predict the axial stresses which occur in the torsion of the thin walled tube.

The final equation necessary to complete our description of high strain rate deformation is one which allows us to compute the temperature change during the deformation. In the absence of a coupled thermo-mechanical finite element code we assume adiabatic temperature change and follow the empirical assumption that 90 -95% of the plastic work is dissipated as heat. Hence,

$$\dot{T} = \frac{.9}{\rho C_v} (\sigma \cdot D^p),$$

where ρ is the density of the material and C_v the specific heat.

In terms of the input parameters the functions defined above become:

$V(T) = C1 \exp(-C2/T)$	$h(T) = C9 \exp(C10/T)$
$Y(T) = C3 \exp(C4/T)$	$rs(T) = C11 \exp(-C12/T)$
$f(T) = C5 \exp(-C6/T)$	$RD(T) = C13 \exp(-C14/T)$
$rd(T) = C7 \exp(-C8/T)$	$H(T) = C15 \exp(C16/T)$
	$RS(T) = C17 \exp(-C18/T)$

and the heat generation coefficient is

$$HC = \frac{0.9}{\rho C_v}.$$

***MAT_BAMMAN_DAMAGE**

This is Material Type 52. This is an extension of model 51 which includes the modeling of damage. See Bamman et al. [1990].

Card 1	1	2	3	4	5	6	7	8
Variable	MID	R0	E	PR	T	HC		
Type	A8	F	F	F	F	F		

Card 2	1	2	3	4	5	6	7	8
Variable	C1	C2	C3	C4	C5	C6	C7	C8
Type	F	F	F	F	F	F	F	F

Card 3	1	2	3	4	5	6	7	8
Variable	C9	C10	C11	C12	C13	C14	C15	C16
Type	F	F	F	F	F	F	F	F

Card 4	1	2	3	4	5	6	7	8
Variable	C17	C18	A1	A2	A3	A4	A5	A6
Type	F	F	F	F	F	F	F	F

Card 5	1	2	3	4	5	6	7	8
Variable	N	D0	FS					
Type	F	F	F					

VARIABLE	DESCRIPTION
MID	Material identification. A unique number or label not exceeding 8 characters must be specified.
RO	Mass density
E	Young's modulus (psi)
PR	Poisson's ratio
T	Initial temperature (°R, degrees Rankine)
HC	Heat generation coefficient ($^{\circ}\text{R}_{\text{psi}}$)
C1	Psi
C2	°R
C3	Psi
C4	°R
C5	1/s
C6	°R
C7	1/psi
C8	°R
C9	Psi
C10	°R
C11	1/psi-s
C12	°R
C13	1/psi
C14	°R
C15	psi
C16	°R
C17	1/psi-s

VARIABLE	DESCRIPTION
C18	°R
A1	α_1 , initial value of internal state variable 1
A2	α_2 , initial value of internal state variable 2
A3	α_3 , initial value of internal state variable 3
A4	α_4 , initial value of internal state variable 4
A5	α_5 , initial value of internal state variable 5
A6	α_6 , initial value of internal state variable 6
N	Exponent in damage evolution
D0	Initial damage (porosity)
FS	Failure strain for erosion.

Remarks:

The evolution of the damage parameter, ϕ is defined by Bammann et al. [1990]

$$\dot{\phi} = \beta \left[\frac{1}{(1 - \phi)^N} - (1 - \phi) \right]^{|D^p|}$$

in which

$$\beta = \sinh \left[\frac{2(2N - 1)p}{(2N - 1)\bar{\sigma}} \right]$$

where p is the pressure and $\bar{\sigma}$ is the effective stress.

***MAT_CLOSED_CELL_FOAM**

This is Material Type 53. This allows the modeling of low density, closed cell polyurethane foam. It is for simulating impact limiters in automotive applications. The effect of the confined air pressure is included with the air being treated as an ideal gas. The general behavior is isotropic with uncoupled components of the stress tensor.

Card 1	1	2	3	4	5	6	7	8
Variable	MID	RO	E	A	B	C	P0	PHI
Type	A8	F	F	F	F	F	F	F

Card 2	1	2	3	4	5	6	7	8
Variable	GAMA0	LCID						
Type	F	I						

VARIABLE**DESCRIPTION**

MID	Material identification. A unique number or label not exceeding 8 characters must be specified.
RO	Mass density
E	Young's modulus
A	a, factor for yield stress definition, see notes below.
B	b, factor for yield stress definition, see notes below.
C	c, factor for yield stress definition, see notes below.
P0	Initial foam pressure, P_0
PHI	Ratio of foam to polymer density, ϕ
GAMA0	Initial volumetric strain, γ_0 . The default is zero.

VARIABLE	DESCRIPTION
LCID	Optional load curve defining the von Mises yield stress versus $-\gamma$. If the load curve ID is given, the yield stress is taken from the curve and the constants a, b, and c are not needed. The load curve is defined in the positive quadrant, i.e., positive values of γ are defined as negative values on the abscissa.

Remarks:

A rigid, low density, closed cell, polyurethane foam model developed at Sandia Laboratories [Neilsen, Morgan and Krieg 1987] has been recently implemented for modeling impact limiters in automotive applications. A number of such foams were tested at Sandia and reasonable fits to the experimental data were obtained.

In some respects this model is similar to the crushable honeycomb model type 26 in that the components of the stress tensor are uncoupled until full volumetric compaction is achieved. However, unlike the honeycomb model this material possesses no directionality but includes the effects of confined air pressure in its overall response characteristics.

$$\sigma_{ij} = \sigma_{ij}^{sk} - \delta_{ij}\sigma^{air}$$

where σ_{ij}^{sk} is the skeletal stress and σ^{air} is the air pressure computed from the equation:

$$\sigma^{air} = -\frac{p_0\gamma}{1 + \gamma - \phi}$$

where p_0 is the initial foam pressure, usually taken as the atmospheric pressure, and γ defines the volumetric strain

$$\gamma = V - 1 + \gamma_0$$

where V is the relative volume, defined as the ratio of the current volume to the initial volume, and γ_0 is the initial volumetric strain, which is typically zero. The yield condition is applied to the principal skeletal stresses, which are updated independently of the air pressure. We first obtain the skeletal stresses:

$$\sigma_{ij}^{sk} = \sigma_{ij} + \sigma_{ij}\sigma^{air}$$

and compute the trial stress, σ^{skt}

$$\sigma_{ij}^{skt} = \sigma_{ij}^{sk} + E \dot{\epsilon}_{ij} \Delta t$$

where E is Young's modulus. Since Poisson's ratio is zero, the update of each stress component is uncoupled and $2G = E$ where G is the shear modulus. The yield condition is applied to the principal skeletal stresses such that, if the magnitude of a principal trial stress component, σ_i^{skt} , exceeds the yield stress, σ_y , then

$$\sigma_i^{\text{sk}} = \min(\sigma_y, |\sigma_i^{\text{skt}}|) \frac{\sigma_i^{\text{skt}}}{|\sigma_i^{\text{skt}}|}$$

The yield stress is defined by

$$\sigma_y = a + b(1 + c\gamma)$$

where a, b, and c are user defined input constants and γ is the volumetric strain as defined above. After scaling the principal stresses they are transformed back into the global system and the final stress state is computed

$$\sigma_{ij} = \sigma_{ij}^{\text{sk}} - \delta_{ij}\sigma^{\text{air}}.$$

***MAT_ENHANCED_COMPOSITE_DAMAGE**

These are Material Types 54-55 which are enhanced versions of the composite model material type 22. Arbitrary orthotropic materials, e.g., unidirectional layers in composite shell structures can be defined. Optionally, various types of failure can be specified following either the suggestions of [Chang and Chang 1987b] or [Tsai and Wu 1971]. In addition special measures are taken for failure under compression. See [Matzenmiller and Schweizerhof 1991].

By using the user defined integration rule, see *INTEGRATION_SHELL, the constitutive constants can vary through the shell thickness. For all shells, except the DKT formulation, laminated shell theory can be activated to properly model the transverse shear deformation. Lamination theory is applied to correct for the assumption of a uniform constant shear strain through the thickness of the shell.

For sandwich shells where the outer layers are much stiffer than the inner layers, the response will tend to be too stiff unless lamination theory is used. To turn on lamination theory see *CONTROL_SHELL. A damage model for transverse shear strain is added since version 971 release R4 to model interlaminar shear failure (thin shells only). The definition of minimum stress limits is available since version 971 R5 (thin shells only).

Card 1	1	2	3	4	5	6	7	8
Variable	MID	RO	EA	EB	EC	PRBA	PRCA	PRCB
Type	A8	F	F	F	F	F	F	F

Card 2	1	2	3	4	5	6	7	8
Variable	GAB	GBC	GCA	(KF)	AOPT			
Type	F	F	F	F	F			

Card 3	1	2	3	4	5	6	7	8
Variable				A1	A2	A3	MANGLE	
Type				F	F	F	F	

Card 4	1	2	3	4	5	6	7	8
Variable	V1	V2	V3	D1	D2	D3	DFAILM	DFAILS
Type	F	F	F	F	F	F	F	F

Card 5	1	2	3	4	5	6	7	8
Variable	TFAIL	ALPH	SOFT	FBRT	YCFAC	DFAILT	DFAILC	EFS
Type	F	F	F	F	F	F	F	F

Card 6	1	2	3	4	5	6	7	8
Variable	XC	XT	YC	YT	SC	CRIT	BETA	
Type	F	F	F	F	F	F	F	

Optional Card 7 (starting with version 971 release R4, thin shells only)

Card 7	1	2	3	4	5	6	7	8
Variable	PFL	EPSF	EPSR	TSMD	SOFT2			
Type	F	F	F	F	F			

Optional Card 8 (starting with version 971 release R5, thin shells only)

Card 8	1	2	3	4	5	6	7	8
Variable	SLIMT1	SLIMC1	SLIMT2	SLIMC2	SLIMS	NCYRED	SOFTG	
Type	F	F	F	F	F	F	F	

Optional Card 9 (CRIT = 54 and thin shells only)

Card 9	1	2	3	4	5	6	7	8
Variable	LCXC	LCXT	LCYC	LCYT	LCSC	DT		
Type	I	I	I	I	I	F		

VARIABLE**DESCRIPTION**

MID	Material identification. A unique number or label not exceeding 8 characters must be specified.
RO	Mass density
EA	E_a , Young's modulus - longitudinal direction
EB	E_b , Young's modulus - transverse direction
EC	E_c , Young's modulus - normal direction
PRBA	ν_{ba} , Poisson's ratio ba
PRCA	ν_{ca} , Poisson's ratio ca
PRCB	ν_{cb} , Poisson's ratio cb
GAB	G_{ab} , shear modulus ab
GBC	G_{bc} , shear modulus bc
GCA	G_{ca} , shear modulus ca
(KF)	Bulk modulus of failed material (not used)
AOPT	Material axes option (see <i>MAT_OPTION TROPIC_ELASTIC</i> for a more complete description): <ul style="list-style-type: none"> EQ.0.0: locally orthotropic with material axes determined by element nodes 1, 2, and 4, as with <i>*DEFINE_COORDINATE_NODES</i>, and then, for shells only, rotated about the shell element normal by an angle MANGLE. EQ.2.0: globally orthotropic with material axes determined by vectors defined below, as with <i>*DEFINE_COORDINATE_VECTOR</i>. EQ.3.0: locally orthotropic material axes determined by rotating

VARIABLE	DESCRIPTION
	<p>the material axes about the element normal by an angle (MANGLE) from a line in the plane of the element defined by the cross product of the vector \mathbf{v} with the element normal.</p> <p>LT.0.0: the absolute value of AOPT is a coordinate system ID number (CID on *DEFINE_COORDINATE_NODES, *DEFINE_COORDINATE_SYSTEM or *DEFINE_COORDINATE_VECTOR). Available in R3 version of 971 and later.</p>
A1 A2 A3	Define components of vector \mathbf{a} for AOPT = 2.
V1 V2 V3	Define components of vector \mathbf{v} for AOPT = 3.
D1 D2 D3	Define components of vector \mathbf{d} for AOPT = 2.
MANGLE	Material angle in degrees for AOPT = 0 (shells only) and 3. MANGLE may be overridden on the element card, see *ELEMENT_SHELL_BETA and *ELEMENT_SOLID_ORTHO.
DFAILM	Maximum strain for matrix straining in tension or compression (active only for MAT_054 and only if DFAILT > 0). The layer in the element is completely removed after the maximum strain in the matrix direction is reached. The input value is always positive.
DFAILS	Maximum tensorial shear strain (active only for MAT_054 and only if DFAILT > 0). The layer in the element is completely removed after the maximum shear strain is reached. The input value is always positive.
TFAIL	<p>Time step size criteria for element deletion:</p> <p>$t_{fail} \leq 0$: no element deletion by time step size. The crash-front algorithm only works if t_{fail} is set to a value above zero.</p> <p>$0 < t_{fail} \leq 0.1$: element is deleted when its time step is smaller than the given value,</p> <p>$t_{fail} > 0.1$: element is deleted when the quotient of the actual time step and the original time step drops below the given value.</p>
ALPH	Shear stress parameter for the nonlinear term, see Material 22.

VARIABLE	DESCRIPTION
SOFT	Softening reduction factor for material strength in crashfront elements (default = 1.0). TFAIL must be greater than zero to activate this option.
FBRT	Softening for fiber tensile strength: EQ.0.0: tensile strength = XT GT.0.0: tensile strength = XT, reduced to XT × FBRT after failure has occurred in compressive matrix mode.
YCFAC	Reduction factor for compressive fiber strength after matrix compressive failure (MAT_054 only). The compressive strength in the fiber direction after compressive matrix failure is reduced to: $X_c = YCFAC \times Y_{c'} \quad (\text{default: } YCFAC = 2.0)$
DFAILT	Maximum strain for fiber tension (MAT_054 only). (Maximum 1 = 100% strain). The layer in the element is completely removed after the maximum tensile strain in the fiber direction is reached. If a nonzero value is given for DFAILT, a nonzero, negative value must also be provided for DFAILC.
DFAILC	Maximum strain for fiber compression (MAT_054 only). (Maximum -1 = 100% compression). The layer in the element is completely removed after the maximum compressive strain in the fiber direction is reached. The input value should be negative and is required if DFAILT > 0.
EFS	Effective failure strain (MAT_054 only).
XC	Longitudinal compressive strength (absolute value is used). GE.0.0: Poisson effect (PRBA) after failure is active. LT.0.0: Poisson effect after failure is not active, i.e. PRBA = 0.
XT	Longitudinal tensile strength, see below.
YC	Transverse compressive strength, b-axis (positive value), see below.
YT	Transverse tensile strength, b-axis, see below.
SC	Shear strength, ab plane, see below.

VARIABLE	DESCRIPTION
CRIT	Failure criterion (material number): EQ.54.0: Chang matrix failure criterion (as Material 22) (default), EQ.55.0: Tsai-Wu criterion for matrix failure.
BETA	Weighting factor for shear term in tensile fiber mode (MAT_054 only). ($0.0 \leq \text{BETA} \leq 1.0$)
PFL	Percentage of layers which must fail until crashfront is initiated. E.g. PFL = 80.0, then 80 % of layers must fail until strengths are reduced in neighboring elements. Default: all layers must fail. A single layer fails if 1 in-plane IP fails (PFL > 0) or if 4 in-plane IPs fail (PFL < 0). (MAT_054 only, thin shells only).
EPSF	Damage initiation transverse shear strain. (MAT_054 only, thin shells only).
EPSR	Final rupture transverse shear strain. (MAT_054 only, thin shells only).
TSMD	Transverse shear maximum damage, default = 0.90. (MAT_054 only, thin shells only).
SOFT2	Optional “orthogonal” softening reduction factor for material strength in crashfront elements (default = 1.0). See remarks (thin shells only).
SLIMT1	Factor to determine the minimum stress limit after stress maximum (fiber tension). Similar to *MAT_058 (thin shells only).
SLIMC1	Factor to determine the minimum stress limit after stress maximum (fiber compression). Similar to *MAT_058 (thin shells only).
SLIMT2	Factor to determine the minimum stress limit after stress maximum (matrix tension). Similar to *MAT_058 (thin shells only).
SLIMC2	Factor to determine the minimum stress limit after stress maximum (matrix compression). Similar to *MAT_058 (thin shells only).
SLIMS	Factor to determine the minimum stress limit after stress maximum (shear). Similar to *MAT_058 (thin shells only).
NCYRED	Number of cycles for stress reduction from maximum to minimum (thin shells only).

VARIABLE	DESCRIPTION
SOFTG	Softening reduction factor for transverse shear moduli GBC and GCA in crashfront elements (default = 1.0) (thin shells only).
LCXC	Load curve ID for XC vs. strain rate (XC is ignored with that option)
LCXT	Load curve ID for XT vs. strain rate (XT is ignored with that option)
LCYC	Load curve ID for YC vs. strain rate (YC is ignored with that option)
LCYT	Load curve ID for YT vs. strain rate (YT is ignored with that option)
LCSC	Load curve ID for SC vs. strain rate (SC is ignored with that option)
DT	Strain rate averaging option. EQ.0.0: Strain rate is evaluated using a running average. LT.0.0: Strain rate is evaluated using average of last 11 time steps. GT.0.0: Strain rate is averaged over the last DT time units.

Remarks:

The Chang/Chang (MAT_54) criteria is given as follows:

for the tensile fiber mode,

$$\sigma_{aa} > 0 \Rightarrow e_f^2 = \left(\frac{\sigma_{aa}}{X_t}\right)^2 + \beta \left(\frac{\sigma_{ab}}{S_c}\right) - 1 \quad \begin{cases} \geq 0 & \text{failed} \\ < 0 & \text{elastic} \end{cases}$$

$$E_a = E_b = G_{ab} = \nu_{ba} = \nu_{ab} = 0$$

for the compressive fiber mode,

$$\sigma_{aa} < 0 \Rightarrow e_c^2 = \left(\frac{\sigma_{aa}}{X_c}\right)^2 - 1 \quad \begin{cases} \geq 0 & \text{failed} \\ < 0 & \text{elastic} \end{cases}$$

$$E_a = \nu_{ba} = \nu_{ab} = 0$$

for the tensile matrix mode,

$$\sigma_{bb} > 0 \Rightarrow e_m^2 = \left(\frac{\sigma_{bb}}{Y_t}\right)^2 + \left(\frac{\sigma_{ab}}{S_c}\right)^2 - 1 \quad \begin{cases} \geq 0 & \text{failed} \\ < 0 & \text{elastic} \end{cases}$$

$$E_b = \nu_{ba} = 0 \Rightarrow G_{ab} = 0,$$

and for the compressive matrix mode,

$$\sigma_{bb} < 0 \Rightarrow e_d^2 = \left(\frac{\sigma_{bb}}{2S_c}\right)^2 + \left[\left(\frac{Y_c}{2S_c}\right)^2 - 1\right] \frac{\sigma_{bb}}{Y_c} + \left(\frac{\sigma_{ab}}{S_c}\right)^2 - 1 \quad \begin{cases} \geq 0 & \text{failed} \\ < 0 & \text{elastic} \end{cases}$$

$$E_b = \nu_{ba} = \nu_{ab} = 0 \Rightarrow G_{ab} = 0$$

$$X_c = 2Y_c, \text{ for 50\% fiber volume}$$

In the Tsai-Wu (MAT_055) criteria the tensile and compressive fiber modes are treated as in the Chang-Chang criteria. The failure criterion for the tensile and compressive matrix mode is given as:

$$e_{md}^2 = \frac{\sigma_{bb}^2}{Y_c Y_t} + \left(\frac{\sigma_{ab}}{S_c}\right)^2 + \frac{(Y_c - Y_t) \sigma_{bb}}{Y_c Y_t} - 1 \quad \begin{cases} \geq 0 & \text{failed} \\ < 0 & \text{elastic} \end{cases}$$

For $\beta = 1$ we get the original criterion of Hashin [1980] in the tensile fiber mode. For $\beta = 0$ we get the maximum stress criterion which is found to compare better to experiments.

In MAT_054, failure can occur in any of four different ways:

1. If DFAILT is zero, failure occurs if the Chang-Chang failure criterion is satisfied in the tensile fiber mode.
2. If DFAILT is greater than zero, failure occurs if the tensile fiber strain is greater than DFAILT or less than DFAILC.
3. If EFS is greater than zero, failure occurs if the effective strain is greater than EFS.
4. If TFAIL is greater than zero, failure occurs according to the element timestep as described in the definition of TFAIL above.

When failure has occurred in all the composite layers (through-thickness integration points), the element is deleted. Elements which share nodes with the deleted element become "crashfront" elements and can have their strengths reduced by using the SOFT parameter with TFAIL greater than zero. An earlier initiation of crashfront elements is possible by using parameter PFL.

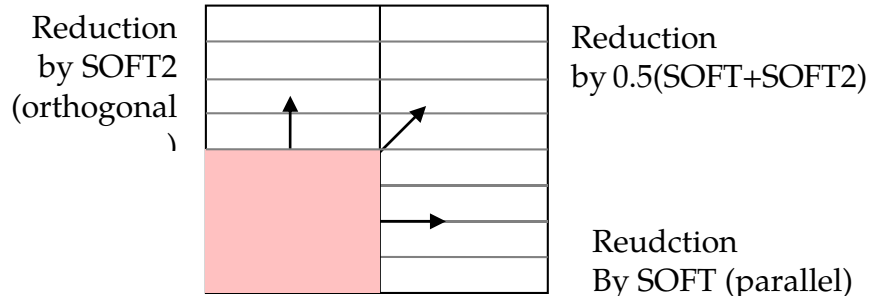

Figure 2-29. Direction dependent softening

An optional direction dependent strength reduction can be invoked by setting $0 < SOFT2 < 1$. Then, $SOFT$ equals a strength reduction factor for fiber parallel failure and $SOFT2$ equals a strength reduction factor for fiber orthogonal failure. Linear interpolation is used for angles in between. See [Figure 2-29](#).

Information about the status in each layer (integration point) and element can be plotted using additional integration point variables. The number of additional integration point variables for shells written to the LS-DYNA database is input by the `*DATABASE_EXTENT_BINARY` definition as variable `NEIPS`. For Models 54 and 55 these additional variables are tabulated below (i = shell integration point):

History Variable	Description	Value	LS-PrePost history variable
1 $f(i)$	tensile fiber mode	1 - elastic	1
2 $ec(i)$	compressive fiber mode		2
3 $em(i)$	tensile matrix mode		3
4 $ed(i)$	compressive matrix mode	0 - failed	4
5 $efail$	$\max[ef(ip)]$		5
6 dam	damage parameter	-1 - element intact 10^{-8} - element in crashfront +1 - element failed	6

These variables can be plotted in LS-PrePost element history variables 1 to 6. The following components, defined by the sum of failure indicators over all through-thickness integration points, are stored as element component 7 instead of the effective plastic strain.

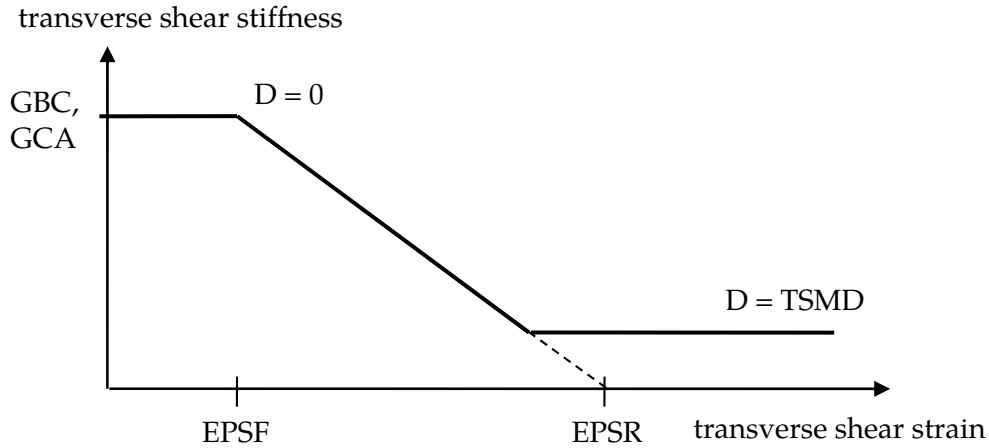

Figure 2-30. Linear Damage for transverse shear behavior

Description	Integration point
$\frac{1}{nip} \sum_{i=1}^{nip} ef(i)$	1
$\frac{1}{nip} \sum_{i=1}^{nip} ec(i)$	2
$\frac{1}{nip} \sum_{i=1}^{nip} em(i)$	3

In an optional damage model for transverse shear strain, out-of-plane stiffness (GBC and GCA) can get linearly decreased to model interlaminar shear failure. Damage starts when effective transverse shear strain

$$\epsilon_{56}^{eff} = \sqrt{\epsilon_{yz}^2 + \epsilon_{zx}^2}$$

reaches EPSF. Final rupture occurs when effective transverse shear strain reaches EPSR. A maximum damage of TSMD (0.0 < TSMD < 0.99) cannot be exceeded. See [Figure 2-30](#).

***MAT_LOW_DENSITY_FOAM**

This is Material Type 57 for modeling highly compressible low density foams. Its main applications are for seat cushions and padding on the Side Impact Dummies (SID). Optionally, a tension cut-off failure can be defined. A table can be defined if thermal effects are considered in the nominal stress versus strain behavior. Also, see the notes below.

Card 1	1	2	3	4	5	6	7	8
Variable	MID	RO	E	LCID	TC	HU	BETA	DAMP
Type	A8	F	F	F	F	F	F	F
Default					1.E+20	1.		0.05
Remarks						3	1	

Card 2	1	2	3	4	5	6	7	8
Variable	SHAPE	FAIL	BVFLAG	ED	BETA1	KCON	REF	
Type	F	F	F	F	F	F	F	
Default	1.0	0.0	0.0	0.0	0.0	0.0	0.0	
Remarks	3		2	5	5	6		

VARIABLE**DESCRIPTION**

MID	Material identification. A unique number or label not exceeding 8 characters must be specified.
RO	Mass density
E	Young's modulus used in tension. For implicit problems E is set to the initial slope of load curve LCID.

VARIABLE	DESCRIPTION
LCID	Load curve or table ID, see *DEFINE_CURVE, for the nominal stress versus strain curve definition. If a table is used, a family of curves is defined each corresponding to a discrete temperature, see *DEFINE_TABLE.
TC	Cut-off for the nominal tensile stress τ_i
HU	Hysteretic unloading factor between 0 and 1 (default = 1, i.e., no energy dissipation), see also Figure 2-31 .
BETA	β , decay constant to model creep in unloading
DAMP	Viscous coefficient (.05 < recommended value < .50) to model damping effects. <p>LT.0.0: DAMP is the load curve ID, which defines the damping constant as a function of the maximum strain in compression defined as:</p> $\varepsilon_{\max} = \max(1 - \lambda_1, 1 - \lambda_2, 1 - \lambda_3).$ <p>In tension, the damping constant is set to the value corresponding to the strain at 0. The abscissa should be defined from 0 to 1.</p>
SHAPE	Shape factor for unloading. Active for nonzero values of the hysteretic unloading factor. Values less than one reduces the energy dissipation and greater than one increases dissipation, see also Figure 2-31 .
FAIL	Failure option after cutoff stress is reached: <p>EQ.0.0: tensile stress remains at cut-off value, EQ.1.0: tensile stress is reset to zero.</p>
BVFLAG	Bulk viscosity activation flag, see remark below: <p>EQ.0.0: no bulk viscosity (recommended), EQ.1.0: bulk viscosity active.</p>
ED	Optional Young's relaxation modulus, E_d , for rate effects. See comments below.
BETA1	Optional decay constant, β_1 .

VARIABLE	DESCRIPTION
KCON	Stiffness coefficient for contact interface stiffness. If undefined the maximum slope in stress vs. strain curve is used. When the maximum slope is taken for the contact, the time step size for this material is reduced for stability. In some cases Δt may be significantly smaller, and defining a reasonable stiffness is recommended.
REF	Use reference geometry to initialize the stress tensor. The reference geometry is defined by the keyword:*INITIAL_FOAM_REFERENCE_GEOMETRY (see there for more details). EQ.0.0: off, EQ.1.0: on.

Material Formulation:

The compressive behavior is illustrated in [Figure 2-31](#) where hysteresis on unloading is shown. This behavior under uniaxial loading is assumed not to significantly couple in the transverse directions. In tension the material behaves in a linear fashion until tearing occurs. Although our implementation may be somewhat unusual, it was motivated by Storakers [1986].

The model uses tabulated input data for the loading curve where the nominal stresses are defined as a function of the elongations, ε_i , which are defined in terms of the principal stretches, λ_i , as:

$$\varepsilon_i = \lambda_i - 1$$

The stretch ratios are found by solving for the eigenvalues of the left stretch tensor, V_{ij} , which is obtained via a polar decomposition of the deformation gradient matrix, F_{ij} . Recall that,

$$F_{ij} = R_{ik}U_{kj} = V_{ik}R_{kj}$$

The update of V_{ij} follows the numerically stable approach of Taylor and Flanagan [1989]. After solving for the principal stretches, we compute the elongations and, if the elongations are compressive, the corresponding values of the nominal stresses, τ_i are interpolated. If the elongations are tensile, the nominal stresses are given by

$$\tau_i = E\varepsilon_i$$

and the Cauchy stresses in the principal system become

$$\sigma_i = \frac{\tau_i}{\lambda_j\lambda_k}$$

The stresses can now be transformed back into the global system for the nodal force calculations.

Remarks:

1. When hysteretic unloading is used the reloading will follow the unloading curve if the decay constant, β , is set to zero. If β is nonzero the decay to the original loading curve is governed by the expression:

$$1 - e^{-\beta t}$$

2. The bulk viscosity, which generates a rate dependent pressure, may cause an unexpected volumetric response and, consequently, it is optional with this model.
3. The hysteretic unloading factor results in the unloading curve to lie beneath the loading curve as shown in [Figure 2-31](#) This unloading provides energy dissipation which is reasonable in certain kinds of foam.

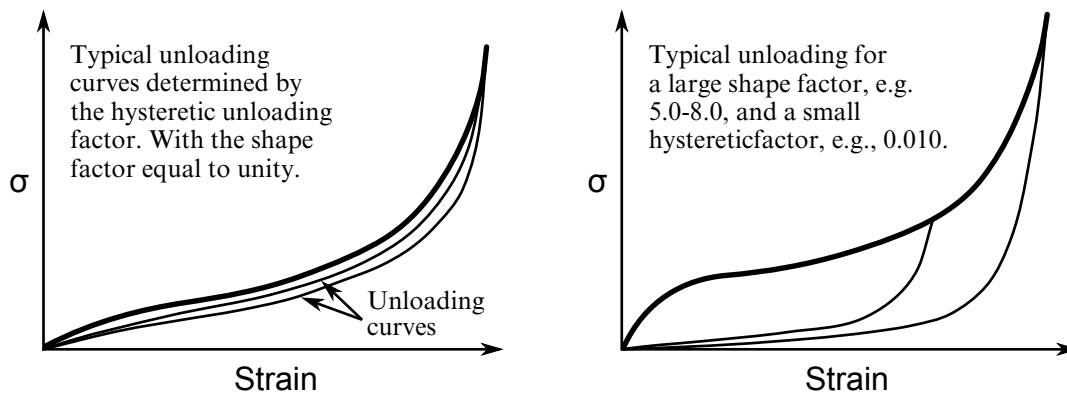

Figure 2-31. Behavior of the low density urethane foam model

4. Note that since this material has no effective plastic strain, the internal energy per initial volume is written into the output databases.
5. Rate effects are accounted for through linear viscoelasticity by a convolution integral of the form

$$\sigma_{ij}^r = \int_0^t g_{ijkl}(t - \tau) \frac{\partial \varepsilon_{kl}}{\partial \tau} d\tau$$

where $g_{ijkl}(t - \tau)$ is the relaxation function. The stress tensor, σ_{ij}^r , augments the stresses determined from the foam, σ_{ij}^f ; consequently, the final stress, σ_{ij} , is taken as the summation of the two contributions:

$$\sigma_{ij} = \sigma_{ij}^f + \sigma_{ij}^r.$$

Since we wish to include only simple rate effects, the relaxation function is represented by one term from the Prony series:

$$g(t) = \alpha_0 + \sum_{m=1}^N \alpha_m e^{-\beta t}$$

given by,

$$g(t) = E_d e^{-\beta_1 t}$$

This model is effectively a Maxwell fluid which consists of a damper and spring in series. We characterize this in the input by a Young's modulus, E_d , and decay constant, β_1 . The formulation is performed in the local system of principal stretches where only the principal values of stress are computed and triaxial coupling is avoided. Consequently, the one-dimensional nature of this foam material is unaffected by this addition of rate effects. The addition of rate effects necessitates twelve additional history variables per integration point. The cost and memory overhead of this model comes primarily from the need to "remember" the local system of principal stretches.

6. The time step size is based on the current density and the maximum of the instantaneous loading slope, E , and $KCON$. If $KCON$ is undefined the maximum slope in the loading curve is used instead.

***MAT_LAMINATED_COMPOSITE_FABRIC**

This is Material Type 58. Depending on the type of failure surface, this model may be used to model composite materials with unidirectional layers, complete laminates, and woven fabrics. This model is implemented for shell and thick shell elements.

Card 1	1	2	3	4	5	6	7	8
Variable	MID	RO	EA	EB	(EC)	PRBA	TAU1	GAMMA1
Type	A8	F	F	F	F	F	F	F

Card 2	1	2	3	4	5	6	7	8
Variable	GAB	GBC	GCA	SLIMT1	SLIMC1	SLIMT2	SLIMC2	SLIMS
Type	F	F	F	F	F	F	F	F

Card 3	1	2	3	4	5	6	7	8
Variable	AOPT	TSIZE	ERODS	SOFT	FS	EPSF	EPSR	TSMD
Type	F	F	F	F	F	F	F	F

Card 4	1	2	3	4	5	6	7	8
Variable	XP	YP	ZP	A1	A2	A3		
Type	F	F	F	F	F	F		

Card 5	1	2	3	4	5	6	7	8
Variable	V1	V2	V3	D1	D2	D3	BETA	
Type	F	F	F	F	F	F	F	

Card 6	1	2	3	4	5	6	7	8
Variable	E11C	E11T	E22C	E22T	GMS			
Type	F	F	F	F	F			

Card 7	1	2	3	4	5	6	7	8
Variable	XC	XT	YC	YT	SC			
Type	F	F	F	F	F			

First Optional Strain Rate Dependence Card.

Card 8	1	2	3	4	5	6	7	8
Variable	LCXC	LCXT	LCYC	LCYT	LCSC	LCTAU	LCGAM	DT
Type	I	I	I	I	I	I	I	F

Second Optional Strain Rate Dependence Card.

Card 9	1	2	3	4	5	6	7	8
Variable	LCE11C	LCE11T	LCE22C	LCE22T	LCGMS			
Type	I	I	I	I	I			

VARIABLE

DESCRIPTION

- MID Material identification. A unique number or label not exceeding 8 characters must be specified.
- RO Mass density
- EA E_a , Young's modulus - longitudinal direction
- EB E_b , Young's modulus - transverse direction
- (EC) E_c , Young's modulus - normal direction (not used)

VARIABLE	DESCRIPTION
PRBA	ν_{ba} , Poisson's ratio ba
TAU1	τ_1 , stress limit of the first slightly nonlinear part of the shear stress versus shear strain curve. The values τ_1 and γ_1 are used to define a curve of shear stress versus shear strain. These values are input if FS, defined below, is set to a value of -1.
GAMMA1	γ_1 , strain limit of the first slightly nonlinear part of the shear stress versus engineering shear strain curve.
GAB	G_{ab} , shear modulus ab
GBC	G_{bc} , shear modulus bc
GCA	G_{ca} , shear modulus ca
SLIMT1	Factor to determine the minimum stress limit after stress maximum (fiber tension).
SLIMC1	Factor to determine the minimum stress limit after stress maximum (fiber compression).
SLIMT2	Factor to determine the minimum stress limit after stress maximum (matrix tension).
SLIMC2	Factor to determine the minimum stress limit after stress maximum (matrix compression).
SLIMS	Factor to determine the minimum stress limit after stress maximum (shear).
AOPT	Material axes option (see MAT_OPTION TROPIC_ELASTIC for a more complete description): <ul style="list-style-type: none"> EQ.0.0: locally orthotropic with material axes determined by element nodes 1, 2, and 4, as with *DEFINE_COORDINATE_NODES, and then rotated about the shell element normal by an angle BETA. EQ.2.0: globally orthotropic with material axes determined by vectors defined below, as with *DEFINE_COORDINATE_VECTOR. EQ.3.0: locally orthotropic material axes determined by rotating the material axes about the element normal by an angle (BETA) from a line in the plane of the element defined by

VARIABLE	DESCRIPTION
	the cross product of the vector v with the element normal.
	LT.0.0: the absolute value of AOPT is a coordinate system ID number (CID on *DEFINE_COORDINATE_NODES, *DEFINE_COORDINATE_SYSTEM or *DEFINE_COORDINATE_VECTOR). Available in R3 version of 971 and later.
TSIZE	Time step for automatic element deletion.
ERODS	Maximum effective strain for element layer failure. A value of unity would equal 100% strain. GT.0.0: fails when effective strain calculated assuming material is volume preserving exceeds ERODS (old way). LT.0.0: fails when effective strain calculated from the full strain tensor exceeds ERODS .
SOFT	Softening reduction factor for strength in the crashfront.
FS	Failure surface type: EQ.1.0: smooth failure surface with a quadratic criterion for both the fiber (a) and transverse (b) directions. This option can be used with complete laminates and fabrics. EQ.0.0: smooth failure surface in the transverse (b) direction with a limiting value in the fiber (a) direction. This model is appropriate for unidirectional (UD) layered composites only. EQ.-1.: faceted failure surface. When the strength values are reached then damage evolves in tension and compression for both the fiber and transverse direction. Shear behavior is also considered. This option can be used with complete laminates and fabrics.
EPSF	Damage initiation transverse shear strain.
EPSF	Final rupture transverse shear strain.
TSMD	Transverse shear maximum damage, default = 0.90.
XP, YP, ZP	Define coordinates of point p for AOPT = 1.

VARIABLE	DESCRIPTION
A1, A2, A3	Define components of vector a for AOPT = 2.
V1, V2 V3	Define components of vector v for AOPT = 3.
D1, D2, D3	Define components of vector d for AOPT = 2.
BETA	Material angle in degrees for AOPT = 0 and 3, may be overridden on the element card, see *ELEMENT_SHELL_BETA.
E11C	Strain at longitudinal compressive strength, a-axis (positive).
E11T	Strain at longitudinal tensile strength, a-axis.
E22C	Strain at transverse compressive strength, b-axis.
E22T	Strain at transverse tensile strength, b-axis.
GMS	Engineering shear strain at shear strength, ab plane.
XC	Longitudinal compressive strength (positive value).
XT	Longitudinal tensile strength, see below.
YC	Transverse compressive strength, b-axis (positive value), see below.
YT	Transverse tensile strength, b-axis, see below.
SC	Shear strength, ab plane, see below.
LCXC	Load curve ID defining longitudinal compressive strength XC vs. strain rate (XC is ignored with that option). If the first strain rate value in the curve is negative, it is assumed that all strain rate values are given as natural logarithm of the strain rate.
LCXT	Load curve ID defining longitudinal tensile strength XT vs. strain rate (XT is ignored with that option) If the first strain rate value in the curve is negative, it is assumed that all strain rate values are given as natural logarithm of the strain rate.
LCYC	Load curve ID defining transverse compressive strength YC vs. strain rate (YC is ignored with that option) If the first strain rate value in the curve is negative, it is assumed that all strain rate values are given as natural logarithm of the strain rate.

VARIABLE	DESCRIPTION
LCYT	Load curve ID defining transverse tensile strength YT vs. strain rate (YT is ignored with that option) If the first strain rate value in the curve is negative, it is assumed that all strain rate values are given as natural logarithm of the strain rate.
LCSC	Load curve ID defining shear strength SC vs. strain rate (SC is ignored with that option) If the first strain rate value in the curve is negative, it is assumed that all strain rate values are given as natural logarithm of the strain rate.
LCTAU	Load curve ID defining TAU1 vs. strain rate (TAU1 is ignored with that option). This value is only used for FS = -1. If the first strain rate value in the curve is negative, it is assumed that all strain rate values are given as natural logarithm of the strain rate.
LCGAM	Load curve ID defining GAMMA1 vs. strain rate (GAMMA1 is ignored with that option). This value is only used for FS = -1. If the first strain rate value in the curve is negative, it is assumed that all strain rate values are given as natural logarithm of the strain rate.
DT	Strain rate averaging option. EQ.0.0: Strain rate is evaluated using a running average. LT.0.0: Strain rate is evaluated using average of last 11 time steps. GT.0.0: Strain rate is averaged over the last DT time units.
LCE11C	Load curve ID defining E11C vs. strain rate (E11C is ignored with that option) If the first strain rate value in the curve is negative, it is assumed that all strain rate values are given as natural logarithm of the strain rate.
LCE11T	Load curve ID defining E11T vs. strain rate (E11T is ignored with that option) If the first strain rate value in the curve is negative, it is assumed that all strain rate values are given as natural logarithm of the strain rate.
LCE22C	Load curve ID defining E22C vs. strain rate (E22C is ignored with that option) If the first strain rate value in the curve is negative, it is assumed that all strain rate values are given as natural logarithm of the strain rate.

VARIABLE	DESCRIPTION
LCE22T	Load curve ID defining E22T vs. strain rate (E22T is ignored with that option) If the first strain rate value in the curve is negative, it is assumed that all strain rate values are given as natural logarithm of the strain rate.
LCGMS	Load curve ID defining GMS vs. strain rate (GMS is ignored with that option) If the first strain rate value in the curve is negative, it is assumed that all strain rate values are given as natural logarithm of the strain rate.

Remarks:

Parameters to control failure of an element layer are: ERODS, the maximum effective strain, i.e., maximum 1 = 100% straining. The layer in the element is completely removed after the maximum effective strain (compression/tension including shear) is reached.

The stress limits are factors used to limit the stress in the softening part to a given value,

$$\sigma_{\min} = \text{SLIMxx} \times \text{strength},$$

thus, the damage value is slightly modified such that elastoplastic like behavior is achieved with the threshold stress. As a factor for SLIMxx a number between 0.0 and 1.0 is possible. With a factor of 1.0, the stress remains at a maximum value identical to the strength, which is similar to ideal elastoplastic behavior. For tensile failure a small value for SLIMTx is often reasonable; however, for compression SLIMCx = 1.0 is preferred. This is also valid for the corresponding shear value. If SLIMxx is smaller than 1.0 then localization can be observed depending on the total behavior of the lay-up. If the user is intentionally using SLIMxx < 1.0, it is generally recommended to avoid a drop to zero and set the value to something in between 0.05 and 0.10. Then elastoplastic behavior is achieved in the limit which often leads to less numerical problems. Defaults for SLIMXX = 1.0E-8.

The crashfront-algorithm is started if and only if a value for TSIZE (time step size, with element elimination after the actual time step becomes smaller than TSIZE) is input.

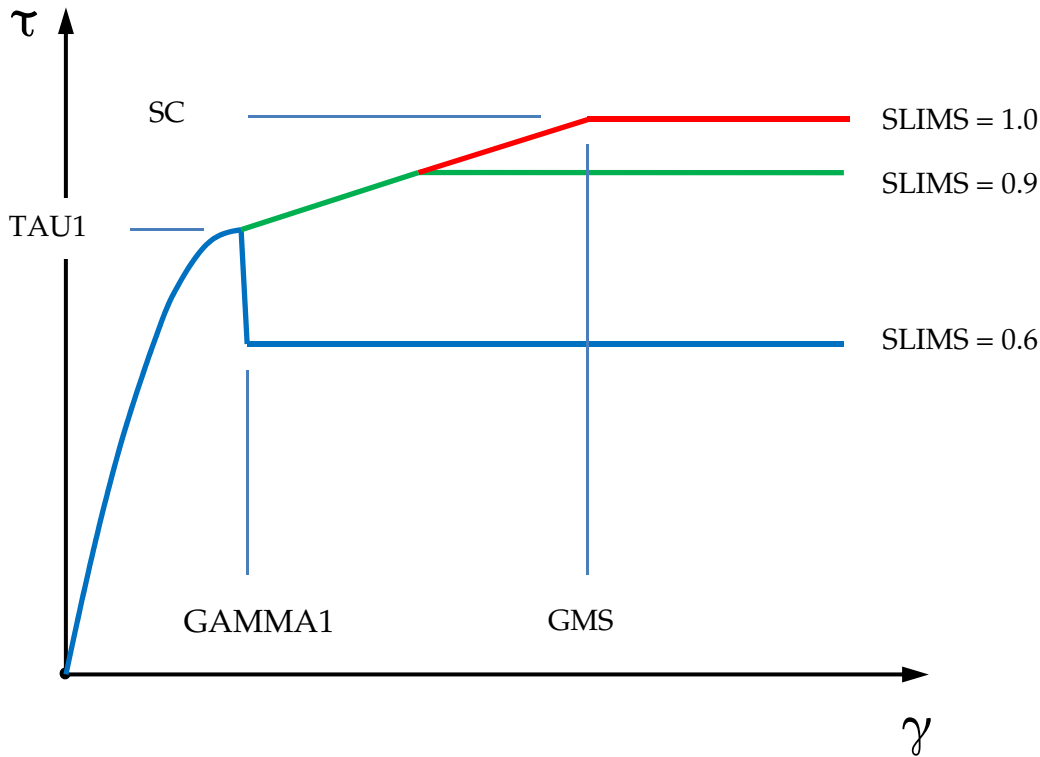

Figure 2-32. Stress-strain diagram for shear

The damage parameters can be written to the postprocessing database for each integration point as the first three additional element variables and can be visualized.

Material models with FS = 1 or FS = -1 are favorable for complete laminates and fabrics, as all directions are treated in a similar fashion.

For material model FS = 1 an interaction between normal stresses and the shear stresses is assumed for the evolution of damage in the a and b-directions. For the shear damage is always the maximum value of the damage from the criterion in a or b-direction is taken.

For material model FS = -1 it is assumed that the damage evolution is independent of any of the other stresses. A coupling is only present via the elastic material parameters and the complete structure.

In tensile and compression directions and in a as well as in b- direction different failure surfaces can be assumed. The damage values, however, increase only also when the loading direction changes.

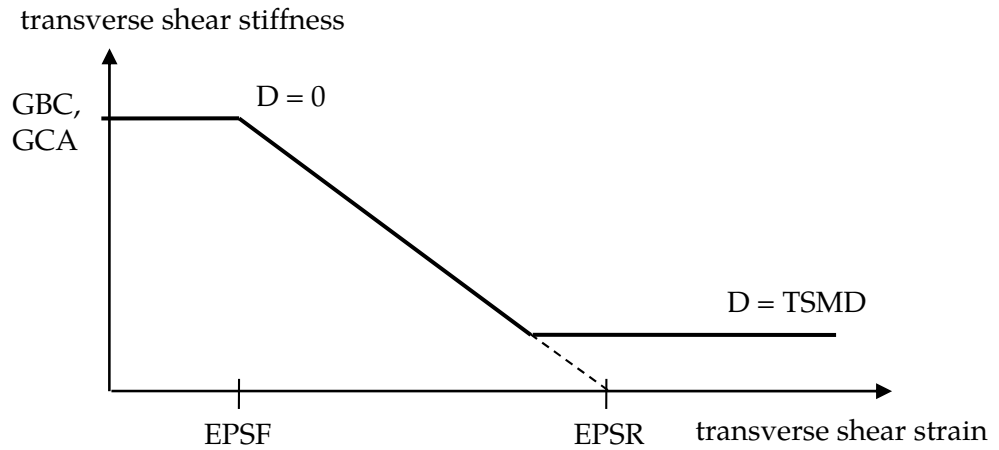

Figure 2-33. Linear Damage for transverse shear behavior

Special control of shear behavior of fabrics:

For fabric materials a nonlinear stress strain curve for the shear part for failure surface $FS = -1$ can be assumed as given below. This is not possible for other values of FS .

The curve, shown in [Figure 2-32](#) is defined by three points:

1. the origin (0,0) is assumed,
2. the limit of the first slightly nonlinear part (must be input), stress (TAU1) and strain (GAMMA1), see below.
3. the shear strength at failure and shear strain at failure.

In addition a stress limiter can be used to keep the stress constant via the *SLIMS* parameter. This value must be less or equal 1.0 but positive, and leads to an elastoplastic behavior for the shear part. The default is 1.0E-08, assuming almost brittle failure once the strength limit *SC* is reached.

*MAT_059

*MAT_COMPOSITE_FAILURE_{OPTION}_MODEL

*MAT_COMPOSITE_FAILURE_{OPTION}_MODEL

This is Material Type 59.

Available options include:

SHELL

SOLID

SPH

depending on the element type the material is to be used with, see *PART.

Card 1	1	2	3	4	5	6	7	8
Variable	MID	RO	EA	EB	EC	PRBA	PRCA	PRCB
Type	A8	F	F	F	F	F	F	F

Card 2	1	2	3	4	5	6	7	8
Variable	GAB	GBC	GCA	KF	AOPT	MACF		
Type	F	F	F	F	F	I		

Card 3	1	2	3	4	5	6	7	8
Variable	XP	YP	ZP	A1	A2	A3		
Type	F	F	F	F	F	F		

Card 4	1	2	3	4	5	6	7	8
Variable	V1	V2	V3	D1	D2	D3	BETA	
Type	F	F	F	F	F	F	F	

Card 5 for SHELL Keyword Option.

Card 5	1	2	3	4	5	6	7	8
Variable	TSIZE	ALP	SOFT	FBRT	SR	SF		
Type	F	F	F	F	F	F		

Card 6 for SHELL Keyword Option.

Card 6	1	2	3	4	5	6	7	8
Variable	XC	XT	YC	YT	SC			
Type	F	F	F	F	F			

Card 5 for SPH and SOLID Keyword Options.

Card 5	1	2	3	4	5	6	7	8
Variable	SBA	SCA	SCB	XXC	YYC	ZZC		
Type	F	F	F	F	F	F		

Card 6 for SPH and SOLID Keyword Options.

Card 6	1	2	3	4	5	6	7	8
Variable	XXT	YYT	ZZT					
Type	F	F	F					

VARIABLE

DESCRIPTION

MID	Material identification. A unique number or label not exceeding 8 characters must be specified.
RO	Density
EA	E_a , Young's modulus - longitudinal direction

VARIABLE	DESCRIPTION
EB	E_b , Young's modulus - transverse direction
EC	E_c , Young's modulus - normal direction
PRBA	ν_{ba} Poisson's ratio ba
PRCA	ν_{ca} Poisson's ratio ca
PRCB	ν_{cb} Poisson's ratio cb
GAB	G_{ab} Shear Modulus
GBC	G_{bc} Shear Modulus
GCA	G_{ca} Shear Modulus
KF	Bulk modulus of failed material
AOPT	<p>Material axes option (see <code>MAT_OPTIONTROPIC_ELASTIC</code> for a more complete description) (SPH particles only support <code>AOPT = 2.0</code>):</p> <p>EQ.0.0: locally orthotropic with material axes determined by element nodes 1, 2, and 4, as with <code>*DEFINE_COORDINATE_NODES</code>, and then, for shells only, rotated about the shell element normal by an angle <code>BETA</code>.</p> <p>EQ.1.0: locally orthotropic with material axes determined by a point in space and the global location of the element center; this is the a-direction. This option is for solid elements only.</p> <p>EQ.2.0: globally orthotropic with material axes determined by vectors defined below, as with <code>*DEFINE_COORDINATE_VECTOR</code>.</p> <p>EQ.3.0: locally orthotropic material axes determined by rotating the material axes about the element normal by an angle, <code>BETA</code>, from a line in the plane of the element defined by the cross product of the vector <code>v</code> with the element normal.</p> <p>EQ.4.0: locally orthotropic in cylindrical coordinate system with the material axes determined by a vector <code>v</code>, and an originating point, <code>P</code>, which define the centerline axis. This option is for solid elements only.</p> <p>LT.0.0: the absolute value of <code>AOPT</code> is a coordinate system ID</p>

VARIABLE	DESCRIPTION
	number (CID on *DEFINE_COORDINATE_NODES, *DEFINE_COORDINATE_SYSTEM or *DEFINE_COORDINATE_VECTOR). Available in R3 version of 971 and later.
MACF	Material axes change flag for brick elements. EQ.1: No change, default, EQ.2: switch material axes a and b, EQ.3: switch material axes a and c, EQ.4: switch material axes b and c.
XP YP ZP	Define coordinates of point p for AOPT = 1 and 4.
A1 A2 A3	Define components of vector a for AOPT = 2.
V1 V2 V3	Define components of vector v for AOPT = 3 and 4.
D1 D2 D3	Define components of vector d for AOPT = 2:
BETA	Material angle in degrees for AOPT = 0 (shells only) and AOPT = 3, may be overridden on the element card, see *ELEMENT_SHELL_BETA or *ELEMENT_SOLID_ORTHO.
TSIZE	Time step for automatic element deletion
ALP	Nonlinear shear stress parameter
SOFT	Softening reduction factor for strength in crush
FBRT	Softening of fiber tensile strength
SR	s_r , reduction factor (default = 0.447)
SF	s_f , softening factor (default = 0.0)
XC	Longitudinal compressive strength, a-axis (positive value).
XT	Longitudinal tensile strength, a-axis
YC	Transverse compressive strength, b-axis (positive value).
YT	Transverse tensile strength, b-axis

VARIABLE	DESCRIPTION
SC	Shear strength, ab plane: GT.0.0: faceted failure surface theory, LT.0.0: ellipsoidal failure surface theory.
SBA	In plane shear strength.
SCA	Transverse shear strength.
SCB	Transverse shear strength.
XXC	Longitudinal compressive strength a-axis (positive value).
YYC	Transverse compressive strength b-axis (positive value).
ZZC	Normal compressive strength c-axis (positive value).
XXT	Longitudinal tensile strength a-axis.
YYT	Transverse tensile strength b-axis.
ZZT	Normal tensile strength c-axis.

***MAT_ELASTIC_WITH_VISCOSITY**

This is Material Type 60 which was developed to simulate forming of glass products (e.g., car windshields) at high temperatures. Deformation is by viscous flow but elastic deformations can also be large. The material model, in which the viscosity may vary with temperature, is suitable for treating a wide range of viscous flow problems and is implemented for brick and shell elements.

Card 1	1	2	3	4	5	6	7	8
Variable	MID	R0	V0	A	B	C	LCID	
Type	A8	F	F	F	F	F	F	

Card 2	1	2	3	4	5	6	7	8
Variable	PR1	PR2	PR3	PR4	PR5	PR6	PR7	PR8
Type	F	F	F	F	F	F	F	F

Card 3	1	2	3	4	5	6	7	8
Variable	T1	T2	T3	T4	T5	T6	T7	T8
Type	F	F	F	F	F	F	F	F

Card 4	1	2	3	4	5	6	7	8
Variable	V1	V2	V3	V4	V5	V6	V7	V8
Type	F	F	F	F	F	F	F	F

Card 5	1	2	3	4	5	6	7	8
Variable	E1	E2	E3	E4	E5	E6	E7	E8
Type	F	F	F	F	F	F	F	F

Card 6	1	2	3	4	5	6	7	8
Variable	ALPHA1	ALPHA2	ALPHA3	ALPHA4	ALPHA5	ALPHA6	ALPHA7	ALPHA8
Type	F	F	F	F	F	F	F	F

VARIABLE**DESCRIPTION**

MID	Material identification. A unique number or label not exceeding 8 characters must be specified.
RO	Mass density
V0	Temperature independent dynamic viscosity coefficient, V_0 . If defined, the temperature dependent viscosity defined below is skipped, see type (i) and (ii) definitions for viscosity below.
A	Dynamic viscosity coefficient, see type (i) and (ii) definitions below.
B	Dynamic viscosity coefficient, see type (i) and (ii) definitions below.
C	Dynamic viscosity coefficient, see type (i) and (ii) definitions below.
LCID	Load curve (see *DEFINE_CURVE) defining viscosity versus temperature, see type (iii). (Optional)
T1, T2, ..., TN	Temperatures, define up to 8 values
PR1, PR2, ..., PRN	Poisson's ratios for the temperatures T_i
V1, V2, ..., VN	Corresponding dynamic viscosity coefficients (define only one if not varying with temperature)
E1, E2, ..., EN	Corresponding Young's moduli coefficients (define only one if not varying with temperature)

VARIABLE	DESCRIPTION
ALPHA1, ..., ALPHAN.	Corresponding thermal expansion coefficients

Remarks:

Volumetric behavior is treated as linear elastic. The deviatoric strain rate is considered to be the sum of elastic and viscous strain rates:

$$\dot{\boldsymbol{\epsilon}}'_{\text{total}} = \dot{\boldsymbol{\epsilon}}'_{\text{elastic}} + \dot{\boldsymbol{\epsilon}}'_{\text{viscous}} = \frac{\boldsymbol{\sigma}'}{2G} + \frac{\boldsymbol{\sigma}'}{2\nu}$$

where G is the elastic shear modulus, ν is the viscosity coefficient, and bold indicates a tensor. The stress increment over one timestep dt is

$$d\boldsymbol{\sigma}' = 2G\dot{\boldsymbol{\epsilon}}'_{\text{total}}dt - \frac{G}{\nu}dt\boldsymbol{\sigma}'$$

The stress before the update is used for $\boldsymbol{\sigma}'$. For shell elements the through-thickness strain rate is calculated as follows.

$$d\sigma_{33} = 0 = K(\dot{\epsilon}_{11} + \dot{\epsilon}_{22} + \dot{\epsilon}_{33})dt + 2G\dot{\epsilon}'_{33}dt - \frac{G}{\nu}dt\sigma'_{33}$$

where the subscript $ij = 33$ denotes the through-thickness direction and K is the elastic bulk modulus. This leads to:

$$\dot{\epsilon}_{33} = -a(\dot{\epsilon}_{11} + \dot{\epsilon}_{22}) + bp$$

$$a = \frac{\left(K - \frac{2}{3}G\right)}{\left(K + \frac{4}{3}G\right)}$$

$$b = \frac{Gdt}{\nu\left(K + \frac{4}{3}G\right)}$$

in which p is the pressure defined as the negative of the hydrostatic stress.

The variation of viscosity with temperature can be defined in any one of the 3 ways.

- (i) Constant, $V = V_0$ Do not define constants, A , B , and C or the piecewise curve.(leave card 4 blank)
- (ii) $V = V_0 \times 10^{(A/(T-B) + C)}$
- (iii) Piecewise curve: define the variation of viscosity with temperature.

NOTE: Viscosity is inactive during dynamic relaxation.

***MAT_ELASTIC_WITH_VISCOSITY_CURVE**

This is Material Type 60 which was developed to simulate forming of glass products (e.g., car windshields) at high temperatures. Deformation is by viscous flow but elastic deformations can also be large. The material model, in which the viscosity may vary with temperature, is suitable for treating a wide range of viscous flow problems and is implemented for brick and shell elements. Load curves are used to represent the temperature dependence of Poisson's ratio, Young's modulus, the coefficient of expansion, and the viscosity.

Card 1	1	2	3	4	5	6	7	8
Variable	MID	RO	V0	A	B	C	LCID	
Type	A8	F	F	F	F	F	F	

Card 2	1	2	3	4	5	6	7	8
Variable	PR_LC	YM_LC	A_LC	V_LC	V_LOG			
Type	F	F	F	F	F			

VARIABLE**DESCRIPTION**

MID	Material identification. A unique number or label not exceeding 8 characters must be specified.
RO	Mass density
V0	Temperature independent dynamic viscosity coefficient, V_0 . If defined, the temperature dependent viscosity defined below is skipped, see type (i) and (ii) definitions for viscosity below.
A	Dynamic viscosity coefficient, see type (i) and (ii) definitions below.
B	Dynamic viscosity coefficient, see type (i) and (ii) definitions below.
C	Dynamic viscosity coefficient, see type (i) and (ii) definitions below.
LCID	Load curve (see *DEFINE_CURVE) defining factor on dynamic viscosity versus temperature, see type (iii). (Optional).

VARIABLE	DESCRIPTION
PR_LC	Load curve (see *DEFINE_CURVE) defining Poisson's ratio as a function of temperature.
YM_LC	Load curve (see *DEFINE_CURVE) defining Young's modulus as a function of temperature.
A_LC	Load curve (see *DEFINE_CURVE) defining the coefficient of thermal expansion as a function of temperature.
V_LC	Load curve (see *DEFINE_CURVE) defining the dynamic viscosity as a function of temperature.
V_LOG	Flag for the form of V_LC. If V_LOG = 1.0, the value specified in V_LC is the natural logarithm of the viscosity, ln(V). The value interpolated from the curve is then exponentiated to obtain the viscosity. If V_LOG = 0.0, the value is the viscosity. The logarithmic form is useful if the value of the viscosity changes by orders of magnitude over the temperature range of the data.

Remarks:

Volumetric behavior is treated as linear elastic. The deviatoric strain rate is considered to be the sum of elastic and viscous strain rates:

$$\dot{\boldsymbol{\epsilon}}'_{\text{total}} = \dot{\boldsymbol{\epsilon}}'_{\text{elastic}} + \dot{\boldsymbol{\epsilon}}'_{\text{viscous}} = \frac{\boldsymbol{\sigma}'}{2G} + \frac{\boldsymbol{\sigma}'}{2\nu}$$

where G is the elastic shear modulus, ν is the viscosity coefficient, and bold~ indicates a tensor. The stress increment over one timestep dt is

$$d\boldsymbol{\sigma}' = 2G\dot{\boldsymbol{\epsilon}}'_{\text{total}} dt - \frac{G}{\nu} dt \boldsymbol{\sigma}'$$

The stress before the update is used for $\boldsymbol{\sigma}'$. For shell elements the through-thickness strain rate is calculated as follows.

$$d\sigma_{33} = 0 = K(\dot{\epsilon}_{11} + \dot{\epsilon}_{22} + \dot{\epsilon}_{33})dt + 2G\dot{\epsilon}'_{33}dt - \frac{G}{\nu}dt\sigma'_{33}$$

where the subscript ij = 33 denotes the through-thickness direction and K is the elastic bulk modulus. This leads to:

$$\dot{\epsilon}_{33} = -a(\dot{\epsilon}_{11} + \dot{\epsilon}_{22}) + bp$$

$$a = \frac{\left(K - \frac{2}{3}G\right)}{\left(K + \frac{4}{3}G\right)}$$

$$b = \frac{Gdt}{v\left(K + \frac{4}{3}G\right)}$$

in which p is the pressure defined as the negative of the hydrostatic stress.

The variation of viscosity with temperature can be defined in any one of the 3 ways.

- (i) Constant, $V = V_0$ Do not define constants, A, B, and C or the piecewise curve.(leave card 4 blank)
- (ii) $V = V_0 \times 10^{(A/(T-B) + C)}$
- (iii) Piecewise curve: define the variation of viscosity with temperature.

Note: Viscosity is inactive during dynamic relaxation.

***MAT_KELVIN-MAXWELL_VISCOELASTIC**

This is Material Type 61. This material is a classical Kelvin-Maxwell model for modeling viscoelastic bodies, e.g., foams. This model is valid for solid elements only. See also notes below.

Card 1	1	2	3	4	5	6	7	8
Variable	MID	RO	BULK	G0	GI	DC	FO	S0
Type	A8	F	F	F	F	F	F	F
Default	none	none	none	none	none	0.0	0.0	0.0

VARIABLE**DESCRIPTION**

MID	Material identification. A unique number or label not exceeding 8 characters must be specified.
RO	Mass density
BULK	Bulk modulus (elastic)
G0	Short-time shear modulus, G_0
GI	Long-time (infinite) shear modulus, G_∞
DC	Maxwell decay constant, β [FO = 0.0] or Kelvin relaxation constant, τ [FO = 1.0]
FO	Formulation option: EQ.0.0: Maxwell, EQ.1.0: Kelvin.

VARIABLE	DESCRIPTION
SO	<p>Strain (logarithmic) output option to control what is written as component 7 to the d3plot database. (LS-PrePost always blindly labels this component as effective plastic strain.) The maximum values are updated for each element each time step:</p> <p>EQ.0.0: maximum principal strain that occurs during the calculation,</p> <p>EQ.1.0: maximum magnitude of the principal strain values that occurs during the calculation,</p> <p>EQ.2.0: maximum effective strain that occurs during the calculation.</p>

Remarks:

The shear relaxation behavior is described for the Maxwell model by:

$$G(t) = G + (G_0 - G_\infty)e^{-\beta t}$$

A Jaumann rate formulation is used

$$\overset{\nabla}{\sigma}'_{ij} = 2 \int_0^t G(t - \tau) D'_{ij}(\tau) dt$$

where the prime denotes the deviatoric part of the stress rate, $\overset{\nabla}{\sigma}'_{ij}$, and the strain rate D_{ij} . For the Kelvin model the stress evolution equation is defined as:

$$\dot{s}_{ij} + \frac{1}{\tau} s_{ij} = (1 + \delta_{ij}) G_0 \dot{e}_{ij} + (1 + \delta_{ij}) \frac{G_\infty}{\tau} \dot{e}_{ij}$$

The strain data as written to the LS-DYNA database may be used to predict damage, see [Bandak 1991].

***MAT_VISCOUS_FOAM**

This is Material Type 62. It was written to represent the Confor Foam on the ribs of EuroSID side impact dummy. It is only valid for solid elements, mainly under compressive loading.

Card 1	1	2	3	4	5	6	7	8
Variable	MID	RO	E1	N1	V2	E2	N2	PR
Type	A8	F	F	F	F	F	F	F

<u>VARIABLE</u>	<u>DESCRIPTION</u>
MID	Material identification. A unique number or label not exceeding 8 characters must be specified.
RO	Mass density
E1	Initial Young's modulus (E_1)
N1	Exponent in power law for Young's modulus (n_1)
V2	Viscous coefficient (V_2)
E2	Elastic modulus for viscosity (E_2), see notes below.
N2	Exponent in power law for viscosity (n_2)
PR	Poisson's ratio, ν

Remarks:

The model consists of a nonlinear elastic stiffness in parallel with a viscous damper. The elastic stiffness is intended to limit total crush while the viscosity absorbs energy. The stiffness E_2 exists to prevent timestep problems. It is used for time step calculations as long as E_1^t is smaller than E_2 . It has to be carefully chosen to take into account the stiffening effects of the viscosity. Both E_1 and V_2 are nonlinear with crush as follows:

$$E_1^t = E_1(V^{-n_1})$$

$$V_2^t = V_2|1 - V|^{n_2}$$

where viscosity generates a shear stress given by

$$\tau = V_2\dot{\gamma}$$

$\dot{\gamma}$ is the engineering shear strain rate, and V is the relative volume defined by the ratio of the current to initial volume.

Table showing typical values (units of N, mm, s):

Card 1	1	2	3	4	5	6	7	8
Variable	MID	R0	E1	N1	V2	E2	N2	PR
Value			0.0036	4.0	0.0015	100.0	0.2	0.05

***MAT_CRUSHABLE_FOAM**

This is Material Type 63 which is dedicated to modeling crushable foam with optional damping and tension cutoff. Unloading is fully elastic. Tension is treated as elastic-perfectly-plastic at the tension cut-off value. A modified version of this model, *MAT_MODIFIED_CRUSHABLE_FOAM includes strain rate effects.

Card 1	1	2	3	4	5	6	7	8
Variable	MID	RO	E	PR	LCID	TSC	DAMP	
Type	A8	F	F	F	F	F	F	
Default	none	none	none	none	none	0.0	0.10	

VARIABLE**DESCRIPTION**

MID	Material identification. A unique number or label not exceeding 8 characters must be specified.
RO	Mass density
E	Young's modulus
PR	Poisson's ratio
LCID	Load curve ID defining yield stress versus volumetric strain, γ , see Figure 2-34 .
TSC	Tensile stress cutoff. A nonzero, positive value is strongly recommended for realistic behavior.
DAMP	Rate sensitivity via damping coefficient ($.05 <$ recommended value $< .50$).

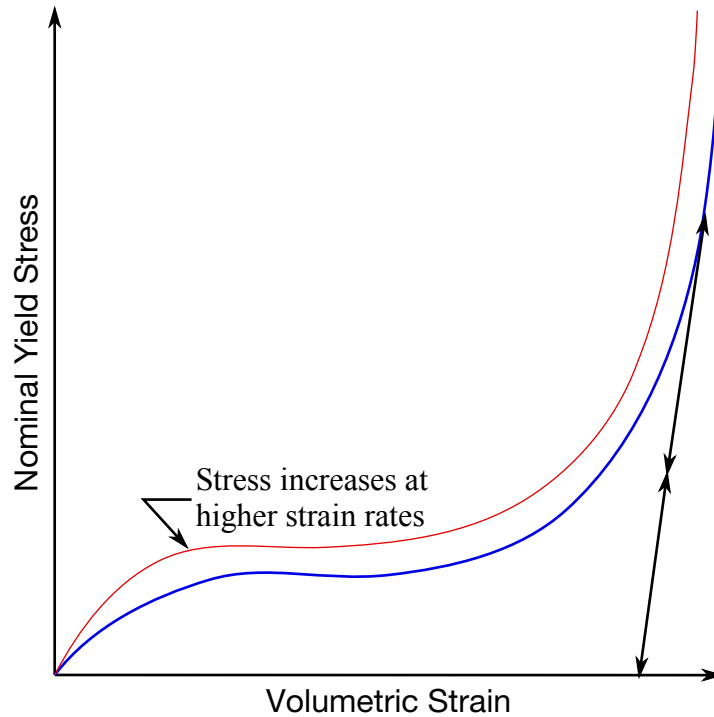

Figure 2-34. Behavior of strain rate sensitive crushable foam. Unloading is elastic to the tension cutoff. Subsequent reloading follows the unloading curve.

Remarks:

The volumetric strain is defined in terms of the relative volume, V , as:

$$\gamma = 1 - V$$

The relative volume is defined as the ratio of the current to the initial volume. In place of the effective plastic strain in the D3PLOT database, the integrated volumetric strain is output.

***MAT_RATE_SENSITIVE_POWERLAW_PLASTICITY**

This is Material Type 64 which will model strain rate sensitive elasto-plastic material with a power law hardening. Optionally, the coefficients can be defined as functions of the effective plastic strain.

Card 1	1	2	3	4	5	6	7	8
Variable	MID	RO	E	PR	K	M	N	E0
Type	A8	F	F	F	F	F	F	F
Default	none	none	none	none	none	0.0001	none	0.0002

Card 2	1	2	3	4	5	6	7	8
Variable	VP	EPS0						
Type	F	F						
Default	0.0	1.0						

VARIABLE**DESCRIPTION**

MID	Material identification. A unique number or label not exceeding 8 characters must be specified.
RO	Mass density
E	Young's modulus of elasticity
PR	Poisson's ratio
K	Material constant, k. If $k < 0$ the absolute value of k is taken as the load curve number that defines k as a function of effective plastic strain.
M	Strain hardening coefficient, m. If $m < 0$ the absolute value of m is taken as the load curve number that defines m as a function of effective plastic strain.

VARIABLE	DESCRIPTION
N	Strain rate sensitivity coefficient, n. If n < 0 the absolute value of n is taken as the load curve number that defines n as a function of effective plastic strain.
E0	Initial strain rate (default = 0.0002)
VP	Formulation for rate effects: EQ.0.0: Scale yield stress (default) EQ.1.0: Viscoplastic formulation
EPS0	Quasi-static threshold strain rate. See description under *MAT_015.

Remarks:

This material model follows a constitutive relationship of the form:

$$\sigma = k\varepsilon^m \dot{\varepsilon}^n$$

where σ is the yield stress, ε is the effective plastic strain, $\dot{\varepsilon}$ is the effective total strain rate (VP = 0), respectively the effective plastic strain rate (VP = 1), and the constants k , m , and n can be expressed as functions of effective plastic strain or can be constant with respect to the plastic strain. The case of no strain hardening can be obtained by setting the exponent of the plastic strain equal to a very small positive value, i.e. 0.0001.

This model can be combined with the superplastic forming input to control the magnitude of the pressure in the pressure boundary conditions in order to limit the effective plastic strain rate so that it does not exceed a maximum value at any integration point within the model.

A fully viscoplastic formulation is optional. An additional cost is incurred but the improvement in results can be dramatic.

***MAT_MODIFIED_ZERILLI_ARMSTRONG**

This is Material Type 65 which is a rate and temperature sensitive plasticity model which is sometimes preferred in ordnance design calculations.

Card 1	1	2	3	4	5	6	7	8
Variable	MID	RO	G	E0	N	TROOM	PC	SPALL
Type	A8	F	F	F	F	F	F	F

Card 2	1	2	3	4	5	6	7	8
Variable	C1	C2	C3	C4	C5	C6	EFAIL	VP
Type	F	F	F	F	F	F	F	F

Card 3	1	2	3	4	5	6	7	8
Variable	B1	B2	B3	G1	G2	G3	G4	BULK
Type	F	F	F	F	F	F	F	

VARIABLE**DESCRIPTION**

MID	Material identification. A unique number or label not exceeding 8 characters must be specified.
RO	Mass density
G	Shear modulus
E0	$\dot{\epsilon}_0$, factor to normalize strain rate
N	n, exponent for bcc metal
TROOM	T_r , room temperature
PC	p_c , Pressure cutoff

VARIABLE	DESCRIPTION
SPALL	Spall Type: EQ.1.0: minimum pressure limit, EQ.2.0: maximum principal stress, EQ.3.0: minimum pressure cutoff.
C1	C ₁ , coefficients for flow stress, see notes below.
C2	C ₂ , coefficients for flow stress, see notes below.
C3	C ₃ , coefficients for flow stress, see notes below.
C4	C ₄ , coefficients for flow stress, see notes below.
C5	C ₅ , coefficients for flow stress, see notes below.
C6	C ₆ , coefficients for flow stress, see notes below.
EFAIL	Failure strain for erosion
VP	Formulation for rate effects: EQ.0.0: Scale yield stress (default) EQ.1.0: Viscoplastic formulation
B1	B ₁ , coefficients for polynomial to represent temperature dependency of flow stress yield.
B2	B ₂
B3	B ₃
G1	G ₁ , coefficients for defining heat capacity and temperature dependency of heat capacity.
G2	G ₂
G3	G ₃
G4	G ₄
BULK	Bulk modulus defined for shell elements only. Do not input for solid elements.

Remarks:

The Armstrong-Zerilli Material Model expresses the flow stress as follows.

For fcc metals (n = 0),

$$\sigma = C_1 + \left\{ C_2(\epsilon^p)^{1/2} [e^{[-C_3 + C_4 \ln(\dot{\epsilon}^*)]T}] + C_5 \right\} \left[\frac{\mu(T)}{\mu(293)} \right]$$

where,

ϵ^p = effective plastic strain

$\dot{\epsilon}^*$ = effective plastic strain rate

$$= \frac{\dot{\epsilon}}{\dot{\epsilon}_0}$$

and $\dot{\epsilon}_0 = 1, 1e-3, 1e-6$ for time units of seconds, milliseconds, and microseconds, respectively.

For bcc metals (n > 0),

$$\sigma = C_1 + C_2 e^{[-C_3 + C_4 \ln(\dot{\epsilon}^*)]T} + [C_5(\epsilon^p)^n + C_6] \left[\frac{\mu(T)}{\mu(293)} \right]$$

where

$$\frac{\mu(T)}{\mu(293)} = B_1 + B_2 T + B_3 T^2.$$

The relationship between heat capacity (specific heat) and temperature may be characterized by a cubic polynomial equation as follows:

$$C_p = G_1 + G_2 T + G_3 T^2 + G_4 T^3$$

A fully viscoplastic formulation is optional. An additional cost is incurred but the improvement in results can be dramatic.

***MAT_LINEAR_ELASTIC_DISCRETE_BEAM**

This is Material Type 66. This material model is defined for simulating the effects of a linear elastic beam by using six springs each acting about one of the six local degrees-of-freedom. The two nodes defining a beam may be coincident to give a zero length beam, or offset to give a finite length beam. For finite length discrete beams the absolute value of the variable SCOOOR in the SECTION_BEAM input should be set to a value of 2.0, which causes the local r-axis to be aligned along the two nodes of the beam to give physically correct behavior. The distance between the nodes of a beam should not affect the behavior of this model. A triad is used to orient the beam for the directional springs. Translational/rotational stiffness and viscous damping effects are considered for a local cartesian system, see notes below. Applications for this element include the modeling of joint stiffnesses.

Card 1	1	2	3	4	5	6	7	8
Variable	MID	RO	TKR	TKS	TKT	RKR	RKS	RKT
Type	A8	F	F	F	F	F	F	F

Card 2	1	2	3	4	5	6	7	8
Variable	TDR	TDS	TDT	RDR	RDS	RDT		
Type	F	F	F	F	F	F		

Card 3	1	2	3	4	5	6	7	8
Variable	FOR	FOS	FOT	MOR	MOS	MOT		
Type	F	F	F	F	F	F		

VARIABLE**DESCRIPTION**

MID	Material identification. A unique number or label not exceeding 8 characters must be specified.
RO	Mass density, see also "volume" in the *SECTION_BEAM definition.

VARIABLE	DESCRIPTION
TKR	Translational stiffness along local r-axis, see notes below.
TKS	Translational stiffness along local s-axis.
TKT	Translational stiffness along local t-axis.
RKR	Rotational stiffness about the local r-axis.
RKS	Rotational stiffness about the local s-axis.
RKT	Rotational stiffness about the local t-axis.
TDR	Translational viscous damper along local r-axis. (Optional)
TDS	Translational viscous damper along local s-axis. (Optional)
TDT	Translational viscous damper along local t-axis. (Optional)
RDR	Rotational viscous damper about the local r-axis. (Optional)
RDS	Rotational viscous damper about the local s-axis. (Optional)
RDT	Rotational viscous damper about the local t-axis. (Optional)
FOR	Preload force in r-direction. (Optional)
FOS	Preload force in s-direction. (Optional)
FOT	Preload force in t-direction. (Optional)
MOR	Preload moment about r-axis. (Optional)
MOS	Preload moment about s-axis. (Optional)
MOT	Preload moment about t-axis. (Optional)

Remarks:

The formulation of the discrete beam (type 6) assumes that the beam is of zero length and requires no orientation node. A small distance between the nodes joined by the beam is permitted. The local coordinate system which determines (r,s,t) is given by the coordinate ID, see *DEFINE_COORDINATE_OPTION, in the cross sectional input, see *SECTION_BEAM, where the global system is the default. The local coordinate system axes can rotate with either node of the beam or an average rotation of both nodes (see SCOOR variable in *SECTION_BEAM).

For null stiffness coefficients, no forces corresponding to these null values will develop. The viscous damping coefficients are optional.

***MAT_NONLINEAR_ELASTIC_DISCRETE_BEAM**

This is Material Type 67. This material model is defined for simulating the effects of non-linear elastic and nonlinear viscous beams by using six springs each acting about one of the six local degrees-of-freedom. The two nodes defining a beam may be coincident to give a zero length beam, or offset to give a finite length beam. For finite length discrete beams the absolute value of the variable SCOOOR in the SECTION_BEAM input should be set to a value of 2.0, which causes the local r-axis to be aligned along the two nodes of the beam to give physically correct behavior. The distance between the nodes of a beam should not affect the behavior of this material model. A triad is used to orient the beam for the directional springs. Arbitrary curves to model transitional/ rotational stiffness and damping effects are allowed. See notes below.

Card 1	1	2	3	4	5	6	7	8
Variable	MID	RO	LCIDTR	LCIDTS	LCIDTT	LCIDRR	LCIDRS	LCIDRT
Type	A8	F	F	F	F	F	F	F

Card 2	1	2	3	4	5	6	7	8
Variable	LCIDTDR	LCIDTDS	LCIDTDT	LCIDRDR	LCIDRDS	LCIDRDT		
Type	F	F	F	F	F	F		

Card 3	1	2	3	4	5	6	7	8
Variable	FOR	FOS	FOT	MOR	MOS	MOT		
Type	F	F	F	F	F	F		

Optional Failure Cards. Cards 4 and 5 must be defined to consider failure; otherwise, they are optional.

Card 4	1	2	3	4	5	6	7	8
Variable	FFAILR	FFAILS	FFAILT	MFAILR	MFAILS	MFAILT		
Type	F	F	F	F	F	F		
Default	0.0	0.0	0.0	0.0	0.0	0.0		

Card 5	1	2	3	4	5	6	7	8
Variable	UFAILR	UFAILS	UFAILT	TFAILR	TFAILS	TFAILT		
Type	F	F	F	F	F	F		
Default	0.0	0.0	0.0	0.0	0.0	0.0		

VARIABLE**DESCRIPTION**

MID	Material identification. A unique number or label not exceeding 8 characters must be specified.
RO	Mass density, see also volume in *SECTION_BEAM definition.
LCIDTR	Load curve ID defining translational force resultant along local r-axis versus relative translational displacement, see Remarks and Figure 2-35 .
LCIDTS	Load curve ID defining translational force resultant along local s-axis versus relative translational displacement.
LCIDTT	Load curve ID defining translational force resultant along local t-axis versus relative translational displacement.
LCIDRR	Load curve ID defining rotational moment resultant about local r-axis versus relative rotational displacement.
LCIDRS	Load curve ID defining rotational moment resultant about local s-axis versus relative rotational displacement.

VARIABLE	DESCRIPTION
LCIDRT	Load curve ID defining rotational moment resultant about local t-axis versus relative rotational displacement.
LCIDTDR	Load curve ID defining translational damping force resultant along local r-axis versus relative translational velocity.
LCIDTDS	Load curve ID defining translational damping force resultant along local s-axis versus relative translational velocity.
LCIDTDT	Load curve ID defining translational damping force resultant along local t-axis versus relative translational velocity.
LCIDRDR	Load curve ID defining rotational damping moment resultant about local r-axis versus relative rotational velocity.
LCIDRDS	Load curve ID defining rotational damping moment resultant about local s-axis versus relative rotational velocity.
LCIDRDT	Load curve ID defining rotational damping moment resultant about local t-axis versus relative rotational velocity.
FOR	Preload force in r-direction. (Optional)
FOS	Preload force in s-direction. (Optional)
FOT	Preload force in t-direction. (Optional)
MOR	Preload moment about r-axis. (Optional)
MOS	Preload moment about s-axis. (Optional)
MOT	Preload moment about t-axis. (Optional)
FFAILR	Optional failure parameter. If zero, the corresponding force, F_r , is not considered in the failure calculation.
FFAILS	Optional failure parameter. If zero, the corresponding force, F_s , is not considered in the failure calculation.
FFAILT	Optional failure parameter. If zero, the corresponding force, F_t , is not considered in the failure calculation.
MFAILR	Optional failure parameter. If zero, the corresponding moment, M_r , is not considered in the failure calculation.

VARIABLE	DESCRIPTION
MFAILS	Optional failure parameter. If zero, the corresponding moment, M_s , is not considered in the failure calculation.
MFAILT	Optional failure parameter. If zero, the corresponding moment, M_t , is not considered in the failure calculation.
UFAILR	Optional failure parameter. If zero, the corresponding displacement, u_r , is not considered in the failure calculation.
UFAILS	Optional failure parameter. If zero, the corresponding displacement, u_s , is not considered in the failure calculation.
UFAILT	Optional failure parameter. If zero, the corresponding displacement, u_t , is not considered in the failure calculation.
TFAILR	Optional failure parameter. If zero, the corresponding rotation, θ_r , is not considered in the failure calculation.
TFAILS	Optional failure parameter. If zero, the corresponding rotation, θ_s , is not considered in the failure calculation.
TFAILT	Optional failure parameter. If zero, the corresponding rotation, θ_t , is not considered in the failure calculation.

Remarks:

For null load curve ID's, no forces are computed.

The formulation of the discrete beam (type 6) assumes that the beam is of zero length and requires no orientation node. A small distance between the nodes joined by the beam is permitted. The local coordinate system which determines (r,s,t) is given by the coordinate ID, see *DEFINE_COORDINATE_OPTION, in the cross sectional input, see *SECTION_BEAM, where the global system is the default. The local coordinate system axes can rotate with either node of the beam or an average rotation of both nodes (see SCOOR variable in *SECTION_BEAM).

If different behavior in tension and compression is desired in the calculation of the force resultants, the load curve(s) must be defined in the negative quadrant starting with the most negative displacement then increasing monotonically to the most positive. If the load curve behaves similarly in tension and compression, define only the positive quadrant. Whenever displacement values fall outside of the defined range, the resultant forces will be extrapolated. [Figure 2-35](#) depicts a typical load curve for a force resultant. Load curves used for determining the damping forces and moment resultants always act identically in

tension and compression, since only the positive quadrant values are considered, i.e., start the load curve at the origin [0,0].

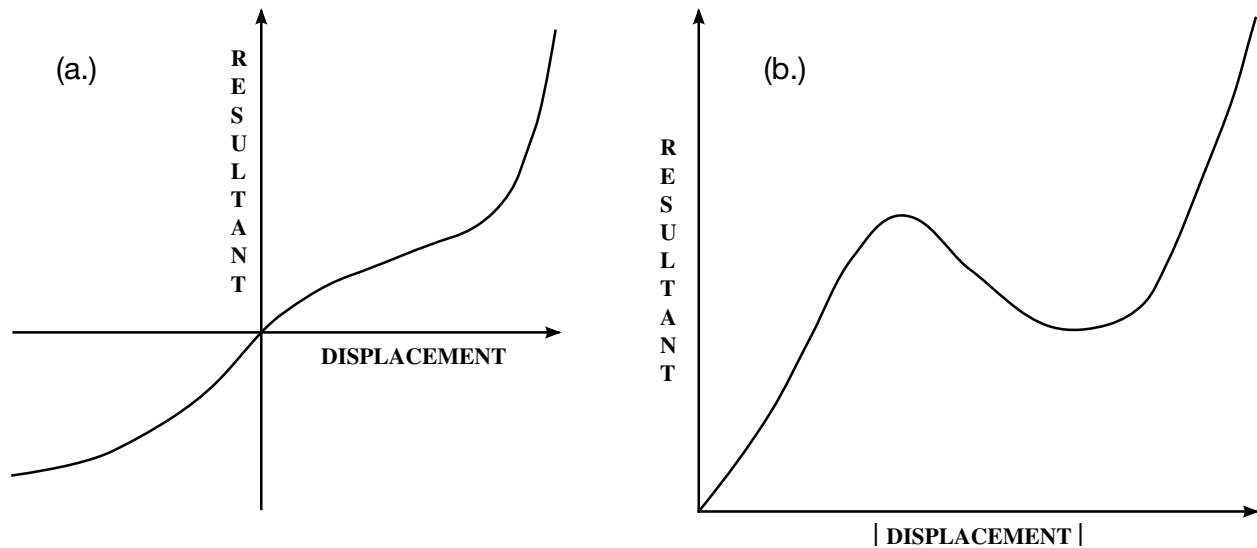

Figure 2-35. The resultant forces and moments are determined by a table lookup. If the origin of the load curve is at [0,0] as in (b.) and tension and compression responses are symmetric.

Catastrophic failure based on force resultants occurs if the following inequality is satisfied.

$$\left(\frac{F_r}{F_r^{\text{fail}}}\right)^2 + \left(\frac{F_s}{F_s^{\text{fail}}}\right)^2 + \left(\frac{F_t}{F_t^{\text{fail}}}\right)^2 + \left(\frac{M_r}{M_r^{\text{fail}}}\right)^2 + \left(\frac{M_s}{M_s^{\text{fail}}}\right)^2 + \left(\frac{M_t}{M_t^{\text{fail}}}\right)^2 - 1. \geq 0.$$

After failure the discrete element is deleted. Likewise, catastrophic failure based on displacement resultants occurs if the following inequality is satisfied:

$$\left(\frac{u_r}{u_r^{\text{fail}}}\right)^2 + \left(\frac{u_s}{u_s^{\text{fail}}}\right)^2 + \left(\frac{u_t}{u_t^{\text{fail}}}\right)^2 + \left(\frac{\theta_r}{\theta_r^{\text{fail}}}\right)^2 + \left(\frac{\theta_s}{\theta_s^{\text{fail}}}\right)^2 + \left(\frac{\theta_t}{\theta_t^{\text{fail}}}\right)^2 - 1. \geq 0.$$

After failure the discrete element is deleted. If failure is included either one or both of the criteria may be used.

***MAT_NONLINEAR_PLASTIC_DISCRETE_BEAM**

This is Material Type 68. This material model is defined for simulating the effects of non-linear elastoplastic, linear viscous behavior of beams by using six springs each acting about one of the six local degrees-of-freedom. The two nodes defining a beam may be coincident to give a zero length beam, or offset to give a finite length beam. For finite length discrete beams the absolute value of the variable SCOOR in the SECTION_BEAM input should be set to a value of 2.0, which causes the local r-axis to be aligned along the two nodes of the beam to give physically correct behavior. The distance between the nodes of a beam should not affect the behavior of this material model. A triad is used to orient the beam for the directional springs. Translational/rotational stiffness and damping effects can be considered. The plastic behavior is modeled using force/moment curves versus displacements/rotation. Optionally, failure can be specified based on a force/moment criterion and a displacement rotation criterion. See also notes below.

Card 1	1	2	3	4	5	6	7	8
Variable	MID	RO	TKR	TKS	TKT	RKR	RKS	RKT
Type	A8	F	F	F	F	F	F	F
Default	none	none	none	none	none	none	none	none

Card 2	1	2	3	4	5	6	7	8
Variable	TDR	TDS	TDT	RDR	RDS	RDT		
Type	F	F	F	F	F	F		
Default	none	none	none	none	none	none		

Card 3	1	2	3	4	5	6	7	8
Variable	LCPDR	LCPDS	LCPDT	LCPMR	LCPMS	LCPMT		
Type	F	F	F	F	F	F		
Default	0.0	0.0	0.0	0.0	0.0	0.0		

Card 4	1	2	3	4	5	6	7	8
Variable	FFAILR	FFAILS	FFAILT	MFAILR	MFAILS	MFAILT		
Type	F	F	F	F	F	F		
Default	0.0	0.0	0.0	0.0	0.0	0.0		

Card 5	1	2	3	4	5	6	7	8
Variable	UFAILR	UFAILS	UFAILT	TFAILR	TFAILS	TFAILT		
Type	F	F	F	F	F	F		
Default	0.0	0.0	0.0	0.0	0.0	0.0		

Card 6	1	2	3	4	5	6	7	8
Variable	FOR	FOS	FOT	MOR	MOS	MOT		
Type	F	F	F	F	F	F		

VARIABLE

DESCRIPTION

- MID Material identification. A unique number or label not exceeding 8 characters must be specified.
- RO Mass density, see also volume on *SECTION_BEAM definition.
- TKR Translational stiffness along local r-axis
- TKS Translational stiffness along local s-axis
- TKT Translational stiffness along local t-axis
- RKR Rotational stiffness about the local r-axis
- RKS Rotational stiffness about the local s-axis

VARIABLE	DESCRIPTION
RKT	Rotational stiffness about the local t-axis
TDR	Translational viscous damper along local r-axis
TDS	Translational viscous damper along local s-axis
TDT	Translational viscous damper along local t-axis
RDR	Rotational viscous damper about the local r-axis
RDS	Rotational viscous damper about the local s-axis
RDT	Rotational viscous damper about the local t-axis
LCPDR	Load curve ID-yield force versus plastic displacement r-axis. If the curve ID is zero, and if TKR is nonzero, then elastic behavior is obtained for this component.
LCPDS	Load curve ID-yield force versus plastic displacement s-axis. If the curve ID is zero, and if TKS is nonzero, then elastic behavior is obtained for this component.
LCPDT	Load curve ID-yield force versus plastic displacement t-axis. If the curve ID is zero, and if TKT is nonzero, then elastic behavior is obtained for this component.
LCPMR	Load curve ID-yield moment versus plastic rotation r-axis. If the curve ID is zero, and if RKR is nonzero, then elastic behavior is obtained for this component.
LCPMS	Load curve ID-yield moment versus plastic rotation s-axis. If the curve ID is zero, and if RKS is nonzero, then elastic behavior is obtained for this component.
LCPMT	Load curve ID-yield moment versus plastic rotation t-axis. If the curve ID is zero, and if RKT is nonzero, then elastic behavior is obtained for this component.
FFAILR	Optional failure parameter. If zero, the corresponding force, F_r , is not considered in the failure calculation.
FFAILS	Optional failure parameter. If zero, the corresponding force, F_s , is not considered in the failure calculation.

VARIABLE	DESCRIPTION
FFAILT	Optional failure parameter. If zero, the corresponding force, F_t , is not considered in the failure calculation.
MFAILR	Optional failure parameter. If zero, the corresponding moment, M_r , is not considered in the failure calculation.
MFAILS	Optional failure parameter. If zero, the corresponding moment, M_s , is not considered in the failure calculation.
MFAILT	Optional failure parameter. If zero, the corresponding moment, M_t , is not considered in the failure calculation.
UFAILR	Optional failure parameter. If zero, the corresponding displacement, u_r , is not considered in the failure calculation.
UFAILS	Optional failure parameter. If zero, the corresponding displacement, u_s , is not considered in the failure calculation.
UFAILT	Optional failure parameter. If zero, the corresponding displacement, u_t , is not considered in the failure calculation.
TFAILR	Optional failure parameter. If zero, the corresponding rotation, θ_r , is not considered in the failure calculation.
TFAILS	Optional failure parameter. If zero, the corresponding rotation, θ_s , is not considered in the failure calculation.
TFAILT	Optional failure parameter. If zero, the corresponding rotation, θ_t , is not considered in the failure calculation.
FOR	Preload force in r-direction. (Optional)
FOS	Preload force in s-direction. (Optional)
FOT	Preload force in t-direction. (Optional)
MOR	Preload moment about r-axis. (Optional)
MOS	Preload moment about s-axis. (Optional)
MOT	Preload moment about t-axis. (Optional)

Remarks:

For the translational and rotational degrees of freedom where elastic behavior is desired, set the load curve ID to zero.

The plastic displacement for the load curves is defined as:

$$\text{plastic displacement} = \text{total displacement} - \text{yield force/elastic stiffness}$$

The formulation of the discrete beam (type 6) assumes that the beam is of zero length and requires no orientation node. A small distance between the nodes joined by the beam is permitted. The local coordinate system which determines (r,s,t) is given by the coordinate ID (see *DEFINE_COORDINATE_OPTION) in the cross sectional input, see *SECTION_BEAM, where the global system is the default. The local coordinate system axes can rotate with either node of the beam or an average rotation of both nodes (see SCOOR variable in *SECTION_BEAM).

Catastrophic failure based on force resultants occurs if the following inequality is satisfied.

$$\left(\frac{F_r}{F_r^{\text{fail}}}\right)^2 + \left(\frac{F_s}{F_s^{\text{fail}}}\right)^2 + \left(\frac{F_t}{F_t^{\text{fail}}}\right)^2 + \left(\frac{M_r}{M_r^{\text{fail}}}\right)^2 + \left(\frac{M_s}{M_s^{\text{fail}}}\right)^2 + \left(\frac{M_t}{M_t^{\text{fail}}}\right)^2 - 1. \geq 0.$$

After failure the discrete element is deleted. Likewise, catastrophic failure based on displacement resultants occurs if the following inequality is satisfied:

$$\left(\frac{u_r}{u_r^{\text{fail}}}\right)^2 + \left(\frac{u_s}{u_s^{\text{fail}}}\right)^2 + \left(\frac{u_t}{u_t^{\text{fail}}}\right)^2 + \left(\frac{\theta_r}{\theta_r^{\text{fail}}}\right)^2 + \left(\frac{\theta_s}{\theta_s^{\text{fail}}}\right)^2 + \left(\frac{\theta_t}{\theta_t^{\text{fail}}}\right)^2 - 1. \geq 0.$$

After failure the discrete element is deleted. If failure is included either one or both of the criteria may be used.

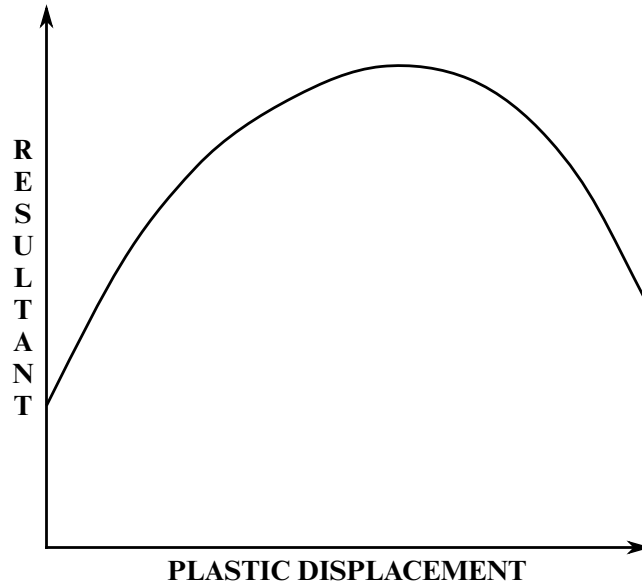

Figure 2-36. The resultant forces and moments are limited by the yield definition. The initial yield point corresponds to a plastic displacement of zero.

***MAT_SID_DAMPER_DISCRETE_BEAM**

This is Material Type 69. The side impact dummy uses a damper that is not adequately treated by the nonlinear force versus relative velocity curves since the force characteristics are dependent on the displacement of the piston. See also notes below.

Card 1	1	2	3	4	5	6	7	8
Variable	MID	RO	ST	D	R	H	K	C
Type	A8	F	F	F	F	F	F	F

Card 2	1	2	3	4	5	6	7	8
Variable	C3	STF	RHOF	C1	C2	LCIDF	LCIDD	S0
Type	F	F	F	F	F	F	F	F

Orifice Cards. Include on card per orifice. Read in up to 15 orifice locations. Input is terminated when a "*" card is found. On the first card below the optional input parameters SF and DF may be specified.

Cards 3	1	2	3	4	5	6	7	8
Variable	ORFLOC	ORFRAD	SF	DC				
Type	F	F	F	F				

VARIABLE**DESCRIPTION**

MID	Material identification. A unique number or label not exceeding 8 characters must be specified.
RO	Mass density, see also volume on *SECTION_BEAM definition.
ST	S_t , piston stroke. S_t must equal or exceed the length of the beam element, see Figure 2-37 below.
D	d, piston diameter
R	R, default orifice radius

VARIABLE	DESCRIPTION
H	h, orifice controller position
K	K, damping constant LT.0.0: $ K $ is the load curve number ID, see *DEFINE_CURVE, defining the damping coefficient as a function of the absolute value of the relative velocity.
C	C, discharge coefficient
C3	Coefficient for fluid inertia term
STF	k, stiffness coefficient if piston bottoms out
RHOF	ρ_{fluid} , fluid density
C1	C_1 , coefficient for linear velocity term
C2	C_2 , coefficient for quadratic velocity term
LCIDF	Load curve number ID defining force versus piston displacement, s , i.e., term $f(s + s_0)$. Compressive behavior is defined in the positive quadrant of the force displacement curve. Displacements falling outside of the defined force displacement curve are extrapolated. Care must be taken to ensure that extrapolated values are reasonable.
LCIDD	Load curve number ID defining damping coefficient versus piston displacement, s , i.e., $g(s + s_0)$. Displacements falling outside the defined curve are extrapolated. Care must be taken to ensure that extrapolated values are reasonable.
S0	Initial displacement s_0 , typically set to zero. A positive displacement corresponds to compressive behavior.
ORFLOC	d_i , orifice location of i th orifice relative to the fixed end.
ORFRAD	r_i , orifice radius of i th orifice, if zero the default radius is used.
SF	Scale factor on calculated force. The default is set to 1.0
DC	c , linear viscous damping coefficient used after damper bottoms out either in tension or compression.

Remarks:

As the damper moves, the fluid flows through the open orifices to provide the necessary damping resistance. While moving as shown in [Figure 2-37](#) the piston gradually blocks off and effectively closes the orifices. The number of orifices and the size of their opening control the damper resistance and performance. The damping force is computed from,

$$F = SF \times \left\{ KA_p V_p \left\{ \frac{C_1}{A_0^t} + C_2 |V_p| \rho_{\text{fluid}} \left[\left(\frac{A_p}{CA_0^t} \right)^2 - 1 \right] \right\} - f(s + s_0) + V_p g(s + s_0) \right\}$$

where K is a user defined constant or a tabulated function of the absolute value of the relative velocity, V_p is the piston velocity, C is the discharge coefficient, A_p is the piston area, A_0^t is the total open areas of orifices at time t, ρ_{fluid} is the fluid density, C_1 is the coefficient for the linear term, and C_2 is the coefficient for the quadratic term.

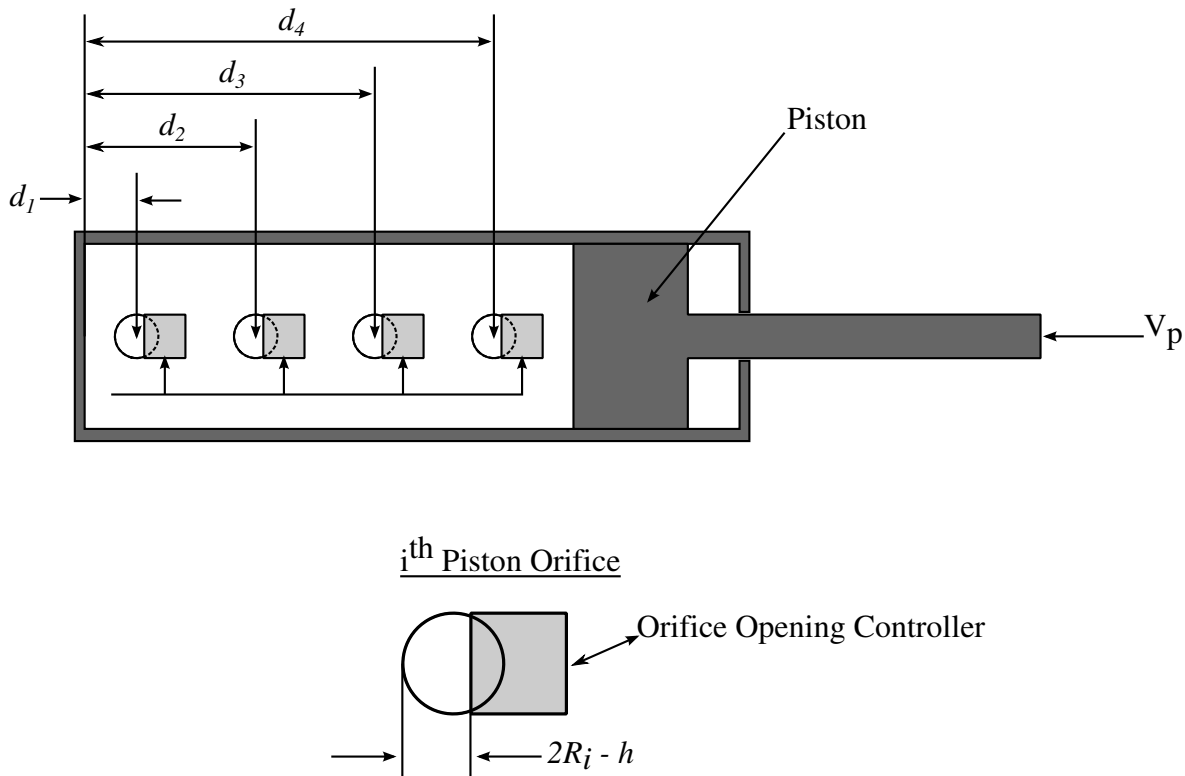

Figure 2-37. Mathematical model for the Side Impact Dummy damper.

In the implementation, the orifices are assumed to be circular with partial covering by the orifice controller. As the piston closes, the closure of the orifice is gradual. This gradual closure is properly taken into account to insure a smooth response. If the piston stroke is exceeded, the stiffness value, k, limits further movement, i.e., if the damper bottoms out in tension or compression the damper forces are calculated by replacing the damper by a bottoming out spring and damper, k and c, respectively. The piston stroke must exceed the initial length of the beam element. The time step calculation is based in part on the stiffness

value of the bottoming out spring. A typical force versus displacement curve at constant relative velocity is shown in [Figure 2-38](#).

The factor, SF, which scales the force defaults to 1.0 and is analogous to the adjusting ring on the damper.

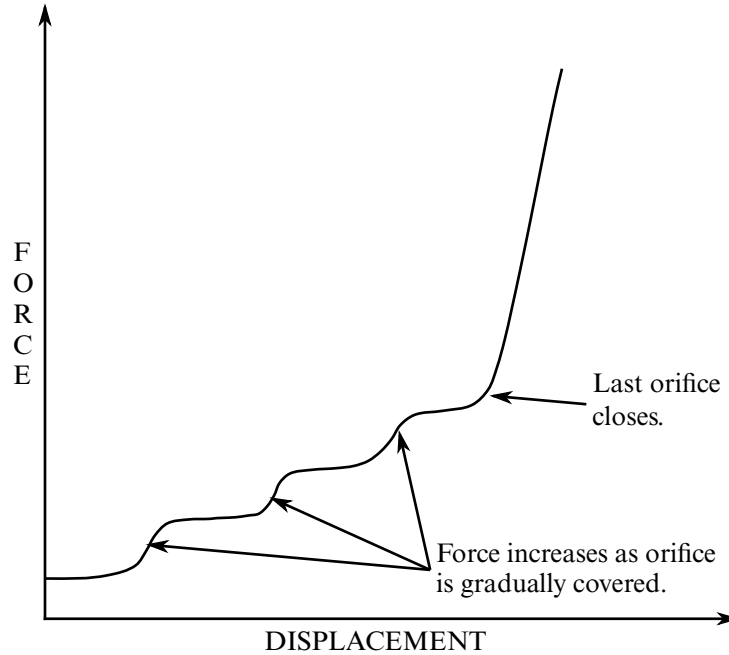

Figure 2-38. Force versus displacement as orifices are covered at a constant relative velocity. Only the linear velocity term is active.

***MAT_HYDRAULIC_GAS_DAMPER_DISCRETE_BEAM**

This is Material Type 70. This special purpose element represents a combined hydraulic and gas-filled damper which has a variable orifice coefficient. A schematic of the damper is shown in [Figure 2-39](#). Dampers of this type are sometimes used on buffers at the end of railroad tracks and as aircraft undercarriage shock absorbers. This material can be used only as a discrete beam element. See also notes below.

Card 1	1	2	3	4	5	6	7	8
Variable	MID	RO	CO	N	P0	PA	AP	KH
Type	A8	F	F	F	F	F	F	F

Card 2	1	2	3	4	5	6	7	8
Variable	LCID	FR	SCLF	CLEAR				
Type	F	F	F	F				

VARIABLE**DESCRIPTION**

MID	Material identification. A unique number or label not exceeding 8 characters must be specified.
RO	Mass density, see also volume in *SECTION_BEAM definition.
CO	Length of gas column, C_0
N	Adiabatic constant
P0	Initial gas pressure, P_0
PA	Atmospheric pressure, P_a
AP	Piston cross sectional area, A_p
KH	Hydraulic constant, K
LCID	Load curve ID, see *DEFINE_CURVE, defining the orifice area, a_0 , versus element deflection.

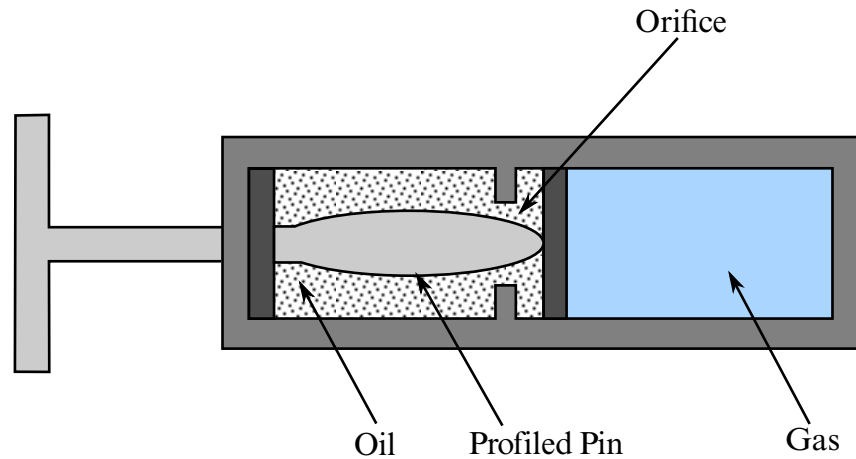

Figure 2-39. Schematic of Hydraulic/Gas damper.

VARIABLE	DESCRIPTION
FR	Return factor on orifice force. This acts as a factor on the hydraulic force only and is applied when unloading. It is intended to represent a valve that opens when the piston unloads to relieve hydraulic pressure. Set it to 1.0 for no such relief.
SCLF	Scale factor on force. (Default = 1.0)
CLEAR	Clearance (if nonzero, no tensile force develops for positive displacements and negative forces develop only after the clearance is closed).

Remarks:

As the damper is compressed two actions contribute to the force which develops. First, the gas is adiabatically compressed into a smaller volume. Secondly, oil is forced through an orifice. A profiled pin may occupy some of the cross-sectional area of the orifice; thus, the orifice area available for the oil varies with the stroke. The force is assumed proportional to the square of the velocity and inversely proportional to the available area.

The equation for this element is:

$$F = SCLF \times \left\{ K_h \left(\frac{V}{a_0} \right)^2 + \left[P_0 \left(\frac{C_0}{C_0 - S} \right)^n - P_a \right] A_p \right\}$$

where S is the element deflection and V is the relative velocity across the element.

***MAT_CABLE_DISCRETE_BEAM**

This is Material Type 71. This model permits elastic cables to be realistically modeled; thus, no force will develop in compression.

Card 1	1	2	3	4	5	6	7	8
Variable	MID	RO	E	LCID	F0	TMAXF0	TRAMP	IREAD
Type	A8	F	F	F	F	F	F	I
Default	none	none	none	none	0	0	0	0

Additional card for IREAD > 1.

Card 2	1	2	3	4	5	6	7	8
Variable	OUTPUT	TSTART	FRACLO	MXEPS	MXFRC			
Type	I	F	F	F	F			
Default	0	0	0	1.0E+20	1.0E+20			

VARIABLE**DESCRIPTION**

MID	Material identification. A unique number or label not exceeding 8 characters must be specified.
RO	Mass density, see also volume in *SECTION_BEAM definition.
E	GT.0.0: Young's modulus LT.0.0: Stiffness
LCID	Load curve ID, see *DEFINE_CURVE, defining the stress versus engineering strain. (Optional).
F0	Initial tensile force. If F0 is defined, an offset is not needed for an initial tensile force.
TMAXF0	Time for which pre-tension force will be held

VARIABLE	DESCRIPTION
TRAMP	Ramp-up time for pre-tension force
IREAD	Set to 1 to read second line of input
OUTPUT	Flag = 1 to output axial strain (see note)
TSTART	Time at which the ramp-up of pre-tension begins
FRACL0	Fraction of initial length that should be reached over time period of TRAMP. Corresponding tensile force builds up as necessary to reach cable length = FRACL0 × L0 at time t = TRAMP.
MXEPS	Maximum strain at failure
MXFRC	Maximum force at failure

Remarks:

The force, *F*, generated by the cable is nonzero if and only if the cable is tension. The force is given by:

$$F = \max(F_0 + K\Delta L, 0.)$$

where ΔL is the change in length

$$\Delta L = \text{current length} - (\text{initial length} - \text{offset})$$

and the stiffness ($E > 0.0$ only) is defined as:

$$K = \frac{E \times \text{area}}{(\text{initial length} - \text{offset})}$$

Note that a constant force element can be obtained by setting:

$$F_0 > 0 \text{ and } K = 0$$

although the application of such an element is unknown.

The area and offset are defined on either the cross section or element cards. For a slack cable the offset should be input as a negative length. For an initial tensile force the offset should be positive.

If a load curve is specified the Young’s modulus will be ignored and the load curve will be used instead. The points on the load curve are defined as engineering stress versus engineering strain, i.e., the change in length over the initial length. The unloading behavior follows the loading.

By default, cable pretension is applied only at the start of the analysis. If the cable is attached to flexible structure, deformation of the structure will result in relaxation of the cables, which will therefore lose some or all of the intended preload.

This can be overcome by using TMAXF0. In this case, it is expected that the structure will deform under the loading from the cables and that this deformation will take time to occur during the analysis. The unstressed length of the cable will be continuously adjusted until time TMAXF0 such that the force is maintained at the user-defined pre-tension force – this is analogous to operation of the pre-tensioning screws in real cables. After time TMAXF0, the unstressed length is fixed and the force in the cable is determined in the normal way using the stiffness and change of length.

Sudden application of the cable forces at time zero may result in an excessively dynamic response during pre-tensioning. A ramp-up time TRAMP may optionally be defined. The cable force ramps up from zero at time TSTART to the full pre-tension F0 at time TSTART + TRAMP. TMAXF0, if set less than TSTART + TRAMP by the user, will be internally reset to TSTART + TRAMP.

If the model does not use dynamic relaxation, it is recommended that damping be applied during pre-tensioning so that the structure reaches a steady state by time TMAXF0.

If the model uses dynamic relaxation, TSTART, TRAMP, and TMAXF0 apply only during dynamic relaxation. The cable preload at the end of dynamic relaxation carries over to the start of the subsequent transient analysis.

The cable mass will be calculated from length \times area \times density if VOL is set to zero on *SECTION_BEAM. Otherwise, VOL \times density will be used.

If OUTPUT is set in any cable material, extra variables will be written to the d3plot and d3thdt files for all beam elements. Post-processors should interpret the extra data as per Resultant beams. Only the first extra data item, axial strain, is computed for MAT_CABLE elements.

If the stress-strain load curve option, LCID, is combined with preload, two types of behavior are available:

1. If the preload is applied using the TMAXF0/TRAMP method, the initial strain is calculated from the stress-strain curve to achieve the desired preload.
2. If TMAXF0/TRAMP are not used, the preload force is taken as additional to the force calculated from the stress/strain curve. Thus, the total stress in the cable will be higher than indicated by the stress/strain curve.

***MAT_CONCRETE_DAMAGE**

This is Material Type 72. This model has been used to analyze buried steel reinforced concrete structures subjected to impulsive loadings. A newer version of this model is available as *MAT_CONCRETE_DAMAGE_REL3

Card 1	1	2	3	4	5	6	7	8
Variable	MID	R0	PR					
Type	A8	F	F					
Default	none	none	none					

Card 2	1	2	3	4	5	6	7	8
Variable	SIGF	A0	A1	A2				
Type	F	F	F	F				
Default	0.0	0.0	0.0	0.0				

Card 3	1	2	3	4	5	6	7	8
Variable	A0Y	A1Y	A2Y	A1F	A2F	B1	B2	B3
Type	F	F	F	F	F	F	F	F
Default	0.0	0.0	0.0	0.0	0.0	0.0	0.0	0.0

MAT_072**MAT_CONCRETE_DAMAGE**

Card 4	1	2	3	4	5	6	7	8
Variable	PER	ER	PRR	SIGY	ETAN	LCP	LCR	
Type	F	F	F	F	F	F	F	
Default	0.0	0.0	0.0	none	0.0	none	none	

Card 5	1	2	3	4	5	6	7	8
Variable	λ	$\lambda 2$	$\lambda 3$	$\lambda 4$	$\lambda 5$	$\lambda 6$	$\lambda 7$	$\lambda 8$
Type	F	F	F	F	F	F	F	F
Default	none	none	none	none	none	none	none	none

Card 6	1	2	3	4	5	6	7	8
Variable	$\lambda 9$	$\lambda 10$	$\lambda 11$	$\lambda 12$	$\lambda 13$			
Type	F	F	F	F	F			
Default	none	none	none	none	none			

Card 7	1	2	3	4	5	6	7	8
Variable	$\eta 1$	$\eta 2$	$\eta 3$	$\eta 4$	$\eta 5$	$\eta 6$	$\eta 7$	$\eta 8$
Type	F	F	F	F	F	F	F	F
Default	none	none	none	none	none	none	none	none

Card 8	1	2	3	4	5	6	7	8
Variable	η_9	η_{10}	η_{11}	η_{12}	η_{13}			
Type	F	F	F	F	F			
Default	none	none	none	none	none			

VARIABLE**DESCRIPTION**

MID	Material identification. A unique number or label not exceeding 8 characters must be specified.
RO	Mass density.
PR	Poisson's ratio.
SIGF	Maximum principal stress for failure.
A0	Cohesion.
A1	Pressure hardening coefficient.
A2	Pressure hardening coefficient.
A0Y	Cohesion for yield
A1Y	Pressure hardening coefficient for yield limit
A2Y	Pressure hardening coefficient for yield limit
A1F	Pressure hardening coefficient for failed material.
A2F	Pressure hardening coefficient for failed material.
B1	Damage scaling factor.
B2	Damage scaling factor for uniaxial tensile path.
B3	Damage scaling factor for triaxial tensile path.
PER	Percent reinforcement.
ER	Elastic modulus for reinforcement.

VARIABLE	DESCRIPTION
PRR	Poisson's ratio for reinforcement.
SIGY	Initial yield stress.
ETAN	Tangent modulus/plastic hardening modulus.
LCP	Load curve ID giving rate sensitivity for principal material, see *DEFINE_CURVE.
LCR	Load curve ID giving rate sensitivity for reinforcement, see *DEFINE_CURVE.
$\lambda_1 - \lambda_{13}$	Tabulated damage function
$\eta_1 - \eta_{13}$	Tabulated scale factor.

Remarks:

1. Cohesion for failed material $a_{0f} = 0$.
2. B3 must be positive or zero.
3. $\lambda_n \leq \lambda_{n+1}$. The first point must be zero.

*MAT_CONCRETE_DAMAGE_REL3

This is Material Type 72R3. The Karagozian & Case (K&C) Concrete Model - Release III is a three-invariant model, uses three shear failure surfaces, includes damage and strain-rate effects, and has origins based on the Pseudo-TENSOR Model (Material Type 16). The most significant user improvement provided by Release III is a model parameter generation capability, based solely on the unconfined compression strength of the concrete. The implementation of Release III significantly changed the user input, thus previous input files using Material Type 72, i.e. prior to LS-DYNA Version 971, are not compatible with the present input format.

An open source reference, that precedes the parameter generation capability, is provided in Malvar et al. [1997]. A workshop proceedings reference, Malvar et al. [1996], is useful, but may be difficult to obtain. More recent, but *limited distribution* reference materials, e.g. Malvar et al. [2000], may be obtained by contacting Karagozian & Case.

Seven card images are required to define the *complete* set of model parameters for the K&C Concrete Model. An Equation-of-State is also required for the pressure-volume strain response. Brief descriptions of all the input parameters are provided below, however it is expected that this model will be used primarily with the option to automatically generate the model parameters based on the unconfined compression strength of the concrete. These generated material parameters, along with the generated parameters for *EOS_TABULATED_COMPACTION, are written to the d3hsp file.

Card 1	1	2	3	4	5	6	7	8
Variable	MID	R0	PR					
Type	A8	F	F					
Default	none	none	none					

Card 2	1	2	3	4	5	6	7	8
Variable	FT	A0	A1	A2	B1	OMEGA	A1F	
Type	F	F	F	F	F	F	F	
Default	none	0.0	0.0	0.0	0.0	none	0.0	

Card 3	1	2	3	4	5	6	7	8
Variable	Sλ	NOUT	EDROP	RSIZE	UCF	LCRATE	LOCWID	NPTS
Type	F	F	F	F	F	I	F	F
Default	none	none	none	none	none	none	none	none

Card 4	1	2	3	4	5	6	7	8
Variable	λ01	λ02	λ03	λ04	λ05	λ06	λ07	λ08
Type	F	F	F	F	F	F	F	F
Default	none	none	none	none	none	none	none	none

Card 5	1	2	3	4	5	6	7	8
Variable	λ09	λ10	λ11	λ12	λ13	B3	A0Y	A1Y
Type	F	F	F	F	F	F	F	F
Default	none	none	none	none	none	none	0.0	0.0

Card 6	1	2	3	4	5	6	7	8
Variable	η01	η02	η03	η04	η05	η06	η07	η08
Type	F	F	F	F	F	F	F	F
Default	none	none	none	none	none	none	none	none

Card 7	1	2	3	4	5	6	7	8
Variable	η_{09}	η_{10}	η_{11}	η_{12}	η_{13}	B2	A2F	A2Y
Type	F	F	F	F	F	F	F	F
Default	none	none	none	none	none	0.0	0.0	0.0

VARIABLE**DESCRIPTION**

MID	Material identification. A unique number or label not exceeding 8 characters must be specified.
RO	Mass density.
PR	Poisson's ratio, ν .
FT	Uniaxial tensile strength, f_t .
A0	Maximum shear failure surface parameter, a_0 or $-f'_c$ for parameter generation (recommended).
A1	Maximum shear failure surface parameter, a_1 .
A2	Maximum shear failure surface parameter, a_2 .
B1	Compressive damage scaling parameter, b_1
OMEGA	Fractional dilatancy, ω .
A1F	Residual failure surface coefficient, a_{1f} .
S λ	λ stretch factor, s .
NOUT	Output selector for effective plastic strain (see table).
EDROP	Post peak dilatancy decay, N^α .
RSIZE	Unit conversion factor for length (inches/user-unit), e.g. 39.37 if user length unit in meters.
UCF	Unit conversion factor for stress (psi/user-unit), e.g. 145 if f'_c in MPa.

VARIABLE	DESCRIPTION
LCRATE	Define (load) curve number for strain-rate effects; effective strain rate on abscissa (negative = tension) and strength enhancement on ordinate.
LOCWID	Three times the maximum aggregate diameter (input in user length units).
NPTS	Number of points in λ versus η damage relation; must be 13 points.
$\lambda 01$	1 st value of damage function, (a.k.a., 1 st value of "modified" effective plastic strain; see references for details).
$\lambda 02$	2 nd value of damage function,
$\lambda 03$	3 rd value of damage function,
$\lambda 04$	4 th value of damage function,
$\lambda 05$	5 th value of damage function,
$\lambda 06$	6 th value of damage function,
$\lambda 07$	7 th value of damage function,
$\lambda 08$	8 th value of damage function,
$\lambda 09$	9 th value of damage function,
$\lambda 10$	10 th value of damage function,
$\lambda 11$	11 th value of damage function,
$\lambda 12$	12 th value of damage function,
$\lambda 13$	13 th value of damage function.
B3	Damage scaling coefficient for triaxial tension, b_3 .
A0Y	Initial yield surface cohesion, a_{0y} .
A1Y	Initial yield surface coefficient, a_{1y} .
$\eta 01$	1 st value of scale factor,
$\eta 02$	2 nd value of scale factor,
$\eta 03$	3 rd value of scale factor,

VARIABLE	DESCRIPTION
$\eta04$	4 th value of scale factor,
$\eta05$	5 th value of scale factor,
$\eta06$	6 th value of scale factor,
$\eta07$	7 th value of scale factor,
$\eta08$	8 th value of scale factor,
$\eta09$	9 th value of scale factor,
$\eta10$	10 th value of scale factor,
$\eta11$	11 th value of scale factor,
$\eta12$	12 th value of scale factor,
$\eta13$	13 th value of scale factor.
B2	Tensile damage scaling exponent, b_2 .
A2F	Residual failure surface coefficient, a_{2f} .
A2Y	Initial yield surface coefficient, a_{2y} .

λ , sometimes referred to as “modified” effective plastic strain, is computed internally as a function of effective plastic strain, strain rate enhancement factor, and pressure. η is a function of λ as specified by the η vs. λ curve. The η value, which is always between 0 and 1, is used to interpolate between the yield failure surface and the maximum failure surface, or between the maximum failure surface and the residual failure surface, depending on whether λ is to the left or right of the first peak in the the η vs. λ curve. The “scaled damage measure” ranges from 0 to 1 as the material transitions from the yield failure surface to the maximum failure surface, and thereafter ranges from 1 to 2 as the material ranges from the maximum failure surface to the residual failure surface. See the references for details.

Output of Selected Variables:

The quantity labeled as “plastic strain” by LS-PrePost is actually the quantity described in [Table 2-40](#), in accordance with the input value of NOUT (see Card 3 above).

NOUT	Function	Description
1		Current shear failure surface radius
2	$\delta = 2\lambda / (\lambda + \lambda_m)$	Scaled damage measure
3	$\dot{\sigma}_{ij} \dot{\epsilon}_{ij}$	Strain energy (rate)
4	$\dot{\sigma}_{ij} \dot{\epsilon}_{ij}^p$	Plastic strain energy (rate)

Table 2-40. Description of quantity labeled “plastic strain” by LS-PrePost.

An additional six extra history variables as shown in [Table 2-41](#) may be written by setting NEIPH = 6 on the keyword *DATABASE_EXTENT_BINARY. The extra history variables are labeled as "history var#1" through "history var#6" in LS-PrePost.

Label	Description
history var#1	Internal energy
history var#2	Pressure from bulk viscosity
history var#3	Volume in previous time step
history var#4	Plastic volumetric strain
history var#5	Slope of damage evolution (η vs. λ) curve
history var#6	“Modified” effective plastic strain (λ)

Table 2-41. Extra History Variables for *MAT_072R3

Sample Input for Concrete:

As an example of the K&C Concrete Model material parameter generation, the following sample input for a 45.4 MPa (6,580 psi) unconfined compression strength concrete is provided. The basic units for the provided parameters are length in millimeters (mm), time in milliseconds (msec), and mass in grams (g). This base unit set yields units of force in Newtons (N) and pressure in Mega-Pascals (MPa).

Card 1	1	2	3	4	5	6	7	8
Variable	MID	R0	PR					
Type	72	2.3E-3						

Card 2	1	2	3	4	5	6	7	8
Variable	FT	A0	A1	A2	B1	OMEGA	A1F	
Type		-45.4						

Card 3	1	2	3	4	5	6	7	8
Variable	Sλ	NOUT	EDROP	RSIZE	UCF	LCRATE	LOCWID	NPTS
Type				3.94E-2	145.0	723.0		

Card 4	1	2	3	4	5	6	7	8
Variable	λ01	λ02	λ03	λ04	λ05	λ06	λ07	λ08
Type								

Card 5	1	2	3	4	5	6	7	8
Variable	λ09	λ10	λ11	λ12	λ13	B3	A0Y	A1Y
Type								

Card 6	1	2	3	4	5	6	7	8
Variable	η01	η02	η03	η04	η05	η06	η07	η08
Type								

Card 7	1	2	3	4	5	6	7	8
Variable	η_{09}	η_{10}	η_{11}	η_{12}	η_{13}	B2	A2F	A2Y
Type								

Shear strength enhancement factor versus effective strain rate is given by a curve (*DEFINE_CURVE) with LCID 723. The sample input values, see Malvar & Ross [1998], are given in [Table 2-42](#).

Strain-Rate (1/ms)	Enhancement
-3.0E+01	9.70
-3.0E-01	9.70
-1.0E-01	6.72
-3.0E-02	4.50
-1.0E-02	3.12
-3.0E-03	2.09
-1.0E-03	1.45
-1.0E-04	1.36
-1.0E-05	1.28
-1.0E-06	1.20
-1.0E-07	1.13
-1.0E-08	1.06
0.0E+00	1.00
3.0E-08	1.00
1.0E-07	1.03
1.0E-06	1.08
1.0E-05	1.14
1.0E-04	1.20
1.0E-03	1.26
3.0E-03	1.29
1.0E-02	1.33
3.0E-02	1.36
1.0E-01	2.04
3.0E-01	2.94
3.0E+01	2.94

Table 2-42. Enhancement versus effective strain rate for 45.4 MPa concrete (sample). When defining curve LCRATE, input negative (tensile) values of effective strain rate first. The enhancement should be positive and should be 1.0 at a strain rate of zero.

***MAT_LOW_DENSITY_VISCOUS_FOAM**

This is Material Type 73 for Modeling Low Density Urethane Foam with high compressibility and with rate sensitivity which can be characterized by a relaxation curve. Its main applications are for seat cushions, padding on the Side Impact Dummies (SID), bumpers, and interior foams. Optionally, a tension cut-off failure can be defined. Also, see the notes below and the description of material 57: *MAT_LOW_DENSITY_FOAM.

Card 1	1	2	3	4	5	6	7	8
Variable	MID	RO	E	LCID	TC	HU	BETA	DAMP
Type	A8	F	F	F	F	F	F	F
Default					1.E+20	1.		
Remarks						3	1	

Card 2	1	2	3	4	5	6	7	8
Variable	SHAPE	FAIL	BVFLAG	KCON	LCID2	BSTART	TRAMP	NV
Type	F	F	F	F	F	F	F	I
Default	1.0	0.0	0.0	0.0	0	0.0	0.0	6

Relaxation Constant Cards. If LCID2 = 0 then include the following viscoelastic constants. Up to 6 cards may be input. A keyword card (with a "*" in column 1) terminates this input if less than 6 cards are used.

Card 3	1	2	3	4	5	6	7	8
Variable	GI	BETA1	REF					
Type	F	F	F					

Frequency Dependence Card. If LCID2 = -1 then include the following frequency dependent viscoelastic data.

Card 4	1	2	3	4	5	6	7	8
Variable	LCID3	LCID4	SCALEW	SCALEA				
Type	I	I	I	I				

VARIABLE	DESCRIPTION
MID	Material identification. A unique number or label not exceeding 8 characters must be specified.
RO	Mass density
E	Young’s modulus used in tension. For implicit problems E is set to the initial slope of load curve LCID.
LCID	Load curve ID, see *DEFINE_CURVE, for nominal stress versus strain.
TC	Tension cut-off stress
HU	Hysteretic unloading factor between 0 and 1 (default = 1, i.e., no energy dissipation), see also Figure 2-31
BETA	β , decay constant to model creep in unloading. EQ.0.0: No relaxation.
DAMP	Viscous coefficient (.05 < recommended value <.50) to model damping effects. LT.0.0: DAMP is the load curve ID, which defines the damping constant as a function of the maximum strain in compression defined as: $\epsilon_{max} = \max(1 - \lambda_1, 1 - \lambda_2, 1 - \lambda_3)$ In tension, the damping constant is set to the value corresponding to the strain at 0. The abscissa should be defined from 0 to 1.
SHAPE	Shape factor for unloading. Active for nonzero values of the hysteretic unloading factor. Values less than one reduces the energy dissipation and greater than one increases dissipation, see also Figure 2-31 .

VARIABLE	DESCRIPTION
FAIL	Failure option after cutoff stress is reached: EQ.0.0: tensile stress remains at cut-off value, EQ.1.0: tensile stress is reset to zero.
BVFLAG	Bulk viscosity activation flag, see remark below: EQ.0.0: no bulk viscosity (recommended), EQ.1.0: bulk viscosity active.
KCON	Stiffness coefficient for contact interface stiffness. Maximum slope in stress vs. strain curve is used. When the maximum slope is taken for the contact, the time step size for this material is reduced for stability. In some cases Δt may be significantly smaller, and defining a reasonable stiffness is recommended.
LCID2	Load curve ID of relaxation curve. If constants β_i are determined via a least squares fit. This relaxation curve is shown in Figure 2-44 . This model ignores the constant stress.
BSTART	Fit parameter. In the fit, β_1 is set to zero, β_2 is set to BSTART, β_3 is 10 times β_2 , β_4 is 10 times greater than β_3 , and so on. If zero, BSTART = .01.
TRAMP	Optional ramp time for loading.
NV	Number of terms in fit. If zero, the default is 6. Currently, the maximum number is set to 6. Values of 2 or 3 are recommended, since each term used adds significantly to the cost. Caution should be exercised when taking the results from the fit. Preferably, all generated coefficients should be positive. Negative values may lead to unstable results. Once a satisfactory fit has been achieved it is recommended that the coefficients which are written into the output file be input in future runs.
GI	Optional shear relaxation modulus for the i th term
BETAI	Optional decay constant if i th term

VARIABLE	DESCRIPTION
REF	Use reference geometry to initialize the stress tensor. The reference geometry is defined by the keyword:*INITIAL_FOAM_REFERENCE_GEOMETRY (see there for more details). EQ.0.0: off, EQ.1.0: on.
LCID3	Load curve ID giving the magnitude of the shear modulus as a function of the frequency. LCID3 must use the same frequencies as LCID4.
LCID4	Load curve ID giving the phase angle of the shear modulus as a function of the frequency. LCID4 must use the same frequencies as LCID3.
SCALEW	Flag for the form of the frequency data. EQ.0.0: Frequency is in cycles per unit time. EQ.1.0: Circular frequency.
SCALEA	Flag for the units of the phase angle. EQ.0.0: Degrees. EQ.1.0: Radians.

Material Formulation:

This viscoelastic foam model is available to model highly compressible viscous foams. The hyperelastic formulation of this model follows that of Material 57.

Rate effects are accounted for through linear viscoelasticity by a convolution integral of the form

$$\sigma_{ij}^r = \int_0^t g_{ijkl}(t - \tau) \frac{\partial \varepsilon_{kl}}{\partial \tau} d\tau$$

where $g_{ijkl}(t - \tau)$ is the relaxation function. The stress tensor, σ_{ij}^r , augments the stresses determined from the foam, σ_{ij}^f ; consequently, the final stress, σ_{ij} , is taken as the summation of the two contributions:

$$\sigma_{ij} = \sigma_{ij}^f + \sigma_{ij}^r.$$

Since we wish to include only simple rate effects, the relaxation function is represented by up to six terms of the Prony series:

$$g(t) = \alpha_0 + \sum_{m=1}^N \alpha_m e^{-\beta t}$$

This model is effectively a Maxwell fluid which consists of a dampers and springs in series. The formulation is performed in the local system of principal stretches where only the principal values of stress are computed and triaxial coupling is avoided. Consequently, the one-dimensional nature of this foam material is unaffected by this addition of rate effects. The addition of rate effects necessitates 42 additional history variables per integration point. The cost and memory overhead of this model comes primarily from the need to “remember” the local system of principal stretches and the evaluation of the viscous stress components.

Frequency data can be fit to the Prony series. Using Fourier transforms the relationship between the relaxation function and the frequency dependent data is

$$G_s(\omega) = \alpha_0 + \sum_{m=1}^N \frac{\alpha_m (\omega/\beta_m)^2}{1 + (\omega/\beta_m)^2}$$

$$G_l(\omega) = \sum_{m=1}^N \frac{\alpha_m \omega/\beta_m}{1 + \omega/\beta_m}$$

where the storage modulus and loss modulus are defined in terms of the frequency dependent magnitude G and phase angle ϕ given by load curves LCID3 and LCID4 respectively,

$$G_s(\omega) = G(\omega) \cos[\phi(\omega)] , \text{ and}$$

$$G_l(\omega) = G(\omega) \sin[\phi(\omega)]$$

Remarks:

When hysteretic unloading is used the reloading will follow the unloading curve if the decay constant, β , is set to zero. If β is nonzero the decay to the original loading curve is governed by the expression:

$$1 - e^{-\beta t}$$

The bulk viscosity, which generates a rate dependent pressure, may cause an unexpected volumetric response and, consequently, it is optional with this model.

The hysteretic unloading factor results in the unloading curve to lie beneath the loading curve as shown in [Figure 2-31](#). This unloading provides energy dissipation which is reasonable in certain kinds of foam.

*MAT_ELASTIC_SPRING_DISCRETE_BEAM

This is Material Type 74. This model permits elastic springs with damping to be combined and represented with a discrete beam element type 6. Linear stiffness and damping coefficients can be defined, and, for nonlinear behavior, a force versus deflection and force versus rate curves can be used. Displacement based failure and an initial force are optional.

Card 1	1	2	3	4	5	6	7	8
Variable	MID	RO	K	F0	D	CDF	TDF	
Type	A8	F	F	F	F	F	F	

Card 2	1	2	3	4	5	6	7	8
Variable	FLCID	HLCID	C1	C2	DLE	GLCID		
Type	F	F	F	F	F	I		

<u>VARIABLE</u>	<u>DESCRIPTION</u>
MID	Material identification. A unique number or label not exceeding 8 characters must be specified.
RO	Mass density, see also volume in *SECTION_BEAM definition.
K	Stiffness coefficient.
F0	Optional initial force. This option is inactive if this material is referenced in a part referenced by material type *MAT_ELASTIC_6DOF_SPRING
D	Viscous damping coefficient.
CDF	Compressive displacement at failure. Input as a positive number. After failure, no forces are carried. This option does not apply to zero length springs. EQ.0.0: inactive.
TDF	Tensile displacement at failure. After failure, no forces are carried.

VARIABLE	DESCRIPTION
FLCID	Load curve ID, see *DEFINE_CURVE, defining force versus deflection for nonlinear behavior.
HLCID	Load curve ID, see *DEFINE_CURVE, defining force versus relative velocity for nonlinear behavior (optional). If the origin of the curve is at (0,0) the force magnitude is identical for a given magnitude of the relative velocity, i.e., only the sign changes.
C1	Damping coefficient for nonlinear behavior (optional).
C2	Damping coefficient for nonlinear behavior (optional).
DLE	Factor to scale time units. The default is unity.
GLCID	Optional load curve ID, see *DEFINE_CURVE, defining a scale factor versus deflection for load curve ID, HLCID. If zero, a scale factor of unity is assumed.

Remarks:

If the linear spring stiffness is used, the force, F , is given by:

$$F = F_0 + K\Delta L + D\Delta\dot{L}$$

but if the load curve ID is specified, the force is then given by:

$$F = F_0 + Kf(\Delta L) \left\{ 1 + C1 \times \Delta\dot{L} + C2 \times \text{sgn}(\Delta\dot{L}) \ln \left[\max \left(1, \frac{\Delta\dot{L}}{DLE} \right) \right] \right\} + D\Delta\dot{L} + g(\Delta L)h(\Delta\dot{L})$$

In these equations, ΔL is the change in length

$$\Delta L = \text{current length} - \text{initial length}$$

The cross sectional area is defined on the section card for the discrete beam elements, See *SECTION_BEAM. The square root of this area is used as the contact thickness offset if these elements are included in the contact treatment.

*MAT_BILKHU/DUBOIS_FOAM

This is Material Type 75. This model is for the simulation of isotropic crushable foams. Uniaxial and triaxial test data are used to describe the behavior.

Card 1	1	2	3	4	5	6	7	8
Variable	MID	RO	YM	LCPY	LCUYS	VC	PC	VPC
Type	A8	F	F	F	F	F	F	F

Card 2	1	2	3	4	5	6	7	8
Variable	TSC	VTSC	LCRATE	PR	KCON	ISFLG		
Type	I	F	F	F	F	F		

VARIABLE	DESCRIPTION
MID	Material identification. A unique number or label not exceeding 8 characters must be specified.
RO	Mass density
YM	Young's modulus (E)
LCPY	Load curve ID giving pressure for plastic yielding versus volumetric strain, see Figure 2-43 .
LCUYS	Load curve ID giving uniaxial yield stress versus volumetric strain, see Figure 2-43 , all abscissa should be positive if only the results of a compression test are included, optionally the results of a tensile test can be added (corresponding to negative values of the volumetric strain), in the latter case PC, VPC, TC and VTC will be ignored
VC	Viscous damping coefficient (.05 < recommended value < .50).
PC	Pressure cutoff. If zero, the default is set to one-tenth of p_0 , the yield pressure corresponding to a volumetric strain of zero.
VPC	Variable pressure cutoff as a fraction of pressure yield value. If non-zero this will override the pressure cutoff value PC.

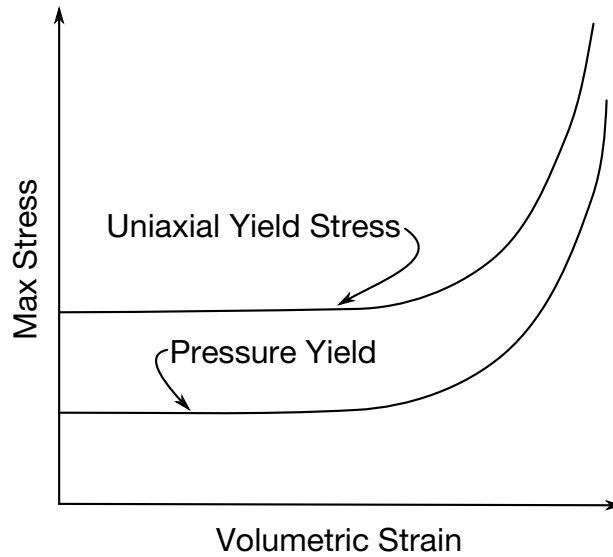

Figure 2-43. Behavior of crushable foam. Unloading is elastic.

VARIABLE	DESCRIPTION
TC	Tension cutoff for uniaxial tensile stress. Default is zero. A nonzero value is recommended for better stability.
VTC	Variable tension cutoff as a fraction of the uniaxial compressive yield strength, if non-zero this will override the tension cutoff value TC.
LCRATE	Load curve ID giving a scale factor for the previous yield curves, dependent upon the volumetric plastic strain.
PR	Poisson coefficient, which applies to both elastic and plastic deformations, must be smaller than 0.5
KCON	Stiffness coefficient for contact interface stiffness. If undefined one-third of Young's modulus, YM, is used. KCON is also considered in the element time step calculation; therefore, large values may reduce the element time step size.
ISFLG	Flag for tensile response (active only if negative abscissa are present in load curve LCUYS) EQ.0: load curve abscissa in tensile region correspond to volumetric strain EQ.1: load curve abscissa in tensile region correspond to effective strain

Remarks:

The logarithmic volumetric strain is defined in terms of the relative volume, V , as:

$$\gamma = -\ln(V)$$

If used (ISFLG-1), the effective strain is defined in the usual way:

$$\epsilon_{\text{eff}} = \sqrt{\frac{2}{3} \text{tr}(\epsilon^t \epsilon)}$$

In defining the load curve LCPY the stress and strain pairs should be positive values starting with a volumetric strain value of zero.

The load curve LCUYS can optionally contain the results of the tensile test (corresponding to negative values of the volumetric strain), if so, then the load curve information will override PC, VPC, TC and VTC

The yield surface is defined as an ellipse in the equivalent pressure and von Mises stress plane.

***MAT_GENERAL_VISCOELASTIC_{OPTION}**

The available options include:

<BLANK>

MOISTURE

This is Material Type 76. This material model provides a general viscoelastic Maxwell model having up to 18 terms in the prony series expansion and is useful for modeling dense continuum rubbers and solid explosives. Either the coefficients of the prony series expansion or a relaxation curve may be specified to define the viscoelastic deviatoric and bulk behavior.

The material model can also be used with laminated shell. Either an elastic or viscoelastic layer can be defined with the laminated formulation. To activate laminated shell you need the laminated formulation flag on *CONTROL_SHELL. With the laminated option a user defined integration rule is needed.

Card 1	1	2	3	4	5	6	7	8
Variable	MID	RO	BULK	PCF	EF	TREF	A	B
Type	A8	F	F	F	F	F	F	F

Relaxation Curve Card. Leave blank if the *Prony Series Cards* are used below. Also, leave blank if an elastic layer is defined in a laminated shell.

Card 2	1	2	3	4	5	6	7	8
Variable	LCID	NT	BSTART	TRAMP	LCIDK	NTK	BSTARTK	TRAMPK
Type	F	I	F	F	F	I	F	F

Moisture Card. Additional card for MOISTURE keyword option.

Card 3	1	2	3	4	5	6	7	8
Variable	MO	ALPHA	BETA	GAMMA	M			
Type	F	F	F	F	F			

Prony Series cards. Card Format for viscoelastic constants. Up to 18 cards may be input. A keyword card (with a "*" in column 1) terminates this input if less than 18 cards are used. These cards are not needed if relaxation data is defined. The number of terms for the shear behavior may differ from that for the bulk behavior: insert zero if a term is not included. If an elastic layer is defined you only need to define GI and KI (note in an elastic layer only one card is needed)

Card 4	1	2	3	4	5	6	7	8
Variable	GI	BETAI	KI	BETAKI				
Type	F	F	F	F				

VARIABLE	DESCRIPTION
MID	Material identification. A unique number or label not exceeding 8 characters must be specified.
RO	Mass density.
BULK	Elastic bulk modulus.
PCF	Tensile pressure elimination flag for solid elements only. If set to unity tensile pressures are set to zero.
EF	Elastic flag (if equal 1, the layer is elastic. If 0 the layer is viscoelastic).
TREF	Reference temperature for shift function (must be greater than zero).
A	Coefficient for the Arrhenius and the Williams-Landau-Ferry shift functions.
B	Coefficient for the Williams-Landau-Ferry shift function.
LCID	Load curve ID for deviatoric behavior if constants, G_i , and β_i are determined via a least squares fit. See Figure 2-44 for an example relaxation curve.
NT	Number of terms in shear fit. If zero the default is 6. Fewer than NT terms will be used if the fit produces one or more negative shear moduli. Currently, the maximum number is set to 18.

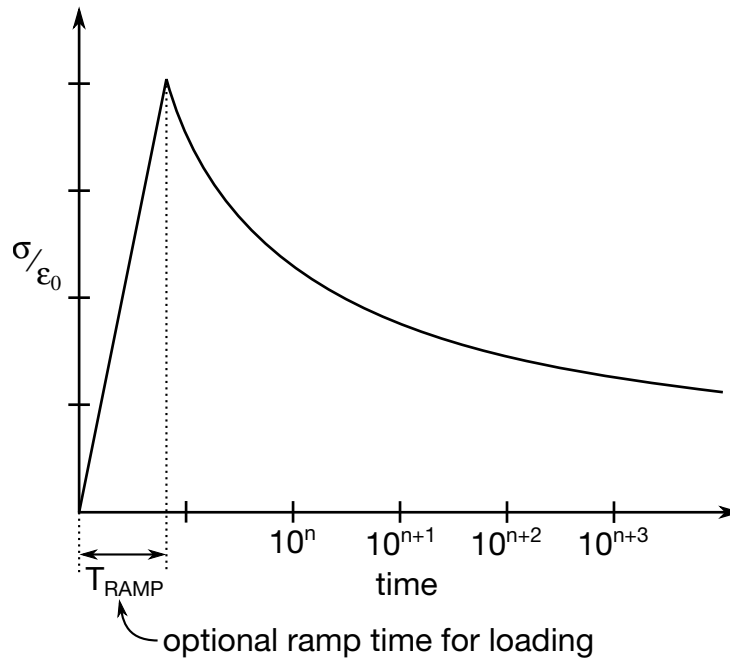

Figure 2-44. Relaxation curve. This curve defines stress versus time where time is defined on a logarithmic scale. For best results, the points defined in the load curve should be equally spaced on the logarithmic scale. Note the values for the abscissa are input as time, not log(time). Furthermore, the load curve should be smooth and defined in the positive quadrant. If nonphysical values are determined by least squares fit, LS-DYNA will terminate with an error message after the initialization phase is completed. If the ramp time for loading is included, then the relaxation which occurs during the loading phase is taken into account. This effect may or may not be important.

VARIABLE	DESCRIPTION
BSTART	In the fit, β_1 is set to zero, β_2 is set to BSTART, β_3 is 10 times β_2 , β_4 is 10 times β_3 , and so on. If zero, BSTART is determined by an iterative trial and error scheme.
TRAMP	Optional ramp time for loading.
LCIDK	Load curve ID for bulk behavior for constants, K_i , and β_{ki} are determined via a least squares fit. See Figure 2-44 for an example relaxation curve.
NTK	Number of terms desired in bulk fit. If zero the default is 6. Currently, the maximum number is set to 18.
BSTARTK	In the fit, β_{k1} is set to zero, β_{k2} is set to BSTARTK, β_{k3} is 10 times β_{k2} , β_{k4} is 100 times greater than β_{k3} , and so on. If zero, BSTARTK is determined by an iterative trial and error scheme.

VARIABLE	DESCRIPTION
TRAMPK	Optional ramp time for bulk loading.
MST	Moisture, M . If the moisture is 0.0, the moisture option is disabled. GT.0.0: Specifies a curve ID to make moisture a function of time. LT.0.0: Specifies the negative of a constant value of moisture.
MO	Initial moisture, M_0 . Defaults to zero.
ALPHA	Specifies α as a function of moisture. GT.0.0: Specifies a curve ID. LT.0.0: Specifies the negative of a constant value.
BETA	Specifies β as a function of moisture. GT.0.0: Specifies a curve ID. LT.0.0: Specifies the negative of a constant value.
GAMMA	Specifies γ as a function of moisture. GT.0.0: Specifies a curve ID. LT.0.0: Specifies the negative of a constant value.
GI	Optional shear relaxation modulus for the i^{th} term
BETAI	Optional shear decay constant for the i^{th} term
KI	Optional bulk relaxation modulus for the i^{th} term
BETAKI	Optional bulk decay constant for the i^{th} term

Remarks:

Rate effects are taken into account through linear viscoelasticity by a convolution integral of the form:

$$\sigma_{ij} = \int_0^t g_{ijkl}(t - \tau) \frac{\partial \varepsilon_{kl}}{\partial \tau} d\tau$$

where $g_{ijkl}(t - \tau)$ is the relaxation functions for the different stress measures. This stress is added to the stress tensor determined from the strain energy functional.

If we wish to include only simple rate effects, the relaxation function is represented by 18 terms from the Prony series:

$$g(t) = \sum_{m=1}^N G_m e^{-\beta_m t}$$

We characterize this in the input by shear moduli, G_i , and decay constants, β_i . An arbitrary number of terms, up to 18, may be used when applying the viscoelastic model.

For volumetric relaxation, the relaxation function is also represented by the Prony series in terms of bulk moduli:

$$k(t) = \sum_{m=1}^N K_m e^{-\beta_{k_m} t}$$

The Arrhenius and Williams-Landau-Ferry (WLF) shift functions account for the effects of the temperature on the stress relaxation. A scaled time, t' ,

$$t' = \int_0^t \Phi(T) dt$$

is used in the relaxation function instead of the physical time. The Arrhenius shift function is

$$\Phi(T) = \exp \left[-A \left(\frac{1}{T} - \frac{1}{T_{\text{REF}}} \right) \right]$$

and the Williams-Landau-Ferry shift function is

$$\Phi(T) = \exp \left(-A \frac{T - T_{\text{REF}}}{B + T - T_{\text{REF}}} \right)$$

If all three values (T_{REF} , A , and B) are not zero, the WLF function is used; the Arrhenius function is used if B is zero; and no scaling is applied if all three values are zero.

The moisture model allows the scaling of the material properties as a function of the moisture content of the material. The shear and bulk moduli are scaled by α , the decay constants are scaled by β , and a moisture strain, $\gamma(M)[M - M_O]$ is introduced analogous to the thermal strain.

*MAT_HYPERELASTIC_RUBBER

This is Material Type 77. This material model provides a general hyperelastic rubber model combined optionally with linear viscoelasticity as outlined by Christensen [1980].

Card 1	1	2	3	4	5	6	7	8
Variable	MID	RO	PR	N	NV	G	SIGF	REF
Type	A8	F	F	I	I	F	F	F

Hysteresis Card. Additional card read in when PR < 0 (Mullins Effect).

Card 2	1	2	3	4	5	6	7	8
Variable	TBHYS							
Type	F							

Card 3 for N > 0. For N > 0 a least squares fit is computed from uniaxial data.

Card 3	1	2	3	4	5	6	7	8
Variable	SGL	SW	ST	LCID1	DATA	LCID2	BSTART	TRAMP
Type	F	F	F	F	F	F	F	F

Card 3 for N = 0. Set the material parameters directly.

Card 3	1	2	3	4	5	6	7	8
Variable	C10	C01	C11	C20	C02	C30		
Type	F	F	F	F	F	F		

Optional Viscoelastic Constants & Frictional Damping Constant Cards. Up to 12 cards may be input. A keyword card (with a "*" in column 1) terminates this input if less than 12 cards are used.

Card 4	1	2	3	4	5	6	7	8
Variable	GI	BETAI	GJ	SIGFJ				
Type	F	F	F	F				

VARIABLE	DESCRIPTION
MID	Material identification. A unique number or label not exceeding 8 characters must be specified.
RO	Mass density
PR	Poisson's ratio (> .49 is recommended, smaller values may not work and should not be used). If this is set to a negative number, then the absolute value is used and an extra card is read for Mullins effect.
TBHYS	Table ID for hysteresis, see Remarks
N	Number of constants to solve for: EQ.1: Solve for C10 and C01 EQ.2: Solve for C10, C01, C11, C20, and C02 EQ.3: Solve for C10, C01, C11, C20, C02, and C30
NV	Number of Prony series terms in fit. If zero, the default is 6. Currently, the maximum number is set to 12. Values less than 12, possibly 3-5 are recommended, since each term used adds significantly to the cost. Caution should be exercised when taking the results from the fit. Preferably, all generated coefficients should be positive. Negative values may lead to unstable results. Once a satisfactory fit has been achieved it is recommended that the coefficients which are written into the output file be input in future runs.
G	Shear modulus for frequency independent damping. Frequency independent damping is based of a spring and slider in series. The critical stress for the slider mechanism is SIGF defined below. For the best results, the value of G should be 250-1000 times greater than SIGF.
SIGF	Limit stress for frequency independent frictional damping.

VARIABLE	DESCRIPTION
REF	Use reference geometry to initialize the stress tensor. The reference geometry is defined by the keyword:*INITIAL_FOAM_REFERENCE_GEOMETRY (see there for more details). EQ.0.0: off, EQ.1.0: on.

If N > 0 test information from a uniaxial test are used.

SGL	Specimen gauge length
SW	Specimen width
ST	Specimen thickness
LCID1	Load curve ID giving the force versus actual change in the gauge length
DATA	Type of experimental data. EQ.0.0: uniaxial data (Only option for this model)
LCID2	Load curve ID of relaxation curve If constants β_i are determined via a least squares fit. This relaxation curve is shown in Figure 2-44 . This model ignores the constant stress.
BSTART	In the fit, β_1 is set to zero, β_2 is set to BSTART, β_3 is 10 times β_2 , β_4 is 10 times β_3 , and so on. If zero, BSTART is determined by an iterative trial and error scheme.
TRAMP	Optional ramp time for loading.

If N = 0, the following constants have to be defined:

C10	C ₁₀
C01	C ₀₁
C11	C ₁₁
C20	C ₂₀
C02	C ₀₂
C30	C ₃₀

VARIABLE	DESCRIPTION
GI	Optional shear relaxation modulus for the ith term
BETAI	Optional decay constant if ith term
GJ	Optional shear modulus for frequency independent damping represented as the jth spring and slider in series in parallel to the rest of the stress contributions.
SIGFJ	Limit stress for frequency independent, frictional, damping represented as the jth spring and slider in series in parallel to the rest of the stress contributions.

Remarks:

Rubber is generally considered to be fully incompressible since the bulk modulus greatly exceeds the shear modulus in magnitude. To model the rubber as an unconstrained material a hydrostatic work term, $W_H(J)$, is included in the strain energy functional which is function of the relative volume, J , [Ogden 1984]:

$$W(J_1, J_2, J) = \sum_{p,q=0}^n C_{pq} (J_1 - 3)^p (J_2 - 3)^q + W_H(J)$$

$$J_1 = I_1 I_3^{-1/3}$$

$$J_2 = I_2 I_3^{-2/3}$$

In order to prevent volumetric work from contributing to the hydrostatic work the first and second invariants are modified as shown. This procedure is described in more detail by Sussman and Bathe [1987].

Rate effects are taken into account through linear viscoelasticity by a convolution integral of the form:

$$\sigma_{ij} = \int_0^t g_{ijkl}(t - \tau) \frac{\partial \varepsilon_{kl}}{\partial \tau} d\tau$$

or in terms of the second Piola-Kirchhoff stress, S_{ij} , and Green's strain tensor, E_{ij} ,

$$S_{ij} = \int_0^t G_{ijkl}(t - \tau) \frac{\partial E_{kl}}{\partial \tau} d\tau$$

where $g_{ijkl}(t - \tau)$ and $G_{ijkl}(t - \tau)$ are the relaxation functions for the different stress measures. This stress is added to the stress tensor determined from the strain energy functional.

If we wish to include only simple rate effects, the relaxation function is represented by six terms from the Prony series:

$$g(t) = \alpha_0 + \sum_{m=1}^N \alpha_m e^{-\beta t}$$

given by,

$$g(t) = \sum_{i=1}^n G_i e^{-\beta_i t}$$

This model is effectively a Maxwell fluid which consists of a dampers and springs in series. We characterize this in the input by shear moduli, G_i , and decay constants, β_i . The viscoelastic behavior is optional and an arbitrary number of terms may be used.

The Mooney-Rivlin rubber model (model 27) is obtained by specifying $n = 1$. In spite of the differences in formulations with Model 27, we find that the results obtained with this model are nearly identical with those of Material 27 as long as large values of Poisson's ratio are used.

The frequency independent damping is obtained by the having a spring and slider in series as shown in the following sketch:

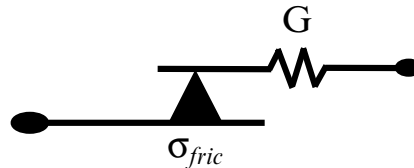

Several springs and sliders in series can be defined that are put in parallel to the rest of the stress contributions of this material model.

If a table for hysteresis is defined, then this is interpreted as follows. Let W_{dev} be the current value of the deviatoric strain energy density as calculated above. Furthermore, let \bar{W}_{dev} be the peak strain energy density reached up to this point in time. It is then assumed that the resulting stress is reduced by a factor due to damage according to

$$\mathbf{S} = D(W_{\text{dev}}, \bar{W}_{\text{dev}}) \frac{\partial W_{\text{dev}}}{\partial \mathbf{E}} + \frac{\partial W_{\text{vol}}}{\partial \mathbf{E}}$$

i.e., the deviatoric stress is reduced by damage factor that is given as input. The table should thus consist of curves for different values of \bar{W}_{dev} , where each curve gives the stress reduction (a value between 0 and 1) for a given value of W_{dev} . The abscissa values for a curve corresponding to a peak energy density of \bar{W}_{dev} should range from 0 to \bar{W}_{dev} , and the ordinate values should preferably increase with increasing W_{dev} and must take the value 1 when $W_{\text{dev}} = \bar{W}_{\text{dev}}$. This table can be estimated from a uniaxial quasistatic compression test. Let a test specimen of volume V be loaded and unloaded one cycle. We assume $f(d)$ to be the loading force as function of the displacement d , and $f_u(d)$ be the unloading curve. The specimen is loaded to maximum displacement \bar{d} before unloading. The strain energy density is then given as a function of the loaded displacement as

$$W_{\text{dev}}(d) = \frac{1}{V} \int_0^d f(s) ds$$

and the peak energy is of course given as $\bar{W}_{\text{dev}} = W_{\text{dev}}(\bar{d})$. From this energy curve we can also determine the inverse, i.e., the displacement $d(W_{\text{dev}})$. The curve to be input to LS-DYNA is then

$$D(W_{\text{dev}}, \bar{W}_{\text{dev}}) = \frac{f_u[d(W_{\text{dev}})]}{f[d(W_{\text{dev}})]}$$

This procedure is repeated for different values of \bar{d} .

*MAT_OGDEN_RUBBER

This is also Material Type 77. This material model provides the Ogden [1984] rubber model combined optionally with linear viscoelasticity as outlined by Christensen [1980].

Card 1	1	2	3	4	5	6	7	8
Variable	MID	R0	PR	N	NV	G	SIGF	REF
Type	A8	F	F	I	I	F	F	F

Hysteresis Card. Additional card read in when PR < 0 (Mullins Effect).

Card 2	1	2	3	4	5	6	7	8
Variable	TBHYS							
Type	F							

Card 3 for N > 0. For N > 0 a least squares fit is computed from uniaxial data.

Card 3	1	2	3	4	5	6	7	8
Variable	SGL	SW	ST	LCID1	DATA	LCID2	BSTART	TRAMP
Type	F	F	F	F	F	F		F

Card 3 for N = 0. Set the material parameters directly.

Card 3	1	2	3	4	5	6	7	8
Variable	MU1	MU2	MU3	MU4	MU5	MU6	MU7	MU8
Type	F	F	F	F	F	F	F	F

Card 4 for N = 0. Set the material parameters directly.

Card 4	1	2	3	4	5	6	7	8
Variable	ALPHA1	ALPHA2	ALPHA3	ALPHA4	ALPHA5	ALPHA6	ALPHA7	ALPHA8
Type	F	F	F	F	F	F	F	F

Optional Viscoelastic Constants Cards. Up to 12 cards may be input. A keyword card (with a "*" in column 1) terminates this input if less than 12 cards are used.

Card 5	1	2	3	4	5	6	7	8
Variable	GI	BETA1	VFLAG					
Type	F	F	I					
Default			0					

VARIABLE**DESCRIPTION**

MID	Material identification. A unique number or label not exceeding 8 characters must be specified.
RO	Mass density
PR	Poissons ratio (≥ 49 is recommended; smaller values may not work and should not be used). If this is set to a negative number, then the absolute value is used and an extra card is read for Mullins effect.
N	Order of fit to the Ogden model, (currently < 9 , 2 generally works okay). The constants generated during the fit are printed in the output file and can be directly input in future runs, thereby, saving the cost of performing the nonlinear fit. The users need to check the correction of the fit results before proceeding to compute.

VARIABLE	DESCRIPTION
NV	Number of Prony series terms in fit. If zero, the default is 6. Currently, the maximum number is set to 12. Values less than 12, possibly 3-5 are recommended, since each term used adds significantly to the cost. Caution should be exercised when taking the results from the fit. Preferably, all generated coefficients should be positive. Negative values may lead to unstable results. Once a satisfactory fit has been achieved it is recommended that the coefficients which are written into the output file be input in future runs.
G	Shear modulus for frequency independent damping. Frequency independent damping is based on a spring and slider in series. The critical stress for the slider mechanism is SIGF defined below. For the best results, the value of G should be 250-1000 times greater than SIGF.
SIGF	Limit stress for frequency independent frictional damping.
REF	Use reference geometry to initialize the stress tensor. The reference geometry is defined by the keyword: *INITIAL_FOAM_REFERENCE_GEOMETRY (see there for more details). EQ.0.0: off, EQ.1.0: on.
TBHYS	Table ID for hysteresis, see Remarks on MAT_HYPERELASTIC_RUBBER

If N > 0 test information from a uniaxial test are used:

SGL	Specimen gauge length
SW	Specimen width
ST	Specimen thickness
LCID1	Load curve ID giving the force versus actual change in the gauge length
DATA	Type of experimental data. EQ.1.0: uniaxial data (default) EQ.2.0: biaxial data EQ.3.0: pure shear data

VARIABLE	DESCRIPTION
LCID2	Load curve ID of relaxation curve. If constants β_l are determined via a least squares fit. This relaxation curve is shown in Figure 2-44 . This model ignores the constant stress.
BSTART	In the fit, β_1 is set to zero, β_2 is set to BSTART, β_3 is 10 times β_2 , β_4 is 10 times β_3 , and so on. If zero, BSTART is determined by an iterative trial and error scheme.
TRAMP	Optional ramp time for loading. If N = 0, the constants MU _i and ALPHA _i have to be defined:
MU _i	μ_i , the <i>i</i> th shear modulus, <i>i</i> varies up to 8. See discussion below.
ALPHA _i	α_i , the <i>i</i> th exponent, <i>i</i> varies up to 8. See discussion below.
GI	Optional shear relaxation modulus for the <i>i</i> th term
BETA _i	Optional decay constant if <i>i</i> th term
VFLAG	Flag for the viscoelasticity formulation. This appears only on the first line defining GI, BETA _i , and VFLAG. If VFLAG = 0, the standard viscoelasticity formulation is used (the default), and if VFLAG = 1, the viscoelasticity formulation using the instantaneous elastic stress is used.

Remarks:

Rubber is generally considered to be fully incompressible since the bulk modulus greatly exceeds the shear modulus in magnitude. To model the rubber as an unconstrained material a hydrostatic work term is included in the strain energy functional which is function of the relative volume, J , [Ogden 1984]:

$$W^* = \sum_{i=1}^3 \sum_{j=1}^n \frac{\mu_j}{\alpha_j} (\lambda_i^{*\alpha_j} - 1) + K(J - 1 - \ln J)$$

The asterisk (*) indicates that the volumetric effects have been eliminated from the principal stretches, λ_j^* . The number of terms, n , may vary between 1 to 8 inclusive, and K is the bulk modulus.

Rate effects are taken into account through linear viscoelasticity by a convolution integral of the form:

$$\sigma_{ij} = \int_0^t g_{ijkl}(t - \tau) \frac{\partial \varepsilon_{kl}}{\partial \tau} d\tau$$

or in terms of the second Piola-Kirchhoff stress, $\{S_0\}$, and Green's strain tensor, $\{S_{RT}\}$,

$$S_{ij} = \int_0^t G_{ijkl}(t - \tau) \frac{\partial E_{kl}}{\partial \tau} d\tau$$

where $g_{ijkl}(t - \tau)$ and $G_{ijkl}(t - \tau)$ are the relaxation functions for the different stress measures. This stress is added to the stress tensor determined from the strain energy functional.

If we wish to include only simple rate effects, the relaxation function is represented by six terms from the Prony series:

$$g(t) = \alpha_0 + \sum_{m=1}^N \alpha_m e^{-\beta t}$$

given by,

$$g(t) = \sum_{i=1}^n G_i e^{-\beta_i t}$$

This model is effectively a Maxwell fluid which consists of a dampers and springs in series. We characterize this in the input by shear moduli, G_i , and decay constants, β_i . The viscoelastic behavior is optional and an arbitrary number of terms may be used.

For VFLAG = 1, the viscoelastic term is

$$\sigma_{ij} = \int_0^t g_{ijkl}(t - \tau) \frac{\partial \sigma_{kl}^E}{\partial \tau} d\tau$$

where σ_{kl}^E is the instantaneous stress evaluated from the internal energy functional. The coefficients in the Prony series therefore correspond to normalized relaxation moduli instead of elastic moduli.

The Mooney-Rivlin rubber model (model 27) is obtained by specifying $n = 1$. In spite of the differences in formulations with Model 27, we find that the results obtained with this model are nearly identical with those of Material 27 as long as large values of Poisson's ratio are used.

The frequency independent damping is obtained by the having a spring and slider in series as shown in the following sketch:

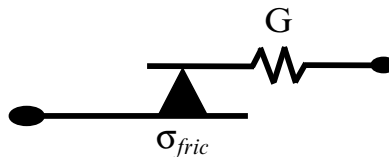

***MAT_SOIL_CONCRETE**

This is Material Type 78. This model permits concrete and soil to be efficiently modeled. See the explanations below.

Card 1	1	2	3	4	5	6	7	8
Variable	MID	RO	G	K	LCPV	LCYP	LCFP	LCRP
Type	A8	F	F	F	F	F	F	F

Card 2	1	2	3	4	5	6	7	8
Variable	PC	OUT	B	FAIL				
Type	F	F	F	F				

VARIABLE**DESCRIPTION**

MID	Material identification. A unique number or label not exceeding 8 characters must be specified.
RO	Mass density
G	Shear modulus
K	Bulk modulus
LCPV	Load curve ID for pressure versus volumetric strain. The pressure versus volumetric strain curve is defined in compression only. The sign convention requires that both pressure and compressive strain be defined as positive values where the compressive strain is taken as the negative value of the natural logarithm of the relative volume.
LCYP	Load curve ID for yield versus pressure: GT.0: von Mises stress versus pressure, LT.0: Second stress invariant, J_2 , versus pressure. This curve must be defined.
LCFP	Load curve ID for plastic strain at which fracture begins versus pressure. This load curve ID must be defined if $B > 0.0$.

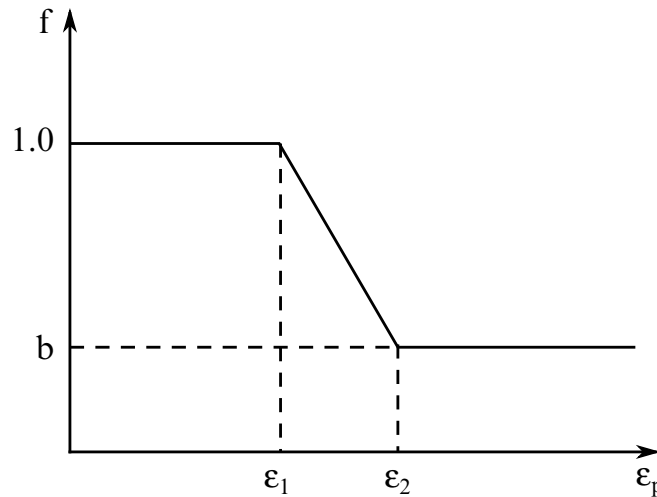

Figure 2-45. Strength reduction factor.

VARIABLE	DESCRIPTION
LCRP	Load curve ID for plastic strain at which residual strength is reached versus pressure. This load curve ID must be defined if $B > 0.0$.
PC	Pressure cutoff for tensile fracture
OUT	Output option for plastic strain in database: EQ.0: volumetric plastic strain, EQ.1: deviatoric plastic strain.
B	Residual strength factor after cracking, see Figure 2-45 .
FAIL	Flag for failure: EQ.0: no failure, EQ.1: When pressure reaches failure pressure element is eroded, EQ.2: When pressure reaches failure pressure element loses its ability to carry tension.

Remarks:

Pressure is positive in compression. Volumetric strain is defined as the natural log of the relative volume and is *positive* in compression where the relative volume, V , is the ratio of the current volume to the initial volume. The tabulated data should be given in order of increasing compression. If the pressure drops below the cutoff value specified, it is reset to that value and the deviatoric stress state is eliminated.

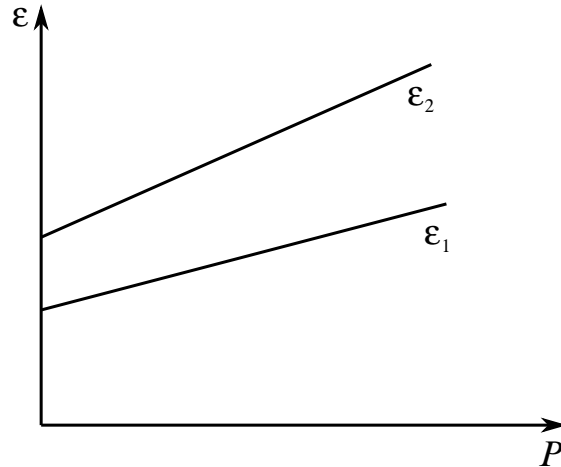

Figure 2-46. Cracking strain versus pressure.

If the load curve ID (LCYP) is provided as a positive number, the deviatoric, perfectly plastic, pressure dependent, yield function ϕ , is given as

$$\phi = \sqrt{3J_2} - F(p) = \sigma_y - F(p)$$

where $F(p)$ is a tabulated function of yield stress versus pressure, and the second invariant, J_2 , is defined in terms of the deviatoric stress tensor as:

$$J_2 = \frac{1}{2} S_{ij} S_{ij}$$

assuming that if the ID is given as negative then the yield function becomes:

$$\phi = J_2 - F(p)$$

being the deviatoric stress tensor.

If cracking is invoked by setting the residual strength factor, B, on card 2 to a value between 0.0 and 1.0, the yield stress is multiplied by a factor f which reduces with plastic strain according to a trilinear law as shown in [Figure 2-45](#).

b = residual strength factor

ϵ_1 = plastic stain at which cracking begins.

ϵ_2 = plastic stain at which residual strength is reached.

ϵ_1 and ϵ_2 are tabulated functions of pressure that are defined by load curves, see [Figure 2-46](#). The values on the curves are pressure versus strain and should be entered in order of increasing pressure. The strain values should always increase monotonically with pressure.

By properly defining the load curves, it is possible to obtain the desired strength and ductility over a range of pressures, see [Figure 2-47](#).

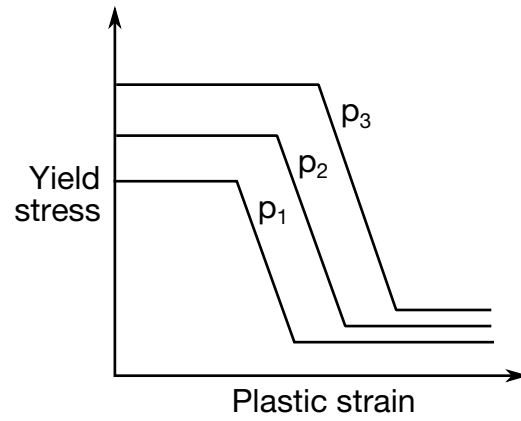

Figure 2-47. Yield stress as a function of plastic strain.

***MAT_HYSTERETIC_SOIL**

This is Material Type 79. This model is a nested surface model with up to ten superposed “layers” of elasto-perfectly plastic material, each with its own elastic moduli and yield values. Nested surface models give hysteric behavior, as the different “layers” yield at different stresses. See Remarks below.

Card 1	1	2	3	4	5	6	7	8
Variable	MID	RO	K0	P0	B	A0	A1	A2
Type	A8	F	F	F	F	F	F	F

Card 2	1	2	3	4	5	6	7	8
Variable	DF	RP	LCID	SFLC	DIL_A	DIL_B	DIL_C	DIL_D
Type	F	F	F	F	F	F	F	F

Card 3	1	2	3	4	5	6	7	8
Variable	GAM1	GAM2	GAM3	GAM4	GAM5			PINIT
Type	F	F	F	F	F			I

Card 4	1	2	3	4	5	6	7	8
Variable	TAU1	TAU2	TAU3	TAU4	TAU5			
Type	F	F	F	F	F			

VARIABLE**DESCRIPTION**

MID Material identification. A unique number or label not exceeding 8 characters must be specified.

RO Mass density

VARIABLE	DESCRIPTION
K0	Bulk modulus at the reference pressure
P0	Cut-off/datum pressure (must be $0 \leq$ i.e. tensile). Below this pressure, stiffness and strength disappears; this is also the “zero” pressure for pressure-varying properties.
B	B is the exponent for the pressure-sensitive elastic moduli. See remarks . B must be in the range $0 \leq B < 1$, and values too close to 1 are not recommended because the pressure becomes indeterminate.
A0	Yield function constant a_0 (Default = 1.0), see Material Type 5.
A1	Yield function constant a_1 (Default = 0.0), see Material Type 5.
A2	Yield function constant a_2 (Default = 0.0), see Material Type 5.
DF	Damping factor. Must be in the range $0 \leq df \leq 1$: EQ.0: no damping, EQ.1: maximum damping.
RP	Reference pressure for following input data.
LCID	Load curve ID defining shear strain verses shear stress. Up to ten points may be defined in the load curve. See *DEFINE_CURVE.
SFLD	Scale factor to apply to shear stress in LCID.
DIL_A	Dilation parameter A
DIL_B	Dilation parameter B
DIL_C	Dilation parameter C
DIL_D	Dilation parameter D
GAM1	γ_1 , shear strain (ignored if LCID is non zero).
GAM2	γ_2 , shear strain (ignored if LCID is non zero).
GAM3	γ_3 , shear strain (ignored if LCID is non zero).
GAM4	γ_4 , shear strain (ignored if LCID is non zero).
GAM5	γ_5 , shear strain (ignored if LCID is non zero).

VARIABLE	DESCRIPTION
TAU1	τ_1 , shear stress at γ_1 (ignored if LCID is non zero).
TAU2	τ_2 , shear stress at γ_2 (ignored if LCID is non zero).
TAU3	τ_3 , shear stress at γ_3 (ignored if LCID is non zero).
TAU4	τ_4 , shear stress at γ_4 (ignored if LCID is non zero).
TAU5	τ_5 , shear stress at γ_5 (ignored if LCID is non zero).
PINIT	Flag for pressure sensitivity (B and A0, A1, A2 equations): EQ.0: Use current pressure (will vary during the analysis) EQ.1: Use pressure from initial stress state EQ.2: Use initial "plane stress" pressure $(\sigma_v + \sigma_h)/2$ EQ.3: Use (compressive) initial vertical stress

Remarks:

The elastic moduli G and K are pressure sensitive:

$$G(p) = \frac{G_0(p - p_0)^b}{(p_{\text{ref}} - p_0)^b}$$

$$K(p) = \frac{K_0(p - p_0)^b}{(p_{\text{ref}} - p_0)^b}$$

where G_0 and K_0 are the input values, p is the current pressure, p_0 the cut-off or datum pressure (must be zero or negative). If p attempts to fall below p_0 (i.e., more tensile) the shear stresses are set to zero and the pressure is set to p_0 . Thus, the material has no stiffness or strength in tension. The pressure in compression is calculated as follows:

$$p = [-K_0 \ln(V)]^{1/(1-b)}$$

where V is the relative volume, i.e., the ratio between the original and current volume.

The constants a_0 , a_1 , a_2 govern the pressure sensitivity of the yield stress. Only the ratios between these values are important - the absolute stress values are taken from the stress-strain curve.

The stress strain pairs define a shear stress versus shear strain curve. The first point on the curve is assumed by default to be (0,0) and does not need to be entered. The slope of the curve must decrease with increasing γ . This curves applies at the reference pressure; at other pressures the curve is scaled by

$$\frac{\tau(p, \gamma)}{\tau(p_{ref}, \gamma)} = \sqrt{\frac{[a_0 + a_1(p - p_0) + a_2(p - p_0)^2]}{[a_0 + a_1(p_{ref} - p_0) + a_2(p_{ref} - p_0)^2]}}$$

The shear stress-strain curve (with points $(\tau_1, \gamma_1), (\tau_2, \gamma_2) \dots (\tau_N, \gamma_N)$) is converted into a series of N elastic perfectly-plastic curves such that $\sum(\tau_i, (\gamma)) = \tau(\gamma)$, as shown in the [figure 2-48](#).

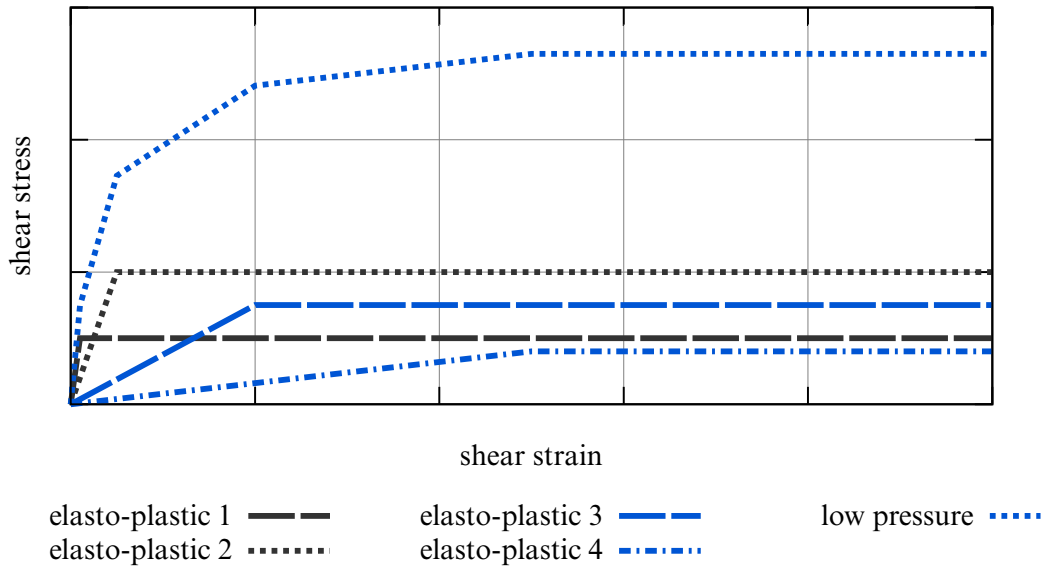

Figure 2-48.

Each elastic perfectly-plastic curve represents one “layer” in the material model. Deviatoric stresses are stored and calculated separately for each layer. The yield surface for each layer is defined in terms of stress invariant J_2 ; this is converted internally from the input values of maximum shear stress, assuming a uniaxial stress state:

$$J_{2i} = \left(\sigma'_i : \frac{\sigma'_i}{2} \right) < \frac{4(\tau_{maxi})^2}{3}$$

where subscript i denotes layer i and τ_{maxi} is the plastic shear stress of the layer.

In cases where the deviatoric stress state is closer to pure shear, the maximum shear stress reached by the material will be up to $\sqrt{4/3}$ times higher than the input curve. Users may wish to allow for this by reducing the input curve by this factor. When performing checks on the output, the following relationships may be useful:

Input shear stress is treated by the material model as,

$$0.5 \times \text{Von Mises Stress} = \sqrt{(3\sigma'_i : \sigma'_i/8)}.$$

Input shear strain is treated by the material model as

$$1.5 \times \text{Von Mises Strain} = \sqrt{(3\varepsilon'_i: \varepsilon'_i/2)}.$$

The total deviatoric stress is the sum of the deviatoric stresses in each layer. By this method, hysteretic (energy-absorbing) stress-strain curves are generated in response to any strain cycle of amplitude greater than the lowest yield strain of any layer. The example below shows response to small and large strain cycles (blue and pink lines) superposed on the input curve (thick red line).

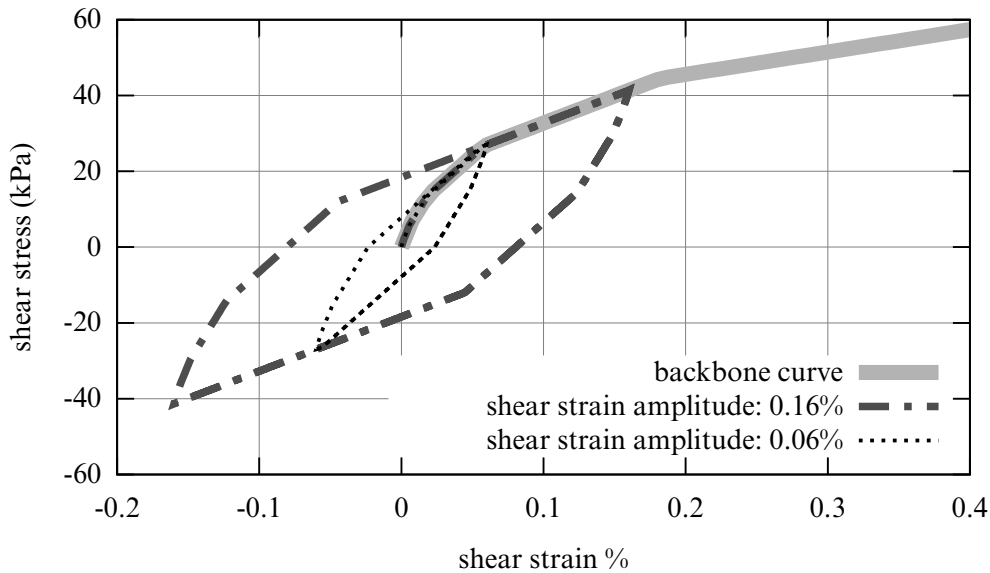

Figure 2-49.

Pressure Sensitivity:

The yield stresses of the layers, and hence the stress at each point on the shear stress-strain input curve, vary with pressure according to constants A0, A1 and A2. The elastic moduli, and hence also the slope of each section of shear stress-strain curve, vary with pressure according to constant B. These effects combine to modify the shear stress-strain curve according to pressure:

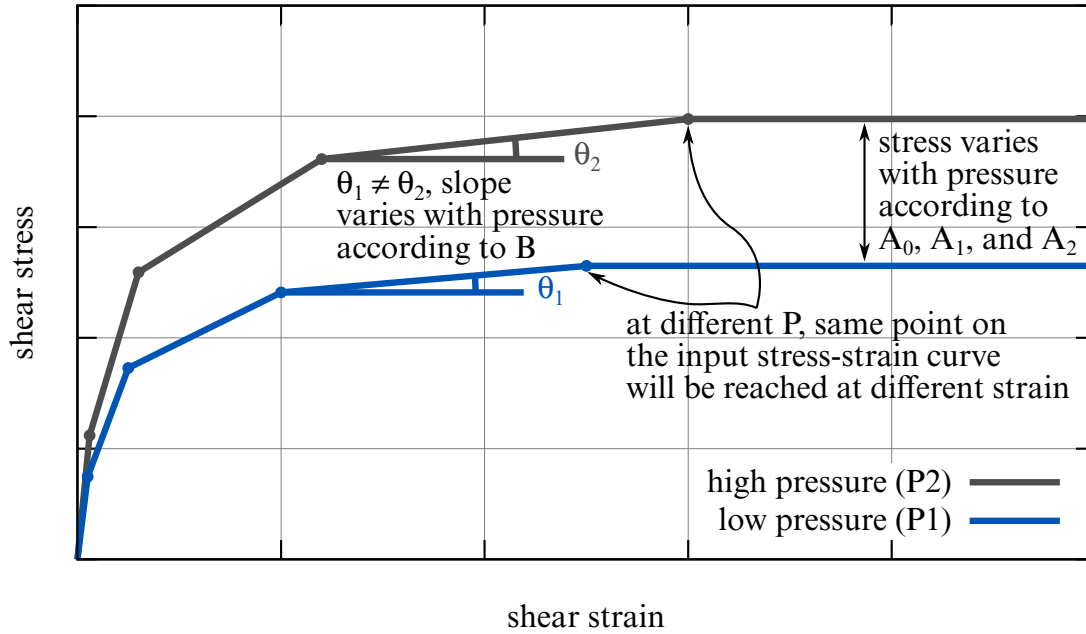

Figure 2-50.

Pressure sensitivity can make the solution sensitive to numerical noise. In cases where the expected pressure changes are small compared to the initial stress state, it may be preferable to use pressure from the initial stress state instead of current pressure as the basis for the pressure sensitivity (option PINIT). This causes the bulk modulus and shear stress-strain curve to be calculated once for each element at the start of the analysis and to remain fixed thereafter. PINIT affects both stiffness (calculated using B) and strength (calculated using A0, A1 and A2). If PINIT options 2 (“plane stress” pressure) or 3 (vertical stress) are used, these quantities substitute for pressure p in the equations above. Input values of p_{ref} and p_0 should then also be “plane stress” pressure or vertical stress, respectively.

If PINIT is used, B is allowed to be as high as 1.0 (stiffness proportional to initial pressure); otherwise, values of B higher than about 0.5 are not recommended.

Dilatancy:

Parameters DIL_A, DIL_B, DIL_C and DIL_D control the compaction and dilatancy that occur in sandy soils as a result of shearing motion. The dilatancy is expressed as a volume strain γ_v :

$$\begin{aligned} \epsilon_v &= \epsilon_r + \epsilon_g \\ \epsilon_r &= DIL_A(\Gamma)^{DIL_B} \end{aligned}$$

$$\varepsilon_g = \frac{\int (d\gamma_{xz}^2 + d\gamma_{yz}^2)^{1/2}}{\text{DIL_C} + \text{DIL_D} \times \int (d\gamma_{xz}^2 + d\gamma_{yz}^2)^{1/2}}$$

$$\Gamma = (\gamma_{xz}^2 + \gamma_{yz}^2)^{1/2}$$

$$\gamma_{xz} = 2\varepsilon_{xz}$$

$$\gamma_{yz} = 2\varepsilon_{yz}$$

γ_r describes the dilation of the soil due to the magnitude of the shear strains; this is caused by the soil particles having to climb over each other to develop shear strain.

γ_g describes compaction of the soil due to collapse of weak areas and voids, caused by continuous shear straining.

Recommended inputs for sandy soil:

DIL_A	-	10
DIL_B	-	1.6
DIL_C	-	100
DIL_D	-	2.5

DIL_A and DIL_B may cause instabilities in some models. If this facility is used with pore water pressure, liquefaction can be modeled.

***MAT_RAMBERG-OSGOOD**

This is Material Type 80. This model is intended as a simple model of shear behavior and can be used in seismic analysis.

Card 1	1	2	3	4	5	6	7	8
Variable	MID	RO	GAMY	TAUY	ALPHA	R	BULK	
Type	A8	F	F	F	F	F	F	
Default	none	none	none	none	none	none	none	

VARIABLE**DESCRIPTION**

MID	Material identification. A unique number or label not exceeding 8 characters must be specified.
RO	Mass density.
GAMY	Reference shear strain (γ_y)
TAUY	Reference shear stress (τ_y)
ALPHA	Stress coefficient (α)
R	Stress exponent (r)
BULK	Elastic bulk modulus

Remarks:

The Ramberg-Osgood equation is an empirical constitutive relation to represent the one-dimensional elastic-plastic behavior of many materials, including soils. This model allows a simple rate independent representation of the hysteretic energy dissipation observed in soils subjected to cyclic shear deformation. For monotonic loading, the stress-strain relationship is given by:

$$\frac{\gamma}{\gamma_y} = \frac{\tau}{\tau_y} + \alpha \left| \frac{\tau}{\tau_y} \right|^r, \text{ for } \gamma \geq 0$$

$$\frac{\gamma}{\gamma_y} = \frac{\tau}{\tau_y} - \alpha \left| \frac{\tau}{\tau_y} \right|^r, \text{ for } \gamma < 0$$

where γ is the shear and τ is the stress. The model approaches perfect plasticity as the stress exponent $r \rightarrow \infty$. These equations must be augmented to correctly model unloading and reloading material behavior. The first load reversal is detected by $\gamma\dot{\gamma} < 0$. After the first reversal, the stress-strain relationship is modified to

$$\frac{(\gamma - \gamma_0)}{2\gamma_y} = \frac{(\tau - \tau_0)}{2\tau_y} + \alpha \left| \frac{(\tau - \tau_0)}{2\tau_y} \right|', \text{ for } \gamma \geq 0$$
$$\frac{(\gamma - \gamma_0)}{2\gamma_y} = \frac{(\tau - \tau_0)}{2\tau_y} - \alpha \left| \frac{(\tau - \tau_0)}{2\tau_y} \right|', \text{ for } \gamma < 0$$

where γ_0 and τ_0 represent the values of strain and stress at the point of load reversal. Subsequent load reversals are detected by $(\gamma - \gamma_0)\dot{\gamma} < 0$.

The Ramberg-Osgood equations are inherently one-dimensional and are assumed to apply to shear components. To generalize this theory to the multidimensional case, it is assumed that each component of the deviatoric stress and deviatoric tensorial strain is independently related by the one-dimensional stress-strain equations. A projection is used to map the result back into deviatoric stress space if required. The volumetric behavior is elastic, and, therefore, the pressure p is found by

$$p = -K\varepsilon_v$$

where ε_v is the volumetric strain.

***MAT_PLASTICITY_WITH_DAMAGE_{OPTION}**

This is Material Types 81 and 82. An elasto-visco-plastic material with an arbitrary stress versus strain curve and arbitrary strain rate dependency can be defined. Damage is considered before rupture occurs. Also, failure based on a effective plastic strain or a minimum time step size can be defined.

Available options include:

<BLANK>

ORTHO

ORTHO_RCDC

ORTHO_RCDC1980

STOCHASTIC

Including ORTHO invokes an orthotropic damage model, an extension first added as a means of treating failure in aluminum panels. Directional damage begins after a defined failure strain is reached in tension and continues to evolve until a tensile rupture strain is reached in either one of the two orthogonal directions. After rupture is detected at all integration points, the element is deleted. The option ORTHO_RCDC invokes the damage model developed by Wilkins [Wilkins, et al. 1977]. The option ORTHO_RCDC1980 invokes a damage model based on strain invariants as developed by Wilkins [Wilkins, et al. 1980]. A nonlocal formulation, which requires additional storage, is used if a characteristic length is defined. The RCDC option, which was added at the request of Toyota, works well in predicting failure in cast aluminum; see Yamasaki, et al., [2006].

Card 1	1	2	3	4	5	6	7	8
Variable	MID	RO	E	PR	SIGY	ETAN	EPPF	TDEL
Type	A8	F	F	F	F	F	F	F
Default	none	none	none	none	none	0.0	10.E+20	10.E+20

Card 2	1	2	3	4	5	6	7	8
Variable	C	P	LCSS	LCSR	EPPFR	VP	LCDM	NUMINT
Type	F	F	F	F	F	F	F	I
Default	0	0	0	0	0	0	0	0

Card 3	1	2	3	4	5	6	7	8
Variable	EPS1	EPS2	EPS3	EPS4	EPS5	EPS6	EPS7	EPS8
Type	F	F	F	F	F	F	F	F
Default	0	0	0	0	0	0	0	0

Card 4	1	2	3	4	5	6	7	8
Variable	ES1	ES2	ES3	ES4	ES5	ES6	ES7	ES8
Type	F	F	F	F	F	F	F	F
Default	0	0	0	0	0	0	0	0

Ortho RCDC Card. Additional card for keyword option ORTHO_RCDC.

Card 5	1	2	3	4	5	6	7	8
Variable	ALPHA	BETA	GAMMA	D0	B	LAMBDA	DS	L
Type	F	F	F	F	F	F	F	F
Default	0	0	0	0	0	0	0	0

VARIABLE	DESCRIPTION
MID	Material identification. A unique number or label not exceeding 8 characters must be specified.
RO	Mass density.
E	Young's modulus.
PR	Poisson's ratio.
SIGY	Yield stress.
ETAN	Tangent modulus, ignored if (LCSS.GT.0) is defined.
EPPF	$\epsilon_{failure}^p$, effective plastic strain at which material softening begins.
TDEL	Minimum time step size for automatic element deletion.
C	Strain rate parameter, C, see formula below.
P	Strain rate parameter, P, see formula below.
LCSS	Load curve ID or Table ID. Load curve ID defining effective stress versus effective plastic strain. If defined EPS1 - EPS8 and ES1 - ES8 are ignored. The table ID defines for each strain rate value a load curve ID giving the stress versus effective plastic strain for that rate, See Figure 2-12 . The stress versus effective plastic strain curve for the lowest value of strain rate is used if the strain rate falls below the minimum value. Likewise, the stress versus effective plastic strain curve for the highest value of strain rate is used if the strain rate exceeds the maximum value. The strain rate parameters: C and P; the curve ID, LCSR; EPS1 - EPS8 and ES1 - ES8 are ignored if a Table ID is defined. NOTE: The strain rate values defined in the table may be given as the natural logarithm of the strain rate. If the first stress-strain curve in the table corresponds to a negative strain rate, LS-DYNA assumes that the natural logarithm of the strain rate value is used. Since the tables are internally discretized to equally space the points, natural logarithms are necessary, for example, if the curves correspond to rates from 10.e-04 to 10.e+04.
LCSR	Load curve ID defining strain rate scaling effect on yield stress.
EPPFR	$\epsilon_{rupture}^p$, effective plastic strain at which material ruptures.

VARIABLE	DESCRIPTION
VP	Formulation for rate effects: EQ.0.0: Scale yield stress (default), EQ.1.0: Viscoplastic formulation.
LCDM	Load curve ID defining nonlinear damage curve.
NUMINT	Number of through thickness integration points which must fail before the element is deleted. (If zero, all points must fail.) The default of all integration points is not recommended since elements undergoing large strain are often not deleted due to nodal fiber rotations which limit strains at active integration points after most points have failed. Better results are obtained if NUMINT is set to 1 or a number less than one half of the number of through thickness points. For example, if four through thickness points are used, NUMINT should not exceed 2, even for fully integrated shells which have 16 integration points.
EPS1 - EPS8	Effective plastic strain values (optional if SIGY is defined). At least 2 points should be defined.
ES1 - ES8	Corresponding yield stress values to EPS1 - EPS8.
ALPHA	Parameter α . for the Rc-Dc model
BETA	Parameter β . for the Rc-Dc model
GAMMA	Parameter γ . for the Rc-Dc model
D0	Parameter D_0 . for the Rc-Dc model
B	Parameter b . for the Rc-Dc model
LAMBDA	Parameter λ . for the Rc-Dc model
DS	Parameter D_s . for the Rc-Dc model
L	Optional characteristic element length for this material. We recommend that the default of 0 always be used, especially in parallel runs. If zero, nodal values of the damage function are used to compute the damage gradient. See discussion below.

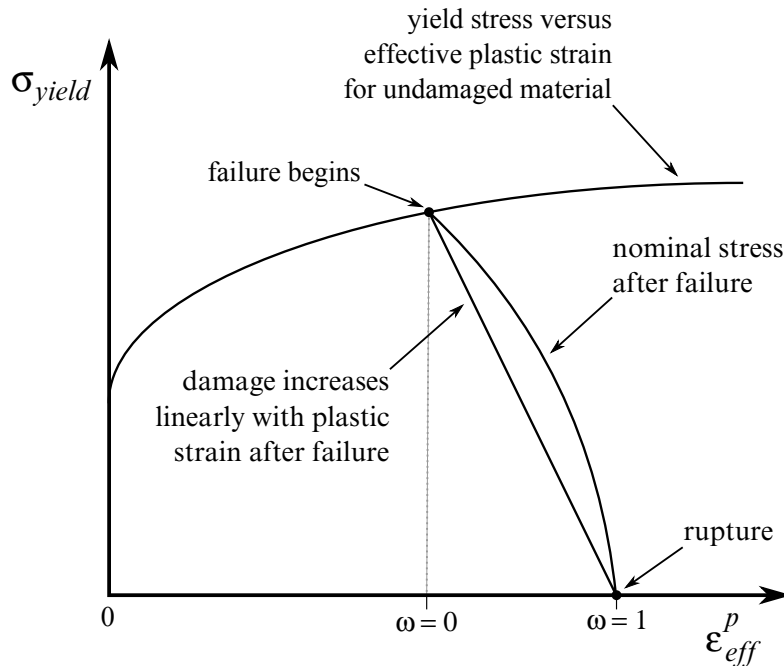

Figure 2-51. Stress strain behavior when damage is included

Remarks:

The stress strain behavior may be treated by a bilinear stress strain curve by defining the tangent modulus, ETAN. Alternately, a curve similar to that shown in [Figure 2-12](#) is expected to be defined by (EPS1, ES1) - (EPS8, ES8); however, an effective stress versus effective plastic strain curve (LCSS) may be input instead if eight points are insufficient. The cost is roughly the same for either approach. The most general approach is to use the table definition (LCSS) discussed below.

Three options to account for strain rate effects are possible:

1. Strain rate may be accounted for using the Cowper and Symonds model which scales the yield stress with the factor

$$1 + \left(\frac{\dot{\epsilon}}{C} \right)^{1/6}$$

2. where $\dot{\epsilon}$ is the strain rate, $\dot{\epsilon} = \sqrt{\dot{\epsilon}_{ij}\dot{\epsilon}_{ij}}$.

3. If the viscoplastic option is active, VP = 1.0, and if SIGY is > 0 then the dynamic yield stress is computed from the sum of the static stress, $\sigma_y^s(\epsilon_{eff}^p)$, which is typically given by a load curve ID, and the initial yield stress, SIGY, multiplied by the Cowper-Symonds rate term as follows:

$$\sigma_y(\varepsilon_{\text{eff}}^p, \dot{\varepsilon}_{\text{eff}}^p) = \sigma_y^s(\varepsilon_{\text{eff}}^p) + \text{SIGY} \times \left(\frac{\dot{\varepsilon}_{\text{eff}}^p}{C} \right)^{1/p}$$

where the plastic strain rate is used. With this latter approach similar results can be obtained between this model and material model: *MAT_ANISOTROPIC_VISCOPLASTIC. If SIGY = 0, the following equation is used instead where the static stress, $\sigma_y^s(\varepsilon_{\text{eff}}^p)$, must be defined by a load curve:

$$\sigma_y(\varepsilon_{\text{eff}}^p, \dot{\varepsilon}_{\text{eff}}^p) = \sigma_y^s(\varepsilon_{\text{eff}}^p) \left[1 + \left(\frac{\dot{\varepsilon}_{\text{eff}}^p}{C} \right)^{1/p} \right]$$

4. This latter equation is always used if the viscoplastic option is off.
5. For complete generality a load curve (LCSR) to scale the yield stress may be input instead. In this curve the scale factor versus strain rate is defined.
6. If different stress versus strain curves can be provided for various strain rates, the option using the reference to a table (LCSS) can be used. Then the table input in *DEFINE_TABLE is expected, see [Figure 2-12](#).

The constitutive properties for the damaged material are obtained from the undamaged material properties. The amount of damage evolved is represented by the constant, ω , which varies from zero if no damage has occurred to unity for complete rupture. For uniaxial loading, the nominal stress in the damaged material is given by

$$\sigma_{\text{nominal}} = \frac{P}{A}$$

where P is the applied load and A is the surface area. The true stress is given by:

$$\sigma_{\text{true}} = \frac{P}{A - A_{\text{loss}}}$$

where A_{loss} is the void area. The damage variable can then be defined:

$$\omega = \frac{A_{\text{loss}}}{A}$$

such that

$$0 \leq \omega \leq 1.$$

In this model damage is defined in terms of effective plastic strain after the failure strain is exceeded:

$$\omega = \frac{\varepsilon_{\text{eff}}^p - \varepsilon_{\text{failure}}^p}{\varepsilon_{\text{rupture}}^p - \varepsilon_{\text{failure}}^p}, \text{ for } \varepsilon_{\text{failure}}^p \leq \varepsilon_{\text{eff}}^p \leq \varepsilon_{\text{rupture}}^p$$

After exceeding the failure strain softening begins and continues until the rupture strain is reached.

The Rc-Dc model is defined as:

The damage D is given by

$$D = \int \omega_1 \omega_2 d\varepsilon^p$$

where ε^p is the effective plastic strain,

$$\omega_1 = \left(\frac{1}{1 - \gamma \sigma_m} \right)^\alpha$$

is a triaxial stress weighting term and

$$\omega_2 = (2 - A_D)^\beta$$

is a asymmetric strain weighting term. In the above σ_m is the mean stress. For A_D we use

$$A_D = \min \left(\left| \frac{\sigma_2}{\sigma_3} \right|, \left| \frac{\sigma_3}{\sigma_2} \right| \right)$$

where σ_i are the principal stresses and $\sigma_1 > \sigma_2 > \sigma_3$. Fracture is initiated when the accumulation of damage is

$$\frac{D}{D_c} > 1$$

where D_c is the a critical damage given by

$$D_c = D_0(1 + b|\nabla D|^\lambda)$$

A fracture fraction,

$$F = \frac{D - D_c}{D_s}$$

defines the degradations of the material by the Rc-Dc model.

For the Rc-Dc model the gradient of damage needs to be estimated. The damage is connected to the integration points, and, thus, the computation of the gradient requires some manipulation of the LS-DYNA source code. Provided that the damage is connected to nodes, it can be seen as a standard bilinear field and the gradient is easily obtained. To enable this, the damage at the integration points are transferred to the nodes as follows. Let E_n be the set of elements sharing node n , E_n the number of elements in that set, P_e the set of integration points in element e and $|P_e|$ the number of points in that set. The average damage \bar{D}_e in element e is computed as

$$\bar{D}_e = \frac{\sum_{p \in P_e} D_p}{|P_e|}$$

where D_p is the damage in integration point p . Finally, the damage value in node n is estimated as

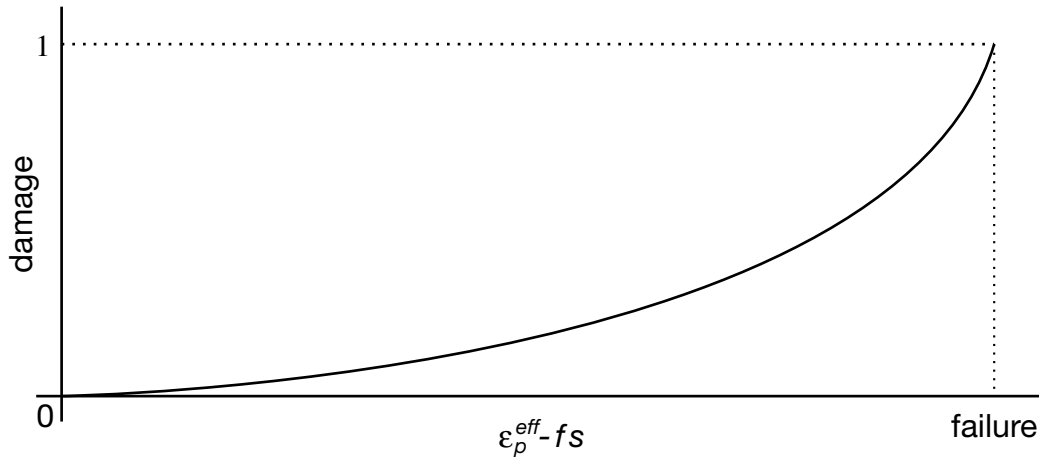

Figure 2-52. A nonlinear damage curve is optional. Note that the origin of the curve is at (0,0). It is permissible to input the failure strain EPPF as zero for this option. The nonlinear damage curve is useful for controlling the softening behavior after the failure strain is reached.

$$D_n = \frac{\sum_{e \in E_n} \bar{D}_e}{|E_n|}$$

This computation is performed in each time step and requires additional storage. Currently we use three times the total number of nodes in the model for this calculation, but this could be reduced by a considerable factor if necessary. There is an Rc-Dc option for the Gurson dilatational-plastic model. In the implementation of this model, the norm of the gradient is computed differently. Let E_f^l be the set of elements from within a distance l of element, f not including the element itself, and let $|E_f^l|$ be the number of elements in that set. The norm of the gradient of damage is estimated roughly as

$$\|\nabla D\|_f \approx \frac{1}{|E_f^l|} \sum_{e \in E_f^l} \frac{|D_e - D_f|}{d_{ef}}$$

where d_{ef} is the distance between element f and e .

The reason for taking the first approach is that it should be a better approximation of the gradient, it can for one integration point in each element be seen as a weak gradient of an elementwise constant field. The memory consumption as well as computational work should not be much higher than for the other approach.

The RCDC1980 model is identical to the RCDC model except the expression for A_D is in terms of the principal stress deviators and takes the form

$$A_D = \max \left(\left| \frac{S_2}{S_3} \right|, \left| \frac{S_2}{S_1} \right| \right)$$

The STOCHASTIC option allows spatially varying yield and failure behavior. See *DEFINE_STOCHASTIC_VARIATION for additional information.

***MAT_FU_CHANG_FOAM_{OPTION}**

This is Material Type 83.

Available options include:

DAMAGE_DECAY

LOG_LOG_INTERPOLATION

Rate effects can be modeled in low and medium density foams, see [Figure 2-53](#). Hysteretic unloading behavior in this model is a function of the rate sensitivity with the most rate sensitive foams providing the largest hysteresis and vice versa. The unified constitutive equations for foam materials by Chang [1995] provide the basis for this model. The mathematical description given below is excerpted from the reference. Further improvements have been incorporated based on work by Hirth, Du Bois, and Weimar [1998]. Their improvements permit: load curves generated by drop tower test to be directly input, a choice of principal or volumetric strain rates, load curves to be defined in tension, and the volumetric behavior to be specified by a load curve.

The unloading response was generalized by Kolling, Hirth, Erhart and Du Bois [2006] to allow the Mullin's effect to be modeled, i.e., after the first loading and unloading, further reloading occurs on the unloading curve. If it is desired to reload on the loading curves with the new generalized unloading, the DAMAGE decay option is available which allows the reloading to quickly return to the loading curve as the damage parameter decays back to zero in tension and compression.

Card 1	1	2	3	4	5	6	7	8
Variable	MID	R0	E	KCON	TC	FAIL	DAMP	TBID
Type	A8	F	F	F	F	F	F	F
Default	none	none	none	none	1.E+20	none	none	none
Remarks								5

Card 2	1	2	3	4	5	6	7	8
Variable	BVFLAG	SFLAG	RFLAG	TFLAG	PVID	SRAF	REF	HU
Type	F	F	F	F	F	F	F	F
Default	1.0	0.0	0.0	0.0	0.0	0.0	0.0	1.0
Remarks	1	2	3		4			5

Card 3 for DAMAGE_DECAY keyword option.

Card 3	1	2	3	4	5	6	7	8
Variable	MINR	MAXR	SHAPE	BETAT	BETAC			
Type	F	F	F	F	F			
Default	0.0	0.0	0.0	0.0	0.0			

Card 3 for keyword option *NOT* set to DAMAGE_DECAY.

Card 3	1	2	3	4	5	6	7	8
Variable	D0	N0	N1	N2	N3	C0	C1	C2
Type	F	F	F	F	F	F	F	F
Default	0.0	0.0	0.0	0.0	0.0	0.0	0.0	0.0

Card 4 for keyword option *NOT* set to DAMAGE_DECAY.

Card 4	1	2	3	4	5	6	7	8
Variable	C3	C4	C5	AIJ	SIJ	MINR	MAXR	SHAPE
Type	F	F	F	F	F	F	F	F
Default	0.0	0.0	0.0	0.0	0.0	0.0	0.0	0.0

VARIABLE**DESCRIPTION**

MID	Material identification. A unique number or label not exceeding 8 characters must be specified.
RO	Mass density
E	Young's modulus
KCON	Optional Young's modulus used in the computation of sound speed. This will influence the time step, contact forces, hourglass stabilization forces, and the numerical damping (DAMP). EQ.0.0: KCON is set equal to the max(E, current tangent to stress-strain curve) if TBID.ne.0. If TBID.eq.0, KCON is set equal to the maximum slope of the stress-strain curve.
TC	Tension cut-off stress
FAIL	Failure option after cutoff stress is reached: EQ.0.0: tensile stress remains at cut-off value, EQ.1.0: tensile stress is reset to zero.
DAMP	Viscous coefficient (.05 < recommended value < .50) to model damping effects.
TBID	Table ID, see *DEFINE_TABLE, for nominal stress vs. strain data as a function of strain rate. If the table ID is provided, cards 3 and 4 may be left blank and the fit will be done internally. The Table ID can be positive or negative (see remark 5 below).

VARIABLE	DESCRIPTION
BVFLAG	Bulk viscosity activation flag, see remark below: EQ.0.0: no bulk viscosity (recommended), EQ.1.0: bulk viscosity active.
SFLAG	Strain rate flag (see remark 2 below): EQ.0.0: true constant strain rate, EQ.1.0: engineering strain rate.
RFLAG	Strain rate evaluation flag: EQ.0.0: first principal direction, EQ.1.0: principal strain rates for each principal direction, EQ.2.0: volumetric strain rate.
TFLAG	Tensile stress evaluation: EQ.0.0: linear in tension. EQ.1.0: input via load curves with the tensile response corresponds to negative values of stress and strain.
PVID	Optional load curve ID defining pressure versus volumetric strain.
SRAF	Strain rate averaging flag. EQ.0.0: use weighted running average. EQ.1.0: average the last twelve values.
REF	Use reference geometry to initialize the stress tensor. The reference geometry is defined by the keyword: *INITIAL_FOAM_REFERENCE_GEOMETRY (see there for more details). EQ.0.0: off, EQ.1.0: on.
HU	Hysteretic unloading factor between 0 and 1 (default = 1, i.e., no energy dissipation), see also Figure 2-56
D0	material constant, see equations below.
N0	material constant, see equations below.
N1	material constant, see equations below.

VARIABLE	DESCRIPTION
N2	material constant, see equations below.
N3	material constant, see equations below.
C0	material constant, see equations below.
C1	material constant, see equations below.
C2	material constant, see equations below.
C3	material constant, see equations below.
C4	material constant, see equations below.
C5	material constant, see equations below.
AIJ,	material constant, see equations below.
SIJ	material constant, see equations below.
MINR	Ratemin, minimum strain rate of interest.
MAXR	Ratemax, maximum strain rate of interest.
SHAPE	Shape factor for unloading. Active for nonzero values of the hysteretic unloading factor HU. Values less than one reduces the energy dissipation and greater than one increases dissipation, see also Figure 2-54 .
BETAT	Decay constant for damage in tension. The damage decays after loading in ceases according to $e^{-\text{BETAT} \times t}$.
BETAC	Decay constant for damage in compression. . The damage decays after loading in ceases according to $e^{-\text{BETAC} \times t}$.

Material Formulation:

The strain is divided into two parts: a linear part and a non-linear part of the strain

$$E(t) = E^L(t) + E^N(t)$$

and the strain rate become

$$\dot{E}(t) = \dot{E}^L(t) + \dot{E}^N(t)$$

\dot{E}^N is an expression for the past history of E^N . A postulated constitutive equation may be written as:

$$\sigma(t) = \int_{\tau=0}^{\infty} [E_t^N(\tau), S(t)] d\tau$$

where $S(t)$ is the state variable and $\int_{\tau=0}^{\infty}$ is a functional of all values of τ in $T_\tau: 0 \leq \tau \leq \infty$ and

$$E_t^N(\tau) = E^N(t - \tau)$$

where τ is the history parameter:

$$E_t^N(\tau = \infty) \Leftrightarrow \text{the virgin material}$$

It is assumed that the material remembers only its immediate past, i.e., a neighborhood about $\tau = 0$. Therefore, an expansion of $E_t^N(\tau)$ in a Taylor series about $\tau = 0$ yields:

$$E_t^N(\tau) = E^N(0) + \frac{\partial E_t^N}{\partial t}(0)dt$$

Hence, the postulated constitutive equation becomes:

$$\sigma(t) = \sigma^*[E^N(t), \dot{E}^N(t), S(t)]$$

where we have replaced $\frac{\partial E_t^N}{\partial t}$ by \dot{E}^N , and σ^* is a function of its arguments.

For a special case,

$$\sigma(t) = \sigma^*(E^N(t), S(t))$$

we may write

$$\dot{E}_t^N = f(S(t), s(t))$$

which states that the nonlinear strain rate is the function of stress and a state variable which represents the history of loading. Therefore, the proposed kinetic equation for foam materials is:

$$\dot{E}_t^N = \frac{\sigma}{\|\sigma\|} D_0 \exp \left\{ -c_0 \left[\frac{\text{tr}(\sigma S)}{(\|\sigma\|)^2} \right]^{2n_0} \right\}$$

where D_0 , c_0 , and n_0 are material constants, and S is the overall state variable. If either $D_0 = 0$ or $c_0 \rightarrow \infty$ then the nonlinear strain rate vanishes.

$$\dot{S}_{ij} = [c_1(a_{ij}R - c_2S_{ij})P + c_3W^{n_1}(\|\dot{E}^N\|)^{n_2}I_{ij}]R$$

$$R = 1 + c_4 \left[\frac{\|\dot{E}^N\|}{c_5} - 1 \right]^{n_3}$$

$$P = \text{tr}(\sigma \dot{E}^N)$$

$$W = \int \text{tr}(\sigma(dE))$$

where $c_1, c_2, c_3, c_4, c_5, n_1, n_2, n_3,$ and a_{ij} are material constants and:

$$\|\sigma\| = (\sigma_{ij}\sigma_{ij})^{\frac{1}{2}}$$

$$\|\dot{E}\| = (\dot{E}_{ij}\dot{E}_{ij})^{\frac{1}{2}}$$

$$\|\dot{E}^N\| = (\dot{E}^N_{ij}\dot{E}^N_{ij})^{\frac{1}{2}}$$

In the implementation by Fu Chang the model was simplified such that the input constants a_{ij} and the state variables S_{ij} are scalars.

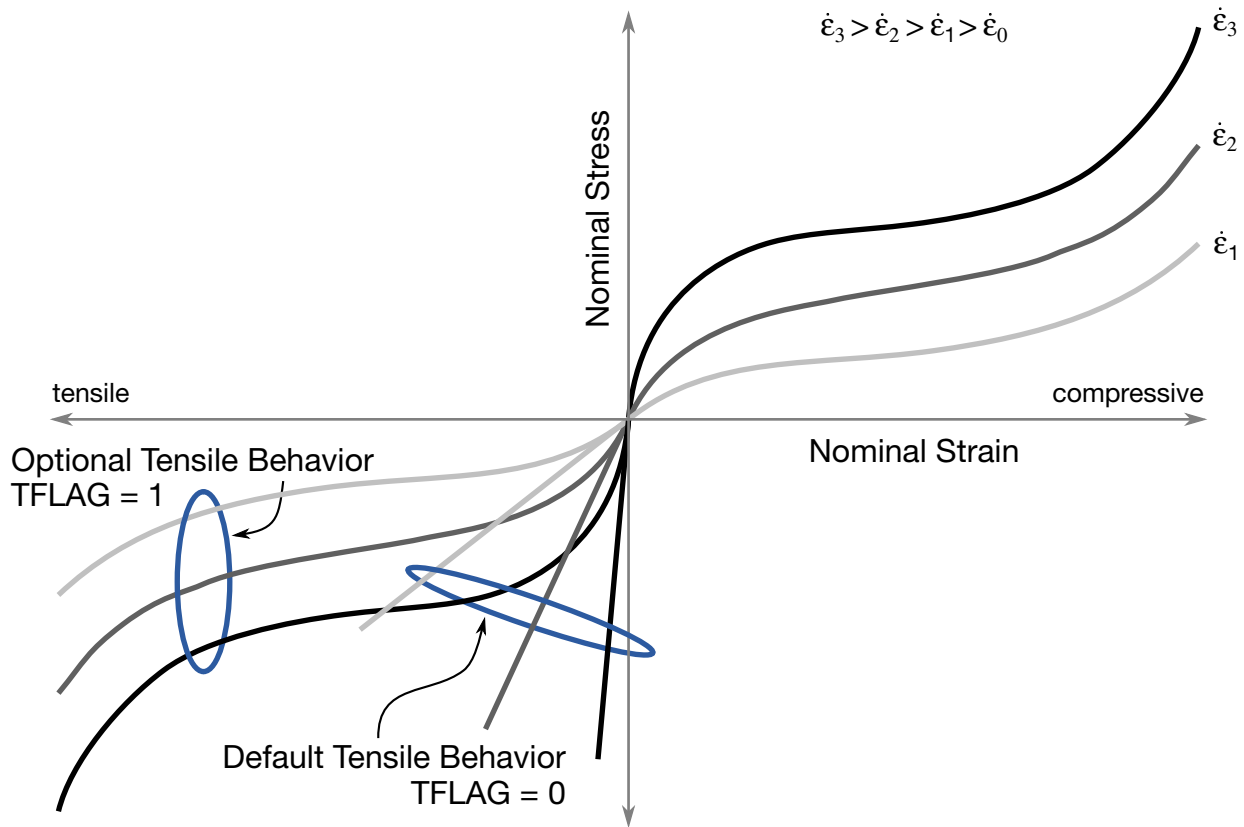

Figure 2-53. Nominal stress versus engineering strain curves, which are used to model rate effects in Fu Chang’s foam model.

Additional Remarks:

1. The bulk viscosity, which generates a rate dependent pressure, may cause an unexpected volumetric response and consequently, it is optional with this model.
2. Dynamic compression tests at the strain rates of interest in vehicle crash are usually performed with a drop tower. In this test the loading velocity is nearly constant but the true strain rate, which depends on the instantaneous specimen thickness, is

not. Therefore, the engineering strain rate input is optional so that the stress strain curves obtained at constant velocity loading can be used directly.

3. To further improve the response under multiaxial loading, the strain rate parameter can either be based on the principal strain rates or the volumetric strain rate.
4. Correlation under triaxial loading is achieved by directly inputting the results of hydrostatic testing in addition to the uniaxial data. Without this additional information which is fully optional, triaxial response tends to be underestimated.
5. Several options are available to control unloading response in MAT_083:
 - a) $HU = 0$ and $TBID > 0$

This is the old way. In this case the unloading response will follow the curve with the lowest strain rate and is rate-independent. The curve with lowest strain rate value (typically zero) in TBID should correspond to the unloading path of the material as measured in a quasistatic test. The quasistatic loading path then corresponds to a realistic (small) value of the strain rate.

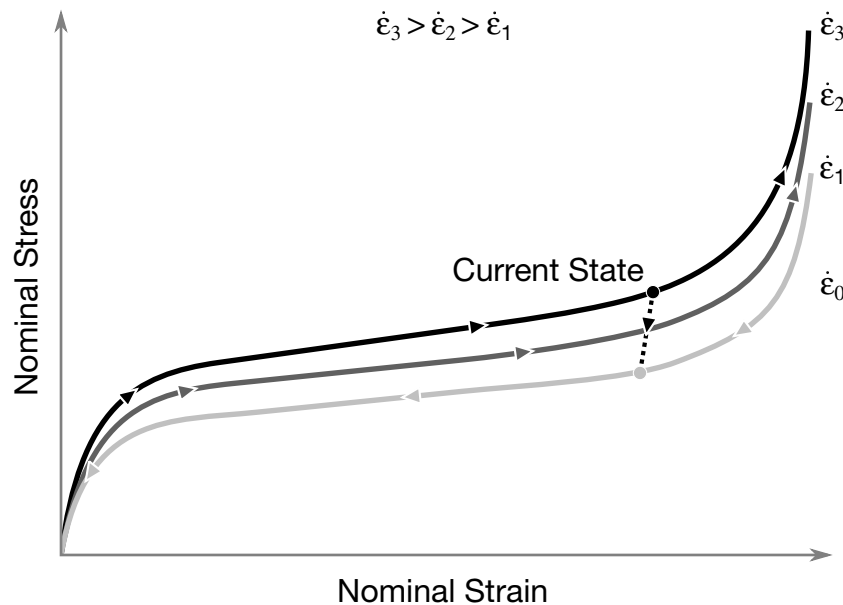

Figure 2-54. $HU = 0$, $TBID > 0$

- b) $HU = 0$ and $TBID < 0$

In this case the curve with lowest strain rate value (typically zero) in TBID must correspond to the unloading path of the material as measured in a quasistatic test. The quasistatic loading path then corresponds to a realistic (small) value of the strain rate. The quasistatic loading and unloading path (thus the first two curves of the table) should form a closed loop. The unloading response is given by a damage formulation for the principal stresses as follows:

$$\sigma_i = (1 - d)\sigma_i$$

The damage parameter d is computed internally in such a way that the unloading path under uniaxial tension and compression is fitted exactly in the simulation. The unloading response is rate dependent in this case.

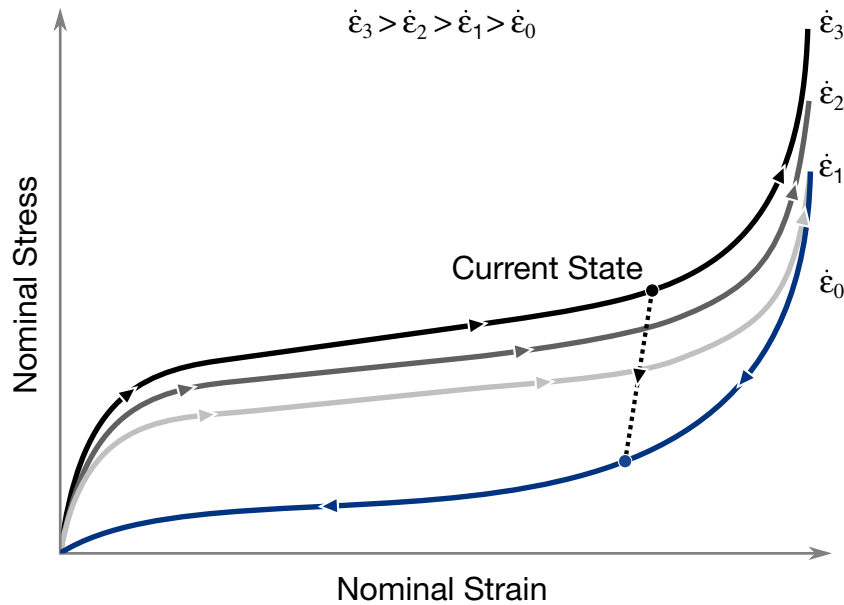

Figure 2-55. $HU = 0, TBID > 0$

c) $HU > 0$ and $TBID > 0$

No unloading curve should be provided in the table and the curve with the lowest strain rate value in TBID should correspond to the loading path of the material as measured in a quasistatic test. In this case the unloading response is given by a damage formulation for the principal stresses as follows:

$$\sigma_i = (1 - d)\sigma_i$$

$$d = (1 - HU) \left[1 - \left(\frac{W_{cur}}{W_{max}} \right)^{SHAPE} \right]$$

where W corresponds to the current value of the hyperelastic energy per unit undeformed volume. The unloading response is rate dependent in this case.

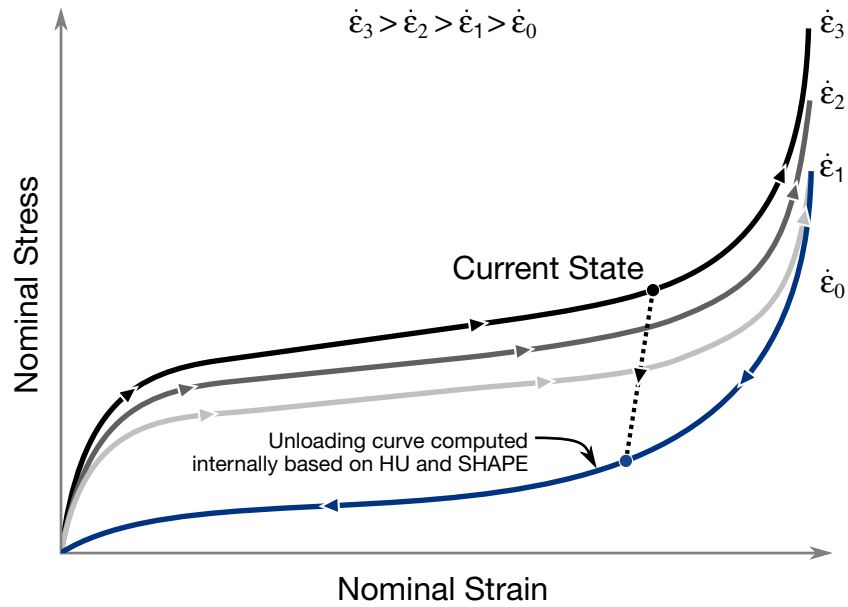

Figure 2-56. $HU > 0, TBID > 0$

The LOG_LOG_INTERPOLATION option uses log-log interpolation for table TBID in the strain rate direction.

***MAT_WINFRITH_CONCRETE**

This is Material Type 84 and Material Type 85, only the former of which includes rate effects. The Winfrith concrete model is a smeared crack (sometimes known as pseudo crack), smeared rebar model, implemented in the 8-node single integration point continuum element, i.e., ELFORM = 1 in *SECTION_SOLID. It is recommended that a double precision executable be used when using this material model. Single precision may produce unstable results.

This model was developed by Broadhouse and Neilson [1987], and Broadhouse [1995] over many years and has been validated against experiments. The input documentation given here is taken directly from the report by Broadhouse. The Fortran subroutines and quality assurance test problems were also provided to LSTC by the Winfrith Technology Center.

Rebar may be defined using the command *MAT_WINFRITH_CONCRETE_REINFORCEMENT which appears in the following section.

Card 1	1	2	3	4	5	6	7	8
Variable	MID	RO	TM	PR	UCS	UTS	FE	ASIZE
Type	A8	F	F	F	F	F	F	F

Card 2	1	2	3	4	5	6	7	8
Variable	E	YS	EH	UELONG	RATE	CONM	CONL	CONT
Type	F	F	F	F	F	F	F	F

Card 3	1	2	3	4	5	6	7	8
Variable	EPS1	EPS2	EPS3	EPS4	EPS5	EPS6	EPS7	EPS8
Type	F	F	F	F	F	F	F	F

Card 4	1	2	3	4	5	6	7	8
Variable	P1	P2	P3	P4	P5	P6	P7	P8
Type	F	F	F	F	F	F	F	F

VARIABLE

DESCRIPTION

MID	Material identification. A unique number or label not exceeding 8 characters must be specified.
RO	Mass density.
TM	Initial tangent modulus of concrete.
PR	Poisson's ratio.
UCS	Uniaxial compressive strength.
UTS	Uniaxial tensile strength.
FE	Depends on value of RATE below. RATE.EQ.0: Fracture energy (energy per unit area dissipated in opening crack). RATE.EQ.1: Crack width at which crack-normal tensile stress goes to zero.
ASIZE	Aggregate size (radius).
E	Young's modulus of rebar.
YS	Yield stress of rebar.
EH	Hardening modulus of rebar
UEONG	Ultimate elongation before rebar fails.
RATE	Rate effects: EQ.0.0: strain rate effects are included (mat 84 – may not conserve energy). EQ.1.0: strain rate effects are turned off (mat 85).

VARIABLE	DESCRIPTION
CONM	GT.0: Factor to convert model mass units to kg. EQ.-1.: Mass, length, time units in model are lbf × sec ² /in, inch, sec. EQ.-2.: Mass, length, time units in model are g, cm, microsec. EQ.-3.: Mass, length, time units in model are g, mm, msec. EQ.-4.: Mass, length, time units in model are metric ton, mm, sec. EQ.-5.: Mass, length, time units in model are kg, mm, msec.
CONL	If CONM.GT.0, factor to convert model length units to meters; otherwise CONL is ignored.
CONT	If CONM.GT.0, factor to convert model time units to seconds; otherwise CONT is ignored.
EPS1, EPS2, ...	Volumetric strain values (natural logarithmic values), see Remarks below. A maximum of 8 values are allowed.
P1, P2, ...	Pressures corresponding to volumetric strain values given on Card 3.

Remarks:

Pressure is positive in compression; volumetric strain is given by the natural log of the relative volume and is negative in compression. The tabulated data are given in order of increasing compression, with no initial zero point.

If the volume compaction curve is omitted, the following scaled curve is automatically used where p_1 is the pressure at uniaxial compressive failure from:

$$p_1 = \frac{\sigma_c}{3}$$

and K is the bulk unloading modulus computed from

$$K = \frac{E_s}{3(1 - 2\nu)}$$

where E_s is the input tangent modulus for concrete and ν is Poisson's ratio.

Volumetric Strain	Pressure
$-p_1/K$	$1.00xp_1$
-0.002	$1.50xp_1$
-0.004	$3.00xp_1$
-0.010	$4.80xp_1$
-0.020	$6.00xp_1$
-0.030	$7.50xp_1$
-0.041	$9.45xp_1$
-0.051	$11.55xp_1$
-0.062	$14.25xp_1$
-0.094	$25.05xp_1$

Table 2-57. Default pressure versus volumetric strain curve for concrete if the curve is not defined.

The Winfrith concrete model can generate an additional binary output database containing information on crack locations, directions, and widths. In order to generate the crack database, the LS-DYNA execution line is modified by adding:

$$q=crf$$

where *crf* is the desired name of the crack database, e.g., **q=d3crk**.

LS-PrePost can display the cracks on the deformed mesh plots. To do so, read the *d3plot* database into LS-PrePost and then select File → Open → Crack from the top menu bar. Or, open the crack database by adding the following to the LS-PrePost execution line:

$$q=crf$$

where *crf* is the name of the crack database, e.g., **q=d3crk**.

By default, all the cracks in visible elements are shown. You can eliminate narrow cracks from the display by setting a minimum crack width for displayed cracks. Do this by choosing Setting > Concrete Crack Width. From the top menu bar of LS-PrePost, choosing Misc > Model Info will reveal the number of cracked elements and the maximum crack width in a given plot state.

An ASCII “*aea_crack*” output file is written if the command *DATABASE_BINARY_D3CRACK command is included in the input deck. This command does not have any bearing on the aforementioned binary crack database.

***MAT_WINFRITH_CONCRETE_REINFORCEMENT**

This is Material Type 84 rebar reinforcement. Reinforcement may be defined in specific groups of elements, but it is usually more convenient to define a two-dimensional mat in a specified layer of a specified material. Reinforcement quantity is defined as the ratio of the cross-sectional area of steel relative to the cross-sectional area of concrete in the element (or layer). These cards may follow either one of two formats below and may also be defined in any order.

Option 1 (Reinforcement quantities in element groups).

Card 1	1	2	3	4	5	6	7	8
Variable	EID1	EID2	INC	XR	YR	ZR		
Type	I	I	I	F	F	F		

Option 2 (Two dimensional layers by part ID). Option 2 is active when first entry is left blank.

Card 1	1	2	3	4	5	6	7	8
Variable		PID	AXIS	COOR	RQA	RQB		
Type	blank	I	I	F	F	F		

VARIABLE**DESCRIPTION**

EID1	First element ID in group.
EID2	Last element ID in group
INC	Element increment for generation.
XR	X-reinforcement quantity (for bars running parallel to global x-axis).
YR	Y-reinforcement quantity (for bars running parallel to global y-axis).
ZR	Z-reinforcement quantity (for bars running parallel to global z-axis).
PID	Part ID of reinforced elements.

VARIABLE	DESCRIPTION
AXIS	Axis normal to layer. EQ.1: A and B are parallel to global Y and Z, respectively. EQ.2: A and B are parallel to global X and Z, respectively. EQ.3: A and B are parallel to global X and Y, respectively.
COOR	Coordinate location of layer: AXIS.EQ.1: X-coordinate AXIS.EQ.2: Y-coordinate AXIS.EQ.3: Z-coordinate
RQA	Reinforcement quantity (A).
RQB	Reinforcement quantity (B).

Remarks:

1. Reinforcement quantity is the ratio of area of reinforcement in an element to the element's total cross-sectional area in a given direction. This definition is true for both Options 1 and 2. Where the options differ is in the manner in which it is decided which elements are reinforced. In Option 1, the reinforced element IDs are spelled out. In Option 2, elements of part ID PID which are cut by a plane (layer) defined by AXIS and COOR are reinforced.

***MAT_ORTHOTROPIC_VISCOELASTIC**

This is Material Type 86. It allows the definition of an orthotropic material with a viscoelastic part. This model applies to shell elements.

Card 1	1	2	3	4	5	6	7	8
Variable	MID	RO	EA	EB	EC	VF	K	
Type	A8	F	F	F	F	F	F	

Card 2	1	2	3	4	5	6	7	8
Variable	G0	GINF	BETA	PRBA	PRCA	PRCB		
Type	F	F	F	F	F	F		

Card 3	1	2	3	4	5	6	7	8
Variable	GAB	GBC	GCA	AOPT	MANGLE			
Type	F	F	F	F	F			

Card 4	1	2	3	4	5	6	7	8
Variable				A1	A2	A3		
Type				F	F	F		

Card 5	1	2	3	4	5	6	7	8
Variable	V1	V2	V3	D1	D2	D3		
Type	F	F	F	F	F	F		

VARIABLE	DESCRIPTION
MID	Material identification. A unique number or label not exceeding 8 characters must be specified.
RO	Mass density
EA	Young's Modulus E_a
EB	Young's Modulus E_b
EC	Young's Modulus E_c
VF	Volume fraction of viscoelastic material
K	Elastic bulk modulus
G0	G_0 , short-time shear modulus
GINF	G_∞ , long-time shear modulus
BETA	β , decay constant
PRBA	Poisson's ratio, ν_{ba}
PRCA	Poisson's ratio, ν_{ca}
PRCB	Poisson's ratio, ν_{cb}
GAB	Shear modulus, G_{ab}
GBC	Shear modulus, G_{bc}
GCA	Shear modulus, G_{ca}
AOPT	Material axes option (see <code>MAT_OPTIONTROPIC_ELASTIC</code> for a more complete description): <ul style="list-style-type: none"> EQ.0.0: locally orthotropic with material axes determined by element nodes 1, 2, and 4, as with <code>*DEFINE_COORDINATE_NODES</code>, and then rotated about the shell element normal by an angle <code>MANGLE</code>. EQ.2.0: globally orthotropic with material axes determined by vectors defined below, as with <code>*DEFINE_COORDINATE_VECTOR</code>. EQ.3.0: locally orthotropic material axes determined by rotating the material axes about the element normal by an angle,

VARIABLE	DESCRIPTION
	MANGLE, from a line in the plane of the element defined by the cross product of the vector \mathbf{v} with the element normal.
	LT.0.0: the absolute value of AOPT is a coordinate system ID number (CID on *DEFINE_COORDINATE_NODES, *DEFINE_COORDINATE_SYSTEM or *DEFINE_COORDINATE_VECTOR). Available in R3 version of 971 and later.
MANGLE	Material angle in degrees for AOPT = 0 and 3, may be overridden on the element card, see *ELEMENT_SHELL_BETA.
A1 A2 A3	Define components of vector \mathbf{a} for AOPT = 2.
V1 V2 V3	Define components of vector \mathbf{v} for AOPT = 3.
D1 D2 D3	Define components of vector \mathbf{d} for AOPT = 2.

Remarks:

For the orthotropic definition it is referred to Material Type 2 and 21.

*MAT_CELLULAR_RUBBER

This is Material Type 87. This material model provides a cellular rubber model with confined air pressure combined with linear viscoelasticity as outlined by Christensen [1980]. See [Figure 2-58](#).

Card 1	1	2	3	4	5	6	7	8
Variable	MID	RO	PR	N				
Type	A8	F	F	I				

Card 2 if N > 0, a least squares fit is computed from uniaxial data

Card 2	1	2	3	4	5	6	7	8
Variable	SGL	SW	ST	LCID				
Type	F	F	F	F				

Card 2 if N = 0, define the following constants

Card 2	1	2	3	4	5	6	7	8
Variable	C10	C01	C11	C20	C02			
Type	F	F	F	F	F			

Card 3	1	2	3	4	5	6	7	8
Variable	P0	PHI	IVS	G	BETA			
Type	F	F	F	F	F			

VARIABLE

DESCRIPTION

MID	Material identification. A unique number or label not exceeding 8 characters must be specified.
RO	Mass density

VARIABLE	DESCRIPTION
PR	Poisson's ratio, typical values are between .0 to .2. Due to the large compressibility of air, large values of Poisson's ratio generates physically meaningless results.
N	Order of fit (currently < 3). If $n > 0$ then a least square fit is computed with uniaxial data. The parameters given on card 2 should be specified. Also see *MAT_MOONEY_RIVLIN_RUBBER (material model 27). A Poisson's ratio of .5 is assumed for the void free rubber during the fit. The Poisson's ratio defined on Card 1 is for the cellular rubber. A void fraction formulation is used.
Define, if N > 0:	
SGL	Specimen gauge length l_0
SW	Specimen width
ST	Specimen thickness
LCID	Load curve ID giving the force versus actual change ΔL in the gauge length.
Define, if N = 0:	
C10	Coefficient, C_{10}
C01	Coefficient, C_{01}
C11	Coefficient, C_{11}
C20	Coefficient, C_{20}
C02	Coefficient, C_{02}
P0	Initial air pressure, P_0
PHI	Ratio of cellular rubber to rubber density, Φ
IVS	Initial volumetric strain, γ_0
G	Optional shear relaxation modulus, G , for rate effects (viscosity)
BETA	Optional decay constant, β_1

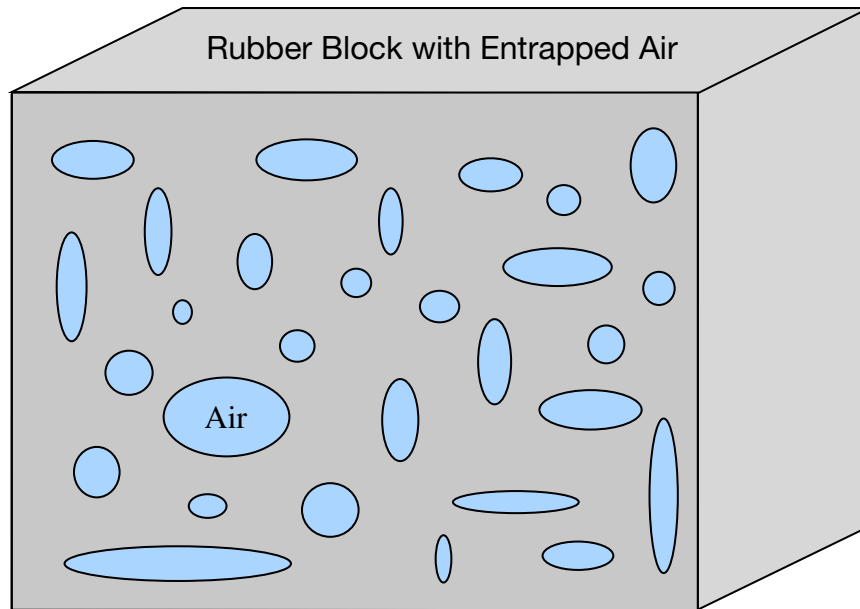

Figure 2-58. Cellular rubber with entrapped air. By setting the initial air pressure to zero, an open cell, cellular rubber can be simulated.

Remarks:

Rubber is generally considered to be fully incompressible since the bulk modulus greatly exceeds the shear modulus in magnitude. To model the rubber as an unconstrained material a hydrostatic work term, $W_H(J)$, is included in the strain energy functional which is function of the relative volume, J , [Ogden 1984]:

$$W(J_1, J_2, J) = \sum_{p,q=0}^n C_{pq} (J_1 - 3)^p (J_2 - 3)^q + W_H(J)$$

$$J_1 + I_1 I_3^{-1/3}$$

$$J_2 + I_2 I_3^{-2/3}$$

In order to prevent volumetric work from contributing to the hydrostatic work the first and second invariants are modified as shown. This procedure is described in more detail by Sussman and Bathe [1987].

The effects of confined air pressure in its overall response characteristics is included by augmenting the stress state within the element by the air pressure.

$$\sigma_{ij} = \sigma_{ij}^{sk} - \delta_{ij} \sigma^{air}$$

where σ_{ij}^{sk} is the bulk skeletal stress and σ^{air} is the air pressure computed from the equation:

$$\sigma^{\text{air}} = -\frac{p_0\gamma}{1 + \gamma - \phi}$$

where p_0 is the initial foam pressure usually taken as the atmospheric pressure and γ defines the volumetric strain

$$\gamma = V - 1 + \gamma_0$$

where V is the relative volume of the voids and γ_0 is the initial volumetric strain which is typically zero. The rubber skeletal material is assumed to be incompressible.

Rate effects are taken into account through linear viscoelasticity by a convolution integral of the form:

$$\sigma_{ij} = \int_0^t g_{ijkl}(t - \tau) \frac{\partial \varepsilon_{kl}}{\partial \tau} d\tau$$

or in terms of the second Piola-Kirchhoff stress, S_{ij} , and Green's strain tensor, E_{ij} ,

$$S_{ij} = \int_0^t G_{ijkl}(t - \tau) \frac{\partial \varepsilon_{kl}}{\partial \tau} d\tau$$

where $g_{ijkl}(t - \tau)$ and $G_{ijkl}(t - \tau)$ are the relaxation functions for the different stress measures. This stress is added to the stress tensor determined from the strain energy functional.

Since we wish to include only simple rate effects, the relaxation function is represented by one term from the Prony series:

$$g(t) = \alpha_0 + \sum_{m=1}^N \alpha_m e^{-\beta t}$$

given by,

$$g(t) = E_d e^{-\beta_1 t}.$$

This model is effectively a Maxwell fluid which consists of a damper and spring in series. We characterize this in the input by a shear modulus, G , and decay constant, β_1 .

The Mooney-Rivlin rubber model (model 27) is obtained by specifying $n = 1$ without air pressure and viscosity. In spite of the differences in formulations with Model 27, we find that the results obtained with this model are nearly identical with those of material type 27 as long as large values of Poisson's ratio are used.

*MAT_MTS

This is Material Type 88. The MTS model is due to Mauldin, Davidson, and Henninger [1990] and is available for applications involving large strains, high pressures and strain rates. As described in the foregoing reference, this model is based on dislocation mechanics and provides a better understanding of the plastic deformation process for ductile materials by using an internal state variable call the mechanical threshold stress. This kinematic quantity tracks the evolution of the material’s microstructure along some arbitrary strain, strain rate, and temperature-dependent path using a differential form that balances dislocation generation and recovery processes. Given a value for the mechanical threshold stress, the flow stress is determined using either a thermal-activation-controlled or a drag-controlled kinetics relationship. An equation-of-state is required for solid elements and a bulk modulus must be defined below for shell elements.

Card 1	1	2	3	4	5	6	7	8
Variable	MID	RO	SIGA	SIGI	SIGS	SIGO	BULK	
Type	A8	F	F	F	F	F	F	

Card 2	1	2	3	4	5	6	7	8
Variable	HF0	HF1	HF2	SIGS0	EDOTS0	BURG	CAPA	BOLTZ
Type	F	F	F	F	F	F	F	F

Card 3	1	2	3	4	5	6	7	8
Variable	SM0	SM1	SM2	EDOT0	GO	PINV	QINV	EDOTI
Type	F	F	F	F	F	F	F	F

Card 4	1	2	3	4	5	6	7	8
Variable	G0I	PINVI	QINVI	EDOTS	G0S	PINVS	QINVS	
Type	F	F	F	F	F	F	F	

Card 5	1	2	3	4	5	6	7	8
Variable	RHOCPR	TEMPRF	ALPHA	EPS0				
Type	F	F						

VARIABLE**DESCRIPTION**

MID	Material identification. A unique number or label not exceeding 8 characters must be specified.
RO	Mass density
SIGA	$\hat{\sigma}_a$, dislocation interactions with long-range barriers (force/area).
SIGI	$\hat{\sigma}_i$, dislocation interactions with interstitial atoms (force/area).
SIGS	$\hat{\sigma}_s$, dislocation interactions with solute atoms (force/area).
SIG0	$\hat{\sigma}_0$, initial value of $\hat{\sigma}$ at zero plastic strain (force/area) NOT USED.
HF0	a_0 , dislocation generation material constant (force/area).
HF1	a_1 , dislocation generation material constant (force/area).
HF2	a_2 , dislocation generation material constant (force/area).
SIGS0	$\hat{\sigma}_{\text{ES0}}$, saturation threshold stress at 0° K (force/area).
BULK	Bulk modulus defined for shell elements only. Do not input for solid elements.
EDOTS0	$\dot{\epsilon}_{\text{ES0}}$, reference strain-rate (time ⁻¹).
BURG	Magnitude of Burgers vector (interatomic slip distance), (distance)
CAPA	Material constant, A.
BOLTZ	Boltzmann's constant, k (energy/degree).
SM0	G_0 , shear modulus at zero degrees Kelvin (force/area).
SM1	b_1 , shear modulus constant (force/area).
SM2	b_2 , shear modulus constant (degree).

VARIABLE	DESCRIPTION
EDOT0	$\dot{\varepsilon}_{o,r}$, reference strain-rate (time ⁻¹).
G0	$g_{0,r}$, normalized activation energy for a dislocation/dislocation interaction.
PINV	$\frac{1}{p'}$, material constant.
QINV	$\frac{1}{q'}$, material constant.
EDOTI	$\dot{\varepsilon}_{o,i}$, reference strain-rate (time ⁻¹).
G0I	$g_{0,i}$, normalized activation energy for a dislocation/interstitial interaction.
PINVI	$\frac{1}{p'_i}$, material constant.
QINVI	$\frac{1}{q'_i}$, material constant.
EDOTS	$\dot{\varepsilon}_{o,s}$, reference strain-rate (time ⁻¹).
G0S	$g_{0,s}$, normalized activation energy for a dislocation/solute interaction.
PINVS	$\frac{1}{p'_s}$, material constant.
QINVS	$\frac{1}{q'_s}$, material constant.
RHOCPR	ρc_p , product of density and specific heat.
TEMPRF	T_{ref} , initial element temperature in degrees K.
ALPHA	α , material constant (typical value is between 0 and 2).
EPS0	ε_o , factor to normalize strain rate in the calculation of Θ_o . (time ⁻¹).

Remarks:

The flow stress σ is given by:

$$\sigma = \hat{\sigma}_a + \frac{G}{G_0} [s_{\text{th}} \hat{\sigma} + s_{\text{th},i} \hat{\sigma}_i + s_{\text{th},s} \hat{\sigma}_s]$$

The first product in the equation for τ contains a micro-structure evolution variable, i.e., $\hat{\sigma}$, called the *Mechanical Threshold Stress* (MTS), that is multiplied by a constant-structure

deformation variable s_{th} : s_{th} is a function of absolute temperature T and the plastic strain-rates $\dot{\epsilon}^p$. The evolution equation for $\hat{\sigma}$ is a differential hardening law representing dislocation-dislocation interactions:

$$\frac{\partial}{\partial \epsilon^p} \equiv \Theta_o \left[1 - \frac{\tanh\left(\alpha \frac{\hat{\sigma}}{\hat{\sigma}_{\epsilon s}}\right)}{\tanh(\alpha)} \right]$$

The term, $\frac{\partial \hat{\sigma}}{\partial \epsilon^p}$, represents the hardening due to dislocation generation and the stress ratio, $\frac{\hat{\sigma}}{\hat{\sigma}_{\epsilon s}}$, represents softening due to dislocation recovery. The threshold stress at zero strain-hardening $\hat{\sigma}_{\epsilon s}$ is called the saturation threshold stress. Relationships for Θ_o , $\hat{\sigma}_{\epsilon s}$ are:

$$\Theta_o = a_o + a_1 \ln\left(\frac{\dot{\epsilon}^p}{\epsilon_0}\right) + a_2 \sqrt{\frac{\dot{\epsilon}^p}{\epsilon_0}}$$

which contains the material constants, a_o , a_1 , and a_2 . The constant, $\hat{\sigma}_{\epsilon s}$, is given as:

$$\hat{\sigma}_{\epsilon s} = \hat{\sigma}_{\epsilon s0} \left(\frac{\dot{\epsilon}^p}{\dot{\epsilon}_{\epsilon s0}}\right)^{kT/Gb^3A}$$

which contains the input constants: $\hat{\sigma}_{\epsilon s0}$, $\dot{\epsilon}_{\epsilon s0}$, b , A , and k . The shear modulus G appearing in these equations is assumed to be a function of temperature and is given by the correlation.

$$G = G_0 - b_1 / (e^{b_2/T} - 1)$$

which contains the constants: G_0 , b_1 , and b_2 . For thermal-activation controlled deformation s_{th} is evaluated via an Arrhenius rate equation of the form:

$$s_{th} = \left\{ 1 - \left[\frac{kT \ln\left(\frac{\dot{\epsilon}_0}{\dot{\epsilon}^p}\right)}{Gb^3 g_0} \right]^{\frac{1}{q}} \right\}^{\frac{1}{p}}$$

The absolute temperature is given as:

$$T = T_{ref} + \frac{E}{\rho c_p}$$

where E is the internal energy density per unit initial volume.

*MAT_PLASTICITY_POLYMER

This is Material Type 89. An elasto-plastic material with an arbitrary stress versus strain curve and arbitrary strain rate dependency can be defined. It is intended for applications where the elastic and plastic sections of the response are not as clearly distinguishable as they are for metals. Rate dependency of failure strain is included. Many polymers show a more brittle response at high rates of strain.

Card 1	1	2	3	4	5	6	7	8
Variable	MID	RO	E	PR				
Type	A8	F	F	F				
Default	none	none	none	none				

Card 2	1	2	3	4	5	6	7	8
Variable	C	P	LCSS	LCSR				
Type	F	F	F	F				
Default	0	0	0	0				

Card 3	1	2	3	4	5	6	7	8
Variable	EFTX	DAMP	RFAC	LCFAIL				
Type	F	F	F	F				
Default	0	0	0	0				

VARIABLE

DESCRIPTION

MID	Material identification. A unique number or label not exceeding 8 characters must be specified.
RO	Mass density.

VARIABLE	DESCRIPTION
E	Young's modulus.
PR	Poisson's ratio.
C	Strain rate parameter, C, (Cowper Symonds).
P	Strain rate parameter, P, (Cowper Symonds).
LCSS	Load curve ID or Table ID. Load curve ID defining effective stress versus total effective strain. The table ID defines for each strain rate value a load curve ID giving the stress versus total effective strain for that rate. NOTE: The strain rate values defined in the table may be given as the natural logarithm of the strain rate. If the first stress-strain curve in the table corresponds to a negative strain rate, LS-DYNA assumes that the natural logarithm of the strain rate value is used. Since the tables are internally discretized to equally space the points, natural logarithms are necessary, for example, if the curves correspond to rates from 10.e-04 to 10.e+04.
LCSR	Load curve ID defining strain rate scaling effect on yield stress. If LCSR is negative, the load curve is evaluated using a binary search for the correct interval for the strain rate. The binary search is slower than the default incremental search, but in cases where large changes in the strain rate may occur over a single time step, it is more robust.
EFTX	Failure flag. EQ.0.0: failure determined by maximum tensile strain (default), EQ.1.0: failure determined only by tensile strain in local x direction, EQ.2.0: failure determined only by tensile strain in local y direction.
DAMP	Stiffness-proportional damping ratio. Typical values are 1e-3 or 1e-4. If set too high instabilities can result.
RFAC	Filtering factor for strain rate effects. Must be between 0 (no filtering) and 1 (infinite filtering). The filter is a simple low pass filter to remove high frequency oscillation from the strain rates before they are used in rate effect calculations. The cut off frequency of the filter is $[(1 - RFAC) / \text{timestep}]$ rad/sec.

VARIABLE	DESCRIPTION
LCFAIL	Load curve ID giving variation of failure strain with strain rate. The points on the x-axis should be natural log of strain rate, the y-axis should be the true strain to failure. Typically this is measured by uniaxial tensile test, and the strain values converted to true strain.

Remarks:

1. Unlike other LS-DYNA material models, both the input stress-strain curve and the strain to failure are defined as total true strain, not plastic strain. The input can be defined from uniaxial tensile tests; nominal stress and nominal strain from the tests must be converted to true stress and true strain. The elastic component of strain must not be subtracted out.
2. The stress-strain curve is permitted to have sections steeper (i.e. stiffer) than the elastic modulus. When these are encountered the elastic modulus is increased to prevent spurious energy generation.
3. Sixty-four bit precision is recommended when using this material model, especially if the strains become high.
4. Invariant shell numbering is recommended when using this material model. See *CONTROL_ACCURACY.
5. Damage in the material begins when the “failure strain” is reached, i.e., when extra history variable 8 reaches a value of 1.0. The element is then progressively softened via a damage model until history variable 8 reaches a value of 1.1 at which point the element is deleted. In other words, the element is deleted at 1.1 times the failure strain.

***MAT_ACOUSTIC**

This is Material Type 90. This model is appropriate for tracking low pressure stress waves in an acoustic media such as air or water and can be used only with the acoustic pressure element formulation. The acoustic pressure element requires only one unknown per node. This element is very cost effective. Optionally, cavitation can be allowed.

Card 1	1	2	3	4	5	6	7	8
Variable	MID	RO	C	BETA	CF	ATMOS	GRAV	
Type	A8	F	F	F	F	F	F	

Card 2	1	2	3	4	5	6	7	8
Variable	XP	YP	ZP	XN	YN	ZN		
Type	F	F	F	F	F	F		

VARIABLE**DESCRIPTION**

MID	Material identification. A unique number or label not exceeding 8 characters must be specified.
RO	Mass density
C	Sound speed
BETA	Damping factor. Recommend values are between 0.1 and 1.0.
CF	Cavitation flag: EQ.0.0: off, EQ.1.0: on.
ATMOS	Atmospheric pressure (optional)
GRAV	Gravitational acceleration constant (optional)
XP	x-coordinate of free surface point
YP	y-coordinate of free surface point

VARIABLE	DESCRIPTION
ZP	z-coordinate of free surface point
XN	x-direction cosine of free surface normal vector
YN	y-direction cosine of free surface normal vector
ZN	z-direction cosine of free surface normal vector

***MAT_SOFT_TISSUE_{OPTION}**

Available options include:

<BLANK>

VISCO

This is Material Type 91 (*OPTION*=<BLANK>) or Material Type 92 (*OPTION* = VISCO). This material is a transversely isotropic hyperelastic model for representing biological soft tissues such as ligaments, tendons, and fascia. The representation provides an isotropic Mooney-Rivlin matrix reinforced by fibers having a strain energy contribution with the qualitative material behavior of collagen. The model has a viscoelasticity option which activates a six-term Prony series kernel for the relaxation function. In this case, the hyperelastic strain energy represents the elastic (long-time) response. See Weiss et al. [1996] and Puso and Weiss [1998] for additional details. The material is available for use with brick and shell elements. When used with shell elements, the Belytschko-Tsay formulation (#2) must be selected.

Card 1	1	2	3	4	5	6	7	8
Variable	MID	RO	C1	C2	C3	C4	C5	
Type	A8	F	F	F	F	F	F	

Card 2	1	2	3	4	5	6	7	8
Variable	XK	XLAM	FANG	XLAMO	FAILSF	FAILSM	FAILSHR	
Type	F	F	F	F	F	F	F	

Card 3	1	2	3	4	5	6	7	8
Variable	AOPT	AX	AY	AZ	BX	BY	BZ	
Type	F	F	F	F	F	F	F	

Card 4	1	2	3	4	5	6	7	8
Variable	LA1	LA2	LA3	MACF				
Type	F	F	F	I				

Prony Series Card 1. Additional card for VISCO keyword option.

Card 5	1	2	3	4	5	6	7	8
Variable	S1	S2	S3	S4	S5	S6		
Type	F	F	F	F	F	F		

Prony Series Card 2. Additional card for VISCO keyword option.

Card 6	1	2	3	4	5	6	7	8
Variable	T1	T2	T3	T4	T5	T6		
Type	F	F	F	F	F	F		

VARIABLE	DESCRIPTION
MID	Material identification. A unique number or label not exceeding 8 characters must be specified.
RO	Mass density
C1 - C5	Hyperelastic coefficients (see equations below)
XK	Bulk Modulus
XLAM	Stretch ratio at which fibers are straightened
FANG	Fiber angle in local shell coordinate system (shells only)
XLAM0	Initial fiber stretch (optional)
FAILSF	Stretch ratio for ligament fibers at failure (applies to shell elements only). If zero, failure is not considered.

VARIABLE	DESCRIPTION
FAILSM	Stretch ratio for surrounding matrix material at failure (applies to shell elements only). If zero, failure is not considered.
FAILSHR	Shear strain at failure at a material point (applies to shell elements only). If zero, failure is not considered. This failure value is independent of FAILSF and FAILSM.
AOPT	<p>Material axes option, see Figure 2-3 (bricks only):</p> <p>EQ.0.0: locally orthotropic with material axes determined by element nodes as shown in Figure 2-3. Nodes 1, 2, and 4 of an element are identical to the nodes used for the definition of a coordinate system as by *DEFINE_COORDINATE_NODES.</p> <p>EQ.1.0: locally orthotropic with material axes determined by a point in space and the global location of the element center; this is the a-direction. This option is for solid elements only.</p> <p>EQ.2.0: globally orthotropic with material axes determined by vectors defined below, as with *DEFINE_COORDINATE_VECTOR.</p> <p>EQ.3.0: locally orthotropic material axes determined by a line in the plane of the element defined by the cross product of the vector v with the element normal. The plane of a solid element is the midsurface between the inner surface and outer surface defined by the first four nodes and the last four nodes of the connectivity of the element, respectively.</p> <p>EQ.4.0: locally orthotropic in cylindrical coordinate system with the material axes determined by a vector v, and an originating point, P, which define the centerline axis. This option is for solid elements only.</p> <p>LT.0.0: the absolute value of AOPT is a coordinate system ID number (CID on *DEFINE_COORDINATE_NODES, *DEFINE_COORDINATE_SYSTEM or *DEFINE_COORDINATE_VECTOR). Available in R3 version of 971 and later.</p>
AX, AY, AZ	<p>Equal to X_P, Y_P, Z_P for AOPT = 1, Equal to A_1, A_2, A_3 for AOPT = 2, Equal to V_1, V_2, V_3 for AOPT = 3 or 4.</p>

VARIABLE	DESCRIPTION
BX, BY, BZ	Equal to D1,D2,D3 for AOPT = 2 Equal to XP,YP,ZP for AOPT = 4
LAX, LAY, LAZ	Local fiber orientation vector (bricks only)
MACF	Material axes change flag for brick elements: EQ.1: No change, default, EQ.2: switch material axes a and b, EQ.3: switch material axes a and c, EQ.4: switch material axes b and c.
S1 – S6	Factors in the Prony series.
T1 - T6	Characteristic times for Prony series relaxation kernel (OPTION = VISCO)

Remarks:

The overall strain energy W is "uncoupled" and includes two isotropic deviatoric matrix terms, a fiber term F , and a bulk term:

$$W = C_1(\tilde{I}_1 - 3) + C_2(\tilde{I}_2 - 3) + F(\lambda) + \frac{1}{2}K[\ln(J)]^2$$

Here, \tilde{I}_1 and \tilde{I}_2 are the deviatoric invariants of the right Cauchy deformation tensor, λ is the deviatoric part of the stretch along the current fiber direction, and $J = \det F$ is the volume ratio. The material coefficients C_1 and C_2 are the Mooney-Rivlin coefficients, while K is the effective bulk modulus of the material (input parameter XK).

The derivatives of the fiber term F are defined to capture the behavior of crimped collagen. The fibers are assumed to be unable to resist compressive loading - thus the model is isotropic when $\lambda < 1$. An exponential function describes the straightening of the fibers, while a linear function describes the behavior of the fibers once they are straightened past a critical fiber stretch level $\lambda \geq \lambda^*$ (input parameter XLAM):

$$\frac{\partial F}{\partial \lambda} = \begin{cases} 0 & \lambda < 1 \\ \frac{C_3}{\lambda} [\exp(C_4(\lambda - 1)) - 1] & \lambda < \lambda^* \\ \frac{1}{\lambda} (C_5\lambda + C_6) & \lambda \geq \lambda^* \end{cases}$$

Coefficients C_3 , C_4 , and C_5 must be defined by the user. C_6 is determined by LS-DYNA to ensure stress continuity at $\lambda = \lambda^*$. Sample values for the material coefficients $C_1 - C_5$ and

λ^* for ligament tissue can be found in Quapp and Weiss [1998]. The bulk modulus K should be at least 3 orders of magnitude larger than C_1 to ensure near-incompressible material behavior.

Viscoelasticity is included via a convolution integral representation for the time-dependent second Piola-Kirchoff stress $\mathbf{S}(\mathbf{C}, t)$:

$$\mathbf{S}(\mathbf{C}, t) = \mathbf{S}^e(\mathbf{C}) + \int_0^t 2G(t-s) \frac{\partial W}{\partial \mathbf{C}(s)} ds$$

Here, \mathbf{S}^e is the elastic part of the second PK stress as derived from the strain energy, and $G(t-s)$ is the reduced relaxation function, represented by a Prony series:

$$G(t) = \sum_{i=1}^6 S_i \exp\left(-\frac{t}{T_i}\right)$$

Puso and Weiss [1998] describe a graphical method to fit the Prony series coefficients to relaxation data that approximates the behavior of the continuous relaxation function proposed by Y-C. Fung, as quasilinear viscoelasticity.

Remarks on Input Parameters:

Cards 1 through 4 must be included for both shell and brick elements, although for shells cards 3 and 4 are ignored and may be blank lines.

For shell elements, the fiber direction lies in the plane of the element. The local axis is defined by a vector between nodes n1 and n2, and the fiber direction may be offset from this axis by an angle FANG.

For brick elements, the local coordinate system is defined using the convention described previously for *MAT_ORTHOTROPIC_ELASTIC. The fiber direction is oriented in the local system using input parameters LAX, LAY, and LAZ. By default, (LAX,LAY,LAZ) = (1,0,0) and the fiber is aligned with the local x-direction.

An optional initial fiber stretch can be specified using XLAM0. The initial stretch is applied during the first time step. This creates preload in the model as soft tissue contacts and equilibrium is established. For example, a ligament tissue "uncrimping strain" of 3% can be represented with initial stretch value of 1.03.

If the **VISCO** option is selected, at least one Prony series term (S1,T1) must be defined.

***MAT_ELASTIC_6DOF_SPRING_DISCRETE_BEAM**

This is Material Type 93. This material model is defined for simulating the effects of non-linear elastic and nonlinear viscous beams by using six springs each acting about one of the six local degrees-of-freedom. The input consists of part ID's that reference material type, *MAT_ELASTIC_SPRING_DISCRETE_BEAM above (type 74 above). Generally, these referenced parts are used only for the definition of this material model and are not referenced by any elements. The two nodes defining a beam may be coincident to give a zero length beam, or offset to give a finite length beam. For finite length discrete beams the absolute value of the variable SCOR in the SECTION_BEAM input should be set to a value of 2.0, which causes the local r-axis to be aligned along the two nodes of the beam to give physically correct behavior. The distance between the nodes of a beam should not affect the behavior of this material model. A triad is used to orient the beam for the directional springs.

Card 1	1	2	3	4	5	6	7	8
Variable	MID	RO	TPIDR	TPIDS	TPIDT	RPIDR	RPIDS	RPIDT
Type	A8	F	I	I	I	I	I	I

VARIABLE**DESCRIPTION**

MID	Material identification. A unique number or label not exceeding 8 characters must be specified.
RO	Mass density, see also volume in *SECTION_BEAM definition.
TPIDR	Translational motion in the local r-direction is governed by part ID TPIDR. If zero, no force is computed in this direction.
TPIDS	Translational motion in the local s-direction is governed by part ID TPIDS. If zero, no force is computed in this direction.
TPIDT	Translational motion in the local t-direction is governed by part ID TPIDT. If zero, no force is computed in this direction.
RPIDR	Rotational motion about the local r-axis is governed by part ID RPIDR. If zero, no moment is computed about this axis.
RPIDS	Rotational motion about the local s-axis is governed by part ID RPIDS. If zero, no moment is computed about this axis.

VARIABLE	DESCRIPTION
RPIDT	Rotational motion about the local t-axis is governed by part ID RPIDT. If zero, no moment is computed about this axis.

***MAT_INELASTIC_SPRING_DISCRETE_BEAM**

This is Material Type 94. This model permits elastoplastic springs with damping to be represented with a discrete beam element type 6. A yield force versus deflection curve is used which can vary in tension and compression.

Card 1	1	2	3	4	5	6	7	8
Variable	MID	RO	K	F0	D	CDF	TDF	
Type	A8	F	F	F	F	F	F	

Card 2	1	2	3	4	5	6	7	8
Variable	FLCID	HLCID	C1	C2	DLE	GLCID		
Type	F	F	F	F	F	I		

VARIABLE	DESCRIPTION
MID	Material identification. A unique number or label not exceeding 8 characters must be specified.
RO	Mass density, see also volume in *SECTION_BEAM definition.
K	Elastic loading/unloading stiffness. This is required input.
F0	Optional initial force. This option is inactive if this material is referenced in a part referenced by material type *MAT_INELASTIC_6D-OF_SPRING
D	Optional viscous damping coefficient.
CDF	Compressive displacement at failure. Input as a positive number. After failure, no forces are carried. This option does not apply to zero length springs. EQ.0.0: inactive.
TDF	Tensile displacement at failure. After failure, no forces are carried. EQ.0.0: inactive.

VARIABLE	DESCRIPTION
FLCID	Load curve ID, see *DEFINE_CURVE, defining the yield force versus plastic deflection. If the origin of the curve is at (0,0) the force magnitude is identical in tension and compression, i.e., only the sign changes. If not, the yield stress in the compression is used when the spring force is negative. The plastic displacement increases monotonically in this implementation. The load curve is required input.
HLCID	Load curve ID, see *DEFINE_CURVE, defining force versus relative velocity (Optional). If the origin of the curve is at (0,0) the force magnitude is identical for a given magnitude of the relative velocity, i.e., only the sign changes.
C1	Damping coefficient.
C2	Damping coefficient
DLE	Factor to scale time units.
GLCID	Optional load curve ID, see *DEFINE_CURVE, defining a scale factor versus deflection for load curve ID, HLCID. If zero, a scale factor of unity is assumed.

Remarks:

The yield force is taken from the load curve:

$$F^Y = F_y(\Delta L^{\text{plastic}})$$

where L^{plastic} is the plastic deflection. A trial force is computed as:

$$F^T = F^n + K \times \Delta \dot{L}(\Delta t)$$

and is checked against the yield force to determine F :

$$F = \begin{cases} F^Y & \text{if } F^T > F^Y \\ F^T & \text{if } F^T \leq F^Y \end{cases}$$

The final force, which includes rate effects and damping, is given by:

$$F^{n+1} = F \times \left[1 + C1 \times \Delta \dot{L} + C2 \times \text{sgn}(\Delta \dot{L}) \ln \left(\max \left\{ 1, \frac{|\Delta \dot{L}|}{\text{DLE}} \right\} \right) \right] + D \times \Delta \dot{L} + g(\Delta L)h(\Delta \dot{L})$$

Unless the origin of the curve starts at (0,0), the negative part of the curve is used when the spring force is negative where the negative of the plastic displacement is used to interpolate, F_y . The positive part of the curve is used whenever the force is positive. In these equations, ΔL is the change in length

$$\Delta L = \text{current length} - \text{initial length}$$

The cross sectional area is defined on the section card for the discrete beam elements, See *SECTION_BEAM. The square root of this area is used as the contact thickness offset if these elements are included in the contact treatment.

***MAT_INELASTIC_6DOF_SPRING_DISCRETE_BEAM**

This is Material Type 95. This material model is defined for simulating the effects of non-linear inelastic and nonlinear viscous beams by using six springs each acting about one of the six local degrees-of-freedom. The input consists of part ID's that reference material type, *MAT_INELASTIC_SPRING_DISCRETE_BEAM above (type 94). Generally, these referenced parts are used only for the definition of this material model and are not referenced by any elements. The two nodes defining a beam may be coincident to give a zero length beam, or offset to give a finite length beam. For finite length discrete beams the absolute value of the variable SCOR in the SECTION_BEAM input should be set to a value of 2.0, which causes the local r-axis to be aligned along the two nodes of the beam to give physically correct behavior. The distance between the nodes of a beam should not affect the behavior of this material model. A triad must be used to orient the beam for zero length beams.

Card 1	1	2	3	4	5	6	7	8
Variable	MID	RO	TPIDR	TPIDS	TPIDT	RPIDR	RPIDS	RPIDT
Type	A8	F	I	I	I	I	I	I

VARIABLE**DESCRIPTION**

MID	Material identification. A unique number or label not exceeding 8 characters must be specified.
RO	Mass density, see also volume in *SECTION_BEAM definition.
TPIDR	Translational motion in the local r-direction is governed by part ID TPIDR. If zero, no force is computed in this direction.
TPIDS	Translational motion in the local s-direction is governed by part ID TPIDS. If zero, no force is computed in this direction.
TPIDT	Translational motion in the local t-direction is governed by part ID TPIDT. If zero, no force is computed in this direction.
RPIDR	Rotational motion about the local r-axis is governed by part ID RPIDR. If zero, no moment is computed about this axis.
RPIDS	Rotational motion about the local s-axis is governed by part ID RPIDS. If zero, no moment is computed about this axis.

VARIABLE	DESCRIPTION
RPIDT	Rotational motion about the local t-axis is governed by part ID RPIDT. If zero, no moment is computed about this axis.

***MAT_BRITTLE_DAMAGE**

This is Material Type 96.

Card 1	1	2	3	4	5	6	7	8
Variable	MID	RO	E	PR	TLIMIT	SLIMIT	FTOUGH	SRETEN
Type	A8	F	F	F	F	F	F	F

Card 2	1	2	3	4	5	6	7	8
Variable	VISC	FRA_RF	E_RF	YS_RF	EH_RF	FS_RF	SIGY	
Type	F	F	F	F	F	F	F	

VARIABLE**DESCRIPTION**

MID	Material identification. A unique number or label not exceeding 8 characters must be specified.
RO	Mass density.
E	Young's modulus.
PR	Poisson's ratio.
TLIMIT	Tensile limit.
SLIMIT	Shear limit.
FTOUGH	Fracture toughness.
SRETEN	Shear retention.
VISC	Viscosity.
FRA_RF	Fraction of reinforcement in section.
E_RF	Young's modulus of reinforcement.
YS_RF	Yield stress of reinforcement.
EH_RF	Hardening modulus of reinforcement.

VARIABLE	DESCRIPTION
FS_RF	Failure strain (true) of reinforcement.
SIGY	Compressive yield stress. EQ.0: no compressive yield

Remarks:

A full description of the tensile and shear damage parts of this material model is given in Govindjee, Kay and Simo [1994,1995]. It is an anisotropic brittle damage model designed primarily for concrete though it can be applied to a wide variety of brittle materials. It admits progressive degradation of tensile and shear strengths across smeared cracks that are initiated under tensile loadings. Compressive failure is governed by a simplistic J2 flow correction that can be disabled if not desired. Damage is handled by treating the rank 4 elastic stiffness tensor as an evolving internal variable for the material. Softening induced mesh dependencies are handled by a characteristic length method [Oliver 1989].

Description of properties:

1. E is the Young's modulus of the undamaged material also known as the virgin modulus.
2. ν is the Poisson's ratio of the undamaged material also known as the virgin Poisson's ratio.
3. f_n is the initial principal tensile strength (stress) of the material. Once this stress has been reached at a point in the body a smeared crack is initiated there with a normal that is co-linear with the 1st principal direction. Once initiated, the crack is fixed at that location, though it will convect with the motion of the body. As the loading progresses the allowed tensile traction normal to the crack plane is progressively degraded to a small machine dependent constant.

The degradation is implemented by reducing the material's modulus normal to the smeared crack plane according to a maximum dissipation law that incorporates exponential softening. The restriction on the normal tractions is given by

$$\phi_t = (\mathbf{n} \otimes \mathbf{n}) : \boldsymbol{\sigma} - f_n + (1 - \varepsilon)f_n(1 - \exp[-H\alpha]) \leq 0$$

where \mathbf{n} is the smeared crack normal, ε is the small constant, H is the softening modulus, and α is an internal variable. H is set automatically by the program; see g_c below. α measures the crack field intensity and is output in the equivalent plastic strain field, $\bar{\varepsilon}^p$, in a normalized fashion.

The evolution of alpha is governed by a maximum dissipation argument. When the normalized value reaches unity it means that the material's strength has been reduced to 2% of its original value in the normal and parallel directions to the smeared crack. Note that for plotting purposes it is never output greater than 5.

4. f_s is the initial shear traction that may be transmitted across a smeared crack plane. The shear traction is limited to be less than or equal to $f_s(1 - \beta)(1 - \exp[-H\alpha])$, through the use of two orthogonal shear damage surfaces. Note that the shear degradation is coupled to the tensile degradation through the internal variable α which measures the intensity of the crack field. β is the shear retention factor defined below. The shear degradation is taken care of by reducing the material's shear stiffness parallel to the smeared crack plane.
5. g_c is the fracture toughness of the material. It should be entered as fracture energy per unit area crack advance. Once entered the softening modulus is automatically calculated based on element and crack geometries.
6. β is the shear retention factor. As the damage progresses the shear tractions allowed across the smeared crack plane asymptote to the product βf_s .
7. η represents the viscosity of the material. Viscous behavior is implemented as a simple Perzyna regularization method. This allows for the inclusion of first order rate effects. The use of some viscosity is recommended as it serves as a regularizing parameter that increases the stability of calculations.
8. σ_y is a uniaxial compressive yield stress. A check on compressive stresses is made using the J2 yield function $\mathbf{s} : \mathbf{s} - \sqrt{\frac{2}{3}}\sigma_y \leq 0$, where \mathbf{s} is the stress deviator. If violated, a J2 return mapping correction is executed. This check is executed when (1) no damage has taken place at an integration point yet, (2) when damage has taken place at a point but the crack is currently closed, and (3) during active damage after the damage integration (i.e. as an operator split). Note that if the crack is open the plasticity correction is done in the plane-stress subspace of the crack plane.

A variety of experimental data has been replicated using this model from quasi-static to explosive situations. Reasonable properties for a standard grade concrete would be $E = 3.15 \times 10^6$ psi, $f_n = 450$ psi, $f_s = 2100$ psi, $\nu = 0.2$, $g_c = 0.8$ lbs/in, $\beta = 0.03$, $\eta = 0.0$ psi-sec, $\sigma_y = 4200$ psi. For stability, values of η between 104 to 106 psi/sec are recommended. Our limited experience thus far has shown that many problems require nonzero values of η to run to avoid error terminations.

Various other internal variables such as crack orientations and degraded stiffness tensors are internally calculated but currently not available for output.

***MAT_GENERAL_JOINT_DISCRETE_BEAM**

This is Material Type 97. This model is used to define a general joint constraining any combination of degrees of freedom between two nodes. The nodes may belong to rigid or deformable bodies. In most applications the end nodes of the beam are coincident and the local coordinate system (r,s,t axes) is defined by CID (see *SECTION_BEAM).

Card 1	1	2	3	4	5	6	7	8
Variable	MID	RO	TR	TS	TT	RR	RS	RT
Type	A8	F	I	I	I	I	I	
Remarks	1							

Card 2	1	2	3	4	5	6	7	8
Variable	RPST	RPSR						
Type	F	F						
Remarks	2							

VARIABLE**DESCRIPTION**

MID	Material identification. A unique number or label not exceeding 8 characters must be specified.
RO	Mass density, see also volume in *SECTION_BEAM definition.
TR	Translational constraint code along the r-axis (0 ⇒ free, 1 ⇒ constrained)
TS	Translational constraint code along the s-axis (0 ⇒ free, 1 ⇒ constrained)

VARIABLE	DESCRIPTION
TT	Translational constraint code along the t-axis (0 ⇒ free, 1 ⇒ constrained)
RR	Rotational constraint code about the r-axis (0 ⇒ free, 1 ⇒ constrained)
RS	Rotational constraint code about the s-axis (0 ⇒ free, 1 ⇒ constrained)
RT	Rotational constraint code about the t-axis (0 ⇒ free, 1 ⇒ constrained)
RPST	Penalty stiffness scale factor for translational constraints.
RPSR	Penalty stiffness scale factor for rotational constraints.

Remarks:

1. For explicit calculations, the additional stiffness due to this joint may require additional mass and inertia for stability. Mass and rotary inertia for this beam element is based on the defined mass density, the volume, and the mass moment of inertia defined in the *SECTION_BEAM input.
2. The penalty stiffness applies to explicit calculations. For implicit calculations, constraint equations are generated and imposed on the system equations; therefore, these constants, RPST and RPSR, are not used.

***MAT_SIMPLIFIED_JOHNSON_COOK_{OPTION}**

Available options include:

<BLANK>

STOCHASTIC

This is Material Type 98. The Johnson/Cook strain sensitive plasticity is used for problems where the strain rates vary over a large range. In this simplified model, thermal effects and damage are ignored, and the maximum stress is directly limited since thermal softening which is very significant in reducing the yield stress under adiabatic loading is not available. An iterative plane stress update is used for the shell elements, but due to the simplifications related to thermal softening and damage, this model is 50% faster than the full Johnson/Cook implementation. To compensate for the lack of thermal softening, limiting stress values are used to keep the stresses within reasonable limits. A resultant formulation for the Belytschko-Tsay, the C0 Triangle, and the fully integrated type 16 shell elements is activated by specifying either zero or one through thickness integration point on the *SECTION_SHELL card. This latter option is less accurate than through thickness integration but is somewhat faster. Since the stresses are not computed in the resultant formulation, the stress output to the databases for the resultant elements are zero. This model is also available for the Hughes-Liu beam, the Belytschko-Schwer beam, and the truss element. For the resultant beam formulation, the rate effects are approximated by the axial rate since the thickness of the beam about it bending axes is unknown. The linear bulk modulus is used to determine the pressure in the elements, since the use of this model is primarily for structural analysis.

Card 1	1	2	3	4	5	6	7	8
Variable	MID	R0	E	PR	VP			
Type	A8	F	F	F	F			
Default	none	none	none	none	0.0			

Card 2	1	2	3	4	5	6	7	8
Variable	A	B	N	C	PSFAIL	SIGMAX	SIGSAT	EPS0
Type	F	F	F	F	F	F	F	F
Default	none	0.0	0.0	0.0	1.0E+17	SIGSAT	1.0E+28	1.0

VARIABLE**DESCRIPTION**

MID	Material identification. A unique number or label not exceeding 8 characters must be specified.
RO	Mass density
E	Young's modulus
PR	Poisson's ratio
VP	Formulation for rate effects: EQ.0.0: Scale yield stress (default), EQ.1.0: Viscoplastic formulation. This option applies only to the 4-node shell and 8-node thick shell if and only if through thickness integration is used.
A	See equations below.
B	See equations below.
N	See equations below.
C	See equations below.
PSFAIL	Effective plastic strain at failure. If zero failure is not considered.
SIGMAX	Maximum stress obtainable from work hardening before rate effects are added (optional). This option is ignored if VP = 1.0
SIGSAT	Saturation stress which limits the maximum value of effective stress which can develop after rate effects are added (optional).
EPS0	Quasi-static threshold strain rate. See description under *MAT_015.

Remarks:

Johnson and Cook express the flow stress as

$$\sigma_y = \left(A + B \bar{\epsilon}^{p^n} \right) (1 + C \ln \dot{\epsilon}^*)$$

where

A, B, C = input constants

$\bar{\epsilon}^p$ = effective plastic strain

$$\dot{\epsilon}^* = \frac{\dot{\bar{\epsilon}}}{EPS0}$$

= normalized effective strain rate

The maximum stress is limited by SIGMAX and SIGSAT by:

$$\sigma_y = \min \left\{ \min \left[A + B \bar{\epsilon}^{p^n}, \text{SIGMAX} \right] (1 + c \ln \dot{\epsilon}^*), \text{SIGSAT} \right\}$$

Failure occurs when the effective plastic strain exceeds PSFAIL.

If the viscoplastic option is active, $VP = 1.0$, the parameters SIGMAX and SIGSAT are ignored since these parameters make convergence of the viscoplastic strain iteration loop difficult to achieve. The viscoplastic option replaces the plastic strain in the forgoing equations by the viscoplastic strain and the strain rate by the viscoplastic strain rate. Numerical noise is substantially reduced by the viscoplastic formulation.

The STOCHASTIC option allows spatially varying yield and failure behavior. See *DEFINE_STOCHASTIC_VARIATION for additional information.

***MAT_099 *MAT_SIMPLIFIED_JOHNSON_COOK_ORTHOTROPIC_DAMAGE**

***MAT_SIMPLIFIED_JOHNSON_COOK_ORTHOTROPIC_DAMAGE**

This is Material Type 99. This model, which is implemented with multiple through thickness integration points, is an extension of model 98 to include orthotropic damage as a means of treating failure in aluminum panels. Directional damage begins after a defined failure strain is reached in tension and continues to evolve until a tensile rupture strain is reached in either one of the two orthogonal directions. After rupture is detected at NUMINT integration points, the element is deleted.

Card 1	1	2	3	4	5	6	7	8
Variable	MID	RO	E	PR	VP	EPPFR	LCDM	NUMINT
Type	A8	F	F	F	F	F	I	I
Default	none	none	none	none	0.0	1.e+16	optional	all points

Card 2	1	2	3	4	5	6	7	8
Variable	A	B	N	C	PSFAIL	SIGMAX	SIGSAT	EPSO
Type	F	F	F	F	F	F	F	F
Default	none	0.0	0.0	0.0	1.0E+17	SIGSAT	1.0E+28	1.0

VARIABLE

DESCRIPTION

MID	Material identification. A unique number or label not exceeding 8 characters must be specified.
RO	Mass density
E	Young's modulus
PR	Poisson's ratio

VARIABLE	DESCRIPTION
VP	Formulation for rate effects: EQ.0.0: Scale yield stress (default), EQ.1.0: Viscoplastic formulation. This option applies only to the 4-node shell and 8-node thick shell if and only if through thickness integration is used.
EPPFR	Plastic strain at which material ruptures (logarithmic).
LCDM	Load curve ID defining nonlinear damage curve. See Figure 2-52 .
NUMINT	Number of through thickness integration points which must fail before the element is deleted. (If zero, all points must fail.) The default of all integration points is not recommended since elements undergoing large strain are often not deleted due to nodal fiber rotations which limit strains at active integration points after most points have failed. Better results are obtained if NUMINT is set to 1 or a number less than one half of the number of through thickness points. For example, if four through thickness points are used, NUMINT should not exceed 2, even for fully integrated shells which have 16 integration points.
A	See equations below.
B	See equations below.
N	See equations below.
C	See equations below.
PSFAIL	Principal plastic strain at failure. If zero failure is not considered.
SIGMAX	Maximum stress obtainable from work hardening before rate effects are added (optional). This option is ignored if VP = 1.0
SIGSAT	Saturation stress which limits the maximum value of effective stress which can develop after rate effects are added (optional).
EPS0	Quasi-static threshold strain rate. See description under *MAT_015.

Remarks:

See the description for the SIMPLIFIED_JOHNSON_COOK model above.

***MAT_SPOTWELD_{OPTION}**

This is Material Type 100. The material model applies to beam element type 9 and to solid element type 1. The failure models apply to both beam and solid elements.

In the case of solid elements, if hourglass type 4 is specified then hourglass type 4 will be used, otherwise, hourglass type 6 will be automatically assigned. Hourglass type 6 is preferred.

The beam elements, based on the Hughes-Liu beam formulation, may be placed between any two deformable shell surfaces and tied with constraint contact, ***CONTACT_SPOTWELD**, which eliminates the need to have adjacent nodes at spot weld locations. Beam spot welds may be placed between rigid bodies and rigid/deformable bodies by making the node on one end of the spot weld a rigid body node which can be an extra node for the rigid body, see ***CONSTRAINED_EXTRA_NODES_OPTION**. In the same way rigid bodies may also be tied together with this spot weld option. This weld option should not be used with rigid body switching. The foregoing advice is valid if solid element spot welds are used; however, since the solid elements have just three degrees-of-freedom at each node, ***CONTACT_TIED_SURFACE_TO_SURFACE** must be used instead of ***CONTACT_SPOTWELD**.

In flat topologies the shell elements have an unconstrained drilling degree-of-freedom which prevents torsional forces from being transmitted. If the torsional forces are deemed to be important, brick elements should be used to model the spot welds.

Beam and solid element force resultants for **MAT_SPOTWELD** are written to the spot weld force file, **SWFORC**, and the file for element stresses and resultants for designated elements, **ELOUT**.

It is advisable to include all spot welds, which provide the slave nodes, and spot welded materials, which define the master segments, within a single *CONTACT_SPOTWELD interface for beam element spot welds or a *CONTACT_TIED_SURFACE_TO_SURFACE interface for solid element spot welds. As a constraint method these interfaces are treated independently which can lead to significant problems if such interfaces share common nodal points. An added benefit is that memory usage can be substantially less with a single interface.

Available options include:

<BLANK>

DAMAGE-FAILURE

The **DAMAGE-FAILURE** option causes one additional line to be read with the damage parameter and a flag that determines how failure is computed from the resultants. On this line the parameter, **RS**, if nonzero, invokes damage mechanics combined with the plasticity model to achieve a smooth drop off of the resultant forces prior to the removal of the spot

weld. The parameter OPT determines the method used in computing resultant based failure, which is unrelated to damage.

Card 1	1	2	3	4	5	6	7	8
Variable	MID	R0	E	PR	SIGY	ET	DT	TFAIL
Type	A8	F	F	F	F	F	F	F

Card 2 for no failure. Additional card for <BLANK> keyword option.

Card 2	1	2	3	4	5	6	7	8
Variable	EFAIL	NRR	NRS	NRT	MRR	MSS	MTT	NF
Type	F	F	F	F	F	F	F	F

Card 2 for resultant based failure. Additional card for DAMAGE-FAILURE keyword option with OPT = -1.0 or 0.0.

Card 2	1	2	3	4	5	6	7	8
Variable	EFAIL	NRR	NRS	NRT	MRR	MSS	MTT	NF
Type	F	F	F	F	F	F	F	F

Card 2 for stress based failure. Additional card for DAMAGE-FAILURE keyword option with OPT = 1.0 and positive values in fields 2 and 3.

Card 2	1	2	3	4	5	6	7	8
Variable	EFAIL	SIGAX	SIGTAU					NF
Type	F	F	F					F

Card 2 for stress based failure. Additional card for DAMAGE-FAILURE keyword option with OPT = 1.0 and negative values in fields 2 and 3.

Card 2	1	2	3	4	5	6	7	8
Variable	EFAIL	-LCAX	-LCTAU					NF
Type	F	F	F					F

Card 2 for used subroutine based failure. Additional card for DAMAGE-FAILURE keyword option with OPT = 2.0, 12, or 22.

Card 2	1	2	3	4	5	6	7	8
Variable	EFAIL	USRV1	USRV2	USRV3	USRV4	USRV5	USRV6	NF
Type	F	F	F	F	F	F	F	F

Card 2 for OPT = 3.0 or 4.0.

Card 2	1	2	3	4	5	6	7	8
Variable	EFAIL	ZD	ZT	ZALP1	ZALP2	ZALP3	ZRRAD	NF
Type	F	F	F	F	F	F	F	F

Card 2 for OPT = 5.0.

Card 2	1	2	3	4	5	6	7	8
Variable	EFAIL	ZD	ZT	ZT2				
Type	F	F	F	F				

Card 2 for OPT = 6.0, 7.0, 9.0, or 10.0.

Card 2	1	2	3	4	5	6	7	8
Variable	EFAIL							NF
Type	F							F

Card 2 for OPT = 11.0.

Card 2	1	2	3	4	5	6	7	8
Variable	EFAIL	LCT	LCC					NF
Type	F	F	F					F

Additional card for the DAMAGE-FAILURE option.

Card 3	1	2	3	4	5	6	7	8
Variable	RS	OPT	FVAL	TRUE_T	ASFF	BETA		DMGOPT
Type	F	F	F	F	I	F		F

Additional card for OPT = 12 or 22.

Card 4	1	2	3	4	5	6	7	8
Variable	USRV7	USRV8	USRV9	USRV10	USRV11	USRV12	USRV13	USRV14
Type	F	F	F	F	F	F	F	F

Additional card for OPT = 12 or 22

Card 5	1	2	3	4	5	6	7	8
Variable	USRV15	USRV16	USRV17	USRV18	USRV19	USRV20	USRV21	USRV22
Type	F	F	F	F	F	F	F	F

VARIABLE	DESCRIPTION
MID	Material identification. A unique number or label not exceeding 8 characters must be specified.
RO	Mass density
E	Young's modulus
PR	Poisson's ratio
SIGY	GT.0: Initial yield stress. LT.0: A yield curve or table is assigned by SIGY . This option is available for beams and starting with release 971 R5.
ET	Hardening modulus, E_t
DT	Time step size for mass scaling, Δt
TFAIL	Failure time if nonzero. If zero this option is ignored.
EFAIL	Effective plastic strain in weld material at failure. If the damage option is inactive, the spot weld element is deleted when the plastic strain at each integration point exceeds EFAIL. If the damage option is active, the plastic strain must exceed the rupture strain (RS) at each integration point before deletion occurs.
NRR	Axial force resultant N_{rr_F} or maximum axial stress σ_{rr}^F at failure depending on the value of OPT (see below). If zero, failure due to this component is not considered. If negative, NRR is the load curve ID defining the maximum axial stress at failure as a function of the effective strain rate.
NRS	Force resultant N_{rs_F} or maximum shear stress τ^F at failure depending on the value of OPT (see below). If zero, failure due to this component is not considered. If negative, NRS is the load curve ID defining the maximum shear stress at failure as a function of the effective strain rate.
NRT	Force resultant N_{rt_F} at failure. If zero, failure due to this component is not considered.
MRR	Torsional moment resultant M_{rr_F} at failure. If zero, failure due to this component is not considered.
MSS	Moment resultant M_{ss_F} at failure. If zero, failure due to this compo-

VARIABLE	DESCRIPTION
	ment is not considered.
MTT	Moment resultant M_{tt_F} at failure. If zero, failure due to this component is not considered.
NF	Number of force vectors stored for filtering (beam elements only).
SIGAX	Maximum axial stress σ_{rr}^F at failure. If zero, failure due to this component is not considered.
SIGTAU	Maximum shear stress τ^F at failure. If zero, failure due to this component is not considered.
LCAX	Load curve ID defining the maximum axial stress at failure as a function of the effective strain rate. Input as a negative number.
LCTAU	Load curve ID defining the maximum shear stress at failure as a function of the effective strain rate. Input as a negative number.
USRVn	Failure constants for user failure subroutine, $n = 1, 2, \dots, 6$.
ZD	Notch diameter
ZT	Sheet thickness.
ZALP1	Correction factor alpha1
ZALP2	Correction factor alpha2
ZALP3	Correction factor alpha3
ZRRAD	Notch root radius (OPT = 3.0 only).
ZT2	Second sheet thickness (OPT = 5.0 only)
LCT	Load curve or Table ID. Load curve defines resultant failure force under tension as a function of loading direction (in degree range 0 to 90). Table defines these curves as functions of strain rates. See remarks. (OPT = 11.0 only)
LCC	Load curve or Table ID. Load curve defines resultant failure force under compression as a function of loading direction (in degree range 0 to 90). Table defines these curves as functions of strain rates. See remarks. (OPT = 11.0 only)
RS	Rupture strain. Define if and only if damage is active.

VARIABLE	DESCRIPTION
OPT	<p>Failure option:</p> <p>EQ.-9: OPT = 9 failure is evaluated and written to the SWFORC file, but element failure is suppressed.</p> <p>EQ.-2: same as option -1 but in addition, the peak value of the failure criteria and the time it occurs is stored and is written into the SWFORC database. This information may be necessary since the instantaneous values written at specified time intervals may miss the peaks. Additional storage is allocated to store this information.</p> <p>EQ.-1: OPT = 0 failure is evaluated and written into the SWFORC file, but element failure is suppressed</p> <p>EQ.0: resultant based failure</p> <p>EQ.1: stress based failure computed from resultants (Toyota)</p> <p>EQ.2: user subroutine uweldfail to determine failure</p> <p>EQ.3: notch stress based failure. (beam and hex assembly welds only).</p> <p>EQ.4: stress intensity factor at failure. (beam and hex assembly welds only).</p> <p>EQ.5: structural stress at failure (beam and hex assembly welds only).</p> <p>EQ.6: stress based failure computed from resultants (Toyota). In this option a shell strain rate dependent failure model is used (beam and hex assembly welds only). The static failure stresses are defined by part ID using the keyword *DEFINE_SPOTWELD_RUPTURE_STRESS.</p> <p>EQ.7: stress based failure for solid elements (Toyota) with peak stresses computed from resultants, and strength values input for pairs of parts, see *DEFINE_SPOTWELD_FAILURE_RESULTANTS. Strain rate effects are optional.</p> <p>EQ.8: not used.</p> <p>EQ.9: stress based failure from resultants (Toyota). In this option a shell strain rate dependent failure model is used (beam welds only). The static failure stresses are defined by part ID using the keyword *DEFINE_SPOTWELD_RUPTURE_PARAMETER.</p> <p>EQ.10: stress based failure with rate effects. Failure data is defined by material using the keyword *DEFINESPOWELD-</p>

VARIABLE	DESCRIPTION
	FAILURE
	EQ.11: resultant based failure (beams only). In this option load curves or tables LCT (tension) and LCC (compression) can be defined as resultant failure force vs. loading direction (curve) or resultant failure force vs. loading direction vs. strain rate (table).
	EQ.12: user subroutine uweldfail12 with 22 material constants to determine damage and failure.
	EQ.22: user subroutine uweldfail22 with 22 material constants to determine failure.
FVAL	Failure parameter. If OPT: EQ.-2: Not used. EQ.-1: Not used. EQ.0: Not used. EQ.1: Not used. EQ.2: Not used. EQ.3: Notch stress value at failure (σ_{KF}). EQ.4: Stress intensity factor value at failure (K_{eqF}). EQ.5: Structural stress value at failure (σ_sF). EQ.6: Number of cycles that failure condition must be met to trigger beam deletion. EQ.7: Not used. EQ.9: Number of cycles that failure condition must be met to trigger beam deletion. EQ.10: ID of data defined by *DEFINE_SPOTWELD_FAILURE.
TRUE_T	True weld thickness. This optional value is available for solid element failure by OPT = 0,1,7, -1 or -2. TRUE_T is used to reduce the moment contribution to the failure calculation from artificially thick weld elements so shear failure can be modeled more accurately. See comments under the remarks for *MAT_SPOTWELD_DAIMLER CHRYSLER
ASFF	Weld assembly simultaneous failure flag EQ.0: Damaged elements fail individually.

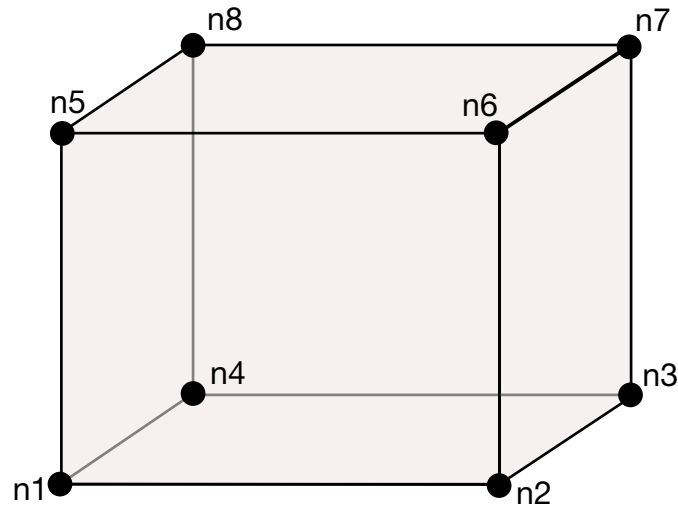

Figure 2-59. A solid element used as spot weld is shown. When resultant based failure is used orientation is very important. Nodes n1-n4 attach to the lower shell mid-surface and nodes n5-n8 attach to the upper shell mid-surface. The resultant forces and moments are computed based on the assumption that the brick element is properly oriented.

VARIABLE	DESCRIPTION
	EQ.1: Damaged elements fail when first reaches failure criterion.
BETA	Damage model decay rate.
DMGOPT	Damage option flag. If DMGOPT: EQ.0: Plastic strain based damage. EQ.1: Plastic strain based damage with post damage stress limit EQ.2: Time based damage with post damage stress limit EQ.10: Like DMGOPT = 0, but failure option will initiate damage EQ.11: Like DMGOPT = 1, but failure option will initiate damage EQ.12: Like DMGOPT = 2, but failure option will initiate damage
USRVn	Failure constants for OPT = 12 or 22 user defined failure, n = 7, 8, ..., 22.

Weld Failure

Spot weld material is modeled with isotropic hardening plasticity coupled to failure models. . EFAIL specifies a failure strain which fails each integration point in the spot weld independently. The OPT parameter is used to specify a failure criterion that fails the entire weld element when the criterion is met. Alternatively, EFAIL and OPT option may be used

to initiate damage when the DAMAGE-FAILURE option is active using RS, BETA, and DMGOPT as described below.

Beam spot weld elements can use any OPT value except 7. Brick spot weld elements can use any OPT value except 3, 4, 5, 6, 9, and -9. Hex assembly spot welds can use any OPT value except 9 and -9.

OPT = -1 or 0

OPT = 0 and OPT = -1 invoke a resultant-based failure criterion that fails the weld if the resultants are outside of the failure surface defined by:

$$\left[\frac{\max(N_{rr}, 0)}{N_{rrF}} \right]^2 + \left[\frac{N_{rs}}{N_{rsF}} \right]^2 + \left[\frac{N_{rt}}{N_{rtF}} \right]^2 + \left[\frac{M_{rr}}{M_{rrF}} \right]^2 + \left[\frac{M_{ss}}{M_{ssF}} \right]^2 + \left[\frac{M_{tt}}{M_{ttF}} \right]^2 - 1 = 0$$

where the *numerators* in the equation are the resultants calculated in the local coordinates of the cross section, and the **denominators** are the values specified in the input. If OPT = -1, the failure surface equation is evaluated, but element failure is suppressed. This allows easy identification of vulnerable spot welds when post-processing. Failure is likely to occur if $FC > 1.0$

OPT = 1:

OPT = 1 invokes a stress based failure model, which was developed by *Toyota Motor Corporation* and is based on the peak axial and transverse shear stresses. The weld fails if the stresses are outside of the failure surface defined by

$$\left(\frac{\sigma_{rr}}{\sigma_{rr}^F} \right)^2 + \left(\frac{\tau}{\tau^F} \right)^2 - 1 = 0$$

If strain rates are considered then the failure criteria becomes:

$$\left[\frac{\sigma_{rr}}{\sigma_{rr}^F(\dot{\epsilon}_{\text{eff}})} \right]^2 + \left[\frac{\tau}{\tau^F(\dot{\epsilon}_{\text{eff}})} \right]^2 - 1 = 0$$

where $\sigma_{rr}^F(\dot{\epsilon}_{\text{eff}})$ and $\tau^F(\dot{\epsilon}_{\text{eff}})$ are defined by load curves LCAX and LCTAU. The peak stresses are calculated from the resultants using simple beam theory.

$$\sigma_{rr} = \frac{N_{rr}}{A} + \frac{\sqrt{M_{ss}^2 + M_{tt}^2}}{Z}$$

$$\tau = \frac{M_{rr}}{2Z} + \frac{\sqrt{N_{rs}^2 + N_{rt}^2}}{A}$$

where the area and section modulus are given by:

$$A = \pi \frac{d^2}{4}$$

$$Z = \pi \frac{d^3}{32}$$

and d is the equivalent diameter of the beam element or solid element used as a spot weld.

OPT = 2

OPT = 2 invokes a user-written subroutine *uweldfail*, documented in Appendix Q.

OPT = 12 or 22

OPT = 12 and OPT = 22 invoke similar user-written subroutines, *uweldfail12*, or, *uweldfail22* respectively. Both allow up to 22 failure parameters to be used rather than the 6 allowed with OPT = 2. OPT = 12 also allows user control of weld damage.

OPT = 3

OPT = 3 invokes a failure based on notch stress, see Zhang [1999]. Failure occurs when the failure criterion:

$$\sigma_k - \sigma_{kF} \geq 0$$

is satisfied. The notch stress is given by the equation:

$$\sigma_k = \alpha_1 \frac{4F}{\pi dt} \left(1 + \frac{\sqrt{3} + \sqrt{19}}{8\sqrt{\pi}} \sqrt{\frac{t}{\rho}} \right) + \alpha_2 \frac{6M}{\pi dt^2} \left(1 + \frac{2}{\sqrt{3\pi}} \sqrt{\frac{t}{\rho}} \right) + \alpha_3 \frac{4F_{rr}}{\pi d^2} \left(1 + \frac{5}{3\sqrt{2\pi}} \frac{d}{t} \sqrt{\frac{t}{\rho}} \right)$$

Here,

$$F = \sqrt{F_{rs}^2 + F_{rt}^2}$$

$$M = \sqrt{M_{ss}^2 + M_{tt}^2}$$

and α_i $i = 1,2,3$ are input corrections factors with default values of unity. If spot welds are between sheets of unequal thickness, the minimum thickness of the spot welded sheets may be introduced as a crude approximation.

OPT = 4

OPT = 4 invokes failure based on structural stress intensity, see Zhang [1999]. Failure occurs when the failure criterion:

$$K_{eq} - K_{eqF} \geq 0$$

is satisfied where

$$K_{eq} = \sqrt{K_I^2 + K_{II}^2}$$

and

$$K_I = \alpha_1 \frac{\sqrt{3}F}{2\pi d\sqrt{t}} + \alpha_2 \frac{2\sqrt{3}M}{\pi dt\sqrt{t}} + \alpha_3 \frac{5\sqrt{2}F_{rr}}{3\pi d\sqrt{t}}$$

$$K_{II} = \alpha_1 \frac{2F}{\pi d\sqrt{t}}$$

Here, F and M are as defined above for the notch stress formulas and again, α_i $i = 1,2,3$ are input corrections factors with default values of unity. If spot welds are between sheets of unequal thickness, the minimum thickness of the spot welded sheets may be used as a crude approximation.

The maximum structural stress at the spot weld was utilized successfully for predicting the fatigue failure of spot welds, see Rupp, et. al. [1994] and Sheppard [1993]. The corresponding results according to Rupp, et. al. are listed below where it is assumed that they may be suitable for crash conditions.

OPT = 5

OPT = 5 invokes failure by

$$\max(\sigma_{v1}, \sigma_{v2}, \sigma_{v3}) - \sigma_{sF} = 0$$

where σ_{sF} is the critical value of structural stress at failure. It is noted that the forces and moments in the equations below are referred to the beam nodes 1, 2, and to the midpoint, respectively. The three stress values, $\sigma_{v1}, \sigma_{v2}, \sigma_{v3}$, are defined by:

$$\sigma_{v1}(\zeta) = \frac{F_{rs1}}{\pi dt_1} \cos\zeta + \frac{F_{rt1}}{\pi dt_1} \sin\zeta - \frac{1.046\beta_1 F_{rr1}}{t_1\sqrt{t_1}} - \frac{1.123M_{ss1}}{dt_1\sqrt{t_1}} \sin\zeta + \frac{1.123M_{tt1}}{dt_1\sqrt{t_1}} \cos\zeta$$

with

$$\beta_1 = \begin{cases} 0 & F_{rr1} \leq 0 \\ 1 & F_{rr1} > 0 \end{cases}$$

$$\sigma_{v2}(\zeta) = \frac{F_{rs2}}{\pi dt_2} \cos\zeta + \frac{F_{rt2}}{\pi dt_2} \sin\zeta - \frac{1.046\beta_1 F_{rr2}}{t_2\sqrt{t_2}} + \frac{1.123M_{ss2}}{dt_2\sqrt{t_2}} \sin\zeta - \frac{1.123M_{tt2}}{dt_2\sqrt{t_2}} \cos\zeta$$

with

$$\beta_2 = \begin{cases} 0 & F_{rr2} \leq 0 \\ 1 & F_{rr2} > 0 \end{cases}$$

$$\sigma_{v3}(\zeta) = 0.5\sigma(\zeta) + 0.5\sigma(\zeta)\cos(2\alpha) + 0.5\tau(\zeta)\sin(2\alpha)$$

where

$$\sigma(\zeta) = \frac{4\beta_3 F_{rr}}{\pi d^2} + \frac{32M_{ss}}{\pi d^3} \sin\zeta - \frac{32M_{tt}}{\pi d^3} \cos\zeta$$

$$\tau(\zeta) = \frac{16F_{rs}}{3\pi d^2} \sin^2 \zeta + \frac{16F_{rt}}{3\pi d^2} \cos^2 \zeta$$

$$\alpha = \frac{1}{2} \tan^{-1} \frac{2\tau(\zeta)}{\sigma(\zeta)}$$

$$\beta_3 = \begin{cases} 0 & F_{rr} \leq 0 \\ 1 & F_{rr} > 0 \end{cases}$$

The stresses are calculated for all directions, $0^\circ \leq \zeta \leq 90^\circ$, in order to find the maximum.

OPT = 10

OPT = 10 invokes the failure criterion developed by Lee and Balur (2011). It is available for welds modeled by beam elements, solid elements, or solid assemblies. A detailed discussion of the criterion is given in the user's manual section for *DEFINE_SPOTWELD_FAILURE.

OPT = 11

OPT = 11 invokes a resultant force based failure criterion for beams. With corresponding load curves or tables LCT and LCC, resultant force at failure F_{fail} can be defined as function of loading direction γ (curve) or loading direction γ and effective strain rate $\dot{\epsilon}$ (table):

$$F_{fail} = f(\gamma) \quad \text{or} \quad F_{fail} = f(\gamma, \dot{\epsilon})$$

with the following definitions for loading direction (in degree) and effective strain rate:

$$\gamma = \tan^{-1} \left(\left| \frac{F_{shear}}{F_{axial}} \right| \right), \quad \dot{\epsilon} = \left[\frac{2}{3} (\dot{\epsilon}_{axial}^2 + \dot{\epsilon}_{shear}^2) \right]^{1/2}$$

It depends on the sign of the axial beam force, if LCT or LCC are used for failure condition:

$$F_{axial} > 0: \quad [F_{axial}^2 + F_{shear}^2]^{1/2} > F_{fail,LCT} \rightarrow \text{failure}$$

$$F_{axial} < 0: \quad [F_{axial}^2 + F_{shear}^2]^{1/2} > F_{fail,LCC} \rightarrow \text{failure}$$

For all OPT failure criteria, if a zero is input for a failure parameter on card 2, the corresponding term will be omitted from the equation. For example, if for OPT = 0, only N_{rrF} is nonzero, the failure surface is reduced to $|N_{rr}| = N_{rrF}$.

Similarly, if the failure strain EFAIL is set to zero, the failure strain model is not used. Both EFAIL and OPT failure may be active at the same time.

NF specifies the number of terms used to filter the stresses or resultants used in the OPT failure criterion. NF cannot exceed 30. The default value is set to zero which is generally recommended unless oscillatory resultant forces are observed in the time history databases. Although welds should not oscillate significantly, this option was added for consistency

with the other spot weld options. NF affects the storage since it is necessary to store the resultant forces as history variables. The NF parameter is available only for beam element welds.

The inertias of the spot welds are scaled during the first time step so that their stable time step size is Δt . A strong compressive load on the spot weld at a later time may reduce the length of the spot weld so that stable time step size drops below Δt . If the value of Δt is zero, mass scaling is not performed, and the spot welds will probably limit the time step size. Under most circumstances, the inertias of the spot welds are small enough that scaling them will have a negligible effect on the structural response and the use of this option is encouraged.

Spot weld force history data is written into the SWFORC ascii file. In this database the resultant moments are not available, but they are in the binary time history database and in the ASCII elout file.

Damage

When the DAMAGE-FAILURE option is invoked, the constitutive properties for the damaged material are obtained from the undamaged material properties. The amount of damage evolved is represented by the constant, ω , which varies from zero if no damage has occurred to unity for complete rupture. For uniaxial loading, the nominal stress in the damaged material is given by

$$\sigma_{\text{nominal}} = \frac{P}{A}$$

where P is the applied load and A is the surface area. The true stress is given by:

$$\sigma_{\text{true}} = \frac{P}{A - A_{\text{loss}}}$$

where A_{loss} is the void area. The damage variable can then be defined:

$$\omega = \frac{A_{\text{loss}}}{A}$$

where,

$$0 \leq \omega \leq 1$$

In this model, damage is initiated when the effective plastic strain in the weld exceeds the failure strain, EFAIL. If DMGOPT = 10, 11, or 12, damage will initiate when the effective plastic strain exceeds EFAIL, or when the failure criterion is met, whichever occurs first. The failure criterion is specified by OPT parameter. After damage initiates, the damage variable is evaluated by one of two ways.

For DMGOPT = 0, 1, 10, or 11, the damage variable is a function of effective plastic strain in the weld:

$$\varepsilon_{\text{failure}}^p \leq \varepsilon_{\text{eff}}^p \leq \varepsilon_{\text{rupture}}^p \Rightarrow \omega = \frac{\varepsilon_{\text{eff}}^p - \varepsilon_{\text{failure}}^p}{\varepsilon_{\text{rupture}}^p - \varepsilon_{\text{failure}}^p}$$

where $\varepsilon_{\text{failure}}^p = \text{EFAIL}$ and $\varepsilon_{\text{rupture}}^p = \text{RS}$. For $\text{DMGOPT} = 2$ or 12 , the damage variable is a function of time:

$$t_{\text{failure}} \leq t \leq t_{\text{rupture}} \Rightarrow \omega = \frac{t - t_{\text{failure}}}{t_{\text{rupture}}}$$

where t_{failure} is the time at which damage initiates, and $t_{\text{rupture}} = \text{RS}$. For this criteria, t_{failure} is set to either the time when $\varepsilon_{\text{eff}}^p$ exceeds EFAIL , or the time when the failure criterion is met.

For $\text{DMGOPT} = 1$, the damage behavior is the same as for $\text{DMGOPT} = 0$, but an additional damage variable is calculated to prevent stress growth during softening. Similarly, $\text{DMGOPT} = 11$ behaves like $\text{DMGOPT} = 10$ except for the additional damage variable. This additional function is also used with $\text{DMGOPT} = 2$ and 12 . The affect of this additional damage function is noticed only in brick and brick assembly welds in tension loading where it prevents growth of the tensile force in the weld after damage initiates.

BETA

If **BETA** is specified, the stress is multiplied by an exponential using ω defined in the previous equations,

$$\sigma_d = \sigma \exp(-\beta\omega).$$

For weld elements in an assembly (see **RPBHX** on ***CONTROL_SPOTWELD_BEAM** or ***DEFINE_HEX_SPOTWELD_ASSEMBLY**), the failure criterion is evaluated using the assembly cross section. If damage is not active, all elements will be deleted when the failure criterion is met. If damage is active, then damage is calculated independently in each element of the assembly. By default, elements of the assembly are deleted as damage in each element is complete. If **ASFF** = 1, then failure and deletion of all elements in the assembly will occur simultaneously when damage is complete in any one of the elements.

TRUE_T

Weld elements and weld assemblies are tied to the mid-plane of shell materials and so typically have a thickness that is half the sum of the thicknesses of the welded shell sections. As a result, a weld under shear loading can be subject to an artificially large moment which will be balanced by normal forces transferred through the tied contact. These normal forces will cause the out-of-plane bending moment used in the failure calculation to be artificially high. Inputting a **TRUE_T** that is smaller than the modeled thickness, for exam-

ple, 10%-30% of true thickness will scale down the moment or stress that results from the balancing moment and provide more realistic failure calculations for solid elements and weld assemblies. TRUE_T effects only the failure calculation, not the weld element behavior. If TRUE_T = 0 or data is omitted, the modeled weld element thickness is used. For OPT = 0, the two out-of-plane moments, M_{ss} and M_{tt} are replaced by modified terms \widehat{M}_{ss} and \widehat{M}_{tt} , as shown below:

$$\left[\frac{\max(N_{rr}, 0)}{N_{rrF}} \right]^2 + \left[\frac{N_{rs}}{N_{rsF}} \right]^2 + \left[\frac{N_{rt}}{N_{rtF}} \right]^2 + \left[\frac{M_{rr}}{M_{rrF}} \right]^2 + \left[\frac{\widehat{M}_{ss}}{M_{ssF}} \right]^2 + \left[\frac{\widehat{M}_{tt}}{M_{ttF}} \right]^2 - 1 = 0$$

$$\widehat{M}_{ss} = M_{ss} - N_{rt}(t - t_{true})$$

$$\widehat{M}_{tt} = M_{tt} - N_{rs}(t - t_{true})$$

In the above, t is the element thickness and t_{true} is the TRUE_T parameter. For OPT = 1, the same modification is done to the moments that contribute to the normal stress, as shown below:

$$\sigma_{rr} = \frac{N_{rr}}{A} + \frac{\sqrt{\widehat{M}_{ss}^2 + \widehat{M}_{tt}^2}}{Z}$$

Uniaxial option

A uniaxial stress option is available for solid and solid weld assemblies. It is invoked by defining the elastic modulus, E as a negative number where the absolute value of E is the desired value for E. The uniaxial option causes the two transverse stress terms to be assumed to be zero throughout the calculation. This assumption eliminates parasitic transverse stress that causes slow growth of plastic strain based damage. The motivation for this option can be explained with a weld loaded in tension. Due to Poisson's effect, an element in tension would be expected to contract in the transverse directions. However, because the weld nodes are constrained to the mid-plane of shell elements, such contraction is only possible to the degree that that shell element contracts. In other words, the uniaxial stress state cannot be represented by the weld. For plastic strain based damage, this effect can be particularly apparent as it causes tensile stress to continue to grow very large as the stress state becomes very nearly triaxial tension. In this stress state, plastic strain grows very slowly so it appears that damage calculation is failing to knock down the stress. By assuming that the transverse stresses are zero, the plastic strain grows as expected and damage is much more effective.

***MAT_SPOTWELD_DAIMLERCHRYSLER**

This is Material Type 100. The material model applies only to solid element type 1. If hourglass type 4 is specified then hourglass type 4 will be used, otherwise, hourglass type 6 will be automatically assigned. Hourglass type 6 is preferred.

Spot weld elements may be placed between any two deformable shell surfaces and tied with constraint contact, *CONTACT_TIED_SURFACE_TO_SURFACE, which eliminates the need to have adjacent nodes at spot weld locations. Spot weld failure is modeled using this card and *DEFINE_CONNECTION_PROPERTIES data. Details of the failure model can be found in Seeger, Feucht, Frank, Haufe, and Keding [2005].

NOTE: It is advisable to include all spot welds, which provide the slave nodes, and spot welded materials, which define the master segments, within a single *CONTACT_TIED_SURFACE_TO_SURFACE interface.

This contact type uses constraint equations. If multiple interfaces are treated independently, significant problems can occur if such interfaces share common nodes. An added benefit is that memory usage can be substantially less with a single interface.

Card 1	1	2	3	4	5	6	7	8
Variable	MID	RO	E	PR			DT	TFAIL
Type	A8	F	F	F			F	F

Card 2	1	2	3	4	5	6	7	8
Variable	EFAIL							NF
Type	F							F

Card 3	1	2	3	4	5	6	7	8
Variable	RS	ASFF		TRUE_T	CON_ID			
Type	F	I		F	F			

VARIABLE	DESCRIPTION
MID	Material identification. A unique number or label not exceeding 8 characters must be specified.
RO	Mass density.
E	Young's modulus.
PR	Poisson's ratio.
DT	Time step size for mass scaling, Δt .
TFAIL	Failure time if nonzero. If zero this option is ignored.
EFAIL	Effective plastic strain in weld material at failure. See remark below.
NF	Number of failure function evaluations stored for filtering by time averaging. The default value is set to zero which is generally recommended unless oscillatory resultant forces are observed in the time history databases. Even though these welds should not oscillate significantly, this option was added for consistency with the other spot weld options. NF affects the storage since it is necessary to store the failure terms. When NF is nonzero, the resultants in the output databases are filtered. NF cannot exceed 30.
RS	Rupture strain. See Remarks below.
ASFF	Weld assembly simultaneous failure flag EQ.0: Damaged elements fail individually. EQ.1: Damaged elements fail when first reaches failure criterion.
TRUE_T	True weld thickness for single hexahedron solid weld elements. See comments below.
CON_ID	Connection ID of *DEFINE_CONNECTION card. A negative CON_ID deactivates failure, see comments below.

Remarks:

This weld material is modeled with isotropic hardening plasticity. The yield stress and constant hardening modulus are assumed to be those of the welded shell elements as defined in a *DEFINE_CONNECTION_PROPERTIES table. A failure function and damage type is also defined by *DEFINE_CONNECTION_PROPERTIES data. The interpretation of

EFAIL and RS is determined by the choice of damage type. This is discussed in remark 4 on *DEFINE_CONNECTION_PROPERTIES.

Solid weld elements are tied to the mid-plane of shell materials and so typically have a thickness that is half the sum of the thicknesses of the welded shell sections. As a result, a weld under shear loading can be subject to an artificially large moment which will be balanced by normal forces transferred through the tied contact. These normal forces will cause the normal term in the failure calculation to be artificially high. Inputting a TRUE_T that is smaller than the modeled thickness, for example, 10%-30% of true thickness will scale down the normal force that results from the balancing moment and provide more realistic failure calculations. TRUE_T effects only the failure calculation, not the weld element behavior. If TRUE_T = 0 or data is omitted, the modeled weld element thickness is used.

For weld elements in an assembly (see RPBHX on *CONTROL_SPOTWELD_BEAM or *DEFINE_HEX_SPOTWELD_ASSEMBLY), the failure criterion is evaluated using the assembly cross section. If damage is not active, all elements will be deleted when the failure criterion is met. If damage is active, then damage is calculated independently in each element of the assembly. By default, elements of the assembly are deleted as damage in each element is complete. If ASFF = 1, then failure and deletion of all elements in the assembly will occur simultaneously when damage is complete in any one of the elements.

Solid element force resultants for MAT_SPOTWELD are written to the spot weld force file, SWFORC, and the file for element stresses and resultants for designated elements, ELOUT. Also, spot weld failure data is written to the file, DCFAIL.

An option to deactivate weld failure is switched on by setting CON_ID to a negative value where the absolute value of CON_ID becomes the connection ID. When weld failure is deactivated, the failure function is evaluated and output to SWFORC and DCFAIL but the weld retains its full strength.

*MAT_GEPLASTIC_SRATE_2000a

This is Material Type 101. The GEPLASTIC_SRATE_2000a material model characterizes General Electric's commercially available engineering thermoplastics subjected to high strain rate events. This material model features the variation of yield stress as a function of strain rate, cavitation effects of rubber modified materials and automatic element deletion of either ductile or brittle materials.

Card 1	1	2	3	4	5	6	7	8
Variable	MID	RO	E	PR	RATESF	EDOT0	ALPHA	
Type	A8	F	F	F	F	F	F	

Card 2	1	2	3	4	5	6	7	8
Variable	LCSS	LCFEPS	LCFSIG	LCE				
Type	F	F	F	F				

VARIABLE	DESCRIPTION
MID	Material identification. A unique number or label not exceeding 8 characters must be specified.
RO	Mass density.
E	Young's Modulus.
PR	Poisson's ratio.
RATESF	Constant in plastic strain rate equation.
EDOT0	Reference strain rate
ALPHA	Pressure sensitivity factor
LCSS	Load curve ID or Table ID that defines the post yield material behavior. The values of this stress-strain curve are the difference of the yield stress and strain respectively. This means the first values for both stress and strain should be zero. All subsequent values will define softening or hardening.

VARIABLE	DESCRIPTION
LCFEPS	Load curve ID that defines the plastic failure strain as a function of strain rate.
LCFSIG	Load curve ID that defines the Maximum principal failure stress as a function of strain rate.
LCE	Load curve ID that defines the Unloading moduli as a function of plastic strain.

Remarks:

The constitutive model for this approach is:

$$\dot{\epsilon}_p = \dot{\epsilon}_0 \exp\{A[\sigma - S(\epsilon_p)]\} \times \exp(-p\alpha A)$$

where $\dot{\epsilon}_0$ and A are rate dependent yield stress parameters, $S(\epsilon_p)$ internal resistance (strain hardening) and α is a pressure dependence parameter.

In this material the yield stress may vary throughout the finite element model as a function of strain rate and hydrostatic stress. Post yield stress behavior is captured in material softening and hardening values. Finally, ductile or brittle failure measured by plastic strain or maximum principal stress respectively is accounted for by automatic element deletion.

Although this may be applied to a variety of engineering thermoplastics, GE Plastics have constants available for use in a wide range of commercially available grades of their engineering thermoplastics.

*MAT_INV_HYPERBOLIC_SIN

This is Material Type 102. It allows the modeling of temperature and rate dependent plasticity, Sheppard and Wright [1979].

Card 1	1	2	3	4	5	6	7	8
Variable	MID	RO	E	PR	T	HC	VP	
Type	A8	F	F	F	F	F	F	

Card 2	1	2	3	4	5	6	7	8
Variable	ALPHA	N	A	Q	G	EPS0	LCQ	
Type	F	F	F	F	F	F	I	

VARIABLE	DESCRIPTION
MID	Material identification. A unique number or label not exceeding 8 characters must be specified.
RO	Mass density.
E	Young’s Modulus.
PR	Poisson’s ratio
T	Initial Temperature.
HC	Heat generation coefficient.
VP	Formulation for rate effects: EQ.0.0: Scale yield stress (default) EQ.1.0: Viscoplastic formulation.
ALPHA	See Remarks.
N	See Remarks.
A	See Remarks.

VARIABLE	DESCRIPTION
Q	See Remarks.
G	See Remarks.
EPS0	Minimum strain rate considered in calculating Z.
LCQ	Load curve for definition of parameter Q. GT.0: Q as function of plastic strain. LT.0: Q as function of temperature.

Remarks:

Resistance to deformation is both temperature and strain rate dependent. The flow stress equation is:

$$\sigma = \frac{1}{\alpha} \sinh^{-1} \left[\left(\frac{Z}{A} \right)^{\frac{1}{N}} \right]$$

where Z, the Zener-Holloman temperature compensated strain rate, is:

$$Z = \max(\dot{\epsilon}, \text{EPS0}) \times \exp \left(\frac{Q}{GT} \right)$$

The units of the material constitutive constants are as follows: A (1/sec), N (dimensionless), α (1/MPa), the activation energy for flow, Q(J/mol), and the universal gas constant, G (J/mol K). The value of G will only vary with the unit system chosen. Typically it will be either 8.3144 J/mol ∞ K, or 40.8825 lb in/mol ∞ R.

The final equation necessary to complete our description of high strain rate deformation is one that allows us to compute the temperature change during the deformation. In the absence of a couples thermo-mechanical finite element code we assume adiabatic temperature change and follow the empirical assumption that 90-95% of the plastic work is dissipated as heat. Thus the heat generation coefficient is

$$\text{HC} \approx \frac{0.9}{\rho C_v}$$

where ρ is the density of the material and C_v is the specific heat.

***MAT_ANISOTROPIC_VISCOPLASTIC**

This is Material Type 103. This anisotropic-viscoplastic material model applies to shell and brick elements. The material constants may be fit directly or, if desired, stress versus strain data may be input and a least squares fit will be performed by LS-DYNA to determine the constants. Kinematic or isotropic or a combination of kinematic and isotropic hardening may be used. A detailed description of this model can be found in the following references: Berstad, Langseth, and Hopperstad [1994]; Hopperstad and Remseth [1995]; and Berstad [1996]. Failure is based on effective plastic strain or by a user defined subroutine.

Card 1	1	2	3	4	5	6	7	8
Variable	MID	R0	E	PR	SIGY	FLAG	LCSS	ALPHA
Type	A8	F	F	F	F	F	F	F

Card 2	1	2	3	4	5	6	7	8
Variable	QR1	CR1	QR2	CR2	QX1	CX1	QX2	CX2
Type	F	F	F	F	F	F	F	F

Card 3	1	2	3	4	5	6	7	8
Variable	VK	VM	R00 or F	R45 or G	R90 or H	L	M	N
Type	F	F	F	F	F	F	F	F

Card 4	1	2	3	4	5	6	7	8
Variable	AOPT	FAIL	NUMINT	MACF				
Type	F	F	F	I				

Card 5	1	2	3	4	5	6	7	8
Variable	XP	YP	ZP	A1	A2	A3		
Type	F	F	F	F	F	F		

Card 6	1	2	3	4	5	6	7	8
Variable	V1	V2	V3	D1	D2	D3	BETA	
Type	F	F	F	F	F	F	F	

VARIABLE**DESCRIPTION**

MID	Material identification. A unique number or label not exceeding 8 characters must be specified.
RO	Mass density.
E	Young's modulus
PR	Poisson's ratio
SIGY	Initial yield stress
FLAG	Flag <ul style="list-style-type: none"> EQ.0: Give all material parameters EQ.1: Material parameters are fit in LS-DYNA to Load curve or Table given below. The parameters Q_{r1}, C_{r1}, Q_{r2}, and C_{r2} for isotropic hardening are determined by the fit and those for kinematic hardening are found by scaling those for isotropic hardening by $.(1 - \alpha)$ where α is defined below in columns 51-60. EQ.2: Use load curve directly, i.e., no fitting is required for the parameters Q_{r1}, C_{r1}, Q_{r2}, and C_{r2}. A table is not allowed.

VARIABLE	DESCRIPTION
LCSS	Load curve ID or Table ID. The load curve ID defines effective stress versus effective plastic strain. Card 2 is ignored with this option. The table ID, see Figure 2-12 , defines for each strain rate value a load curve ID giving the stress versus effective plastic strain for that rate. If the load curve only is used, then the coefficients V_k and V_m must be given if viscoplastic behavior is desired. If a Table ID is given these coefficients are determined internally during initialization.
ALPHA	α distribution of hardening used in the curve-fitting. $\alpha = 0$ pure kinematic hardening and $\alpha = 1$ provides pure isotropic hardening
QR1	Isotropic hardening parameter Q_{r1}
CR1	Isotropic hardening parameter C_{r1}
QR2	Isotropic hardening parameter Q_{r2}
CR2	Isotropic hardening parameter C_{r2}
QX1	Kinematic hardening parameter $Q_{\chi1}$
CX1	Kinematic hardening parameter $C_{\chi1}$
QX2	Kinematic hardening parameter $Q_{\chi2}$
CX2	Kinematic hardening parameter $C_{\chi2}$
VK	Viscous material parameter V_k
VM	Viscous material parameter V_m
R00	R_{00} for shell (Default = 1.0)
R45	R_{45} for shell (Default = 1.0)
R90	R_{90} for shell (Default = 1.0)
F	F for brick (Default = 1/2)
G	G for brick (Default = 1/2)
H	H for brick (Default = 1/2)
L	L for brick (Default = 3/2)

VARIABLE	DESCRIPTION
M	<i>M</i> for brick (Default = 3/2)
N	<i>N</i> for brick (Default = 3/2)
AOPT	<p>Material axes option (see <i>MAT_OPTION TROPIC_ELASTIC</i> for a more complete description):</p> <p>EQ.0.0: locally orthotropic with material axes determined by element nodes 1, 2, and 4, as with <i>*DEFINE_COORDINATE_NODES</i>, and then, for shells only, rotated about the shell element normal by an angle <i>BETA</i>.</p> <p>EQ.1.0: locally orthotropic with material axes determined by a point in space and the global location of the element center; this is the <i>a</i>-direction. This option is for solid elements only.</p> <p>EQ.2.0: globally orthotropic with material axes determined by vectors defined below, as with <i>*DEFINE_COORDINATE_VECTOR</i>.</p> <p>EQ.3.0: locally orthotropic material axes determined by rotating the material axes about the element normal by an angle, <i>BETA</i>, from a line in the plane of the element defined by the cross product of the vector <i>v</i> with the element normal.</p> <p>EQ.4.0: locally orthotropic in cylindrical coordinate system with the material axes determined by a vector <i>v</i>, and an originating point, <i>P</i>, which define the centerline axis. This option is for solid elements only.</p> <p>LT.0.0: the absolute value of <i>AOPT</i> is a coordinate system ID number (<i>CID</i> on <i>*DEFINE_COORDINATE_NODES</i>, <i>*DEFINE_COORDINATE_SYSTEM</i> or <i>*DEFINE_COORDINATE_VECTOR</i>). Available in R3 version of 971 and later.</p>

VARIABLE	DESCRIPTION
FAIL	Failure flag. LT.0.0: User defined failure subroutine is called to determine failure. This is subroutine named, MATUSR_103, in DYN21.F. EQ.0.0: Failure is not considered. This option is recommended if failure is not of interest since many calculations will be saved. GT.0.0: Plastic strain to failure. When the plastic strain reaches this value, the element is deleted from the calculation.
NUMINT	Number of integration points which must fail before element deletion. If zero, all points must fail. This option applies to shell elements only. For the case of one point shells, NUMINT should be set to a value that is less than the number of through thickness integration points. Nonphysical stretching can sometimes appear in the results if all integration points have failed except for one point away from the midsurface. This is due to the fact that unconstrained nodal rotations will prevent strains from developing at the remaining integration point. In fully integrated shells, similar problems can occur.
MACF	Material axes change flag for brick elements: EQ.1: No change, default, EQ.2: switch material axes a and b, EQ.3: switch material axes a and c, EQ.4: switch material axes b and c.
XP, YP, ZP	$x_p y_p z_p$, define coordinates of point p for AOPT = 1 and 4.
A1, A2, A3	$a_1 a_2 a_3$, define components of vector a for AOPT = 2.
V1, V2, V3	$v_1 v_2 v_3$, define components of vector v for AOPT = 3 and 4.
D1, D2, D3	$d_1 d_2 d_3$, define components of vector d for AOPT = 2.
BETA	Material angle in degrees for AOPT = 0 (shells only) and AOPT = 3. BETA may be overridden on the element card, see *ELEMENT_SHELL_BETA and *ELEMENT_SOLID_ORTHO.

Remarks:

The uniaxial stress-strain curve is given on the following form

$$\begin{aligned} \sigma(\varepsilon_{\text{eff}}^p, \dot{\varepsilon}_{\text{eff}}^p) = & \sigma_0 + Q_{r1}[(1 - \exp(-C_{r1}\varepsilon_{\text{eff}}^p))] + Q_{r2}[1 - \exp(-C_{r2}\varepsilon_{\text{eff}}^p)] \\ & + Q_{\chi1}[(1 - \exp(-C_{\chi1}\varepsilon_{\text{eff}}^p))] + Q_{\chi2}[(1 - \exp(-C_{\chi2}\varepsilon_{\text{eff}}^p))] + V_k \dot{\varepsilon}_{\text{eff}}^p V_m \end{aligned}$$

For bricks the following yield criteria is used

$$\begin{aligned} F(\sigma_{22} - \sigma_{33})^2 + G(\sigma_{33} - \sigma_{11})^2 + H(\sigma_{11} - \sigma_{22})^2 + 2L\sigma_{23}^2 + 2M\sigma_{31}^2 + 2N\sigma_{12}^2 \\ = [\sigma(\varepsilon_{\text{eff}}^p, \dot{\varepsilon}_{\text{eff}}^p)]^2 \end{aligned}$$

where $\varepsilon_{\text{eff}}^p$ is the effective plastic strain and $\dot{\varepsilon}_{\text{eff}}^p$ is the effective plastic strain rate. For shells the anisotropic behavior is given by R_{00} , R_{45} and R_{90} . The model will work when the three first parameters in card 3 are given values. When $V_k = 0$ the material will behave elasto-plastically. Default values are given by:

$$F = G = H = \frac{1}{2}$$

$$L = M = N = \frac{3}{2}$$

$$R_{00} = R_{45} = R_{90} = 1$$

Strain rate of accounted for using the Cowper and Symonds model which, e.g., model 3, scales the yield stress with the factor:

$$1 + \left(\frac{\dot{\varepsilon}_{\text{eff}}^p}{C}\right)^{1/p}$$

To convert these constants set the viscoelastic constants, V_k and V_m , to the following values:

$$V_k = \sigma \left(\frac{1}{C}\right)^{\frac{1}{p}}$$

$$V_m = \frac{1}{p}$$

This model properly treats rate effects. The viscoplastic rate formulation is an option in other plasticity models in LS-DYNA, e.g., mat_3 and mat_24, invoked by setting the parameter VP to 1.

***MAT_ANISOTROPIC_PLASTIC**

This is Material Type 103_P. This anisotropic-plastic material model is a simplified version of the MAT_ANISOTROPIC_VISCOPLASTIC above. This material model applies only to shell elements.

Card 1	1	2	3	4	5	6	7	8
Variable	MID	R0	E	PR	SIGY	LCSS		
Type	A8	F	F	F	F	F		

Card 2	1	2	3	4	5	6	7	8
Variable	QR1	CR1	QR2	CR2				
Type	F	F	F	F				

Card 3	1	2	3	4	5	6	7	8
Variable	R00	R45	R90	S11	S22	S33	S12	
Type	F	F	F	F	F	F	F	

Card 4	1	2	3	4	5	6	7	8
Variable	AOPT							
Type	F							

Card 5	1	2	3	4	5	6	7	8
Variable	XP	YP	ZP	A1	A2	A3		
Type	F	F	F	F	F	F		

Card 6	1	2	3	4	5	6	7	8
Variable	V1	V2	V3	D1	D2	D3	BETA	
Type	F	F	F	F	F	F	F	

VARIABLE**DESCRIPTION**

MID	Material identification. A unique number or label not exceeding 8 characters must be specified.
RO	Mass density.
E	Young's modulus
PR	Poisson's ratio
SIGY	Initial yield stress
LCSS	Load curve ID. The load curve ID defines effective stress versus effective plastic strain. Card 2 is ignored with this option.
QR1	Isotropic hardening parameter Q_{r1}
CR1	Isotropic hardening parameter C_{r1}
QR2	Isotropic hardening parameter Q_{r2}
CR2	Isotropic hardening parameter C_{r2}
R00	R_{00} for anisotropic hardening
R45	R_{45} for anisotropic hardening
R90	R_{90} for anisotropic hardening
S11	Yield stress in local x-direction. This input is ignored if $(R_{00}, R_{45}, R_{90}) > 0$.
S22	Yield stress in local y-direction. This input is ignored if $(R_{00}, R_{45}, R_{90}) > 0$.
S33	Yield stress in local z-direction. This input is ignored if $(R_{00}, R_{45}, R_{90}) > 0$.

VARIABLE	DESCRIPTION
S12	Yield stress in local xy-direction. This input is ignored if $(R_{00}, R_{45}, R_{90}) > 0$.
AOPT	Material axes option (see MAT_OPTION TROPIC_ELASTIC for a more complete description): <p>EQ.0.0: locally orthotropic with material axes determined by element nodes 1, 2, and 4, as with *DEFINE_COORDINATE_NODES, and then rotated about the shell element normal by an angle BETA.</p> <p>EQ.2.0: globally orthotropic with material axes determined by vectors defined below, as with *DEFINE_COORDINATE_VECTOR.</p> <p>EQ.3.0: locally orthotropic material axes determined by rotating the material axes about the element normal by an angle, BETA, from a line in the plane of the element defined by the cross product of the vector \mathbf{v} with the element normal.</p> <p>LT.0.0: the absolute value of AOPT is a coordinate system ID number (CID on *DEFINE_COORDINATE_NODES, *DEFINE_COORDINATE_SYSTEM or *DEFINE_COORDINATE_VECTOR). Available in R3 version of 971 and later.</p>
XP, YP, ZP	x_p y_p z_p , define coordinates of point \mathbf{p} for AOPT = 1 and 4.
A1, A2, A3	a_1 a_2 a_3 , define components of vector \mathbf{a} for AOPT = 2.
D1, D2, D3	d_1 d_2 d_3 , define components of vector \mathbf{d} for AOPT = 2.
V1, V2, V3	v_1 v_2 v_3 , define components of vector \mathbf{v} for AOPT = 3 and 4.
BETA	Material angle in degrees for AOPT = 0 and 3, may be overridden on the element card, see *ELEMENT_SHELL_BETA.

Remarks:

If no load curve is defined for the effective stress versus effective plastic strain, the uniaxial stress-strain curve is given on the following form

$$\sigma(\varepsilon_{\text{eff}}^p) = \sigma_0 + Q_{r1}[1 - \exp(-C_{r1}\varepsilon_{\text{eff}}^p)] + Q_{r2}[1 - \exp(-C_{r2}\varepsilon_{\text{eff}}^p)]$$

where $\varepsilon_{\text{eff}}^p$ is the effective plastic strain. For shells the anisotropic behavior is given by R_{00} , R_{45} and R_{90} , or the yield stress in the different direction. Default values are given by:

$$R_{00} = R_{45} = R_{90} = 1$$

if the variables R_{00} , R_{45} , R_{90} , S_{11} , S_{22} , S_{33} and S_{12} are set to zero.

***MAT_DAMAGE_1**

This is Material Type 104. This is a continuum damage mechanics (CDM) model which includes anisotropy and viscoplasticity. The CDM model applies to shell, thick shell, and brick elements. A more detailed description of this model can be found in the paper by Berstad, Hopperstad, Lademo, and Malo [1999]. This material model can also model anisotropic damage behavior by setting the FLAG to -1 in Card 2.

Card 1	1	2	3	4	5	6	7	8
Variable	MID	R0	E	PR	SIGY	LCSS	LCDS	
Type	A8	F	F	F	F			

Card 2	1	2	3	4	5	6	7	8
Variable	Q1	C1	Q2	C2	EPSD	S or EPSR	DC	FLAG
Type	F	F	F	F	F	F	F	F

Card 3	1	2	3	4	5	6	7	8
Variable	VK	VM	R00 or F	R45 or G	R90 or H	L	M	N
Type	F	F	F	F	F	F	F	F

Card 4	1	2	3	4	5	6	7	8
Variable	AOPT			MACF				
Type	F			I				

Card 5	1	2	3	4	5	6	7	8
Variable	XP	YP	ZP	A1	A2	A3		
Type	F	F	F	F	F	F		

Card 6	1	2	3	4	5	6	7	8
Variable	V1	V2	V3	D1	D2	D3	BETA	
Type	F	F	F	F	F	F	F	

VARIABLE**DESCRIPTION**

MID	Material identification. A unique number or label not exceeding 8 characters must be specified.
RO	Mass density.
E	Young's modulus
PR	Poisson's ratio
SIGY	Initial yield stress, σ_0 .
LCSS	Load curve ID. Load curve ID defining effective stress versus effective plastic strain. For FLAG = -1.
LCDS	Load curve ID defining nonlinear damage curve. For FLAG = -1.
Q1	Isotropic hardening parameter Q_1
C1	Isotropic hardening parameter C_1
Q2	Isotropic hardening parameter Q_2
C2	Isotropic hardening parameter C_2
EPSD	Damage threshold r_d Damage effective plastic strain when material softening begins. (Default = 0.0)
S	Damage material constant S. (Default = $\frac{\sigma_0}{200}$). For FLAG ≥ 0 .

VARIABLE	DESCRIPTION
EPSR	Plastic strain at which material ruptures (logarithmic).
DC	Critical damage value D_C . When the damage value D reaches this value, the element is deleted from the calculation. (Default = 0.5) For $FLAG \geq 0$.
FLAG	Flag EQ.-1: Anisotropic damage EQ.0: No calculation of localization due to damage EQ.1: The model flags element where strain localization occur
VK	Viscous material parameter V_k
VM	Viscous material parameter V_m
R00	R_{00} for shell (Default = 1.0)
R45	R_{45} for shell (Default = 1.0)
R90	R_{90} for shell (Default = 1.0)
F	F for brick (Default = 1/2)
G	G for brick (Default = 1/2)
H	H for brick (Default = 1/2)
L	L for brick (Default = 3/2)
M	M for brick (Default = 3/2)
N	N for brick (Default = 3/2)
AOPT	Material axes option (see MAT_OPTIONTROPIC_ELASTIC for a more complete description): EQ.0.0: locally orthotropic with material axes determined by element nodes 1, 2, and 4, as with *DEFINE_COORDINATE_NODES, and then, for shells only, rotated about the shell element normal by an angle BETA. EQ.1.0: locally orthotropic with material axes determined by a point in space and the global location of the element center; this is the a-direction. This option is for solid elements only.

VARIABLE	DESCRIPTION
	<p>EQ.2.0: globally orthotropic with material axes determined by vectors defined below, as with *DEFINE_COORDINATE_VECTOR.</p> <p>EQ.3.0: locally orthotropic material axes determined by rotating the material axes about the element normal by an angle, BETA, from a line in the plane of the element defined by the cross product of the vector v with the element normal.</p> <p>EQ.4.0: locally orthotropic in cylindrical coordinate system with the material axes determined by a vector v, and an originating point, P, which define the centerline axis. This option is for solid elements only.</p> <p>LT.0.0: the absolute value of AOPT is a coordinate system ID number (CID on *DEFINE_COORDINATE_NODES, *DEFINE_COORDINATE_SYSTEM or *DEFINE_COORDINATE_VECTOR). Available in R3 version of 971 and later.</p>
MACF	<p>Material axes change flag for brick elements:</p> <p>EQ.1: No change, default,</p> <p>EQ.2: switch material axes a and b,</p> <p>EQ.3: switch material axes a and c,</p> <p>EQ.4: switch material axes b and c.</p>
XP, YP, ZP	<p>x_p y_p z_p, define coordinates of point p for AOPT = 1 and 4.</p>
A1, A2, A3	<p>a_1 a_2 a_3, define components of vector a for AOPT = 2.</p>
D1, D2, D3	<p>d_1 d_2 d_3, define components of vector d for AOPT = 2.</p>
V1, V2, V3	<p>v_1 v_2 v_3, define components of vector v for AOPT = 3 and 4.</p>
BETA	<p>Material angle in degrees for AOPT = 0 (shells only) and AOPT = 3. BETA may be overridden on the element card, see *ELEMENT_SHELL_BETA and *ELEMENT_SOLID_ORTHO.</p>

Remarks:

Anisotropic Damage model (FLAG = -1). At each thickness integration points, an anisotropic damage law acts on the plane stress tensor in the directions of the principal total shell strains, ε_1 and ε_2 , as follows:

$$\begin{aligned}\sigma_{11} &= [1 - D_1(\varepsilon_1)]\sigma_{110} \\ \sigma_{22} &= [1 - D_2(\varepsilon_2)]\sigma_{220} \\ \sigma_{12} &= \left[1 - \frac{D_1 + D_2}{2}\right]\sigma_{120}\end{aligned}$$

The transverse plate shear stresses in the principal strain directions are assumed to be damaged as follows:

$$\begin{aligned}\sigma_{13} &= (1 - D_1/2)\sigma_{130} \\ \sigma_{23} &= (1 - D_2/2)\sigma_{230}\end{aligned}$$

In the anisotropic damage formulation, $D_1(\varepsilon_1)$ and $D_2(\varepsilon_2)$ are anisotropic damage functions for the loading directions 1 and 2, respectively. Stresses σ_{110} , σ_{220} , σ_{120} , σ_{130} and σ_{230} are stresses in the principal shell strain directions as calculated from the undamaged elastic-plastic material behavior. The strains ε_1 and ε_2 are the magnitude of the principal strains calculated upon reaching the damage thresholds. Damage can only develop for tensile stresses, and the damage functions $D_1(\varepsilon_1)$ and $D_2(\varepsilon_2)$ are identical to zero for negative strains ε_1 and ε_2 . The principal strain directions are fixed within an integration point as soon as either principal strain exceeds the initial threshold strain in tension. A more detailed description of the damage evolution for this material model is given in the description of Material 81.

The Continuum Damage Mechanics (CDM) model (FLAG ≥ 0) is based on a CDM model proposed by Lemaitre [1992]. The effective stress $\tilde{\sigma}$, which is the stress calculated over the section that effectively resist the forces and reads.

$$\tilde{\sigma} = \frac{\sigma}{1 - D}$$

where D is the damage variable. The evolution equation for the damage variable is defined as

$$\dot{D} = \begin{cases} 0 & \text{for } r \leq r_D \\ \frac{Y}{S(1 - D)} \dot{r} & \text{for } r > r_D \text{ and } \sigma_1 > 0 \end{cases}$$

where r_D is the damage threshold, is a positive material constant, S is the so-called strain energy release rate and σ_1 is the maximal principal stress. The strain energy density release rate is

$$Y = \frac{1}{2} \mathbf{e}_e : \mathbf{C} : \mathbf{e}_e = \frac{\sigma_{vm}^2 R_v}{2E(1 - D)^2}$$

where σ_{vm} is the equivalent von Mises stress. The triaxiality function R_v is defined as

$$R_v = \frac{2}{3}(1 + \nu) + 3(1 - 2\nu) \left(\frac{\sigma_H}{\sigma_{vm}} \right)^2.$$

The uniaxial stress-strain curve is given in the following form

$$\sigma(r, \dot{\epsilon}_{\text{eff}}^p) = \sigma_0 + Q_1[1 - \exp(-C_1 r)] + Q_2[1 - \exp(-C_2 r)] + V_k \dot{\epsilon}_{\text{eff}}^p V_m$$

where r is the damage accumulated plastic strain, which can be calculated by

$$\dot{r} = \dot{\epsilon}_{\text{eff}}^p (1 - D)$$

For bricks the following yield criteria is used

$$F(\tilde{\sigma}_{22} - \tilde{\sigma}_{33})^2 + G(\tilde{\sigma}_{33} - \tilde{\sigma}_{11})^2 + H(\tilde{\sigma}_{11} - \tilde{\sigma}_{22})^2 + 2L\tilde{\sigma}_{23}^2 + 2M\tilde{\sigma}_{31}^2 + 2N\tilde{\sigma}_{12}^2 = \sigma(r, \dot{\epsilon}_{\text{eff}}^p)$$

where r is the damage effective viscoplastic strain and $\dot{\epsilon}_{\text{eff}}^p$ is the effective viscoplastic strain rate. For shells the anisotropic behavior is given by the R-values: R_{00} , R_{45} , and R_{90} . When $V_k = 0$ the material will behave as an elastoplastic material without rate effects. Default values for the anisotropic constants are given by:

$$F = G = H = \frac{1}{2}$$

$$L = M = N = \frac{3}{2}$$

$$R_{00} = R_{45} = R_{90} = 1$$

so that isotropic behavior is obtained.

Strain rate is accounted for using the Cowper and Symonds model which scales the yield stress with the factor:

$$1 + \left(\frac{\dot{\epsilon}}{C} \right)^{1/p}$$

To convert these constants, set the viscoelastic constants, V_k and V_m , to the following values:

$$V_k = \sigma \left(\frac{1}{C} \right)^{1/p}$$

$$V_m = \frac{1}{p}$$

***MAT_DAMAGE_2**

This is Material Type 105. This is an elastic viscoplastic material model combined with continuum damage mechanics (CDM). This material model applies to shell, thick shell, and brick elements. The elastoplastic behavior is described in the description of material model 24. A more detailed description of the CDM model is given in the description of material model 104 above.

Card 1	1	2	3	4	5	6	7	8
Variable	MID	R0	E	PR	SIGY	ETAN	FAIL	TDEL
Type	A8	F	F	F	F	F	F	F
Default	none	none	none	none	none	0.0	10.E+20	0

Card 2	1	2	3	4	5	6	7	8
Variable	C	P	LCSS	LCSR				
Type	F	F	F	F				
Default	0	0	0	0				

Card 3	1	2	3	4	5	6	7	8
Variable	EPSD	S	DC					
Type	F	F	F					
Default	none	none	none					

Card 4	1	2	3	4	5	6	7	8
Variable	EPS1	EPS2	EPS3	EPS4	EPS5	EPS6	EPS7	EPS8
Type	F	F	F	F	F	F	F	F
Default	0	0	0	0	0	0	0	0

Card 5	1	2	3	4	5	6	7	8
Variable	ES1	ES2	ES3	ES4	ES5	ES6	ES7	ES8
Type	F	F	F	F	F	F	F	F
Default	0	0	0	0	0	0	0	0

VARIABLE**DESCRIPTION**

MID	Material identification. A unique number or label not exceeding 8 characters must be specified.
RO	Mass density.
E	Young's modulus.
PR	Poisson's ratio.
SIGY	Yield stress.
ETAN	Tangent modulus, ignored if (LCSS.GT.0) is defined.
FAIL	Failure flag. EQ.0.0: Failure due to plastic strain is not considered. GT.0.0: Plastic strain to failure. When the plastic strain reaches this value, the element is deleted from the calculation.
TDEL	Minimum time step size for automatic element deletion.
C	Strain rate parameter, C, see formula below.
P	Strain rate parameter, P, see formula below.

VARIABLE	DESCRIPTION
LCSS	Load curve ID or Table ID. Load curve ID defining effective stress versus effective plastic strain. If defined EPS1 - EPS8 and ES1 - ES8 are ignored. The table ID defines for each strain rate value a load curve ID giving the stress versus effective plastic strain for that rate, See Figure 2-12 . The stress versus effective plastic strain curve for the lowest value of strain rate is used if the strain rate falls below the minimum value. Likewise, the stress versus effective plastic strain curve for the highest value of strain rate is used if the strain rate exceeds the maximum value. The strain rate parameters: C and P; the curve ID, LCSR; EPS1 - EPS8 and ES1 - ES8 are ignored if a Table ID is defined.
LCSR	Load curve ID defining strain rate scaling effect on yield stress.
EPSD	Damage threshold r_d Damage effective plastic strain when material softening begin. (Default = 0.0)
S	Damage material constant S. (Default = $\frac{\sigma_0}{200}$)
DC	Critical damage value D_C . When the damage value D reaches this value, the element is deleted from the calculation. (Default = 0.5)
EPS1 - EPS8	Effective plastic strain values (optional if SIGY is defined). At least 2 points should be defined.
ES1 - ES8	Corresponding yield stress values to EPS1 - EPS8.

Remarks:

The stress-strain behavior may be treated by a bilinear curve by defining the tangent modulus, ETAN. Alternately, a curve similar to that shown in [Figure 2-8](#) is expected to be defined by (EPS1,ES1) - (EPS8,ES8); however, an effective stress versus effective plastic strain curve ID (LCSS) may be input instead if eight points are insufficient. The cost is roughly the same for either approach. The most general approach is to use the table definition with table ID, LCSR, discussed below.

Three options to account for strain rate effects are possible.

1. Strain rate may be accounted for using the Cowper and Symonds model which scales the yield stress with the factor

$$1 + \left(\frac{\dot{\epsilon}}{C}\right)^{1/p}$$

where $\dot{\epsilon}$ is the strain rate, $\dot{\epsilon} = \sqrt{\dot{\epsilon}_{ij}\dot{\epsilon}_{ij}}$

2. For complete generality a load curve (LCSR) to scale the yield stress may be input instead. In this curve the scale factor versus strain rate is defined.
3. If different stress versus strain curves can be provided for various strain rates, the option using the reference to a table (LCSS) can be used. Then the table input in *DEFINE_TABLE has to be used, see [Figure 2-12](#)

A fully viscoplastic formulation is used in this model.

***MAT_ELASTIC_VISCOPLASTIC_THERMAL**

This is Material Type 106. This is an elastic viscoplastic material with thermal effects.

Card 1	1	2	3	4	5	6	7	8
Variable	MID	RO	E	PR	SIGY	ALPHA	LCSS	FAIL
Type	A8	F	F	F	F	F	F	F

Card 2	1	2	3	4	5	6	7	8
Variable	QR1	CR1	QR2	CR2	QX1	CX1	QX2	CX2
Type	F	F	F	F	F	F	F	F

Card 3	1	2	3	4	5	6	7	8
Variable	C	P	LCE	LCPR	LCSIGY	LCR	LCX	LCALPH
Type	F	F	F	F	F	F	F	F

Card 4	1	2	3	4	5	6	7	8
Variable	LCC	LCP	TREF					
Type	F	F	F					

VARIABLE**DESCRIPTION**

MID	Material identification. A unique number or label not exceeding 8 characters must be specified.
RO	Mass density.
E	Young's modulus
PR	Poisson's ratio

VARIABLE	DESCRIPTION
SIGY	Initial yield stress
LCSS	Load curve ID or Table ID. The load curve ID defines effective stress versus effective plastic strain. The table ID defines for each temperature value a load curve ID giving the stress versus effective plastic strain for that temperature (DEFINE_TABLE) or it defines for each temperature value a table ID which defines for each strain rate a load curve ID giving the stress versus effective plastic strain (DEFINE_TABLE_3D). The stress versus effective plastic strain curve for the lowest value of temperature or strain rate is used if the temperature or strain rate falls below the minimum value. Likewise, maximum values cannot be exceeded. Card 2 is ignored with this option.
FAIL	Effective plastic failure strain for erosion of thin shell elements.
ALPHA	Coefficient of thermal expansion.
QR1	Isotropic hardening parameter Q_{r1}
CR1	Isotropic hardening parameter C_{r1}
QR2	Isotropic hardening parameter Q_{r2}
CR2	Isotropic hardening parameter C_{r2}
QX1	Kinematic hardening parameter $Q_{\chi1}$
CX1	Kinematic hardening parameter $C_{\chi1}$
QX2	Kinematic hardening parameter $Q_{\chi2}$
CX2	Kinematic hardening parameter $C_{\chi2}$
C	Viscous material parameter C
P	Viscous material parameter P
LCE	Load curve defining Young's modulus as a function of temperature. E on card 1 is ignored with this option.
LCPR	Load curve defining Poisson's ratio as a function of temperature. PR on card 1 is ignored with this option.
LCSIGY	Load curve defining the initial yield stress as a function of temperature. SIGY on card 1 is ignored with this option.

VARIABLE	DESCRIPTION
LCR	Load curve for scaling the isotropic hardening parameters QR1 and QR2 or the stress given by the load curve LCSS as a function of temperature.
LCX	Load curve for scaling the kinematic hardening parameters QX1 and QX2 as a function of temperature.
LCALPH	Load curve ID defining the instantaneous coefficient of thermal expansion as a function of temperature: $d\varepsilon_{ij}^{\text{thermal}} = \alpha(T)dT\delta_{ij}$ <p>ALPHA on card 1 is ignored with this option. If LCALPH is defined as the negative of the load curve ID, the curve is assumed to define the coefficient relative to a reference temperature, TREF below, such that the total thermal strain is give by</p> $\varepsilon_{ij}^{\text{thermal}} = \alpha(T)(T - T_{\text{ref}})\delta_{ij}$
LCC	Load curve for scaling the viscous material parameter C as a function of temperature.
LCP	Load curve for scaling the viscous material parameter P as a function of temperature.
TREF	Reference temperature required if and only if LCALPH is given with a negative curve ID.

Remarks:

If LCSS is not given any value the uniaxial stress-strain curve has the form

$$\sigma(\varepsilon_{\text{eff}}^p) = \sigma_0 + Q_{r1}[1 - \exp(-C_{r1}\varepsilon_{\text{eff}}^p)] + Q_{r2}[1 - \exp(-C_{r2}\varepsilon_{\text{eff}}^p)] \\ + Q_{\chi1}[1 - \exp(-C_{\chi1}\varepsilon_{\text{eff}}^p)] + Q_{\chi2}[1 - \exp(-C_{\chi2}\varepsilon_{\text{eff}}^p)]$$

Viscous effects are accounted for using the Cowper and Symonds model, which scales the yield stress with the factor:

$$1 + \left(\frac{\dot{\varepsilon}_{\text{eff}}^p}{C}\right)^{1/p}$$

***MAT_MODIFIED_JOHNSON_COOK**

This is Material Type 107.

Define the following two cards with general material parameters

Card 1	1	2	3	4	5	6	7	8
Variable	MID	R0	E	PR	BETA	XS1	CP	ALPHA
Type	A8	F	F	F	F	F	F	F

Card 2	1	2	3	4	5	6	7	8
Variable	E0DOT	Tr	Tm	T0	FLAG1	FLAG2		
Type	F	F	F	F	F	F		

Card 3 for Modified Johnson-Cook Constitutive Relation. This format is used when $FLAG1 = 0$.

Card 3	1	2	3	4	5	6	7	8
Variable	A	B	N	C	m			
Type	F	F	F	F	F			

Card 4 for Modified Johnson-Cook Constitutive Relation. This format is used when $FLAG1 = 0$.

Card 4	1	2	3	4	5	6	7	8
Variable	Q1	C1	Q2	C2				
Type	F	F	F	F				

Card 3 for Modified Zerilli-Armstrong Constitutive Relation. This format is used when FLAG1 = 1.

Card 3	1	2	3	4	5	6	7	8
Variable	SIGA	B	BETA0	BETA1				
Type	F	F	F	F				

Card 4 for Modified Zerilli-Armstrong Constitutive Relation. This format is used when FLAG1 = 1.

Card 4	1	2	3	4	5	6	7	8
Variable	A	N	ALPHA0	ALPHA1				
Type	F	F	F	F				

Card 5 for Modified Johnson-Cook Fracture Criterion. This format is used when FLAG2 = 0.

Card 5	1	2	3	4	5	6	7	8
Variable	DC	PD	D1	D2	D3	D4	D5	
Type	F	F	F	F	F	F	F	

Card 5 for Cockcroft Latham Fracture Criterion. This format is used when FLAG2 = 1.

Card 5	1	2	3	4	5	6	7	8
Variable	DC	WC						
Type	F	F						

Additional Element Erosion Criteria Card.

Card 6	1	2	3	4	5	6	7	8
Variable	TC	TAUC						
Type	F	F						

VARIABLE**DESCRIPTION**

MID	Material identification. A unique number or label not exceeding 8 characters must be specified.
RO	Mass density
E	Young's modulus, E .
PR	Poisson's ratio, ν .
BETA	Damage coupling parameter; see Eq. (107.3). EQ.0.0: No coupling between ductile damage and the constitutive relation. EQ.1.0: Full coupling between ductile damage and the constitutive relation.
XS1	Taylor-Quinney coefficient χ , see Eq. (107.20). Gives the portion of plastic work converted into heat (normally taken to be 0.9)
CP	Specific heat C_p , see Eq. (107.20)
ALPHA	Thermal expansion coefficient, α .
EPS0	Quasi-static threshold strain rate ($\dot{\epsilon}_0 = \dot{p}_0 = \dot{r}_0$), see EQ.(107.12).Set description under *MAT_015.
Tr	Room temperature, see Eq. (107.13)
Tm	Melt temperature, see Eq. (107.13)
T0	Initial temperature

VARIABLE	DESCRIPTION
FLAG1	Constitutive relation flag; see Eq. (107.11) and (107.14) EQ.0.0: Modified Johnson-Cook constitutive relation, see Eq. (107.11). EQ.1.0: Zerilli-Armstrong constitutive relation, see Eq. (107.14).
FLAG2	Fracture criterion flag; see Eq. (107.15) and (107.19). EQ.0.0: Modified Johnson-Cook fracture criterion; see Eq. (107.15). EQ.1.0: Cockcroft-Latham fracture criterion; see Eq. (107.19).
K	Bulk modulus
G	Shear modulus
A	Johnson-Cook yield stress A , see Eq. (107.11).
B	Johnson-Cook hardening parameter B , see Eq. (107.11).
N	Johnson-Cook hardening parameter n , see Eq. (107.11).
C	Johnson-Cook strain rate sensitivity parameter C , see Eq. (107.11).
M	Johnson-Cook thermal softening parameter m , see Eq. (107.11).
Q1	Voce hardening parameter Q_1 (when $B = n = 0$), see Eq. (107.11).
C1	Voce hardening parameter C_1 (when $B = n = 0$), see Eq. (107.11).
Q2	Voce hardening parameter Q_2 (when $B = n = 0$), see Eq. (107.11).
C2	Voce hardening parameter C_2 (when $B = n = 0$), see Eq. (107.11).
SIGA	Zerilli-Armstrong parameter α_n , see Eq. (107.14).
B	Zerilli-Armstrong parameter B , see Eq. (107.14).
BETA0	Zerilli-Armstrong parameter β_0 , see Eq. (107.14).
BETA1	Zerilli-Armstrong parameter β_1 , see Eq. (107.14).
A	Zerilli-Armstrong parameter A , see Eq. (107.14).
N	Zerilli-Armstrong parameter n , see Eq. (107.14).

VARIABLE	DESCRIPTION
ALPHA0	Zerilli-Armstrong parameter α_0 , see Eq. (107.14).
ALPHA1	Zerilli-Armstrong parameter α_1 , see Eq. (107.14).
DC	Critical damage parameter D_c , see Eq. (107.15) and (107.21). When the damage value D reaches this value, the element is eroded from the calculation.
PD	Damage threshold, see Eq. (107.15).
D1-D5	Fracture parameters in the Johnson-Cook fracture criterion, see Eq. (107.16).
WC	Critical Cockcroft-Latham parameter W_c , see Eq. (107.19). When the plastic work per volume reaches this value, the element is eroded from the simulation.
TC	Critical temperature parameter T_c , see Eq. (107.23). When the temperature T , reaches this value, the element is eroded from the simulation.
TAUC	Critical shear stress parameter τ_c . When the maximum shear stress τ reaches this value, the element is eroded from the simulation.

Remarks:

An additive decomposition of the rate-of-deformation tensor \mathbf{d} is assumed, i.e.

$$\mathbf{d} = \mathbf{d}^e + \mathbf{d}^p + \mathbf{d}^t \quad (107.1)$$

Where \mathbf{d}^e is the elastic part, \mathbf{d}^p is the plastic part and \mathbf{d}^t is the thermal part.

The elastic rate-of-deformation \mathbf{d}^e is defined by a linear hypo-elastic relation

$$\tilde{\sigma}^{\nabla J} = \left(K - \frac{2}{3}G \right) \text{tr}(\mathbf{d}^e)\mathbf{I} + 2G\mathbf{d}^e \quad (107.2)$$

Where \mathbf{I} is the unit tensor, K is the bulk modulus and G is the shear modulus. The effective stress tensor is defined by

$$\tilde{\sigma} = \frac{\sigma}{1 - \beta D} \quad (107.3)$$

Where σ is the Cauchy-stress and D is the damage variable, while the Jaumann rate of the effective stress reads

$$\tilde{\sigma}^{\nabla J} = \dot{\tilde{\sigma}} - \mathbf{W} \cdot \tilde{\sigma} - \tilde{\sigma} \cdot \mathbf{W}^T \quad (107.4)$$

Where \mathbf{W} is the spin tensor. The parameter β is equal to unity for coupled damage and equal to zero for uncoupled damage.

The thermal rate-of-deformation \mathbf{d}^T is defined by

$$\mathbf{d}^T = \alpha \dot{T} \mathbf{I} \quad (107.5)$$

Where α is the linear thermal expansion coefficient and T is the temperature.

The plastic rate-of-deformation is defined by the associated flow rule as

$$\mathbf{d}^p = \dot{r} \frac{\partial f}{\partial \tilde{\sigma}} = \frac{3}{2} \frac{\dot{r}}{1 - \beta D} \frac{\tilde{\sigma}'}{\tilde{\sigma}_{\text{eq}}} \quad (107.6)$$

Where $(\cdot)'$ means the deviatoric part of the tensor, r is the damage-equivalent plastic strain, f is the dynamic yield function, i.e.

$$\mathbf{d}^p = \dot{r} \frac{\partial f}{\partial \tilde{\sigma}} = \frac{3}{2} \frac{\dot{r}}{1 - \beta D} \frac{\tilde{\sigma}'}{\tilde{\sigma}_{\text{eq}}} \quad (107.6)$$

$$f = \sqrt{\frac{3}{2} \tilde{\sigma}' : \tilde{\sigma}'} - \sigma_Y(r, \dot{r}, T) \leq 0, \quad \dot{r} \geq 0, \quad \dot{r} f = 0 \quad (107.7)$$

And $\tilde{\sigma}_{\text{eq}}$ is the damage-equivalent stress.

$$\tilde{\sigma}_{\text{eq}} = \sqrt{\frac{3}{2} \tilde{\sigma}' : \tilde{\sigma}'} \quad (107.8)$$

The following plastic work conjugate pairs are identified

$$\dot{W}^p = \sigma : \mathbf{d}^p = \tilde{\sigma}_{\text{eq}} \dot{r} = \sigma_{\text{eq}} \dot{p} \quad (107.9)$$

Where \dot{W}^p is the specific plastic work rate, and the equivalent stress σ_{eq} and the equivalent plastic strain p are defined as

$$\sigma_{\text{eq}} = \sqrt{\frac{3}{2} \tilde{\sigma}' : \tilde{\sigma}'} = (1 - \beta D) \tilde{\sigma}_{\text{eq}} \quad \dot{p} = \sqrt{\frac{2}{3} \mathbf{d}^p : \mathbf{d}^p} = \frac{\dot{r}}{(1 - \beta D)} \quad (107.10)$$

The material strength σ_Y is defined by:

1. The modified Johnson-Cook constitutive relation

$$\sigma_Y = \left\{ A + Br^n + \sum_{i=1}^2 Q_i [1 - \exp(-C_i r)] \right\} (1 + \dot{r}^*)^C (1 - T^m) \quad (107.11)$$

Where $A, B, C, m, n, Q_1, C_1, Q_2, C_2$ are material parameters; the normalized damage-equivalent plastic strain rate \dot{r}^* is defined by

$$\dot{r}^* = \frac{\dot{r}}{\dot{\epsilon}_0} \quad (107.12)$$

In which $\dot{\epsilon}_0$ is a user-defined reference strain rate; and the homologous temperature reads

$$T^* = \frac{T - T_r}{T_m - T_r} \quad (107.13)$$

In which T_r is the room temperature (or initial temperature) and T_m is the melting temperature.

2. The Zerilli-Armstrong constitutive relation

$$\sigma_Y = \{\sigma_a + B \exp[-(\beta_0 - \beta_1 \ln \dot{\epsilon})T] + A r^n \exp[-(\alpha_0 - \alpha_1 \ln \dot{\epsilon})T]\} \quad (107.14)$$

Where $\sigma_a, B, \beta_0, \beta_1, A, n, \alpha_0, \alpha_1$ are material parameters.

Damage evolution is defined by:

1. The extended Johnson-Cook damage evolution rule:

$$\dot{D} = \begin{cases} 0 & p \leq p_d \\ \frac{D_c}{p_f - p_d} & p > p_d \end{cases} \quad (107.15)$$

Where the current equivalent fracture strain $p_f = p_f(\sigma^*, \dot{p}^*, T^*)$ is defined as

$$p_f = [D_1 + D_2 \exp(D_3 \sigma^*)](1 + \dot{p}^*)^{D_4} (1 + D_5 T^*) \quad (107.16)$$

and $D_1, D_2, D_3, D_4, D_5, D_c, p_d$ are material parameters; the normalized equivalent plastic strain rate \dot{p}^* is defined by

$$\dot{p}^* = \frac{\dot{p}}{\dot{\epsilon}_0} \quad (107.17)$$

and the stress triaxiality σ^* reads

$$\sigma^* = \frac{\sigma_H}{\sigma_{eq}}, \quad \sigma_H = \frac{1}{3} \text{tr}(\sigma) \quad (107.18)$$

2. The Cockcroft-Latham damage evolution rule:

$$\dot{D} = \frac{D_C}{W_C} \max(\sigma_1, 0) \dot{p} \quad (107.19)$$

where D_C, W_C are material parameters.

Adiabatic heating is calculated as

$$\dot{T} = \chi \frac{\sigma: \mathbf{d}^p}{\rho C_p} = \chi \frac{\tilde{\sigma}_{eq} \dot{\epsilon}}{\rho C_p} \quad (107.20)$$

Where χ is the Taylor-Quinney parameter, ρ is the density and C_p is the specific heat. The initial value of the temperature T_0 may be specified by the user.

Element erosion occurs when one of the following several criteria are fulfilled:

1. The damage is greater than the critical value

$$D \geq D_C \quad (107.21)$$

2. The maximum shear stress is greater than a critical value

$$\tau_{\max} = \frac{1}{2} \max\{|\sigma_1 - \sigma_2|, |\sigma_2 - \sigma_3|, |\sigma_3 - \sigma_1|\} \geq \tau_C \quad (107.22)$$

3. The temperature is greater than a critical value

$$T \geq T_C \quad (107.23)$$

<i>History Variable</i>	<i>Description</i>
1	Evaluation of damage D
2	Evaluation of stress triaxiality σ^*
3	Evaluation of damaged plastic strain r
4	Evaluation of temperature T
5	Evaluation of damaged plastic strain rate \dot{r}
8	Evaluation of plastic work per volume W
9	Evaluation of maximum shear stress τ_{\max}

***MAT_ORTHO_ELASTIC_PLASTIC**

This is Material Type 108. This model combines orthotropic elastic plastic behavior with an anisotropic yield criterion. This model is implemented only for shell elements.

Card 1	1	2	3	4	5	6	7	8
Variable	MID	RO	E11	E22	G12	PR12	PR23	PR31
Type	A8	F	F	F	F	F	F	F

Card 2	1	2	3	4	5	6	7	8
Variable	SIGMA0	LC	QR1	CR1	QR2	CR2		
Type	F	I	F	F	F	F		

Card 3	1	2	3	4	5	6	7	8
Variable	R11	R22	R33	R12				
Type	F	F	F	F				

Card 4	1	2	3	4	5	6	7	8
Variable	AOPY	BETA						
Type	F	F						

Card 5	1	2	3	4	5	6	7	8
Variable	XP	YP	ZP	A1	A2	A3		
Type	F	F	F	F	F	F		

Card 6	1	2	3	4	5	6	7	8
Variable	V1	V2	V3	D1	D2	D3		
Type	F	F	F	F	F	F		

VARIABLE**DESCRIPTION**

MID	Material identification. A unique number or label not exceeding 8 characters must be specified.
RO	Mass Density
E11	Young's Modulus in 11-direction
E22	Young's Modulus in 22-direction
G12	Shear modulus in 12-direction
PR12	Poisson's ratio 12
PR23	Poisson's ratio 23
PR31	Poisson's ratio 31
LC	Load curve ID. The load curve ID defines effective stress versus effective plastic strain. Values on Card 2 are ignored if this value is defined.
SIGMA0	Initial yield stress, σ_0
QR1	Isotropic hardening parameter, Q_{R1}
CR1	Isotropic hardening parameter, C_{R1}
QR2	Isotropic hardening parameter, Q_{R2}
CR2	Isotropic hardening parameter, C_{R2}
R11	Yield criteria parameter, R_{11}
R22	Yield criteria parameter, R_{22}
R33	Yield criteria parameter, R_{33}
R12	Yield criteria parameter, R_{12}

VARIABLE	DESCRIPTION
AOPT	<p>Material axes option (see MAT_OPTIONTROPIC_ELASTIC for a more complete description)</p> <p>EQ.0.0: Locally orthotropic with material axes determined by element nodes as shown in Figure 2-3. Nodes 1, 2 and 4 of an element are identical to the node used for the definition of a coordinate system as by *DEFINE_COORDINATE_NODES, and then rotated about the shell element normal by an angle BETA.</p> <p>EQ.2.0: Globally orthotropic with material axes determined by vectors defined below, as with *DEFINE_COORDINATE_VECTOR.</p> <p>EQ.3.0: Locally orthotropic material axes determined by offsetting the material axes by an angle, OFFANG, from a line determined by taking the cross product of the vector \mathbf{v} with the normal to the plane of the element.</p> <p>LT.0.0: the absolute value of AOPT is a coordinate system ID number (CID on *DEFINE_COORDINATE_NODES, *DEFINE_COORDINATE_SYSTEM or *DEFINE_COORDINATE_VECTOR). Available in R3 version of 971 and later.</p>
BETA	Material angle in degrees for AOPT = 0 and 3. BETA may be overridden on the element card, see *ELEMENT_SHELL_BETA.
XP YP ZP	Coordinates of point \mathbf{p} for AOPT = 1.
A1 A2 A3	Components of vector \mathbf{a} for AOPT = 2.
V1 V2 V3	Components of vector \mathbf{v} for AOPT = 3.
D1 D2 D3	Components of vector \mathbf{d} for AOPT = 2.

Remarks:

The yield function is defined as

$$f = \bar{f}(\sigma) - [\sigma_0 + R(\epsilon^p)]$$

where the equivalent stress σ_{eq} is defined as an anisotropic yield criterion

$$\sigma_{eq} = \sqrt{F(\sigma_{22} - \sigma_{33})^2 + G(\sigma_{33} - \sigma_{11})^2 + H(\sigma_{11} - \sigma_{22})^2 + 2L\sigma_{23}^2 + 2M\sigma_{31}^2 + 2N\sigma_{12}^2}$$

Where F, G, H, L, M and N are constants obtained by test of the material in different orientations. They are defined as

$$F = \frac{1}{2} \left(\frac{1}{R_{22}^2} + \frac{1}{R_{33}^2} - \frac{1}{R_{11}^2} \right)$$

$$G = \frac{1}{2} \left(\frac{1}{R_{33}^2} + \frac{1}{R_{11}^2} - \frac{1}{R_{22}^2} \right)$$

$$H = \frac{1}{2} \left(\frac{1}{R_{11}^2} + \frac{1}{R_{22}^2} - \frac{1}{R_{33}^2} \right)$$

$$L = \frac{3}{2R_{23}^2}$$

$$M = \frac{3}{2R_{13}^2}$$

$$N = \frac{3}{2R_{31}^2}$$

The yield stress ratios are defined as follows

$$R_{11} = \frac{\bar{\sigma}_{11}}{\sigma_0}$$

$$R_{22} = \frac{\bar{\sigma}_{22}}{\sigma_0}$$

$$R_{33} = \frac{\bar{\sigma}_{33}}{\sigma_0}$$

$$R_{12} = \frac{\bar{\sigma}_{12}}{\tau_0}$$

$$R_{23} = \frac{\bar{\sigma}_{23}}{\tau_0}$$

$$R_{31} = \frac{\bar{\sigma}_{31}}{\tau_0}$$

where σ_{ij} is the measured yield stress values, σ_0 is the reference yield stress and $\tau_0 = \sigma_0 / \sqrt{3}$.

The strain hardening is either defined by the load curve or the strain hardening R is defined by the extended Voce law,

$$R(\varepsilon^p) = \sum_{i=1}^2 Q_{Ri} [1 - \exp(-C_{Ri} \varepsilon^p)]$$

where ϵ^p is the effective (or accumulated) plastic strain, and Q_{Ri} and C_{Ri} are strain hardening parameters.

***MAT_JOHNSON_HOLMQUIST_CERAMICS**

This is Material Type 110. This Johnson-Holmquist Plasticity Damage Model is useful for modeling ceramics, glass and other brittle materials. A more detailed description can be found in a paper by Johnson and Holmquist [1993].

Card 1	1	2	3	4	5	6	7	8
Variable	MID	RO	G	A	B	C	M	N
Type	A8	F	F	F	F	F	F	F

Card 2	1	2	3	4	5	6	7	8
Variable	EPSI	T	SFMAX	HEL	PHEL	BETA		
Type	F	F	F	F	F	F		

Card 3	1	2	3	4	5	6	7	8
Variable	D1	D2	K1	K2	K3	FS		
Type	F	F	F	F	F	F		

VARIABLE**DESCRIPTION**

MID	Material identification. A unique number or label not exceeding 8 characters must be specified.
RO	Density
G	Shear modulus
A	Intact normalized strength parameter
B	Fractured normalized strength parameter
C	Strength parameter (for strain rate dependence)
M	Fractured strength parameter (pressure exponent)

VARIABLE	DESCRIPTION
N	Intact strength parameter (pressure exponent).
EPS0	Quasi-static threshold strain rate. See *MAT_015.
T	Maximum tensile pressure strength.
SFMAX	Maximum normalized fractured strength (if Eq.0, defaults to 1e20).
HEL	Hugoniot elastic limit.
PHEL	Pressure component at the Hugoniot elastic limit.
BETA	Fraction of elastic energy loss converted to hydrostatic energy (affects bulking pressure (history variable 1) that accompanies damage).
D1	Parameter for plastic strain to fracture.
D2	Parameter for plastic strain to fracture (exponent).
K1	First pressure coefficient (equivalent to the bulk modulus).
K2	Second pressure coefficient.
K3	Third pressure coefficient.
FS	Failure criteria. FS.LT.0: fail if $p^* + t^* < 0$ (tensile failure). FS.EQ.0: no failure (default). FS.GT.0: fail if the effective plastic strain $>$ FS.

Remarks:

The equivalent stress for a ceramic-type material is given by

$$\sigma^* = \sigma_i^* - D(\sigma_i^* - \sigma_f^*)$$

where

$$\sigma_i^* = a(p^* + t^*)^n (1 + c \ln \dot{\epsilon}^*)$$

represents the intact, undamaged behavior,

$$D = \sum \frac{\Delta \epsilon^p}{\epsilon_f^p}$$

represents the accumulated damage (history variable 2) based upon the increase in plastic strain per computational cycle and the plastic strain to fracture

$$\varepsilon_f^p = d_1 (p^* + t^*)^{d_2}$$

and

$$\sigma_f^* = b(p^*)^m (1 + c \ln \dot{\varepsilon}) \leq \text{SFMAX}$$

represents the damaged behavior. In each case, the '*' indicates a normalized quantity, the stresses being normalized by the equivalent stress at the Hugoniot elastic limit (see below), the pressures by the pressure at the Hugoniot elastic limit (see below) and the strain rate by the reference strain rate. The parameter d_1 controls the rate at which damage accumulates. If it is made 0, full damage occurs in one time step i.e. instantaneously. It is also the best parameter to vary if one attempts to reproduce results generated by another finite element program.

In undamaged material, the hydrostatic pressure is given by

$$P = k_1 \mu + k_2 \mu^2 + k_3 \mu^3$$

in compression and

$$P = k_1 \mu$$

in tension where $\mu = \rho/\rho_0 - 1$. When damage starts to occur, there is an increase in pressure. A fraction, between 0 and 1, of the elastic energy loss, β , is converted into hydrostatic potential energy (pressure). The details of this pressure increase are given in the reference.

Given hel and g , μ_{hel} can be found iteratively from

$$hel = k_1 \mu_{hel} + k_2 \mu_{hel}^2 + k_3 \mu_{hel}^3 + (4/3)g(\mu_{hel}/(1 + \mu_{hel}))$$

and, subsequently, for normalization purposes,

$$P_{hel} = k_1 \mu_{hel} + k_2 \mu_{hel}^2 + k_3 \mu_{hel}^3$$

and

$$\sigma_{hel} = 1.5(hel - p_{hel})$$

These are calculated automatically by LS-DYNA if ρ_{f0} is zero on input.

***MAT_JOHNSON_HOLMQUIST_CONCRETE**

This is Material Type 111. This model can be used for concrete subjected to large strains, high strain rates and high pressures. The equivalent strength is expressed as a function of the pressure, strain rate, and damage. The pressure is expressed as a function of the volumetric strain and includes the effect of permanent crushing. The damage is accumulated as a function of the plastic volumetric strain, equivalent plastic strain and pressure. A more detailed description of this model can be found in the paper by Holmquist, Johnson, and Cook [1993].

Card 1	1	2	3	4	5	6	7	8
Variable	MID	RO	G	A	B	C	N	FC
Type	A8	F	F	F	F	F	F	F

Card 2	1	2	3	4	5	6	7	8
Variable	T	EPS0	EFMIN	SFMAX	PC	UC	PL	UL
Type	F	F	F	F	F	F	F	F

Card 3	1	2	3	4	5	6	7	8
Variable	D1	D2	K1	K2	K3	FS		
Type	F	F	F	F	F	F		

VARIABLE**DESCRIPTION**

MID	Material identification. A unique number or label not exceeding 8 characters must be specified.
RO	Mass density.
G	Shear modulus.
A	Normalized cohesive strength.
B	Normalized pressure hardening.

VARIABLE	DESCRIPTION
C	Strain rate coefficient.
N	Pressure hardening exponent.
FC	Quasi-static uniaxial compressive strength.
T	Maximum tensile hydrostatic pressure.
EPS0	Quasi-static threshold strain rate. See *MAT_015.
EFMIN	Amount of plastic strain before fracture.
SFMAX	Normalized maximum strength.
PC	Crushing pressure.
UC	Crushing volumetric strain.
PL	Locking pressure.
UL	Locking volumetric strain.
D1	Damage constant.
D2	Damage constant.
K1	Pressure constant.
K2	Pressure constant.
K3	Pressure constant.
FS	Failure type: FS.LT.0: fail if damage strength < 0 FS.EQ.0: fail if $P^* + T^* \leq 0$ (tensile failure). FS.GT.0: fail if the effective plastic strain > FS.

Remarks:

The normalized equivalent stress is defined as

$$\sigma^* = \frac{\sigma}{f'_c}$$

where σ is the actual equivalent stress, and f' is the quasi-static uniaxial compressive strength. The expression is defined as:

$$\sigma^* = [A(1 - D) + BP^{*N}][1 + C \ln(\dot{\epsilon}^*)]$$

where D is the damage parameter, $P^* = P/f'_c$ is the normalized pressure and $\dot{\epsilon}^* = \dot{\epsilon}/\dot{\epsilon}_0$ is the dimensionless strain rate. The model incrementally accumulates damage, D , both from equivalent plastic strain and plastic volumetric strain, and is expressed as

$$D = \sum \frac{\Delta \epsilon_p + \Delta \mu_p}{D_1(P^* + T^*)^{D_2}}$$

where $\Delta \epsilon_p$ and $\Delta \mu_p$ are the equivalent plastic strain and plastic volumetric strain, D_1 and D_2 are material constants and $T^* = T/f'_c$ is the normalized maximum tensile hydrostatic pressure.

The damage strength, DS , is defined in compression when $P^* > 0$ as

$$DS = f'_c \min[SFMAX, A(1 - D) + BP^{*N}][1 + C * \ln(\dot{\epsilon}^*)]$$

or in tension if $P^* < 0$, as

$$DS = f'_c \max\left[0, A(1 - D) - A\left(\frac{P^*}{T}\right)\right][1 + C * \ln(\dot{\epsilon}^*)]$$

The pressure for fully dense material is expressed as

$$P = K_1 \bar{\mu} + K_2 \bar{\mu}^2 + K_3 \bar{\mu}^3$$

where K_1 , K_2 and K_3 are material constants and the modified volumetric strain is defined as

$$\bar{\mu} = \frac{\mu - \mu_{\text{lock}}}{1 + \mu_{\text{lock}}}$$

where μ_{lock} is the locking volumetric strain.

***MAT_FINITE_ELASTIC_STRAIN_PLASTICITY**

This is Material Type 112. An elasto-plastic material with an arbitrary stress versus strain curve and arbitrary strain rate dependency can be defined. The elastic response of this model uses a finite strain formulation so that large elastic strains can develop before yielding occurs. This model is available for solid elements only. See Remarks below.

Card 1	1	2	3	4	5	6	7	8
Variable	MID	RO	E	PR	SIGY	ETAN		
Type	A8	F	F	F	F	F		
Default	none	none	none	none	none	0.0		

Card 2	1	2	3	4	5	6	7	8
Variable	C	P	LCSS	LCSR				
Type	F	F	F	F				
Default	0	0	0	0				

Card 3	1	2	3	4	5	6	7	8
Variable	EPS1	EPS2	EPS3	EPS4	EPS5	EPS6	EPS7	EPS8
Type	F	F	F	F	F	F	F	F
Default	0	0	0	0	0	0	0	0

Card 4	1	2	3	4	5	6	7	8
Variable	ES1	ES2	ES3	ES4	ES5	ES6	ES7	ES8
Type	F	F	F	F	F	F	F	F
Default	0	0	0	0	0	0	0	0

VARIABLE**DESCRIPTION**

MID	Material identification. A unique number or label not exceeding 8 characters must be specified.
RO	Mass density.
E	Young's modulus.
PR	Poisson's ratio.
SIGY	Yield stress.
ETAN	Tangent modulus, ignored if (LCSS.GT.0) is defined.
C	Strain rate parameter, C, see formula below.
P	Strain rate parameter, P, see formula below.
LCSS	Load curve ID or Table ID. Load curve ID defining effective stress versus effective plastic strain. If defined EPS1 - EPS8 and ES1 - ES8 are ignored. The table ID defines for each strain rate value a load curve ID giving the stress versus effective plastic strain for that rate, See Figure 2-12 . The stress versus effective plastic strain curve for the lowest value of strain rate is used if the strain rate falls below the minimum value. Likewise, the stress versus effective plastic strain curve for the highest value of strain rate is used if the strain rate exceeds the maximum value. The strain rate parameters: C and P; the curve ID, LCSR; EPS1 - EPS8 and ES1 - ES8 are ignored if a Table ID is defined.
LCSR	Load curve ID defining strain rate scaling effect on yield stress.

VARIABLE	DESCRIPTION
EPS1 - EPS8	Effective plastic strain values (optional if SIGY is defined). At least 2 points should be defined. The first point must be zero corresponding to the initial yield stress. WARNING: If the first point is non-zero the yield stress is extrapolated to determine the initial yield. If this option is used SIGY and ETAN are ignored and may be input as zero.
ES1 - ES8	Corresponding yield stress values to EPS1 - EPS8.

Remarks:

The stress strain behavior may be treated by a bilinear stress strain curve by defining the tangent modulus, ETAN. Alternately, a curve similar to that shown in [Figure 2-8](#) is expected to be defined by (EPS1,ES1) - (EPS8,ES8); however, an effective stress versus effective plastic strain curve (LCSS) may be input instead if eight points are insufficient. The cost is roughly the same for either approach. The most general approach is to use the table definition (LCSS) discussed below.

Three options to account for strain rate effects are possible.

1. Strain rate may be accounted for using the Cowper and Symonds model which scales the yield stress with the factor

$$1 + \left(\frac{\dot{\epsilon}}{C}\right)^{1/p}$$

where $\dot{\epsilon}$ is the strain rate, $\dot{\epsilon} = \sqrt{\dot{\epsilon}_{ij}\dot{\epsilon}_{ij}}$.

2. For complete generality a load curve (LCSR) to scale the yield stress may be input instead. In this curve the scale factor versus strain rate is defined.
3. If different stress versus strain curves can be provided for various strain rates, the option using the reference to a table (LCSS) can be used. Then the table input in *DEFINE_TABLE has to be used, see [Figure 2-12](#).

***MAT_TRIP**

This is Material Type 113. This isotropic elasto-plastic material model applies to shell elements only. It features a special hardening law aimed at modelling the temperature dependent hardening behavior of austenitic stainless TRIP-steels. TRIP stands for Transformation Induced Plasticity. A detailed description of this material model can be found in Hänsel, Hora, and Reissner [1998] and Schedin, Prentzas, and Hilding [2004].

Card 1	1	2	3	4	5	6	7	8
Variable	MID	RO	E	PR	CP	T0	TREF	TA0
Type	A8	F	F					
Default								

Card 2	1	2	3	4	5	6	7	8
Variable	A	B	C	D	P	Q	EOMART	VM0
Type	F	F						
Default								

Card 3	1	2	3	4	5	6	7	8
Variable	AHS	BHS	M	N	EPS0	HMART	K1	K2
Type								
Default								

VARIABLE**DESCRIPTION**

MID	Material identification. A unique number or label not exceeding 8 characters must be specified.
RO	Mass density.

VARIABLE	DESCRIPTION
E	Young's modulus.
PR	Poisson's ratio.
CP	Adiabatic temperature calculation option: EQ.0.0: Adiabatic temperature calculation is disabled. GT.0.0: CP is the specific heat C_p . Adiabatic temperature calculation is enabled.
T0	Initial temperature T_0 of the material if adiabatic temperature calculation is enabled.
TREF	Reference temperature for output of the yield stress as history variable 1.
TA0	Reference temperature T_{A0} , the absolute zero for the used temperature scale, e.g. -273.15 if the Celsius scale is used and 0.0 if the Kelvin scale is used.
A	Martensite rate equation parameter A , see equations below.
B	Martensite rate equation parameter B , see equations below.
C	Martensite rate equation parameter C , see equations below.
D	Martensite rate equation parameter D , see equations below.
P	Martensite rate equation parameter p , see equations below.
Q	Martensite rate equation parameter Q , see equations below.
E0MART	Martensite rate equation parameter $E_{0(mart)}$, see equations below.
VM0	The initial volume fraction of martensite $0.0 < V_{m0} < 1.0$ may be initialised using two different methods: GT.0.0: V_{m0} is set to VM0. LT.0.0: Can be used only when there are initial plastic strains ϵ^p present, e.g. when using *INITIAL_STRESS_SHELL. The absolute value of VM0 is then the load curve ID for a function f that sets $V_{m0} = f(\epsilon^p)$. The function f must be a monotonically nondecreasing function of ϵ^p .
AHS	Hardening law parameter A_{HS} , see equations below.

VARIABLE	DESCRIPTION
BHS	Hardening law parameter B_{HS} , see equations below.
M	Hardening law parameter m , see equations below.
N	Hardening law parameter n , see equations below.
EPS0	Hardening law parameter ε_0 , see equations below.
HMART	Hardening law parameter $\Delta H_{\gamma \rightarrow \alpha'}$, see equations below.
K1	Hardening law parameter K_1 , see equations below.
K2	Hardening law parameter K_2 , see equations below.

Remarks:

Here a short description is given of the TRIP-material model. The material model uses the von Mises yield surface in combination with isotropic hardening. The hardening is temperature dependent and therefore this material model must be run either in a coupled thermo-mechanical solution, using prescribed temperatures or using the adiabatic temperature calculation option. Setting the parameter CP to the specific heat C_p of the material activates the adiabatic temperature calculation that calculates the temperature rate from the equation

$$\dot{T} = \frac{\sigma D^p}{\rho C_p},$$

where $\sigma \cdot D^p$ is the plastically dissipated heat. Using the Kelvin scale is recommended, even though other scales may be used without problems.

The hardening behavior is described by the following equations. The Martensite rate equation is

$$\frac{\partial V_m}{\partial \bar{\varepsilon}^p} = \begin{cases} 0 & \varepsilon < E_{0(\text{mart})} \\ \frac{B}{A} V_m^p \left(\frac{1 - V_m}{V_m} \right)^{(B+1)/B} \frac{[1 - \tanh(C + D \times T)]}{2} \exp\left(\frac{Q}{T - T_{A0}}\right) & \bar{\varepsilon}^p \geq E_{0(\text{mart})} \end{cases}$$

where

$\bar{\varepsilon}^p$ = effective plastic strain and

T = temperature.

The martensite fraction is integrated from the above rate equation:

$$V_m = \int_0^{\varepsilon} \frac{\partial V_m}{\partial \bar{\varepsilon}^p} d\bar{\varepsilon}^p.$$

It always holds that $0.0 < V_m < 1.0$. The initial martensite content is V_{m0} and must be greater than zero and less than 1.0. Note that V_{m0} is not used during a restart or when initializing the V_m history variable using *INITIAL_STRESS_SHELL.

The yield stress σ_y is

$$\sigma_y = \{B_{HS} - (B_{HS} - A_{HS})\exp(-m[\bar{\varepsilon}^p + \varepsilon_0]^n)\}(K_1 + K_2T) + \Delta H_{\gamma \rightarrow \alpha'} V_m.$$

The parameters p and B should fulfill the following condition

$$\frac{1 + B}{B} < p$$

if not fulfilled then the martensite rate will approach infinity as V_m approaches zero. Setting the parameter ε_0 larger than zero, typical range 0.001-0.02 is recommended. A part from the effective true strain a few additional history variables are output, see below.

History variables that are output for post-processing:

<i>Variable</i>	<i>Description</i>
1	Yield stress of material at temperature TREF. Useful to evaluate the strength of the material after e.g., a simulated forming operation.
2	Volume fraction martensite, V_m
3	CP.EQ.0.0: Not used CP.GT.0.0: Temperature from adiabatic temperature calculation

***MAT_LAYERED_LINEAR_PLASTICITY**

This is Material Type 114. A layered elastoplastic material with an arbitrary stress versus strain curve and an arbitrary strain rate dependency can be defined. This material must be used with the user defined integration rules, see *INTEGRATION-SHELL, for modeling laminated composite and sandwich shells where each layer can be represented by elastoplastic behavior with constitutive constants that vary from layer to layer. Lamination theory is applied to correct for the assumption of a uniform constant shear strain through the thickness of the shell. Unless this correction is applied, the stiffness of the shell can be grossly incorrect leading to poor results. Generally, without the correction the results are too stiff. This model is available for shell elements only. Also, see Remarks below.

Card 1	1	2	3	4	5	6	7	8
Variable	MID	R0	E	PR	SIGY	ETAN	FAIL	TDEL
Type	A8	F	F	F	F	F	F	F
Default	none	none	none	none	none	0.0	10.E+20	0

Card 2	1	2	3	4	5	6	7	8
Variable	C	P	LCSS	LCSR				
Type	F	F	F	F				
Default	0	0	0	0				

Card 3	1	2	3	4	5	6	7	8
Variable	EPS1	EPS2	EPS3	EPS4	EPS5	EPS6	EPS7	EPS8
Type	F	F	F	F	F	F	F	F
Default	0	0	0	0	0	0	0	0

Card 4	1	2	3	4	5	6	7	8
Variable	ES1	ES2	ES3	ES4	ES5	ES6	ES7	ES8
Type	F	F	F	F	F	F	F	F
Default	0	0	0	0	0	0	0	0

VARIABLE**DESCRIPTION**

MID	Material identification. A unique number or label not exceeding 8 characters must be specified.
RO	Mass density.
E	Young's modulus.
PR	Poisson's ratio.
SIGY	Yield stress.
ETAN	Tangent modulus, ignored if (LCSS.GT.0) is defined.
FAIL	Failure flag. LT.0.0: User defined failure subroutine, matusr_24 in dyn21.F, is called to determine failure EQ.0.0: Failure is not considered. This option is recommended if failure is not of interest since many calculations will be saved. GT.0.0: Plastic strain to failure. When the plastic strain reaches this value, the element is deleted from the calculation.
TDEL	Minimum time step size for automatic element deletion.
C	Strain rate parameter, C, see formula below.
P	Strain rate parameter, P, see formula below.

VARIABLE	DESCRIPTION
LCSS	Load curve ID or Table ID. Load curve ID defining effective stress versus effective plastic strain. If defined EPS1 - EPS8 and ES1 - ES8 are ignored. The table ID defines for each strain rate value a load curve ID giving the stress versus effective plastic strain for that rate, See Figure 2-12 . The stress versus effective plastic strain curve for the lowest value of strain rate is used if the strain rate falls below the minimum value. Likewise, the stress versus effective plastic strain curve for the highest value of strain rate is used if the strain rate exceeds the maximum value. The strain rate parameters: C and P; the curve ID, LCSR; EPS1 - EPS8 and ES1 - ES8 are ignored if a Table ID is defined.
LCSR	Load curve ID defining strain rate scaling effect on yield stress.
EPS1 - EPS8	Effective plastic strain values (optional if SIGY is defined). At least 2 points should be defined. The first point must be zero corresponding to the initial yield stress. WARNING: If the first point is non-zero the yield stress is extrapolated to determine the initial yield. If this option is used SIGY and ETAN are ignored and may be input as zero.
ES1 - ES8	Corresponding yield stress values to EPS1 - EPS8.

Remarks:

The stress strain behavior may be treated by a bilinear stress strain curve by defining the tangent modulus, ETAN. Alternately, a curve similar to that shown in [Figure 2-8](#) is expected to be defined by (EPS1, ES1) - (EPS8, ES8); however, an effective stress versus effective plastic strain curve (LCSS) may be input instead if eight points are insufficient. The cost is roughly the same for either approach. The most general approach is to use the table definition (LCSS) discussed below.

Three options to account for strain rate effects are possible.

1. Strain rate may be accounted for using the Cowper and Symonds model which scales the yield stress with the factor

$$1 + \left(\frac{\dot{\epsilon}}{C}\right)^{1/p}$$

where $\dot{\epsilon}$ is the strain rate, $\dot{\epsilon} = \sqrt{\dot{\epsilon}_{ij}\dot{\epsilon}_{ij}}$.

2. For complete generality a load curve (LCSR) to scale the yield stress may be input instead. In this curve the scale factor versus strain rate is defined.
3. If different stress versus strain curves can be provided for various strain rates, the option using the reference to a table (LCSS) can be used. Then the table input in *DEFINE_TABLE has to be used, see [Figure 2-12](#).

***MAT_UNIFIED_CREEP**

This is Material Type 115. This is an elastic creep model for modeling creep behavior when plastic behavior is not considered.

Card 1	1	2	3	4	5	6	7	8
Variable	MID	RO	E	PR	A	N	M	
Type	A8	F	F	F	F	F	F	
Default	none	none	none	none	none	none	none	

VARIABLE**DESCRIPTION**

MID	Material identification. A unique number or label not exceeding 8 characters must be specified.
RO	Mass density.
E	Young's modulus.
PR	Poisson's ratio.
A	Stress coefficient.
N	Stress exponent.
M	Time exponent.

Remarks:

The effective creep strain, $\bar{\epsilon}^c$, given as:

$$\bar{\epsilon}^c = A\bar{\sigma}^n\bar{t}^m$$

where A , n , and m are constants and \bar{t} is the effective time. The effective stress, $\bar{\sigma}$, is defined as:

$$\bar{\sigma} = \sqrt{\frac{3}{2}\sigma_{ij}\sigma_{ij}}$$

The creep strain, therefore, is only a function of the deviatoric stresses. The volumetric behavior for this material is assumed to be elastic. By varying the time constant m primary

creep ($m < 1$), secondary creep ($m = 1$), and tertiary creep ($m > 1$) can be modeled. This model is described by Whirley and Henshall [1992].

***MAT_COMPOSITE_LAYUP**

This is Material Type 116. This material is for modeling the elastic responses of composite layups that have an arbitrary number of layers through the shell thickness. A pre-integration is used to compute the extensional, bending, and coupling stiffness for use with the Belytschko-Tsay resultant shell formulation. The angles of the local material axes are specified from layer to layer in the *SECTION_SHELL input. This material model must be used with the user defined integration rule for shells, see *INTEGRATION_SHELL, which allows the elastic constants to change from integration point to integration point. Since the stresses are not computed in the resultant formulation, the stresses output to the binary databases for the resultant elements are zero. Note that this shell *does not use laminated shell theory* and that storage is allocated for just one integration point (as reported in D3HSP) regardless of the layers defined in the integration rule.

Card 1	1	2	3	4	5	6	7	8
Variable	MID	RO	EA	EB	EC	PRBA	PRCA	PRCB
Type	A8	F	F	F	F	F	F	F

Card 2	1	2	3	4	5	6	7	8
Variable	GAB	GBC	GCA	AOPT				
Type	F	F	F	F				

Card 3	1	2	3	4	5	6	7	8
Variable	XP	YP	ZP	A1	A2	A3		
Type	F	F	F	F	F	F		

Card 4	1	2	3	4	5	6	7	8
Variable	V1	V2	V3	D1	D2	D3	BETA	
Type	F	F	F	F	F	F	F	

VARIABLE	DESCRIPTION
MID	Material identification. A unique number or label not exceeding 8 characters must be specified.
RO	Mass density.
EA	E_a , Young's modulus in a-direction.
EB	E_b , Young's modulus in b-direction.
EC	E_c , Young's modulus in c-direction.
PRBA	ν_{ba} , Poisson's ratio ba.
PRCA	ν_{ca} , Poisson's ratio ca.
PRCB	ν_{cb} , Poisson's ratio cb.
GAB	G_{ab} , shear modulus ab.
GBC	G_{bc} , shear modulus bc.
GCA	G_{ca} , shear modulus ca.
AOPT	Material axes option, see Figure 2-3 : EQ.0.0: locally orthotropic with material axes determined by element nodes as shown in Figure 2-3 . Nodes 1, 2, and 4 of an element are identical to the nodes used for the definition of a coordinate system as by *DEFINE_COORDINATE_NODES, and then rotated about the shell element normal by an angle BETA. EQ.2.0: globally orthotropic with material axes determined by vectors defined below, as with *DEFINE_COORDINATE_VECTOR. EQ.3.0: locally orthotropic material axes determined by rotating the material axes about the element normal by an angle, BETA, from a line in the plane of the element defined by the cross product of the vector v with the element normal. LT.0.0: the absolute value of AOPT is a coordinate system ID number (CID on *DEFINE_COORDINATE_NODES, *DEFINE_COORDINATE_SYSTEM or *DEFINE_COORDINATE_VECTOR). Available in R3 version of 971 and later.

VARIABLE	DESCRIPTION
XP, YP, ZP	Define coordinates of point p for AOPT = 1 and 4.
A1, A2, A3	Define components of vector a for AOPT = 2.
V1, V2, V3	Define components of vector v for AOPT = 3 and 4.
D1, D2, D3	Define components of vector d for AOPT = 2.
BETA	Material angle in degrees for AOPT = 0 and 3, may be overridden on the element card, see *ELEMENT_SHELL_BETA.

Remarks:

This material law is based on standard composite lay-up theory. The implementation, [Jones 1975], allows the calculation of the force, N , and moment, M , stress resultants from:

$$\begin{Bmatrix} N_x \\ N_y \\ N_{xy} \end{Bmatrix} = \begin{bmatrix} A_{11} & A_{12} & A_{16} \\ A_{21} & A_{22} & A_{26} \\ A_{16} & A_{26} & A_{66} \end{bmatrix} \begin{Bmatrix} \varepsilon_x^0 \\ \varepsilon_y^0 \\ \varepsilon_z^0 \end{Bmatrix} + \begin{bmatrix} B_{11} & B_{12} & B_{16} \\ B_{21} & B_{22} & B_{26} \\ B_{16} & B_{26} & B_{66} \end{bmatrix} \begin{Bmatrix} \kappa_x \\ \kappa_y \\ \kappa_z \end{Bmatrix}$$

$$\begin{Bmatrix} M_x \\ M_y \\ M_{xy} \end{Bmatrix} = \begin{bmatrix} B_{11} & B_{12} & B_{16} \\ B_{21} & B_{22} & B_{26} \\ B_{16} & B_{26} & B_{66} \end{bmatrix} \begin{Bmatrix} \varepsilon_x^0 \\ \varepsilon_y^0 \\ \varepsilon_z^0 \end{Bmatrix} + \begin{bmatrix} D_{11} & D_{12} & D_{16} \\ D_{21} & D_{22} & D_{26} \\ D_{16} & D_{26} & D_{66} \end{bmatrix} \begin{Bmatrix} \kappa_x \\ \kappa_y \\ \kappa_z \end{Bmatrix}$$

where A_{ij} is the extensional stiffness, D_{ij} is the bending stiffness, and B_{ij} is the coupling stiffness which is a null matrix for symmetric lay-ups. The mid-surface strains and curvatures are denoted by ε_{ij}^0 and κ_{ij} respectively. Since these stiffness matrices are symmetric, 18 terms are needed per shell element in addition to the shell resultants which are integrated in time. This is considerably less storage than would typically be required with through thickness integration which requires a minimum of eight history variables per integration point, e.g., if 100 layers are used 800 history variables would be stored. Not only is memory much less for this model, but the CPU time required is also considerably reduced.

***MAT_COMPOSITE_MATRIX**

This is Material Type 117. This material is used for modeling the elastic responses of composites where a pre-integration is used to compute the extensional, bending, and coupling stiffness coefficients for use with the Belytschko-Tsay resultant shell formulation. Since the stresses are not computed in the resultant formulation, the stresses output to the binary databases for the resultant elements are zero.

Card 1	1	2	3	4	5	6	7	8
Variable	MID	R0						
Type	A8	F						

Card 2	1	2	3	4	5	6	7	8
Variable	C11	C12	C22	C13	C23	C33	C14	C24
Type	F	F	F	F	F	F	F	F

Card 3	1	2	3	4	5	6	7	8
Variable	C34	C44	C15	C25	C35	C45	C55	C16
Type	F	F	F	F	F	F	F	F

Card 4	1	2	3	4	5	6	7	8
Variable	C26	C36	C46	C56	C66	AOPT		
Type	F	F	F	F	F	F		

Card 5	1	2	3	4	5	6	7	8
Variable	XP	YP	ZP	A1	A2	A3		
Type	F	F	F	F	F	F		

Card 6	1	2	3	4	5	6	7	8
Variable	V1	V2	V3	D1	D2	D3	BETA	
Type	F	F	F	F	F	F	F	

VARIABLE**DESCRIPTION**

MID	Material identification. A unique number or label not exceeding 8 characters must be specified.
RO	Mass density.
CIJ	C_{ij} coefficients of stiffness matrix.
AOPT	Material axes option, see Figure 2-3 : <p>EQ.0.0: locally orthotropic with material axes determined by element nodes as shown in Figure 2-3. Nodes 1, 2, and 4 of an element are identical to the nodes used for the definition of a coordinate system as by *DEFINE_COORDINATE_NODES, and then rotated about the shell element normal by an angle BETA.</p> <p>EQ.2.0: globally orthotropic with material axes determined by vectors defined below, as with *DEFINE_COORDINATE_VECTOR.</p> <p>EQ.3.0: locally orthotropic material axes determined by rotating the material axes about the element normal by an angle, BETA, from a line in the plane of the element defined by the cross product of the vector v with the element normal.</p> <p>LT.0.0: the absolute value of AOPT is a coordinate system ID number (CID on *DEFINE_COORDINATE_NODES, *DEFINE_COORDINATE_SYSTEM or *DEFINE_COORDINATE_VECTOR). Available in R3 version of 971 and</p>

VARIABLE	DESCRIPTION
	later.
XP YP ZP	Define coordinates of point p for AOPT = 1 and 4.
A1 A2 A3	Define components of vector a for AOPT = 2.
V1 V2 V3	Define components of vector v for AOPT = 3 and 4.
D1 D2 D3	Define components of vector d for AOPT = 2.
BETA	Material angle in degrees for AOPT = 0 and 3, may be overridden on the element card, see *ELEMENT_SHELL_BETA.

Remarks:

The calculation of the force, N_{ij} , and moment, M_{ij} , stress resultants is given in terms of the membrane strains, ε_i^0 , and shell curvatures C, κ_i , as:

$$\begin{Bmatrix} N_x \\ N_y \\ N_{xy} \\ M_x \\ M_y \\ M_{xy} \end{Bmatrix} = \begin{bmatrix} C_{11} & C_{12} & C_{13} & C_{14} & C_{15} & C_{16} \\ C_{21} & C_{22} & C_{23} & C_{24} & C_{25} & C_{26} \\ C_{31} & C_{32} & C_{33} & C_{34} & C_{35} & C_{36} \\ C_{41} & C_{42} & C_{43} & C_{44} & C_{45} & C_{46} \\ C_{51} & C_{52} & C_{53} & C_{54} & C_{55} & C_{56} \\ C_{61} & C_{62} & C_{63} & C_{64} & C_{65} & C_{66} \end{bmatrix} \begin{Bmatrix} \varepsilon_x^0 \\ \varepsilon_y^0 \\ \varepsilon_z^0 \\ \kappa_x \\ \kappa_y \\ \kappa_z \end{Bmatrix}$$

where $C_{ij} = C_{ji}$. In this model this symmetric matrix is transformed into the element local system and the coefficients are stored as element history variables. In model type *MAT_COMPOSITE_DIRECT below, the resultants are already assumed to be given in the element local system which reduces the storage since the 21 coefficients are not stored as history variables as part of the element data.

The shell thickness is built into the coefficient matrix and, consequently, within the part ID, which references this material ID, the thickness must be uniform.

***MAT_COMPOSITE_DIRECT**

This is Material Type 118. This material is used for modeling the elastic responses of composites where a pre-integration is used to compute the extensional, bending, and coupling stiffness coefficients for use with the Belytschko-Tsay resultant shell formulation. Since the stresses are not computed in the resultant formulation, the stresses output to the binary databases for the resultant elements are zero.

Card 1	1	2	3	4	5	6	7	8
Variable	MID	RO						
Type	A8	F						

Card 2	1	2	3	4	5	6	7	8
Variable	C11	C12	C22	C13	C23	C33	C14	C24
Type	F	F	F	F	F	F	F	F

Card 3	1	2	3	4	5	6	7	8
Variable	C34	C44	C15	C25	C35	C45	C55	C16
Type	F	F	F	F	F	F	F	F

Card 4	1	2	3	4	5	6	7	8
Variable	C26	C36	C46	C56	C66			
Type	F	F	F	F	F			

VARIABLE**DESCRIPTION**

MID	Material identification. A unique number or label not exceeding 8 characters must be specified.
RO	Mass density.

VARIABLE	DESCRIPTION
CIJ	C_{ij} coefficients of the stiffness matrix.

Remarks:

The calculation of the force, N_{ij} , and moment, M_{ij} , stress resultants is given in terms of the membrane strains, ϵ_i^0 , and shell curvatures, κ_i , as:

$$\begin{Bmatrix} N_x \\ N_y \\ N_{xy} \\ M_x \\ M_y \\ M_{xy} \end{Bmatrix} = \begin{bmatrix} C_{11} & C_{12} & C_{13} & C_{14} & C_{15} & C_{16} \\ C_{21} & C_{22} & C_{23} & C_{24} & C_{25} & C_{26} \\ C_{31} & C_{32} & C_{33} & C_{34} & C_{35} & C_{36} \\ C_{41} & C_{42} & C_{43} & C_{44} & C_{45} & C_{46} \\ C_{51} & C_{52} & C_{53} & C_{54} & C_{55} & C_{56} \\ C_{61} & C_{62} & C_{63} & C_{64} & C_{65} & C_{66} \end{bmatrix} \begin{Bmatrix} \epsilon_x^0 \\ \epsilon_y^0 \\ \epsilon_z^0 \\ \kappa_x \\ \kappa_y \\ \kappa_{xy} \end{Bmatrix}$$

where $C_{ij} = C_{ji}$. In this model the stiffness coefficients are already assumed to be given in the element local system which reduces the storage. Great care in the element orientation and choice of the local element system, see *CONTROL_ACCURACY, must be observed if this model is used.

The shell thickness is built into the coefficient matrix and, consequently, within the part ID, which references this material ID, the thickness must be uniform.

*MAT_119

*MAT_GENERAL_NONLINEAR_6DOF_DISCRETE_BEAM

*MAT_GENERAL_NONLINEAR_6DOF_DISCRETE_BEAM

This is Material Type 119. This is a very general spring and damper model. This beam is based on the MAT_SPRING_GENERAL_NONLINEAR option. Additional unloading options have been included. The two nodes defining the beam may be coincident to give a zero length beam, or offset to give a finite length beam. For finite length discrete beams the absolute value of the variable SCOOR in the SECTION_BEAM input should be set to a value of 2.0 or 3.0 to give physically correct behavior. A triad is used to orient the beam for the directional springs.

Card 1	1	2	3	4	5	6	7	8
Variable	MID	R0	KT	KR	IUNLD	OFFSET	DAMPF	IFLAG
Type	A8	F	F	F	I	F	F	I

Card 2	1	2	3	4	5	6	7	8
Variable	LCIDTR	LCIDTS	LCIDTT	LCIDRR	LCIDRS	LCIDRT		
Type	I	I	I	I	I	I		

Card 3	1	2	3	4	5	6	7	8
Variable	LCIDTUR	LCIDTUS	LCIDTUT	LCIDRUR	LCIDRUS	LCIDRUT		
Type	I	I	I	I	I	I		

Card 4	1	2	3	4	5	6	7	8
Variable	LCIDTDR	LCIDTDS	LCIDTDT	LCIDRDR	LCIDRDS	LCIDRDT		
Type	I	I	I	I	I	I		

Card 5	1	2	3	4	5	6	7	8
Variable	LCIDTER	LCIDTES	LCIDTET	LCIDRER	LCIDRES	LCIDRET		
Type	I	I	I	I	I	I		

Card 6	1	2	3	4	5	6	7	8
Variable	UTFAILR	UTFAILS	UTFAILT	WTFAILR	WTFAILS	WTFALT		
Type	F	F	F	F	F	F		

Card 7	1	2	3	4	5	6	7	8
Variable	UCFAILR	UCFAILS	UCFAILT	WCFAILR	WCFAILS	WCFAILT		
Type	F	F	F	F	F	F		

Card 8	1	2	3	4	5	6	7	8
Variable	IUR	IUS	IUT	IWR	IWS	IWT		
Type	F	F	F	F	F	F		

VARIABLE

DESCRIPTION

- MID Material identification. A unique number or label not exceeding 8 characters must be specified.
- RO Mass density, see also volume in *SECTION_BEAM definition.
- KT Translational stiffness for unloading option 2.0.
- KR Rotational stiffness for unloading option 2.0.

VARIABLE	DESCRIPTION
DAMPF	Damping factor for stability. Values in the neighborhood of unity are recommended. This damping factor is properly scaled to eliminate time step size dependency. Also, it is active if and only if the local stiffness is defined.
IFLAG	Flag for switching between the displacement (default IFLAG = 0) and linear strain (IFLAG = 1) formulations. The displacement formulation is the one used in all other models. For the linear strain formulation, the displacements and velocities are divided by the initial length of the beam.
IUNLD	Unloading option (Also see Figure 2-60): EQ.0.0: Loading and unloading follow loading curve EQ.1.0: Loading follows loading curve, unloading follows unloading curve. The unloading curve ID if undefined is taken as the loading curve. EQ.2.0: Loading follows loading curve, unloading follows unloading stiffness, KT or KR, to the unloading curve. The loading and unloading curves may only intersect at the origin of the axes. EQ.3.0: Quadratic unloading from peak displacement value to a permanent offset.
OFFSET	Offset factor between 0 and 1.0 to determine permanent set upon unloading if the IUNLD = 3.0. The permanent sets in compression and tension are equal to the product of this offset value and the maximum compressive and tensile displacements, respectively.
LCIDTR	Load curve ID defining translational force resultant along local r-axis versus relative translational displacement. If zero, no stiffness related forces are generated for this degree of freedom. The loading curves must be defined from the most negative displacement to the most positive displacement. The force does not need to increase monotonically. The curves in this input are linearly extrapolated when the displacement range falls outside the curve definition.
LCIDTS	Load curve ID defining translational force resultant along local s-axis versus relative translational displacement.
LCIDTT	Load curve ID defining translational force resultant along local t-axis versus relative translational displacement.

VARIABLE	DESCRIPTION
LCIDRR	Load curve ID defining rotational moment resultant about local r-axis versus relative rotational displacement.
LCIDRS	Load curve ID defining rotational moment resultant about local s-axis versus relative rotational displacement.
LCIDRT	Load curve ID defining rotational moment resultant about local t-axis versus relative rotational displacement.
LCIDTUR	Load curve ID defining translational force resultant along local r-axis versus relative translational displacement during unloading. The force values defined by this curve must increase monotonically from the most negative displacement to the most positive displacement. For IUNLD = 1.0, the slope of this curve must equal or exceed the loading curve for stability reasons. This is not the case for IUNLD = 2.0. For loading and unloading to follow the same path simply set LCIDTUR = LCIDTR. For options IUNLD = 0.0 or 3.0 the unloading curve is not required.
LCIDTUS	Load curve ID defining translational force resultant along local s-axis versus relative translational displacement during unloading.
LCIDTUT	Load curve ID defining translational force resultant along local t-axis versus relative translational displacement during unloading.
LCIDRUR	Load curve ID defining rotational moment resultant about local r-axis versus relative rotational displacement during unloading.
LCIDRUS	Load curve ID defining rotational moment resultant about local s-axis versus relative rotational displacement during unloading.
LCIDRUT	Load curve ID defining rotational moment resultant about local t-axis versus relative rotational displacement during unloading. If zero, no viscous forces are generated for this degree of freedom.
LCIDTDR	Load curve ID defining translational damping force resultant along local r-axis versus relative translational velocity.
LCIDTDS	Load curve ID defining translational damping force resultant along local s-axis versus relative translational velocity.
LCIDTDT	Load curve ID defining translational damping force resultant along local t-axis versus relative translational velocity.

VARIABLE	DESCRIPTION
LCIDRDR	Load curve ID defining rotational damping moment resultant about local r-axis versus relative rotational velocity.
LCIDRDS	Load curve ID defining rotational damping moment resultant about local s-axis versus relative rotational velocity.
LCIDRDT	Load curve ID defining rotational damping moment resultant about local t-axis versus relative rotational velocity.
LCIDTER	Load curve ID defining translational damping force scale factor versus relative displacement in local r-direction.
LCIDTES	Load curve ID defining translational damping force scale factor versus relative displacement in local s-direction.
LCIDTET	Load curve ID defining translational damping force scale factor versus relative displacement in local t-direction.
LCIDRER	Load curve ID defining rotational damping moment resultant scale factor versus relative displacement in local r-rotation.
LCIDRES	Load curve ID defining rotational damping moment resultant scale factor versus relative displacement in local s-rotation.
LCIDRET	Load curve ID defining rotational damping moment resultant scale factor versus relative displacement in local t-rotation.
UTFAILR	Optional, translational displacement at failure in tension. If zero, the corresponding displacement, u_r , is not considered in the failure calculation.
UTFAILS	Optional, translational displacement at failure in tension. If zero, the corresponding displacement, u_s , is not considered in the failure calculation.
UTFAILT	Optional, translational displacement at failure in tension. If zero, the corresponding displacement, u_t , is not considered in the failure calculation.
WTFAILR	Optional, rotational displacement at failure in tension. If zero, the corresponding rotation, θ_r , is not considered in the failure calculation.

VARIABLE	DESCRIPTION
WTFAILS	Optional, rotational displacement at failure in tension. If zero, the corresponding rotation, θ_s , is not considered in the failure calculation.
WTFAILT	Optional rotational displacement at failure in tension. If zero, the corresponding rotation, θ_t , is not considered in the failure calculation.
UCFAILR	Optional, translational displacement at failure in compression. If zero, the corresponding displacement, u_r , is not considered in the failure calculation. Define as a positive number.
UCFAILS	Optional, translational displacement at failure in compression. If zero, the corresponding displacement, u_s , is not considered in the failure calculation. Define as a positive number.
UCFAILT	Optional, translational displacement at failure in compression. If zero, the corresponding displacement, u_t , is not considered in the failure calculation. Define as a positive number.
WCFAILR	Optional, rotational displacement at failure in compression. If zero, the corresponding rotation, θ_r , is not considered in the failure calculation. Define as a positive number.
WCFAILS	Optional, rotational displacement at failure in compression. If zero, the corresponding rotation, θ_s , is not considered in the failure calculation. Define as a positive number.
WCFAILT	Optional, rotational displacement at failure in compression. If zero, the corresponding rotation, θ_t , is not considered in the failure calculation. Define as a positive number.
IUR	Initial translational displacement along local r-axis.
IUS	Initial translational displacement along local s-axis.
IUT	Initial translational displacement along local t-axis.
IWR	Initial rotational displacement about the local r-axis.
IWS	Initial rotational displacement about the local s-axis.
IWT	Initial rotational displacement about the local t-axis.

Remarks:

Catastrophic failure, which is based on displacement resultants, occurs if either of the following inequalities are satisfied:

$$\left(\frac{u_r}{u_r^{tfail}}\right)^2 + \left(\frac{u_s}{u_s^{tfail}}\right)^2 + \left(\frac{u_t}{u_t^{tfail}}\right)^2 + \left(\frac{\theta_r}{\theta_r^{tfail}}\right)^2 + \left(\frac{\theta_s}{\theta_s^{tfail}}\right)^2 + \left(\frac{\theta_t}{\theta_t^{tfail}}\right)^2 - 1. \geq 0$$

$$\left(\frac{u_r}{u_r^{cfail}}\right)^2 + \left(\frac{u_s}{u_s^{cfail}}\right)^2 + \left(\frac{u_t}{u_t^{cfail}}\right)^2 + \left(\frac{\theta_r}{\theta_r^{cfail}}\right)^2 + \left(\frac{\theta_s}{\theta_s^{cfail}}\right)^2 + \left(\frac{\theta_t}{\theta_t^{cfail}}\right)^2 - 1. \geq 0$$

After failure the discrete element is deleted. If failure is included either the tension failure or the compression failure or both may be used.

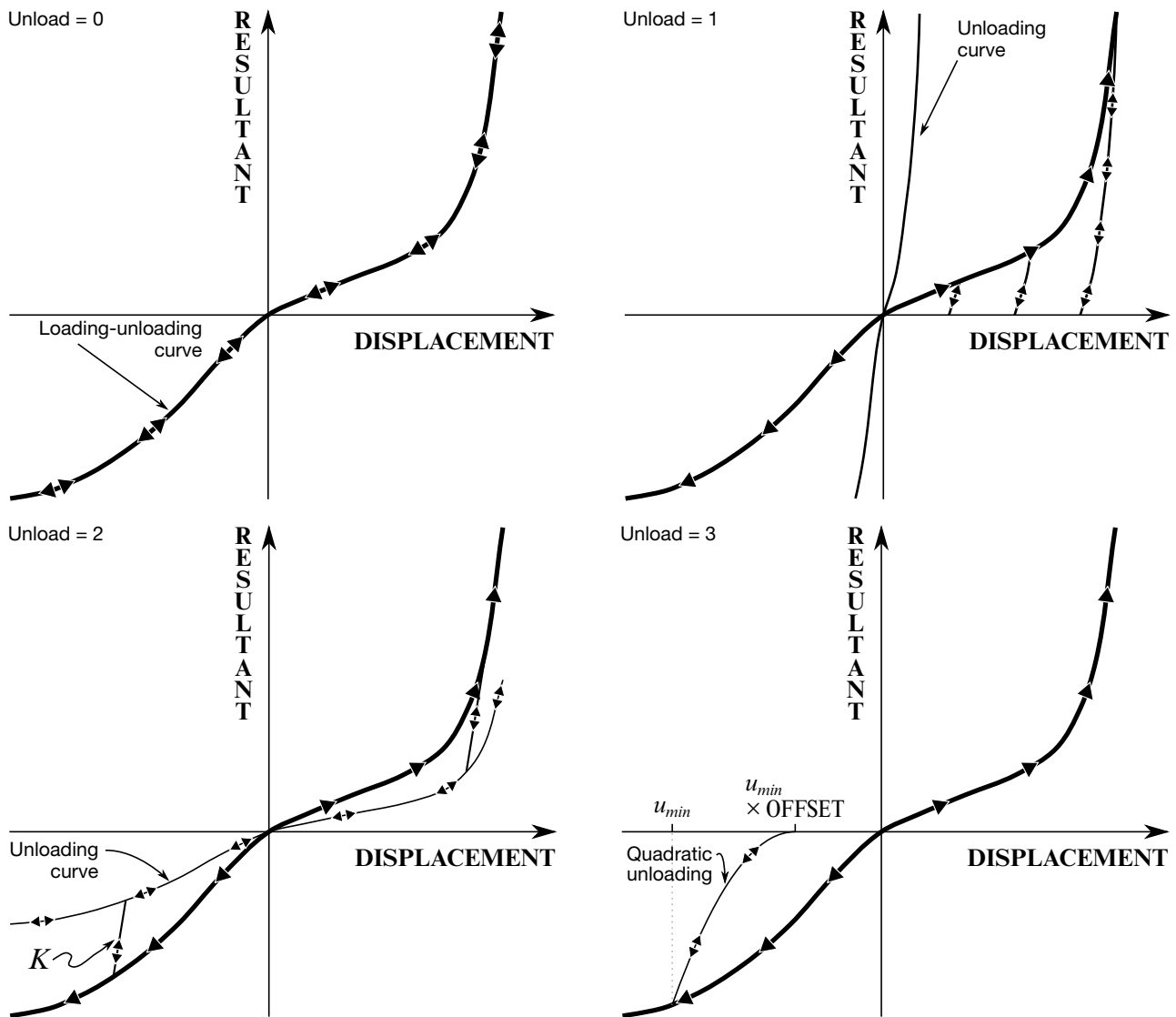

Figure 2-60. Load and unloading behavior.

There are two formulations for calculating the force. The first is the standard displacement formulation, where, for example, the force in a linear spring is

$$F = -K\Delta\ell$$

for a change in length of the beam of $\Delta\ell$. The second formulation is based on the linear strain, giving a force of

$$F = -K\frac{\Delta\ell}{\ell_0}$$

for a beam with an initial length of ℓ_0 . This option is useful when there are springs of different lengths but otherwise similar construction since it automatically reduces the stiffness of the spring as the length increases, allowing an entire family of springs to be modeled with a single material. Note that all the displacement and velocity components are divided by the initial length, and therefore the scaling applies to the damping and rotational stiffness.

***MAT_GURSON**

This is Material Type 120. This is the Gurson dilatational-plastic model. This model is available for shell and solid elements. A detailed description of this model can be found in the following references: Gurson [1975, 1977], Chu and Needleman [1980] and Tvergaard and Needleman [1984]. The implementation in LS-DYNA is based on the implementation of Feucht [1998] and Faßnacht [1999], which was recoded at LSTC. Strain rate dependency can be defined via a Table definition.

Card 1	1	2	3	4	5	6	7	8
Variable	MID	RO	E	PR	SIGY	N	Q1	Q2
Type	A8	F	F	F	F	F	F	F
Default	none	none	none	none	none	0.0	none	none

Card 2	1	2	3	4	5	6	7	8
Variable	FC	F0	EN	SN	FN	ETAN	ATYP	FF0
Type	F	F	F	F	F	F	F	F
Default	0	0	0	0	0	0	0	0

Card 3	1	2	3	4	5	6	7	8
Variable	EPS1	EPS2	EPS3	EPS4	EPS5	EPS6	EPS7	EPS8
Type	F	F	F	F	F	F	F	F
Default	0	0	0	0	0	0	0	0

Card 4	1	2	3	4	5	6	7	8
Variable	ES1	ES2	ES3	ES4	ES5	ES6	ES7	ES8
Type	F	F	F	F	F	F	F	F
Default	0	0	0	0	0	0	0	0

Card 5	1	2	3	4	5	6	7	8
Variable	L1	L2	L3	L4	FF1	FF2	FF3	FF4
Type	F	F	F	F	F	F	F	F
Default	0	0	0	0	0	0	0	0

Card 6	1	2	3	4	5	6	7	8
Variable	LCSS	LCLF	NUMINT	LCFO	LCFC	LCFN	VG Typ	DEXP
Type	F	F	F	F	F	F	F	F
Default	0	0	1.0	0	0	0	0	3.0

VARIABLE**DESCRIPTION**

MID	Material identification. A unique number or label not exceeding 8 characters must be specified.
RO	Mass density.
E	Young's modulus.
PR	Poisson's ratio.
SIGY	Yield stress.
N	Exponent for Power law. This value is only used if ATYP = 1 and LCSS = 0.

VARIABLE	DESCRIPTION
Q1	Gurson flow function parameter q_1 .
Q2	Gurson flow function parameter q_2 .
FC	Critical void volume fraction f_c where voids begin to aggregate. This value is only used if LCFC = 0.
F0	Initial void volume fraction f_0 . This value is only used if LCF0 = 0.
EN	Mean nucleation strain ε_N .
SN	Standard deviation s_N of the normal distribution of ε_N .
FN	Void volume fraction of nucleating particles f_N . This value is only used if LCFN = 0.
ETAN	Hardening modulus. This value is only used if ATYP = 2 and LCSS = 0.
ATYP	Type of hardening. EQ.1.0: Power law. EQ.2.0: Linear hardening. EQ.3.0: 8 points curve.
FF0	Failure void volume fraction f_F . This value is only used if no curve is given by (L1, FF1) – (L4, FF4) and LCFF = 0.
EPS1 - EPS8	Effective plastic strain values. The first point must be zero corresponding to the initial yield stress. At least 2 points should be defined. These values are used if ATYP = 3 and LCSS = 0.
ES1 - ES8	Corresponding yield stress values to EPS1 – EPS8. These values are used if ATYP = 3 and LCSS = 0.
L1 - L4	Element length values. These values are only used if LCFF = 0
FF1 - FF4	Corresponding failure void volume fraction. These values are only used if LCFF = 0.

VARIABLE	DESCRIPTION
LCSS	Load curve ID or Table ID. ATYP is ignored with this option. Load curve ID defining effective stress versus effective plastic strain. Table ID defines for each strain rate value a load curve ID giving the effective stress versus effective plastic strain for that rate (see MAT_024). The stress-strain curve for the lowest value of strain rate is used if the strain rate falls below the minimum value. Likewise, the stress-strain curve for the highest value of strain rate is used if the strain rate exceeds the maximum value. <u>NOTE</u> : The strain rate values defined in the table may be given as the natural logarithm of the strain rate. If the <i>first</i> stress-strain curve in the table corresponds to a negative strain rate, LS-DYNA assumes that the natural logarithm of the strain rate value is used. Since the tables are internally discretized to equally space the points, natural logarithms are necessary, for example, if the curves correspond to rates from 10.e-04 to 10.e+04.
LCFF	Load curve ID defining failure void volume fraction f_F versus element length.
NUMINT	Number of integration points which must fail before the element is deleted. This option is available for shells and solids. LT.0.0: NUMINT is percentage of integration points/layers which must fail before shell element fails. For fully integrated shells, a methodology is used where a layer fails if one integration point fails and then the given percentage of layers must fail before the element fails. Only available for shells.
LCF0	Load curve ID defining initial void volume fraction f_0 versus element length.
LCFC	Load curve ID defining critical void volume fraction f_c versus element length.
LCFN	Load curve ID defining void volume fraction of nucleating particles f_N versus element length.

VARIABLE	DESCRIPTION
VGTYPE	Type of void growth behavior. EQ.0.0: Void growth in case of tension and void contraction in case of compression, but never below f_0 (default). EQ.1.0: Void growth only in case of tension. EQ.2.0: Void growth in case of tension and void contraction in case of compression, even below f_0 .
DEXP	Exponent value for damage history variable 16.

Remarks:

The Gurson flow function is defined as:

$$\Phi = \frac{\sigma_M^2}{\sigma_Y^2} + 2q_1 f^* \cosh\left(\frac{3q_2 \sigma_H}{2\sigma_Y}\right) - 1 - (q_1 f^*)^2 = 0$$

where σ_M is the equivalent von Mises stress, σ_Y is the yield stress, σ_H is the mean hydrostatic stress. The effective void volume fraction is defined as

$$f^*(f) = \begin{cases} f & f \leq f_c \\ f_c + \frac{1/q_1 - f_c}{f_F - f_c} (f - f_c) & f > f_c \end{cases}$$

The growth of void volume fraction is defined as

$$\dot{f} = \dot{f}_G + \dot{f}_N$$

where the growth of existing voids is defined as

$$\dot{f}_G = (1 - f) \dot{\epsilon}_{kk}^p$$

and nucleation of new voids is defined as

$$\dot{f}_N = A \dot{\epsilon}_p$$

with function A

$$A = \frac{f_N}{S_N \sqrt{2\pi}} \exp\left(-\frac{1}{2} \left(\frac{\epsilon_p - \epsilon_N}{S_N}\right)^2\right)$$

Voids are nucleated only in tension.

History variables:*Shell / Solid Description*

1 / 1	Void volume fraction
4 / 2	Triaxiality variable σ_H/σ_M
5 / 3	Effective strain rate
6 / 4	Growth of voids
7 / 5	Nucleation of voids
11 / 11	Dimensionless material damage value = $\begin{cases} \frac{(f-f_0)}{(f_c-f_0)} & \text{if } f \leq f_c \\ 1 + \frac{(f-f_c)}{(f_F-f_c)} & \text{if } f > f_c \end{cases}$
13 / 13	Deviatoric part of microscopic plastic strain
14 / 14	Volumetric part of macroscopic plastic strain
16 / 16	Dimensionless material damage value = $\left(\frac{f-f_0}{f_F-f_0}\right)^{1/DEXP}$

***MAT_GURSON_JC**

This is an enhancement of Material Type 120. This is the Gurson model with additional Johnson-Cook failure criterion (parameters Card 5). This model is available for shell and solid elements. Strain rate dependency can be defined via a table. An extension for void growth under shear-dominated states and for Johnson-Cook damage evolution is optional.

Card 1	1	2	3	4	5	6	7	8
Variable	MID	R0	E	PR	SIGY	N	Q1	Q2
Type	A8	F	F	F	F	F	F	F
Default	none	none	none	none	none	0.0	none	none

Card 2	1	2	3	4	5	6	7	8
Variable	FC	F0	EN	SN	FN	ETAN	ATYP	FF0
Type	F	F	F	F	F	F	F	F
Default	0	0	0	0	0	0	0	0

Card 3	1	2	3	4	5	6	7	8
Variable	EPS1	EPS2	EPS3	EPS4	EPS5	EPS6	EPS7	EPS8
Type	F	F	F	F	F	F	F	F
Default	0	0	0	0	0	0	0	0

Card 4	1	2	3	4	5	6	7	8
Variable	SIG1	SIG2	SIG3	SIG4	SIG5	SIG6	SIG7	SIG8
Type	F	F	F	F	F	F	F	F
Default	0	0	0	0	0	0	0	0

Card 5	1	2	3	4	5	6	7	8
Variable	LCDAM	L1	L2	D1	D2	D3	D4	LCJC
Type	F	F	F	F	F	F	F	F
Default	0	0	0	0	0	0	0	0

Card 6	1	2	3	4	5	6	7	8
Variable	LCSS	LCFF	NUMINT	LCF0	LCFC	LCFN	VG Typ	DEXP
Type	F	F	F	F	F	F	F	F
Default	0	0	1	0	0	0	0	3.0

Optional Card (starting with version 971 release R4)

Card 7	1	2	3	4	5	6	7	8
Variable	KW	BETA	M					
Type	F	F	F					
Default	0	0	1.0					

VARIABLE	DESCRIPTION
MID	Material identification. A unique number or label not exceeding 8 characters must be specified.
RO	Mass density.
E	Young's modulus.
PR	Poisson's ratio.
SIGY	Yield stress.
N	Exponent for Power law. This value is only used if ATYP = 1 and LCSS = 0.
Q1	Gurson flow function parameter q_1 .
Q2	Gurson flow function parameter q_2 .
FC	Critical void volume fraction f_c where voids begin to aggregate.
F0	Initial void volume fraction f_0 . This value is only used if LCF0 = 0.
EN	Mean nucleation strain ε_N .
SN	Standard deviation s_N of the normal distribution of ε_N .
FN	Void volume fraction of nucleating particles f_N . This value is only used if LCFN = 0.
ETAN	Hardening modulus. This value is only used if ATYP = 2 and LCSS = 0.
ATYP	Type of hardening. EQ.1.0: Power law. EQ.2.0: Linear hardening. EQ.3.0: 8 points curve.
FF0	Failure void volume fraction f_F . This value is only used if LCFF = 0.
EPS1 - EPS8	Effective plastic strain values. The first point must be zero corresponding to the initial yield stress. At least 2 points should be defined. These values are used if ATYP = 3 and LCSS = 0.

VARIABLE	DESCRIPTION
ES1 - ES8	Corresponding yield stress values to EPS1 – EPS8. These values are used if ATYP = 3 and LCSS = 0.
LCDAM	Load curve defining scaling factor Λ versus element length. Scales the Johnson-Cook failure strain (see remarks). If LCDAM = 0, no scaling is performed.
L1	Lower triaxiality factor defining failure evolution (Johnson-Cook).
L2	Upper triaxiality factor defining failure evolution (Johnson-Cook).
D1 - D4	Johnson-Cook damage parameters.
LCJC	Load curve defining scaling factor for Johnson-Cook failure versus triaxiality (see remarks). If LCJC > 0, parameters D1, D2 and D3 are ignored.
LCSS	Load curve ID or Table ID. ATYP is ignored with this option. Load curve ID defining effective stress versus effective plastic strain. Table ID defines for each strain rate value a load curve ID giving the effective stress versus effective plastic strain for that rate (see MAT_024). The stress-strain curve for the lowest value of strain rate is used if the strain rate falls below the minimum value. Likewise, the stress-strain curve for the highest value of strain rate is used if the strain rate exceeds the maximum value. NOTE: The strain rate values defined in the table may be given as the natural logarithm of the strain rate. If the <i>first</i> stress-strain curve in the table corresponds to a negative strain rate, LS-DYNA assumes that the natural logarithm of the strain rate value is used. Since the tables are internally discretized to equally space the points, natural logarithms are necessary, for example, if the curves correspond to rates from 10.e-04 to 10.e+04.
LCFF	Load curve ID defining failure void volume fraction f_F versus element length.

VARIABLE	DESCRIPTION
NUMINT	<p>Number of through thickness integration points which must fail before the element is deleted. This option is available for shells and solids.</p> <p>LT.0.0: NUMINT is percentage of integration points/layers which must fail before shell element fails. For fully integrated shells, a methodology is used where a layer fails if one integration point fails and then the given percentage of layers must fail before the element fails. Only available for shells.</p>
LCF0	Load curve ID defining initial void volume fraction f_0 versus element length.
LCFC	Load curve ID defining critical void volume fraction f_c versus element length.
LCFN	Load curve ID defining void volume fraction of nucleating particles f_N versus element length.
VGTYPE	<p>Type of void growth behavior.</p> <p>EQ.0.0: Void growth in case of tension and void contraction in case of compression, but never below f_0 (default).</p> <p>EQ.1.0: Void growth only in case of tension.</p> <p>EQ.2.0: Void growth in case of tension and void contraction in case of compression, even below f_0.</p>
DEXP	Exponent value for damage history variable 16.
KW	Parameter k_w for void growth in shear-dominated states. See remarks.
BETA	Parameter β in Lode cosine function. See remarks.
M	Parameter for generalization of Johnson-Cook damage evolution. See remarks.

Remarks:

The Gurson flow function is defined as:

$$\Phi = \frac{\sigma_M^2}{\sigma_Y^2} + 2q_1 f^* \cosh\left(\frac{3q_2 \sigma_H}{2\sigma_Y}\right) - 1 - (q_1 f^*)^2 = 0$$

where σ_M is the equivalent von Mises stress, σ_Y is the yield stress, σ_H is the mean hydrostatic stress. The effective void volume fraction is defined as

$$f^*(f) = \begin{cases} f & f \leq f_c \\ f_c + \frac{1/q_1 - f_c}{f_F - f_c} (f - f_c) & f > f_c \end{cases}$$

The growth of void volume fraction is defined as

$$\dot{f} = \dot{f}_G + \dot{f}_N$$

where the growth of existing voids is defined as

$$\dot{f}_G = (1 - f) \dot{\epsilon}_{kk}^p + k_\omega \omega(\sigma) f (1 - f) \dot{\epsilon}_M^{pl} \frac{\sigma_Y}{\sigma_M}$$

The second term is an optional extension for shear failure proposed by Nahshon and Hutchinson [2008] with new parameter k_ω ($=0$ by default), effective plastic strain rate in the matrix $\dot{\epsilon}_M^{pl}$, and Lode cosin function $\omega(\sigma)$:

$$\omega(\sigma) = 1 - \zeta^2 - \beta \cdot \zeta(1 - \zeta), \quad \zeta = \cos(3\theta) = \frac{27}{2} \frac{J_3}{\sigma_M^3}$$

with parameter β , Lode angle θ and third deviatoric stress invariant J_3 .

Nucleation of new voids is defined as

$$\dot{f}_N = A \dot{\epsilon}_M^{pl}$$

with function A

$$A = \frac{f_N}{S_N \sqrt{2\pi}} \exp \left[-\frac{1}{2} \left(\frac{\epsilon_M^{pl} - \epsilon_N}{S_N} \right)^2 \right]$$

Voids are nucleated only in tension.

The Johnson-Cook failure criterion is added in this material model. Based on the triaxiality ratio σ_H/σ_M failure is calculated as:

$$\sigma_H/\sigma_M > L_1 \quad : \text{Gurson model}$$

$$L_1 \geq \sigma_H/\sigma_M \geq L_2 \quad : \text{Gurson model and Johnson-Cook failure criteria}$$

$$\sigma_H/\sigma_M < L_2 \quad : \text{Gurson model}$$

Johnson-Cook failure strain is defined as

$$\epsilon_f = \left[D_1 + D_2 \exp \left(D_3 \frac{\sigma_H}{\sigma_M} \right) \right] (1 + D_4 \ln \dot{\epsilon}) \Lambda$$

where D_1, D_2, D_3 and D_4 are the Johnson-Cook failure parameters and Λ is a function for including mesh-size dependency. An alternative expression can be used, where the first

term of the above equation (including D1, D2 and D3) is replaced by a general function LCJC which depends on triaxiality

$$\epsilon_f = LCJC \left(\frac{\sigma_H}{\sigma_M} \right) (1 + D_4 \ln \dot{\epsilon}) \Lambda$$

The Johnson-Cook damage parameter D_f is calculated with the following evolution

$$\dot{D}_f = \frac{\dot{\epsilon}^{pl}}{\epsilon_f} \rightarrow D_f = \sum \frac{\Delta \epsilon^{pl}}{\epsilon_f} \begin{cases} < 1 & \text{no failure} \\ \geq 1 & \text{failure} \end{cases}$$

where $\Delta \epsilon^{pl}$ is the increment in effective plastic strain. A more general (non-linear) damage evolution is possible if $M > 1$ is chosen:

$$\dot{D}_f = \frac{M}{\epsilon_f} D_f^{(1-\frac{1}{M})} \dot{\epsilon}^{pl}, \quad M \geq 1.0$$

History variables:

Shell / Solid Description

- 1 / 1 Void volume fraction
- 4 / 2 Triaxiality variable σ_H/σ_M
- 5 / 3 Effective strain rate
- 6 / 4 Growth of voids
- 7 / 5 Nucleation of voids
- 8 / 6 Johnson-Cook failure strain ϵ_f
- 9 / 7 Johnson-Cook damage parameter D_f
- 0 / 8 Domain variable:

- EQ.0 \Rightarrow elastic stress update
- EQ.1 \Rightarrow region (a) Gurson
- EQ.2 \Rightarrow region (b) Gurson + Johnson-Cook
- EQ.3 \Rightarrow region (c) Gurson

11 / 11 Dimensionless material damage value = $\begin{cases} \frac{(f-f_0)}{(f_c-f_0)} & \text{if } f \leq f_c \\ 1 + \frac{(f-f_c)}{(f_F-f_c)} & \text{if } f > f_c \end{cases}$

13 / 13 Deviatoric part of microscopic plastic strain

14 / 14 Volumetric part of macroscopic plastic strain

16 / 16 Dimensionless material damage value = $\left(\frac{f-f_0}{f_F-f_0} \right)^{1/DEXP}$

***MAT_GURSON_RCDC**

This is an enhancement of material Type 120. This is the Gurson model with the Wilkins Rc-Dc [Wilkins, et al., 1977] fracture model added. This model is available for shell and solid elements. A detailed description of this model can be found in the following references: Gurson [1975, 1977]; Chu and Needleman [1980]; and Tvergaard and Needleman [1984].

Card 1	1	2	3	4	5	6	7	8
Variable	MID	R0	E	PR	SIGY	N	Q1	Q2
Type	A8	F	F	F	F	F	F	F
Default	none	none	none	none	none	0.0	none	none

Card 2	1	2	3	4	5	6	7	8
Variable	FC	F0	EN	SN	FN	ETAN	ATYP	FF0
Type	F	F	F	F	F	F	F	F
Default	0	0	0	0	0	0	0	0

Card 3	1	2	3	4	5	6	7	8
Variable	EPS1	EPS2	EPS3	EPS4	EPS5	EPS6	EPS7	EPS8
Type	F	F	F	F	F	F	F	F
Default	0	0	0	0	0	0	0	0

MAT_120_RCDC**MAT_GURSON_RCDC**

Card 4	1	2	3	4	5	6	7	8
Variable	ES1	ES2	ES3	ES4	ES5	ES6	ES7	ES8
Type	F	F	F	F	F	F	F	F
Default	0	0	0	0	0	0	0	0

Card 5	1	2	3	4	5	6	7	8
Variable	L1	L2	L3	L4	FF1	FF2	FF3	FF4
Type	F	F	F	F	F	F	F	F
Default	0	0	0	0	0	0	0	0

Card 6	1	2	3	4	5	6	7	8
Variable	LCSS	LCLF	NUMINT					
Type	F	F	F					
Default	0	0	1					

Card 7	1	2	3	4	5	6	7	8
Variable	ALPHA	BETA	GAMMA	D0	B	LAMBDA	DS	L
Type	F	F	F	F	F	F	F	F
Default	0	0	0	0	0	0	0	0

VARIABLE	DESCRIPTION
MID	Material identification. A unique number or label not exceeding 8 characters must be specified.
RO	Mass density.
E	Young's modulus.
PR	Poisson's ratio.
SIGY	Yield stress.
N	Exponent for Power law. This value is only used if ATYP = 1 and LCSS = 0.
Q1	Parameter q_1 .
Q1	Parameter q_2 .
FC	Critical void volume fraction f_c
F0	Initial void volume fraction f_0 .
EN	Mean nucleation strain ε_N .
SN	Standard deviation S_N of the normal distribution of ε_N .
FN	Void volume fraction of nucleating particles.
ETAN	Hardening modulus. This value is only used if ATYP = 2 and LCSS = 0.
ATYP	Type of hardening. EQ.1.0: Power law. EQ.2.0: Linear hardening. EQ.3.0: 8 points curve.
FF0	Failure void volume fraction. This value is used if no curve is given by the points (L1, FF1) – (L4, FF4) and LCLF = 0.
EPS1 - EPS8	Effective plastic strain values. The first point must be zero corresponding to the initial yield stress. This option is only used if ATYP equal to 3. At least 2 points should be defined. These values are used if ATYP = 3 and LCSS = 0.

VARIABLE	DESCRIPTION
ES1 - ES8	Corresponding yield stress values to EPS1 - EPS8. These values are used if ATYP = 3 and LCSS = 0.
L1 - L4	Element length values. These values are only used if LCLF = 0.
FF1 - FF4	Corresponding failure void volume fraction. These values are only used if LCLF = 0.
LCSS	Load curve ID defining effective stress versus effective plastic strain. ATYP is ignored with this option.
LCLF	Load curve ID defining failure void volume fraction versus element length. The values L1 - L4 and FF1 - FF4 are ignored with this option.
NUMINT	Number of through thickness integration points which must fail before the element is deleted.
ALPHA	Parameter α . for the Rc-Dc model
BETA	Parameter β . for the Rc-Dc model
GAMMA	Parameter γ . for the Rc-Dc model
D0	Parameter D_0 . for the Rc-Dc model
B	Parameter b . for the Rc-Dc model
LAMBDA	Parameter λ . for the Rc-Dc model
DS	Parameter D_s . for the Rc-Dc model
L	Characteristic element length for this material

Remarks:

The Gurson flow function is defined as:

$$\Phi = \frac{\sigma_M^2}{\sigma_Y^2} + 2q_1 f^* \cosh\left(\frac{3q_2 \sigma_H}{2\sigma_Y}\right) - 1 - (q_1 f^*)^2 = 0$$

where σ_M is the equivalent von Mises stress, σ_Y is the Yield stress, σ_H is the mean hydrostatic stress. The effective void volume fraction is defined as

$$f^*(f) = \begin{cases} f & f \leq f_c \\ f_c + \frac{1/q_1 - f_c}{f_F - f_c} (f - f_c) & f > f_c \end{cases}$$

The growth of the void volume fraction is defined as

$$\dot{f} = \dot{f}_G + \dot{f}_N$$

where the growth of existing voids is given as:

$$\dot{f}_G = (1 - f) \dot{\varepsilon}_{kk}^p,$$

and nucleation of new voids as:

$$\dot{f}_N = A \dot{\varepsilon}_p$$

in which A is defined as

$$A = \frac{f_N}{S_N \sqrt{2\pi}} \exp\left(-\frac{1}{2} \left(\frac{\varepsilon_p - \varepsilon_N}{S_N}\right)^2\right)$$

The Rc-Dc model is defined as the following:

The damage D is given by

$$D = \int \omega_1 \omega_2 d\varepsilon^p$$

where ε^p is the equivalent plastic strain,

$$\omega_1 = \left(\frac{1}{1 - \gamma \sigma_m}\right)^\alpha$$

is a triaxial stress weighting term and

$$\omega_2 = (2 - A_D)^\beta$$

is a asymmetric strain weighting term.

In the above σ_m is the mean stress and

$$A_D = \max\left(\frac{S_2}{S_3}, \frac{S_2}{S_1}\right)$$

Fracture is initiated when the accumulation of damage is

$$\frac{D}{D_c} > 1$$

where D_c is the a critical damage given by

$$D_c = D_0 (1 + b |\nabla D|^\lambda)$$

A fracture fraction

$$F = \frac{D - D_c}{D_s}$$

defines the degradations of the material by the Rc-Dc model.

The characteristic element length is used in the calculation of ∇D . Calculation of this factor is only done for element with smaller element length than this value.

***MAT_GENERAL_NONLINEAR_1DOF_DISCRETE_BEAM**

This is Material Type 121. This is a very general spring and damper model. This beam is based on the MAT_SPRING_GENERAL_NONLINEAR option and is a one-dimensional version of the 6DOF_DISCRETE_BEAM above. The forces generated by this model act along a line between the two connected nodal points. Additional unloading options have been included.

Card 1	1	2	3	4	5	6	7	8
Variable	MID	RO	K	IUNLD	OFFSET	DAMPF		
Type	A8	F	F	I	F	F		

Card 2	1	2	3	4	5	6	7	8
Variable	LCIDT	LCIDTU	LCIDTD	LCIDTE				
Type	I	I	I	I				

Card 3	1	2	3	4	5	6	7	8
Variable	UTFAIL	UCFAIL	IU					
Type	F	F	F					

VARIABLE	DESCRIPTION
MID	Material identification. A unique number or label not exceeding 8 characters must be specified.
RO	Mass density, see also volume in *SECTION_BEAM definition.
K	Translational stiffness for unloading option 2.0.

VARIABLE	DESCRIPTION
IUNLD	<p>Unloading option (Also see Figure 2-60):</p> <p>EQ.0.0: Loading and unloading follow loading curve</p> <p>EQ.1.0: Loading follows loading curve, unloading follows unloading curve. The unloading curve ID if undefined is taken as the loading curve.</p> <p>EQ.2.0: Loading follows loading curve, unloading follows unloading stiffness, K, to the unloading curve. The loading and unloading curves may only intersect at the origin of the axes.</p> <p>EQ.3.0: Quadratic unloading from peak displacement value to a permanent offset.</p>
OFFSET	<p>Offset to determine permanent set upon unloading if the IUNLD = 3.0. The permanent sets in compression and tension are equal to the product of this offset value and the maximum compressive and tensile displacements, respectively.</p>
DAMPF	<p>Damping factor for stability. Values in the neighborhood of unity are recommended. This damping factor is properly scaled to eliminate time step size dependency. Also, it is active if and only if the local stiffness is defined.</p>
LCIDT	<p>Load curve ID defining translational force resultant along the axis versus relative translational displacement. If zero, no stiffness related forces are generated for this degree of freedom. The loading curves must be defined from the most negative displacement to the most positive displacement. The force does not need to increase monotonically for the loading curve. The curves are extrapolated when the displacement range falls outside the curve definition.</p>
LCIDTU	<p>Load curve ID defining translational force resultant along the axis versus relative translational displacement during unloading. The force values defined by this curve must increase monotonically from the most negative displacement to the most positive displacement. For IUNLD = 1.0, the slope of this curve must equal or exceed the loading curve for stability reasons. This is not the case for IUNLD = 2.0. For loading and unloading to follow the same path simply set LCIDTU = LCIDT.</p>
LCIDTD	<p>Load curve ID defining translational damping force resultant along the axis versus relative translational velocity.</p>

VARIABLE	DESCRIPTION
LCIDTE	Load curve ID defining translational damping force scale factor versus relative displacement along the axis.
UTFAIL	Optional, translational displacement at failure in tension. If zero, failure in tension is not considered.
UCFAIL	Optional, translational displacement at failure in compression. If zero, failure in compression is not considered.
IU	Initial translational displacement along axis.

***MAT_HILL_3R**

This is Material Type 122. This is Hill's 1948 planar anisotropic material model with 3 R values.

Card 1	1	2	3	4	5	6	7	8
Variable	MID	R0	E	PR	HR	P1	P2	
Type	A8	F	F	F	F	F	F	

Card 2	1	2	3	4	5	6	7	8
Variable	R00	R45	R90	LCID	E0			
Type	F	F	F	F	F			

Card 3	1	2	3	4	5	6	7	8
Variable	AOPT							
Type	F							

Card 4	1	2	3	4	5	6	7	8
Variable				A1	A2	A3		
Type				F	F	F		

Card 5	1	2	3	4	5	6	7	8
Variable	V1	V2	V3	D1	D2	D3	BETA	
Type	F	F	F	F	F	F	F	

VARIABLE	DESCRIPTION
MID	Material identification. A unique number or label not exceeding 8 characters must be specified.
RO	Mass density.
E	Young's modulus, E
PR	Poisson's ratio, ν
HR	Hardening rule: EQ.1.0: linear (default), EQ.2.0: exponential. EQ.3.0: load curve
P1	Material parameter: HR.EQ.1.0: Tangent modulus, HR.EQ.2.0: k, strength coefficient for exponential hardening
P2	Material parameter: HR.EQ.1.0: Yield stress HR.EQ.2.0: n, exponent
R00	R00, Lankford parameter determined from experiments
R45	R45, Lankford parameter determined from experiments
R90	R90, Lankford parameter determined from experiments
LCID	load curve ID for the load curve hardening rule
E0	ϵ_0 for determining initial yield stress for exponential hardening. (Default = 0.0)

VARIABLE	DESCRIPTION
AOPT	<p>Material axes option (see MAT_OPTION TROPIC_ELASTIC for a more complete description):</p> <p>EQ.0.0: locally orthotropic with material axes determined by element nodes 1, 2, and 4, as with *DEFINE_COORDINATE_NODES, and then rotated about the shell element normal by an angle BETA.</p> <p>EQ.2.0: globally orthotropic with material axes determined by vectors defined below, as with *DEFINE_COORDINATE_VECTOR.</p> <p>EQ.3.0: locally orthotropic material axes determined by rotating the material axes about the element normal by an angle, BETA, from a line in the plane of the element defined by the cross product of the vector v with the element normal.</p> <p>LT.0.0: the absolute value of AOPT is a coordinate system ID number (CID on *DEFINE_COORDINATE_NODES, *DEFINE_COORDINATE_SYSTEM or *DEFINE_COORDINATE_VECTOR). Available in R3 version of 971 and later.</p>
XP YP ZP	Coordinates of point p for AOPT = 1 .
A1 A2 A3	Components of vector a for AOPT = 2 .
V1 V2 V3	Components of vector v for AOPT = 3 .
D1 D2 D3	Components of vector d for AOPT = 2 .
BETA	Material angle in degrees for AOPT = 0 and 3 , may be overridden on the element card, see *ELEMENT_SHELL_BETA .

***MAT_MODIFIED_PIECEWISE_LINEAR_PLASTICITY_{OPTION}**

This is Material Type 123. An elasto-plastic material with an arbitrary stress versus strain curve and arbitrary strain rate dependency can be defined. This model is available for shell and solid elements. Another model, MAT_PIECEWISE_LINEAR_PLASTICITY, is similar but lacks the enhanced failure criteria. Failure is based on effective plastic strain, plastic thinning, the major principal in plane strain component, or a minimum time step size. See the discussion under the model description for MAT_PIECEWISE_LINEAR_PLASTICITY if more information is desired.

Available options include:

<BLANK>

RATE

RTCL

The "RATE" option is used to account for rate dependence of plastic thinning failure. The "RTCL" option is used to activate RTCL damage. One additional card is needed with either option.

Card 1	1	2	3	4	5	6	7	8
Variable	MID	R0	E	PR	SIGY	ETAN	FAIL	TDEL
Type	A8	F	F	F	F	F	F	F
Default	none	none	none	none	none	0.0	10.E+20	0

Card 2	1	2	3	4	5	6	7	8
Variable	C	P	LCSS	LCSR	VP	EPSTHIN	EPSMAJ	NUMINT
Type	F	F	F	F	F	F	F	F
Default	0	0	0	0	0	0	0	0

MAT_123**MAT_MODIFIED_PIECEWISE_LINEAR_PLASTICITY**

Card 3	1	2	3	4	5	6	7	8
Variable	EPS1	EPS2	EPS3	EPS4	EPS5	EPS6	EPS7	EPS8
Type	F	F	F	F	F	F	F	F
Default	0	0	0	0	0	0	0	0

Card 4	1	2	3	4	5	6	7	8
Variable	ES1	ES2	ES3	ES4	ES5	ES6	ES7	ES8
Type	F	F	F	F	F	F	F	F
Default	0	0	0	0	0	0	0	0

Card 5 is required if and only if either the RATE or RTCL option is active.

Card 5	1	2	3	4	5	6	7	8
Variable	LCTSRF	EPS0	TRIAX					
Type	I	F	F					
Default	0	0	0					

VARIABLE**DESCRIPTION**

MID	Material identification. A unique number or label not exceeding 8 characters must be specified.
RO	Mass density.
E	Young's modulus.
PR	Poisson's ratio.
SIGY	Yield stress.

VARIABLE	DESCRIPTION
ETAN	Tangent modulus, ignored if (LCSS.GT.0) is defined.
FAIL	Failure flag. LT.0.0: User defined failure subroutine, matusr_24 in dyn21.F, is called to determine failure EQ.0.0: Failure is not considered. This option is recommended if failure is not of interest since many calculations will be saved. GT.0.0: Plastic strain to failure. When the plastic strain reaches this value, the element is deleted from the calculation.
TDEL	Minimum time step size for automatic element deletion.
C	Strain rate parameter, C, see formula below.
P	Strain rate parameter, P, see formula below.
LCSS	Load curve ID or Table ID. Load curve ID defining effective stress versus effective plastic strain. If defined EPS1 - EPS8 and ES1 - ES8 are ignored. The table ID defines for each strain rate value a load curve ID giving the stress versus effective plastic strain for that rate, See Figure 2-12 . The stress versus effective plastic strain curve for the lowest value of strain rate is used if the strain rate falls below the minimum value. Likewise, the stress versus effective plastic strain curve for the highest value of strain rate is used if the strain rate exceeds the maximum value. The strain rate parameters: C and P, the curve ID, LCSR, EPS1-EPS8, and ES1-ES8 are ignored if a Table ID is defined. NOTE: The strain rate values defined in the table may be given as the natural logarithm of the strain rate. If the <i>first</i> stress-strain curve in the table corresponds to a negative strain rate, LS-DYNA assumes that the natural logarithm of the strain rate value is used. Since the tables are internally discretized to equally space the points, natural logarithms are necessary, for example, if the curves correspond to rates from 10.e-04 to 10.e+04. Computing the natural logarithm of the strain rate does slow the stress update down significantly on some computers.
LCSR	Load curve ID defining strain rate scaling effect on yield stress.
VP	Formulation for rate effects: EQ.0.0: Scale yield stress (default), EQ.1.0: Viscoplastic formulation (recommended).

VARIABLE	DESCRIPTION
EPSTHIN	Thinning strain at failure. This number should be given as a positive number.
EPSMAJ	Major in plane strain at failure. LT.0: EPSMAJ = EPSMAJ and filtering is activated. The last twelve values of the major strain is stored at each integration point and the average value is used to determine failure.
NUMINT	Number of integration points which must fail before the element is deleted. (If zero, all points must fail.) For fully integrated shell formulations, each of the $4 \times \text{NIP}$ integration points are counted individually in determining a total for failed integration points. NIP is the number of through-thickness integration points. As NUMINT approaches the total number of integration points (NIP for under integrated shells, $4 \times \text{NIP}$ for fully integrated shells), the chance of instability increases. LT.0.0: NUMINT is percentage of integration points/layers which must fail before shell element fails. For fully integrated shells, a methodology is used where a layer fails if one integration point fails and then the given percentage of layers must fail before the element fails. Only available for shells.
EPS1 - EPS8	Effective plastic strain values (optional if SIGY is defined). At least 2 points should be defined. The first point must be zero corresponding to the initial yield stress. WARNING: If the first point is non-zero the yield stress is extrapolated to determine the initial yield. If this option is used SIGY and ETAN are ignored and may be input as zero.
ES1 - ES8	Corresponding yield stress values to EPS1 - EPS8.
LCTSRF	Load curve that defines the thinning strain at failure as a function of the plastic strain rate.
EPS0	EPS0 parameter for RTCL damage. EQ.0.0: (default) RTCL damage is inactive. GT.0.0: RTCL damage is active

VARIABLE	DESCRIPTION
TRIAX	RTCL damage triaxiality limit. EQ.0.0: (default) No limit. GT.0.0: Damage does not accumulate when triaxiality exceeds TRIAX.

Remarks:

Optional RTCL damage is used to fail elements when the damage function exceeds 1.0. During each solution cycle, if the plastic strain increment is greater than zero, an increment of RTCL damage is calculated by

$$\Delta f_{\text{damage}} = \frac{1}{\varepsilon_0} f\left(\frac{\sigma_H}{\bar{\sigma}}\right)_{\text{RTCL}} d\bar{\varepsilon}^p$$

where

$$f\left(\frac{\sigma_H}{\bar{\sigma}}\right)_{\text{RTCL}} = \begin{cases} 0 & \text{for } \frac{\sigma_H}{\bar{\sigma}} \leq -\frac{1}{3} \\ 2 \frac{1 + \frac{\sigma_H}{\bar{\sigma}} \sqrt{12 - 27\left(\frac{\sigma_H}{\bar{\sigma}}\right)^2}}{3 \frac{\sigma_H}{\bar{\sigma}} + \sqrt{12 - 27\left(\frac{\sigma_H}{\bar{\sigma}}\right)^2}} & \text{for } -\frac{1}{3} < \frac{\sigma_H}{\bar{\sigma}} < \frac{1}{3} \\ \frac{1}{1.65} \exp\left(\frac{3\sigma_H}{2\bar{\sigma}}\right) & \text{for } \frac{\sigma_H}{\bar{\sigma}} \geq \frac{1}{3} \end{cases}$$

ε_0 = uniaxial fracture strain / critical damage value

σ_H = hydrostatic stress

$\bar{\sigma}$ = effective stress

$d\bar{\varepsilon}^p$ = effective plastic strain increment

The increments are summed through time and the element is deleted when $f_{\text{damage}} \geq 1.0$. For $0.0 < f_{\text{damage}} < 1.0$, the element strength will not be degraded.

The value of f_{damage} is stored as the 9th extra history variable and can be fringe plotted from d3plot files if the number of extra history variables requested is ≥ 9 on *DATABASE_EXTENT_BINARY. If however NUMINT < 0, then the value of f_{damage} is stored as the 10th extra history variable.

The optional TRIAX parameter can be used to prevent excessive RTCL damage growth and element erosion for badly shaped elements that might show unrealistic high values for the triaxiality.

***MAT_PLASTICITY_COMPRESSION_TENSION**

This is Material Type 124. An isotropic elastic-plastic material where unique yield stress versus plastic strain curves can be defined for compression and tension. Also, failure can occur based on a plastic strain or a minimum time step size. Rate effects on the yield stress are modeled either by using the Cowper-Symonds strain rate model or by using two load curves that scale the yield stress values in compression and tension, respectively. Material rate effects, which are independent of the plasticity model, are based on a 6-term Prony series Maxwell mode that generates an additional stress tensor. The viscous stress tensor is superimposed on the stress tensor generated by the plasticity.

Card 1	1	2	3	4	5	6	7	8
Variable	MID	RO	E	PR	C	P	FAIL	TDEL
Type	A8	F	F	F	F	F	F	F
Default	none	none	none	none	0	0	10.E+20	0

Card 2	1	2	3	4	5	6	7	8
Variable	LCIDC	LCIDT	LCSRC	LCSRT	SRFLAG	LCFAIL	EC	RPCT
Type	I	I	I	I	F	I	F	F
Default	0	0	0	0	0	0	none	0

Card 3	1	2	3	4	5	6	7	8
Variable	PC	PT	PCUTC	PCUTT	PCUTF			
Type	F	F	F	F	F			
Default	0	0	0	0	0			

Card 4	1	2	3	4	5	6	7	8
Variable	K							
Type	F							

Viscoelastic Constant Cards. Up to 6 cards may be input. A keyword card (with a "*" in column 1) terminates this input if less than 6 cards are used.

Cards opt.	1	2	3	4	5	6	7	8
Variable	GI	BETAI						
Type	F	F						

<u>VARIABLE</u>	<u>DESCRIPTION</u>
MID	Material identification. A unique number or label not exceeding 8 characters must be specified.
RO	Mass density.
E	Young's modulus.
PR	Poisson's ratio.
C	Strain rate parameter, C, see formula below.
P	Strain rate parameter, P, see formula below.
FAIL	Failure flag. LT.0.0: User defined failure subroutine, matusr_24 in dyn21.F, is called to determine failure EQ.0.0: Failure is not considered. This option is recommended if failure is not of interest since many calculations will be saved. GT.0.0: Plastic strain to failure. When the plastic strain reaches this value, the element is deleted from the calculation.
TDEL	Minimum time step size for automatic element deletion.

VARIABLE	DESCRIPTION
LCIDC	Load curve ID defining yield stress versus effective plastic strain in compression.
LCIDT	Load curve ID defining yield stress versus effective plastic strain in tension.
LCSRC	Optional load curve ID defining strain rate scaling effect on yield stress when the material is in compression.
LCSRT	Optional load curve ID defining strain rate scaling effect on yield stress when the material is in tension.
SRFLAG	Formulation for rate effects: EQ.0.0: Total strain rate, EQ.1.0: Deviatoric strain rate. EQ.2.0: Plastic strain rate (viscoplastic).
LCFAIL	Load curve ID defining failure strain versus strain rate.
EC	Optional Young's modulus for compression, > 0 .
RPCT	Ratio of PC and PT, used to define mean stress at which Young's modulus is E or EC. Young's modulus is E when mean stress $> RPCT \times PT$, and EC when mean stress $< -RPCT \times PC$. If the mean stress falls between $-RPCT \times PC$ and $RPCT \times PT$, a linearly interpolated value is used.
PC	Compressive mean stress (pressure) at which the yield stress follows load curve ID, LCIDC. If the pressure falls between PC and PT a weighted average of the two load curves is used.
PT	Tensile mean stress at which the yield stress follows load curve ID, LCIDT.
PCUTC	Pressure cut-off in compression (PCUTC must be greater than or equal to zero). This option applies only to solid elements. When the pressure cut-off is reached the deviatoric stress tensor is set to zero and the pressure remains at its compressive value. Like the yield stress, PCUTC is scaled to account for rate effects.

VARIABLE	DESCRIPTION
PCUTT	Pressure cut-off in tension (PCUTT must be less than or equal to zero). This option applies only to solid elements. When the pressure cut-off is reached the deviatoric stress tensor and tensile pressure is set to zero. Like the yield stress, PCUTT is scaled to account for rate effects.
PCUTF	Pressure cut-off flag activation. EQ.0.0: Inactive, EQ.1.0: Active.
K	Optional bulk modulus for the viscoelastic material. If nonzero a Kelvin type behavior will be obtained. Generally, K is set to zero.
GI	Optional shear relaxation modulus for the ith term
BETAI	Optional shear decay constant for the ith term

Remarks:

The stress strain behavior follows a different curve in compression than it does in tension. Tension is determined by the sign of the mean stress where a positive mean stress (i.e., a negative pressure) is indicative of tension. Two curves must be defined giving the yield stress versus effective plastic strain for both the tension and compression regimes.

Mean stress is an invariant which can be expressed as $(\sigma_x + \sigma_y + \sigma_z)/3$. PC and PT define a range of mean stress values within which interpolation is done between the tensile yield surface and compressive yield surface. PC and PT are not true material properties but are just a numerical convenience so that the transition from one yield surface to the other is not abrupt as the sign of the mean stress changes. Both PC and PT are input as positive values as it is implied that PC is a compressive mean stress value and PT is tensile mean stress value.

Strain rate may be accounted for using the Cowper and Symonds model which scales the yield stress with the factor:

$$1 + \left(\frac{\dot{\epsilon}}{C}\right)^{1/p}$$

where $\dot{\epsilon}$ is the strain rate,

$$\dot{\epsilon} = \sqrt{\dot{\epsilon}_{ij}\dot{\epsilon}_{ij}}$$

***MAT_KINEMATIC_HARDENING_TRANSVERSELY_ANISOTROPIC**

This is Material Type 125. This material model combines Yoshida's non-linear kinematic hardening rule with material type 37. Yoshida's theory uses two surfaces to describe the hardening rule: the yield surface and the bounding surface. In the forming process, the yield surface does not change in size, but its center translates with deformation; the bounding surface changes both in size and location. This model allows the change of Young's modulus as a function of effective plastic strain as proposed by Yoshida [2002]. This material type is available for shells, thick shells and solid elements.

Card 1	1	2	3	4	5	6	7	8
Variable	MID	R0	E	PR	R	HLCID	OPT	
Type	A8	F	F	F	F	I	I	
Default	none	none	none	none	none	none	none	

Card 2	1	2	3	4	5	6	7	8
Variable	CB	Y	SC1	K	RSAT	SB	H	SC2
Type	F	F	F	F	F	F	F	F
Default	none	none	none	none	none	none	none	none

Card 3	1	2	3	4	5	6	7	8
Variable	EA	COE	IOPT	C1	C2			
Type	F	F	I	F	F			
Default	none	none	0	none	none			

VARIABLE**DESCRIPTION**

MID

Material identification. A unique number or label not exceeding 8 characters must be specified.

VARIABLE	DESCRIPTION
RO	Mass density.
E	Young's Modulus
PR	Poisson's ratio
R	Anisotropic hardening parameter
HLCID	Load curve ID in keyword *DEFINE_CURVE, where true strain and true stress relationship is characterized. This curve is used in conjunction with variable OPT, and not to be referenced or used in other keywords.
OPT	Error calculation flag. When OPT = 2, LS-DYNA will perform error calculation on the true stress-strain curve from uniaxial tension, specified by HLCID. This variable must be set to a value of '2' if HLCID is specified and stress-strain curve is used.
CB	The uppercase B defined in the following equations.
Y	Hardening parameter as defined in the following equations.
SC1	The lowercase c defined in the following equations, and c1, as in remarks.
K	Hardening parameter as defined in the following equations.
RSAT	Hardening parameter as defined in the following equations.
SB	The lowercase b as defined in the following equations.
H	Anisotropic parameter associated with work-hardening stagnation.
SC2	The lowercase c defined in the following equations, and c2 as in remarks. If SC2 = 0.0 or left blank, then it turns into the basic model.
EA	Variable controlling the change of Young's modulus, E^A in the following equations.
COE	Variable controlling the change of Young's modulus, ζ in the following equations.
IOPT	Modified kinematic hardening rule flag: EQ.0: Original Yoshida formulation, EQ.1: Modified formulation. Define C1, C2 below.

VARIABLE	DESCRIPTION
C1, C2	Constants used to modify R : $R = \text{RSAT} \times [(C_1 + \bar{\epsilon}^p)^{c_2} - C_1^{c_2}]$

The Yoshida kinematic hardening model:

According to F. Yoshida and T. Uemori’s paper titled “A model of large-strain cyclic plasticity describing the Bauschinger effect and work hardening stagnation” in 2002 International Journal of Plasticity 18, 661-686, and referring to [Figure 2-61](#),

$$\alpha_* = \alpha - \beta$$

$$\alpha_* = c \left[\left(\frac{a}{Y} \right) (\sigma - \alpha) - \sqrt{\frac{a}{\alpha_*}} \alpha_* \right] \bar{\epsilon}^p$$

$$a = B + R - Y$$

The change of size and location for the bounding surface is defined as (see [Figure 2-62](#)),

$$\dot{R} = k(R_{\text{sat}} - R)\dot{\bar{\epsilon}}^p,$$

$$\dot{\beta}' = k\left(\frac{2}{3}bD - \beta'\right)\dot{\bar{\epsilon}}^p$$

$$\sigma_{\text{bound}} = B + R + \beta$$

In Yoshida’s model, there is work-hardening stagnation in the unloading process, and it is described as,

$$g_\sigma(\sigma', q', r') = \frac{3}{2}(\sigma' - q') : (\sigma' - q') - r^2$$

$$\dot{q}' = \mu(\beta' - q')$$

$$r = h\Gamma$$

$$\Gamma = \frac{3(\beta' - q') : \dot{\beta}'}{2r}$$

Change in Young’s modulus is defined as a function of effective strain,

$$E = E_0 - (E_0 - E_A)[1 - \exp(-\zeta\bar{\epsilon}^p)]$$

Strain hardening saturation:

Further improvements in the original Yoshida’s model, as described in a paper “*Determination of Nonlinear Isotropic/Kinematic Hardening Constitutive Parameter for AHSS using Tension and Compression Tests*”, by Ming F. Shi, Xinhai Zhu, Cedric Xia, Thomas Stoughton, in *NUMISHEET 2008 proceedings*, 137-142, 2008, included modifications to allow working hardening in large strain deformation region, avoiding the problem of earlier saturation, especially for Advanced High Strength Steel (AHSS). These types of steels exhibit continuous strain hardening behavior and a non-saturated isotropic hardening function. As described in the paper, the evolution equation for R (a part of the current radius of the bounding surface in deviatoric stress space), as is with the saturation type of isotropic hardening rule proposed in the original Yoshida model,

$$\dot{R} = m(R_{sat} - R)\dot{\epsilon}$$

is modified as,

$$R = RSAT \times [(C_1 + \bar{\epsilon}^p)^{c_2} - C_1^{c_2}]$$

For saturation type of isotropic hardening rule, set IOPT = 0, applicable to most of Aluminum sheet materials. In addition, the paper provides detailed variables used for this material model for DDQ, HSLA, DP600, DP780 and DP980 materials. Since the symbols used in the paper are different from what are used here, the following table provides a reference between symbols used in the paper and variables here in this keyword:

B	Y	C	m	K	b	h	e ⁰	N
CB	Y	SC	K	Rsat	SB	H	C1	C2

Using the modified formulation and the material properties provided by the paper, the predicted and tested results compared very well both in a full cycle tension and compression test and in a pre-strained tension and compression test, according to the paper.

Application results:

Application of the modified Yoshida’s hardening rule in the metal forming industry has shown significant advantage in springback prediction accuracy, especially for AHSS type of sheet materials. As shown in [Figure 2-63](#) (left), predicted springback shape of an automotive shotgun (also called: upper load path/beam) using *MAT_125 is compared with experimental measurements on a DP780 material. Prediction accuracy achieved over 92% with *MAT_125 while about 61% correlation is found with *MAT_037 ([Figure 2-63](#) right), a remarkable improvement.

In another example, NUMISHEET 2011 BM4 is used to demonstrate the application of the Young’s modulus variations as a function of effective strain in prediction of springback. The sheet blank is a DP780 material with an initial thickness of 1.4mm. The simulation process is shown ([Figure 2-64](#)) as pre-straining (to 8%), springback, trimming, forming and

springback. Young's modulus variations with effective strains are accounted for by curve fitting the provided experimental data to obtain the variables EA and COE, [Figure 2-65](#). Referring to [Figures 2-66](#) and [2-67](#), final springback shapes of the cross sectional view are compared with measurement provided, along with benchmark results from software X and Y. In addition, springback with no pre-straining is also conducted and correlated, shown in the same figures. Furthermore, hysteretic plasticity with a full cycle tension and compression simulation is done on one single shell element and the result is superimposed with experimental data, in [Figure 2-68](#).

To improve convergence and for a faster simulation time, it is recommended that *CONTROL_IMPLICIT_FORMING type '1' be used when conducting a springback simulation.

About SC1 and SC2:

In F. Yoshida and T. Uemori's 2002 paper, the effect of variables SC1 and SC2 were discussed. According to the paper, variables SC1 and SC2 are used to describe the forward and reverse deformations of the cyclic plasticity curve, respectively. It allows for a more rapid change of work hardening rate in the vicinity of the initial yielding (~0.5% equivalent plastic strain), in the form of the following equations:

$$SC = SC_1 \text{ when } \text{Max}(\bar{\alpha}_*) < B - Y, \quad (1a)$$

$$SC = SC_2, (C_1 > C_2), \text{ otherwise.} \quad (1b)$$

where $\text{Max}(\bar{\alpha}_*)$ is the maximum value of $\bar{\alpha}_*$, and,

$$\bar{\alpha}_* = \sqrt{\frac{3}{2} \alpha_* : \alpha_*}$$

As shown in [Figure 2-69](#), the effect of a curve fitting is shown for a high strength steel (SPFC) using both SC1 and SC2, and in comparison with a fitting using only SC1, from Yoshida & Uemori's original paper: In addition, In [Figure 2-70](#), a much better fitting is demonstrated with SC1 and SC2 than with SC1 only for a DP980 material.

Revision information:

The variables HLCID, OPT, IOPT, C1, and C2 are available in LS-DYNA Revision 46217 or later releases. The variables SC1 and SC2 are available in LS-DYNA Revision 74884 and later releases.

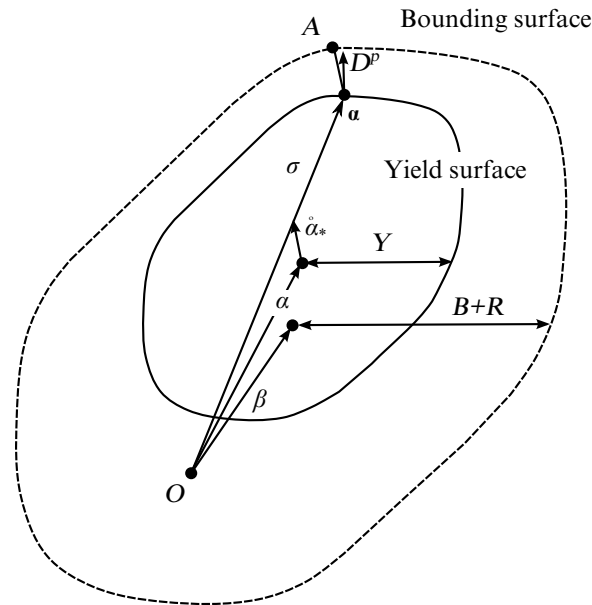

Figure 2-61. Schematic illustration of the two-surface model is the original center of the yield surface, α_* is the current center for the yield surface; α is the center of the bounding surface. β represents the relative position of the centers of the two surfaces. Y is the size of the yield surface and is constant throughout the deformation process. $B+R$ represents the size of the bounding surface, with R being associated with isotropic hardening. *Reproduced from the original Yoshida and Uemori's paper.*

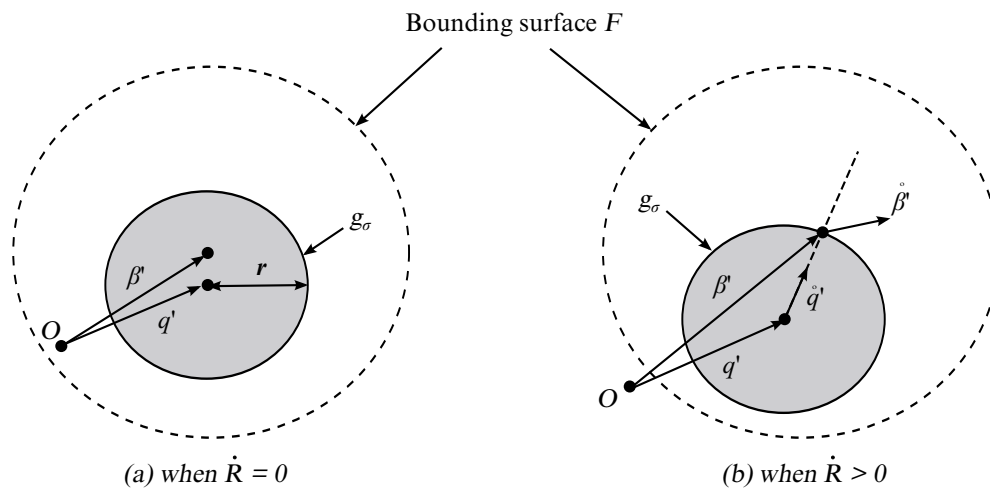

Figure 2-62. Change in bounding surface (*reproduced from the original Yoshida and Uemori's paper*).

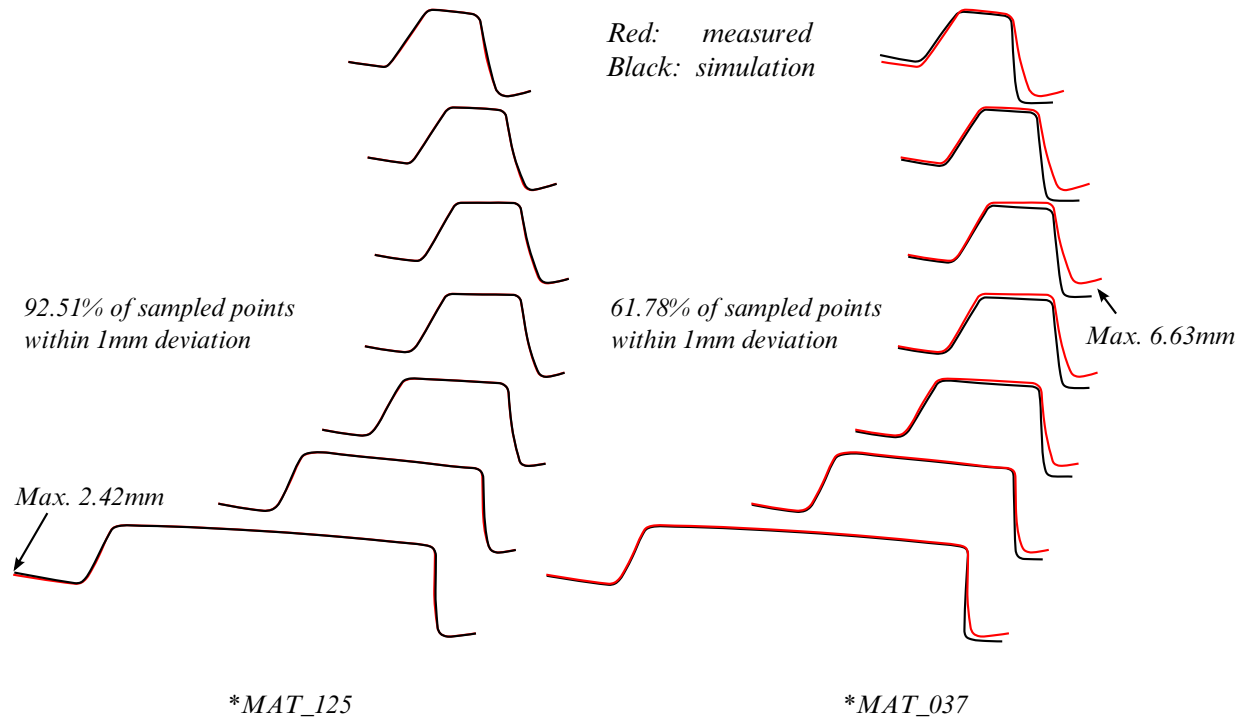

Figure 2-63. Comparison of springback prediction on the A/S P load beam (reproduced from an original color contour map courtesy of Chrysler LLC and United States Steel Corporation).

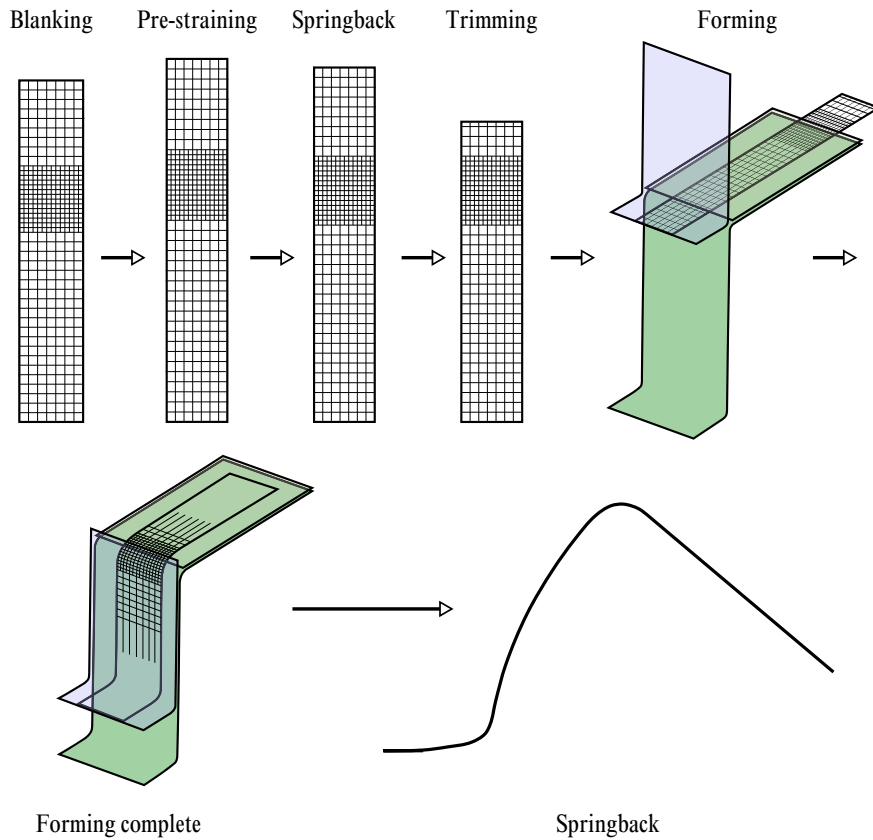

Figure 2-64. NUMISHEET 2011 Benchmark #4 simulation procedure.

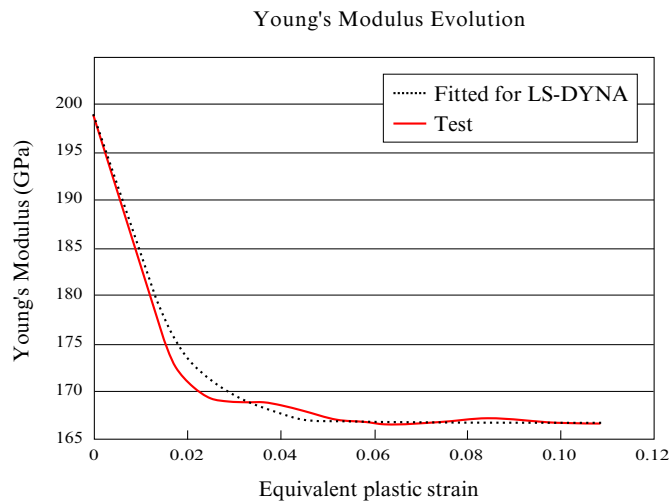

Figure 2-65. Curve fitting with coefficients: EA = 1.668E+05; COE = 95.0.

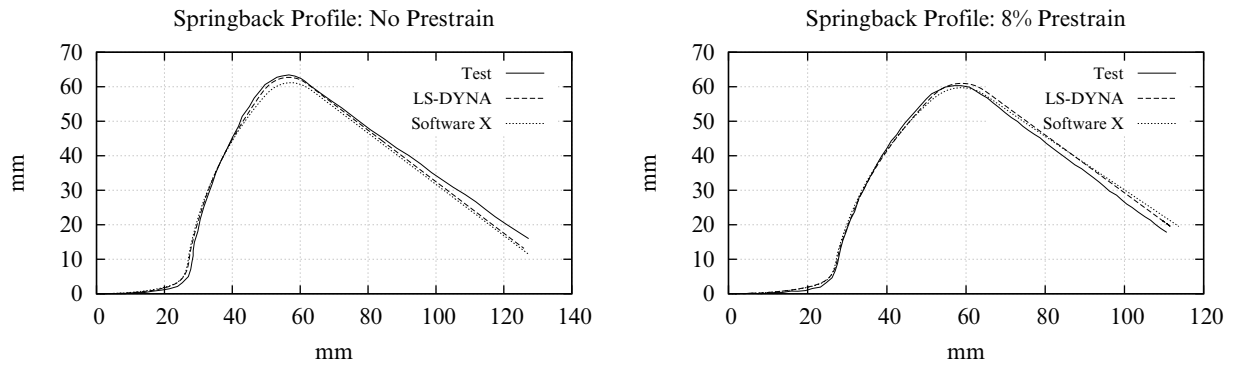

Figure 2-66. Comparison of springback profile with software X: 0% (left) and 8% prestrain (right)

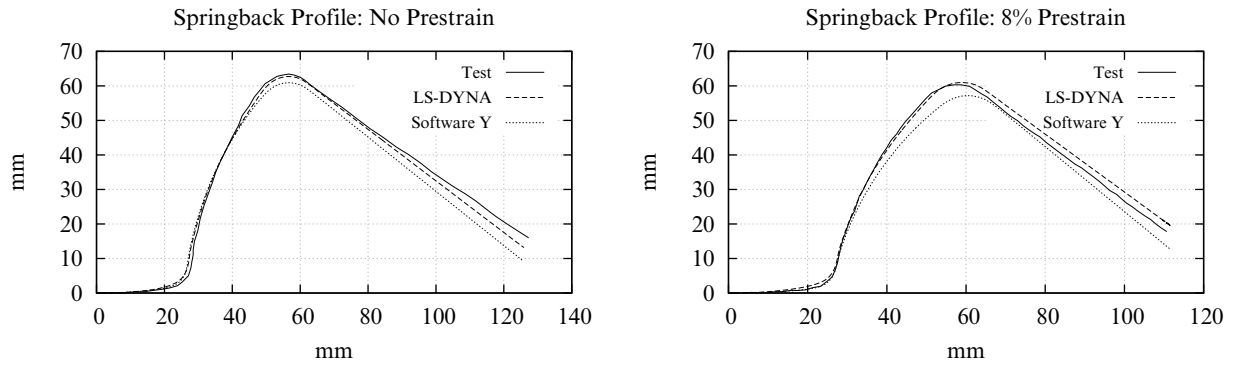

Figure 2-67. Comparison of springback profile with software Y: 0% (left) and 8% prestrain(right)

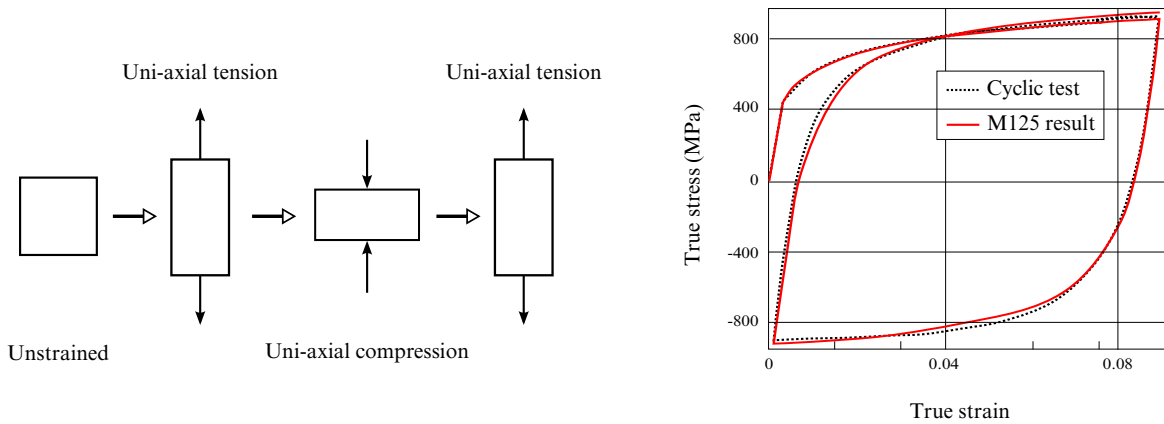

Figure 2-68. Cyclic plasticity verification on one element.

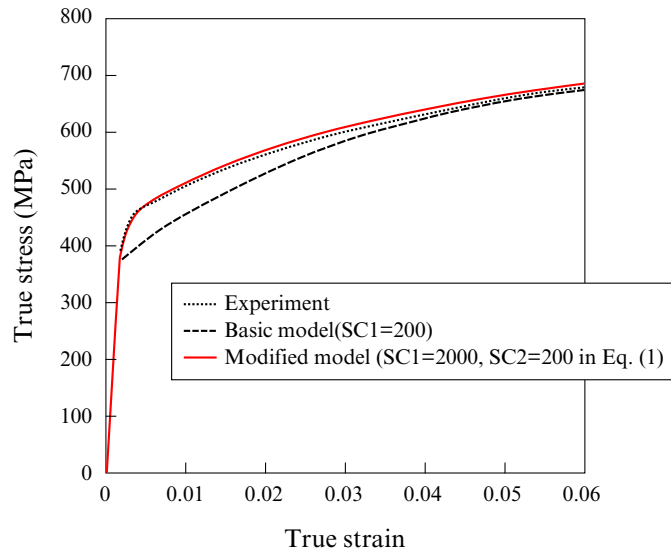

Figure 2-69. Effect of SC1 and SC2 (reproduced from the original Yoshida & Uemori's paper).

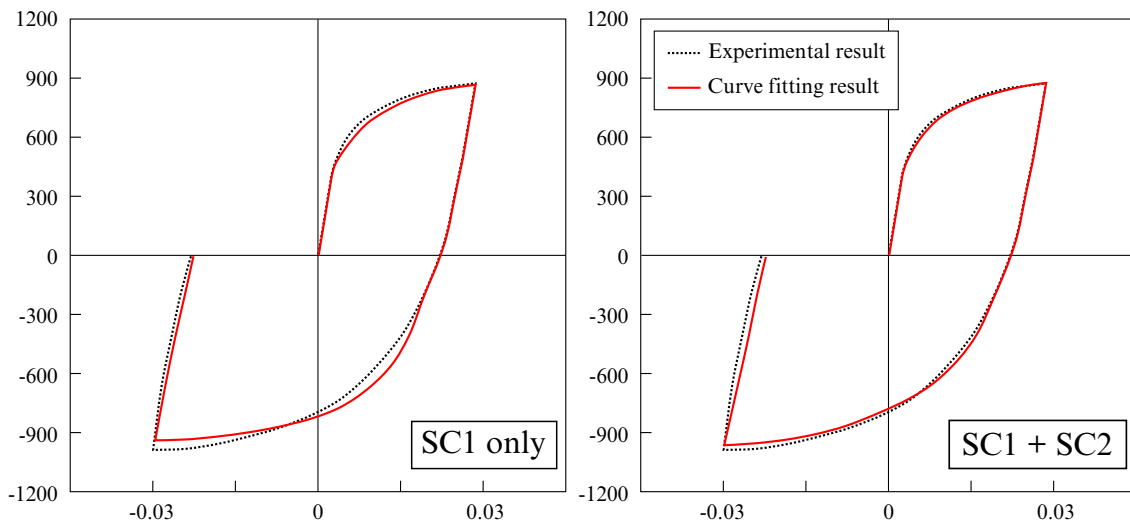

Figure 2-70. Material curve fitting comparison (reproduced from an original color slide courtesy of CYBERNET SYSTEMS CO., LTD.).

***MAT_MODIFIED_HONEYCOMB**

This is Material Type 126. The major use of this material model is for aluminum honeycomb crushable foam materials with anisotropic behavior. Three yield surfaces are available. In the first, nonlinear elastoplastic material behavior can be defined separately for all normal and shear stresses, which are considered to be fully uncoupled. In the second, a yield surface is defined that considers the effects of off-axis loading. The second yield surface is transversely isotropic. A drawback of this second yield surface is that the material can collapse in a shear mode due to low shear resistance. There was no obvious way of increasing the shear resistance without changing the behavior in purely uniaxial compression. Therefore, in the third option, the model has been modified so that the user can prescribe the shear and hydrostatic resistance in the material without affecting the uniaxial behavior. The choice of the second yield surface is flagged by the sign of the first load curve ID, LCA. The third yield surface is flagged by the sign of ECCU, which becomes the initial stress yield limit in simple shear. A description is given below.

The development of the second and third yield surfaces are based on experimental test results of aluminum honeycomb specimens at Toyota Motor Corporation.

The default element for this material is solid type 0, a nonlinear spring type brick element. The recommended hourglass control is the type 2 viscous formulation for one point integrated solid elements. The stiffness form of the hourglass control when used with this constitutive model can lead to nonphysical results since strain localization in the shear modes can be inhibited.

Card 1	1	2	3	4	5	6	7	8
Variable	MID	R0	E	PR	SIGY	VF	MU	BULK
Type	A8	F	F	F	F	F	F	F
Default	none	none	none	none	none	none	.05	0.0

Card 2	1	2	3	4	5	6	7	8
Variable	LCA	LCB	LCC	LCS	LCAB	LCBC	LCCA	LCSR
Type	F	F	F	F	F	F	F	F
Default	none	LCA	LCA	LCA	LCS	LCS	LCS	optional

Card 3	1	2	3	4	5	6	7	8
Variable	EAAU	EBBU	ECCU	GABU	GBCU	GCAU	AOPT	MACF
Type	F	F	F	F	F	F		I

Card 4	1	2	3	4	5	6	7	8
Variable	XP	YP	ZP	A1	A2	A3		
Type	F	F	F	F	F	F		

Card 5	1	2	3	4	5	6	7	8
Variable	D1	D2	D3	TSEF	SSEF	VREF	TREF	SHDFLG
Type	F	F	F	F	F	F	F	F

Additional card for AOPT = 3 or AOPT = 4.

Card 6	1	2	3	4	5	6	7	8
Variable	V1	V2	V3					
Type	F	F	F					

Additional card for LCSR = -1.0

Card 7	1	2	3	4	5	6	7	8
Variable	LCSRA	LCSRB	LCSRC	LCSRAB	LCSRBC	LCSCA		
Type	F	F	F	F	F	F		

VARIABLE**DESCRIPTION**

MID	Material identification. A unique number or label not exceeding 8 characters must be specified.
RO	Mass density.
E	Young's modulus for compacted honeycomb material.
PR	Poisson's ratio for compacted honeycomb material.
SIGY	Yield stress for fully compacted honeycomb.
VF	Relative volume at which the honeycomb is fully compacted. This parameter is ignored for corotational solid elements, types 0 and 9.
MU	μ , material viscosity coefficient. (default=.05) Recommended.
BULK	Bulk viscosity flag: EQ.0.0: bulk viscosity is not used. This is recommended. EQ.1.0: bulk viscosity is active and $\mu = 0$. This will give results identical to previous versions of LS-DYNA.
LCA	Load curve ID, see *DEFINE_CURVE: LCA.LT.0: Yield stress as a function of the angle off the material axis in degrees. LCA.GT.0: sigma-aa versus normal strain component aa. For the corotational solid elements, types 0 and 9, engineering strain is expected, but for all other solid element formulations a logarithmic strain is expected. See Remarks.

VARIABLE	DESCRIPTION
LCB	<p>Load curve ID, see *DEFINE_CURVE:</p> <p>LCA.LT.0: strong axis hardening stress as a function of the volumetric strain.</p> <p>LCA.GT.0: sigma-bb versus normal strain component bb. For the corotational solid elements, types 0 and 9, engineering strain is expected, but for all other solid element formulations a logarithmic strain is expected. Default LCB = LCA. See Remarks.</p>
LCC	<p>Load curve ID, see *DEFINE_CURVE:</p> <p>LCA.LT.0: weak axis hardening stress as a function of the volumetric strain.</p> <p>LCA.GT.0: sigma-cc versus normal strain component cc. For the corotational solid elements, types 0 and 9, engineering strain is expected, but for all other solid element formulations a logarithmic strain is expected. Default LCC = LCA. See Remarks.</p>
LCS	<p>Load curve ID, see *DEFINE_CURVE:</p> <p>LCA.LT.0: damage curve giving shear stress multiplier as a function of the shear strain component. This curve definition is optional and may be used if damage is desired. IF SHDFLG = 0 (the default), the damage value multiplies the stress every time step and the stress is updated incrementally. The damage curve should be set to unity until failure begins. After failure the value should drop to 0.999 or 0.99 or any number between zero and one depending on how many steps are needed to zero the stress. Alternatively, if SHDFLG = 1, the damage value is treated as a factor that scales the shear stress compared to the undamaged value.</p> <p>LCA.GT.0: shear stress versus shear strain. For the corotational solid elements, types 0 and 9, engineering strain is expected, but for all other solid element formulations a shear strain based on the deformed configuration is used. Default LCS = LCA. Each component of shear stress may have its own load curve. See Remarks.</p>

VARIABLE	DESCRIPTION
LCAB	<p>Load curve ID, see *DEFINE_CURVE. Default LCAB = LCS:</p> <p>LCA.LT.0: damage curve giving shear ab-stress multiplier as a function of the ab-shear strain component. This curve definition is optional and may be used if damage is desired. See LCS above.</p> <p>LCA.GT.0: sigma-ab versus shear strain-ab. For the corotational solid elements, types 0 and 9, engineering strain is expected, but for all other solid element formulations a shear strain based on the deformed configuration is used. See Remarks.</p>
LCBC	<p>Load curve ID, see *DEFINE_CURVE. Default LCBC = LCS:</p> <p>LCA.LT.0: damage curve giving bc-shear stress multiplier as a function of the ab-shear strain component. This curve definition is optional and may be used if damage is desired. See LCS above.</p> <p>LCA.GT.0: sigma-bc versus shear strain-bc. For the corotational solid elements, types 0 and 9, engineering strain is expected, but for all other solid element formulations a shear strain based on the deformed configuration is used. See Remarks.</p>
LCCA	<p>Load curve ID, see *DEFINE_CURVE. Default LCCA = LCS:</p> <p>LCA.LT.0: damage curve giving ca-shear stress multiplier as a function of the ca-shear strain component. This curve definition is optional and may be used if damage is desired. See LCS above.</p> <p>LCA.GT.0: sigma-ca versus shear strain-ca. For the corotational solid elements, types 0 and 9, engineering strain is expected, but for all other solid element formulations a shear strain based on the deformed configuration is used. See Remarks.</p>
LCSR	<p>Load curve ID, see *DEFINE_CURVE, for strain-rate effects defining the scale factor versus effective strain rate $\dot{\epsilon} = \sqrt{\frac{2}{3}(\dot{\epsilon}'_{ij}\dot{\epsilon}'_{ij})}$. This is optional. The curves defined above are scaled using this curve.</p>
EAAU	Elastic modulus E_{aaU} in uncompressed configuration.
EBBU	Elastic modulus E_{bbU} in uncompressed configuration.

VARIABLE	DESCRIPTION
ECCU	Elastic modulus E_{ccu} in uncompressed configuration. LT.0.0: σ_d^Y , $ ECCU $ initial stress limit (yield) in simple shear. Also, $LCA < 0$ to activate the transversely isotropic yield surface.
GABU	Shear modulus G_{abu} in uncompressed configuration.
GBCU	Shear modulus G_{bcu} in uncompressed configuration.
GCAU	Shear modulus G_{cau} in uncompressed configuration. ECCU.LT.0.0: σ_p^Y , GCAU initial stress limit (yield) in hydrostatic compression. Also, $LCA < 0$ to activate the transversely isotropic yield surface.

VARIABLE	DESCRIPTION
AOPT	<p>Material axes option (see MAT_OPTIONTROPIC_ELASTIC for a more complete description):</p> <p>EQ.0.0: locally orthotropic with material axes determined by element nodes 1, 2, and 4, as with *DEFINE_COORDINATE_NODES.</p> <p>EQ.1.0: locally orthotropic with material axes determined by a point in space and the global location of the element center; this is the a-direction.</p> <p>EQ.2.0: globally orthotropic with material axes determined by vectors defined below, as with *DEFINE_COORDINATE_VECTOR.</p> <p>EQ.3.0: locally orthotropic material axes determined by rotating the material axes about the element normal by an angle, BETA, from a line in the plane of the element defined by the cross product of the vector v with the element normal. The plane of a solid element is the midsurface between the inner surface and outer surface defined by the first four nodes and the last four nodes of the connectivity of the element, respectively.</p> <p>EQ.4.0: locally orthotropic in cylindrical coordinate system with the material axes determined by a vector v, and an originating point, p, which define the centerline axis. This option is for solid elements only.</p> <p>LT.0.0: the absolute value of AOPT is a coordinate system ID number (CID on *DEFINE_COORDINATE_NODES, *DEFINE_COORDINATE_SYSTEM or *DEFINE_COORDINATE_VECTOR).</p>
MACF	<p>Material axes change flag:</p> <p>EQ.1: No change, default,</p> <p>EQ.2: switch material axes a and b,</p> <p>EQ.3: switch material axes a and c,</p> <p>EQ.4: switch material axes b and c.</p>
XP YP ZP	Coordinates of point p for AOPT = 1 and 4.
A1 A2 A3	Components of vector a for AOPT = 2.
D1 D2 D3	Components of vector d for AOPT = 2.

VARIABLE	DESCRIPTION
V1 V2 V3	Define components of vector \mathbf{v} for AOPT = 3 and 4.
TSEF	Tensile strain at element failure (element will erode).
SSEF	Shear strain at element failure (element will erode).
VREF	This is an optional input parameter for solid elements types 1, 2, 3, 4, and 10. Relative volume at which the reference geometry is stored. At this time the element behaves like a nonlinear spring. The TREF, below, is reached first then VREF will have no effect.
TREF	This is an optional input parameter for solid elements types 1, 2, 3, 4, and 10. Element time step size at which the reference geometry is stored. When this time step size is reached the element behaves like a nonlinear spring. If VREF, above, is reached first then TREF will have no effect.
SHDFLG	Flag defining treatment of damage from curves LCS, LCAB, LCBC and LCCA (relevant only when LCA < 0): EQ.0.0: Damage reduces shear stress every time step, EQ.1.0: Damage = (shear stress)/(undamaged shear stress)
LCSRA	Optional load curve ID if LCSR = -1, see *DEFINE_CURVE, for strain rate effects defining the scale factor for the yield stress in the a -direction versus the <i>natural logarithm</i> of the absolute value of deviatoric strain rate in the a -direction. This curve is optional. The scale factor for the lowest value of strain rate defined by the curve is used if the strain rate is zero. The scale factor for the highest value of strain rate defined by the curve also defines the upper limit of the scale factor.
LCSRB	Optional load curve ID if LCSR = -1, see *DEFINE_CURVE, for strain rate effects defining the scale factor for the yield stress in the b -direction versus the <i>natural logarithm</i> of the absolute value of deviatoric strain
LCSRC	Similar definition as for LCSA and LCSB above.
LCSRAB	Similar definition as for LCSA and LCSB above.
LCSRBC	Similar definition as for LCSA and LCSB above.
LCSRCA	Similar definition as for LCSA and LCSB above.

Remarks:

For efficiency it is strongly recommended that the load curve ID's: LCA, LCB, LCC, LCS, LCAB, LCBC, and LCCA, contain exactly the same number of points with corresponding strain values on the abscissa. If this recommendation is followed the cost of the table lookup is insignificant. Conversely, the cost increases significantly if the abscissa strain values are not consistent between load curves.

For solid element formulations 1 and 2, the behavior before compaction is orthotropic where the components of the stress tensor are uncoupled, i.e., an a component of strain will generate resistance in the local *a*-direction with no coupling to the local *b* and *c* directions. The elastic moduli vary from their initial values to the fully compacted values linearly with the relative volume:

$$\begin{aligned} E_{aa} &= E_{aa0} + \beta(E - E_{aa0}) & G_{ab} &= G_{ab0} + \beta(G - G_{ab0}) \\ E_{bb} &= E_{bb0} + \beta(E - E_{bb0}) & G_{bc} &= G_{bc0} + \beta(G - G_{bc0}) \\ E_{cc} &= E_{cc0} + \beta(E - E_{cc0}) & G_{ca} &= G_{ca0} + \beta(G - G_{ca0}) \end{aligned}$$

where

$$\beta = \max \left[\min \left(\frac{1 - V}{1 - V_f}, 1 \right), 0 \right]$$

and *G* is the elastic shear modulus for the fully compacted honeycomb material

$$G = \frac{E}{2(1 + \nu)}$$

The relative volume, *V*, is defined as the ratio of the current volume over the initial volume, and typically, *V* = 1 at the beginning of a calculation.

For corotational solid elements, types 0 and 9, the components of the stress tensor remain uncoupled and the uncompressed elastic moduli are used, that is, the fully compacted elastic moduli are ignored.

The load curves define the magnitude of the stress as the material undergoes deformation. The first value in the curve should be less than or equal to zero corresponding to tension and increase to full compaction. **Care should be taken when defining the curves so the extrapolated values do not lead to negative yield stresses.**

At the beginning of the stress update we transform each element's stresses and strain rates into the local element coordinate system. For the uncompacted material, the trial stress components are updated using the elastic interpolated moduli according to:

$$\sigma_{aa}^{n+1\text{trial}} = \sigma_{aa}^n + E_{aa}\Delta\varepsilon_{aa}$$

$$\sigma_{ab}^{n+1\text{trial}} = \sigma_{ab}^n + 2G_{ab}\Delta\varepsilon_{ab}$$

$$\sigma_{cc}^{n+1\text{trial}} = \sigma_{cc}^n + E_{cc}\Delta\varepsilon_{cc}$$

$$\sigma_{bc}^{n+1\text{trial}} = \sigma_{bc}^n + 2G_{bc}\Delta\varepsilon_{bc}$$

$$\sigma_{bb}^{n+1\text{trial}} = \sigma_{bb}^n + E_{bb}\Delta\varepsilon_{bb}$$

$$\sigma_{ca}^{n+1\text{trial}} = \sigma_{ca}^n + 2G_{ca}\Delta\varepsilon_{ca}$$

If $LCA > 0$, each component of the updated stress tensor is checked to ensure that it does not exceed the permissible value determined from the load curves, e.g., if

$$|\sigma_{ij}^{n+1\text{trial}}| > \lambda\sigma_{ij}(\varepsilon_{ij})$$

then

$$\sigma_{ij}^{n+1} = \sigma_{ij}(\varepsilon_{ij}) \frac{\lambda\sigma_{ij}^{n+1\text{trial}}}{|\sigma_{ij}^{n+1\text{trial}}|}$$

On Card 3 $\sigma_{ij}(\varepsilon_{ij})$ is defined in the load curve specified in columns 31-40 for the aa stress component, 41-50 for the bb component, 51-60 for the cc component, and 61-70 for the ab, bc, cb shear stress components. The parameter λ is either unity or a value taken from the load curve number, LCSR, that defines λ as a function of strain-rate. Strain-rate is defined here as the Euclidean norm of the deviatoric strain-rate tensor.

If $LCA < 0$, a transversely isotropic yield surface is obtained where the uniaxial limit stress, $\sigma^y(\varphi, \varepsilon^{\text{vol}})$, can be defined as a function of angle φ with the strong axis and volumetric strain, ε^{vol} . In order to facilitate the input of data to such a limit stress surface, the limit stress is written as:

$$\sigma^y(\varphi, \varepsilon^{\text{vol}}) = \sigma^b(\varphi) + (\cos\varphi)^2\sigma^s(\varepsilon^{\text{vol}}) + (\sin\varphi)^2\sigma^w(\varepsilon^{\text{vol}})$$

where the functions σ^b , σ^s , and σ^w are represented by load curves LCA, LCB, LCC, respectively. The latter two curves can be used to include the stiffening effects that are observed as the foam material crushes to the point where it begins to lock up. To ensure that the limit stress decreases with respect to the off-angle the curves should be defined such that following equations hold:

$$\frac{\partial\sigma^b(\varphi)}{\partial\varphi} \leq 0$$

and

$$\sigma^s(\varepsilon^{\text{vol}}) - \sigma^w(\varepsilon^{\text{vol}}) \geq 0.$$

A drawback of this implementation was that the material often collapsed in shear mode due to low shear resistance. There was no way of increasing the shear resistance without

changing the behavior in pure uniaxial compression. We have therefore modified the model so that the user can optionally prescribe the shear and hydrostatic resistance in the material without affecting the uniaxial behavior. We introduce the parameters $\sigma_p^Y(\varepsilon^{\text{vol}})$ and $\sigma_d^Y(\varepsilon^{\text{vol}})$ as the *hydrostatic* and *shear limit stresses*, respectively. These are functions of the volumetric strain and are assumed given by

$$\begin{aligned}\sigma_p^Y(\varepsilon^{\text{vol}}) &= \sigma_p^Y + \sigma^s(\varepsilon^{\text{vol}}) \\ \sigma_d^Y(\varepsilon^{\text{vol}}) &= \sigma_d^Y + \sigma^s(\varepsilon^{\text{vol}})'\end{aligned}$$

where we have reused the densification function σ^s . The new parameters are the initial hydrostatic and shear limit stress values, σ_p^Y and σ_d^Y , and are provided by the user as GCAU and |ECCU|, respectively. The negative sign of ECCU flags the third yield surface option whenever $LCA < 0$. The effect of the third formulation is that (i) for a uniaxial stress the stress limit is given by $\sigma^Y(\phi, \varepsilon^{\text{vol}})$, (ii) for a pressure the stress limit is given by $\sigma_p^Y(\varepsilon^{\text{vol}})$ and (iii) for a simple shear the stress limit is given by $\sigma_d^Y(\varepsilon^{\text{vol}})$. Experiments have shown that the model may give noisy responses and inhomogeneous deformation modes if parameters are not chosen with care. We therefore recommend to (i) avoid large slopes in the function σ^P , (ii) let the functions σ^s and σ^w be slightly increasing and (iii) avoid large differences between the stress limit values $\sigma^y(\phi, \varepsilon^{\text{vol}})$, $\sigma_p^Y(\varepsilon^{\text{vol}})$ and $\sigma_d^Y(\varepsilon^{\text{vol}})$. These guidelines are likely to contradict how one would interpret test data and it is up to the user to find a reasonable trade-off between matching experimental results and avoiding the mentioned numerical side effects.

For fully compacted material (element formulations 1 and 2), we assume that the material behavior is elastic-perfectly plastic and updated the stress components according to:

$$s_{ij}^{\text{trial}} = s_{ij}^n + 2G\Delta\varepsilon_{ij}^{\text{dev}n+1/2}$$

where the deviatoric strain increment is defined as

$$\Delta\varepsilon_{ij}^{\text{dev}} = \Delta\varepsilon_{ij} - \frac{1}{3}\Delta\varepsilon_{kk}\delta_{ij}.$$

We now check to see if the yield stress for the fully compacted material is exceeded by comparing

$$s_{\text{eff}}^{\text{trial}} = \left(\frac{3}{2}s_{ij}^{\text{trial}}s_{ij}^{\text{trial}}\right)^{1/2}$$

the effective trial stress to the yield stress, σ_y (Card 1, field 41-50). If the effective trial stress exceeds the yield stress we simply scale back the stress components to the yield surface

$$s_{ij}^{n+1} = \frac{\sigma_y}{s_{\text{eff}}^{\text{trial}}}s_{ij}^{\text{trial}}.$$

We can now update the pressure using the elastic bulk modulus, K

$$p^{n+1} = p^n - K\Delta\varepsilon_{kk}^{n+1/2}$$

$$K = \frac{E}{3(1 - 2\nu)}$$

and obtain the final value for the Cauchy stress

$$\sigma_{ij}^{n+1} = s_{ij}^{n+1} - p^{n+1}\delta_{ij}$$

After completing the stress update we transform the stresses back to the global configuration.

For *CONSTRAINED_TIED_NODES_WITH_FAILURE, the failure is based on the volume strain instead to the plastic strain.

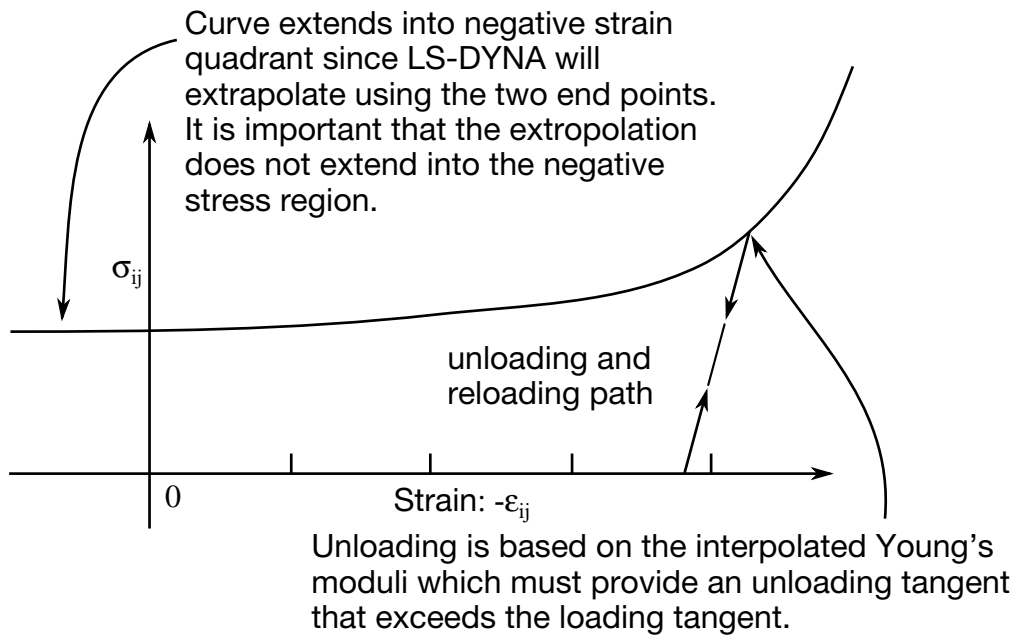

Figure 2-71. Stress versus strain. Note that the “yield stress” at a strain of zero is nonzero. In the load curve definition the “time” value is the directional strain and the “function” value is the yield stress. Note that for element types 0 and 9 engineering strains are used, but for all other element types the rates are integrated in time.

***MAT_ARRUDA_BOYCE_RUBBER**

This is Material Type 127. This material model provides a hyperelastic rubber model, see [Arruda and Boyce 1993] combined optionally with linear viscoelasticity as outlined by [Christensen 1980].

Card 1	1	2	3	4	5	6	7	8
Variable	MID	RO	K	G	N			
Type	A8	F	F	F	F			

Card 2	1	2	3	4	5	6	7	8
Variable	LCID	TRAMP	NT					
Type	F	F	F					

Viscoelastic Constant Cards. Up to 6 cards may be input. A keyword card (with a "*" in column 1) terminates this input if less than 6 cards are used.

Card 3	1	2	3	4	5	6	7	8
Variable	GI	BETA1						
Type	F	F						

VARIABLE**DESCRIPTION**

MID	Material identification. A unique number or label not exceeding 8 characters must be specified.
RO	Mass density
K	Bulk modulus
G	Shear modulus
N	Number of statistical links

VARIABLE	DESCRIPTION
LCID	Optional load curve ID of relaxation curve if constants β_I are determined via a least squares fit. This relaxation curve is shown in Figure 2-44 . This model ignores the constant stress.
TRAMP	Optional ramp time for loading.
NT	Number of Prony series terms in optional fit. If zero, the default is 6. Currently, the maximum number is 6. Values less than 6, possibly 3-5 are recommended, since each term used adds significantly to the cost. Caution should be exercised when taking the results from the fit. Always check the results of the fit in the output file. Preferably, all generated coefficients should be positive. Negative values may lead to unstable results. Once a satisfactory fit has been achieved it is recommended that the coefficients which are written into the output file be input in future runs.
GI	Optional shear relaxation modulus for the i th term.
BETAI	Optional decay constant if i th term.

Remarks:

Rubber is generally considered to be fully incompressible since the bulk modulus greatly exceeds the shear modulus in magnitude. To model the rubber as an unconstrained material a hydrostatic work term, $W_H(J)$, is included in the strain energy functional which is function of the relative volume, J , [Ogden 1984]:

$$W(J_1, J_2, J) = nk\theta \left[\frac{1}{2}(J_1 - 3) + \frac{1}{20N}(J_1^2 - 9) + \frac{11}{1050N^2}(J_1^3 - 27) \right] \\ + nk\theta \left[\frac{19}{7000N^3}(J_1^4 - 81) + \frac{519}{673750N^4}(J_1^5 - 243) \right] + W_H(J)$$

where the hydrostatic work term is in terms of the bulk modulus, K , and the third invariant, J , as:

$$W_H(J) = \frac{K}{2}(J - 1)^2$$

Rate effects are taken into account through linear viscoelasticity by a convolution integral of the form:

$$\sigma_{ij} = \int_0^t g_{ijkl}(t - \tau) \frac{\partial \varepsilon_{kl}}{\partial \tau} d\tau$$

or in terms of the second Piola-Kirchhoff stress, S_{ij} , and Green's strain tensor, E_{ij} ,

$$S_{ij} = \int_0^t G_{ijkl}(t - \tau) \frac{\partial E_{kl}}{\partial \tau} d\tau$$

where $g_{ijkl}(t - \tau)$ and $G_{ijkl}(t - \tau)$ are the relaxation functions for the different stress measures. This stress is added to the stress tensor determined from the strain energy functional.

If we wish to include only simple rate effects, the relaxation function is represented by six terms from the Prony series:

$$g(t) = \alpha_0 + \sum_{m=1}^N \alpha_m e^{-\beta t}$$

given by,

$$g(t) = \sum_{i=1}^n G_i e^{-\beta_i t}$$

This model is effectively a Maxwell fluid which consists of a dampers and springs in series. We characterize this in the input by shear moduli, G_i , and decay constants, β_i . The viscoelastic behavior is optional and an arbitrary number of terms may be used.

***MAT_HEART_TISSUE**

This is Material Type 128. This material model provides a heart tissue model described in the paper by Walker *et al* [2005] as interpreted by Kay Sun. It is backward compatible with an earlier heart tissue model described in the paper by Guccione, McCulloch, and Waldman [1991]. Both models are transversely isotropic.

Card 1	1	2	3	4	5	6	7	8
Variable	MID	R0	C	B1	B2	B3	P	B
Type	A8	F	F	F	F	F	F	F

Skip to Card 3 to activate older Guccione, McCulloch, and Waldman [1991] model.

Card 2	1	2	3	4	5	6	7	8
Variable	L0	CA0MAX	LR	M	BB	CA0	TMAX	TACT
Type	F	I						

Card 3	1	2	3	4	5	6	7	8
Variable	AOPT	MACF						
Type	F	I						

Card 4	1	2	3	4	5	6	7	8
Variable	XP	YP	ZP	A1	A2	A3		
Type	F	F	F	F	F	F		

Card 5	1	2	3	4	5	6	7	8
Variable	V1	V2	V3	D1	D2	D3	BETA	
Type	F	F	F	F	F	F	F	

VARIABLE**DESCRIPTION**

MID	Material identification. A unique number or label not exceeding 8 characters must be specified.
RO	Mass density
C	Diastolic material coefficient.
B1	b_1 , diastolic material coefficient.
B2	b_2 , diastolic material coefficient.
B3	b_3 , diastolic material coefficient.
P	Pressure in the muscle tissue
B	Systolic material coefficient. Omit for the earlier model.
L0	l_0 , sacromere length at which no active tension develops. Omit for the earlier model.
CA0MAX	$(Ca_0)_{\max}$, maximum peak intracellular calcium concentrate. Omit for the earlier model.
LR	l_R , Stress-free sacromere length. Omit for the earlier model.
M	Systolic material coefficient. Omit for the earlier model.
BB	Systolic material coefficient. Omit for the earlier model.
CA0	Ca_0 , peak intracellular calcium concentration. Omit for the earlier model.
TMAX	T_{\max} , maximum isometric tension achieved at the longest sacromere length. Omit for the earlier model.
TACT	t_{act} , time at which active contraction initiates. Omit for the earlier model

VARIABLE	DESCRIPTION
AOPT	<p>Material axes option (see MAT_OPTION TROPIC_ELASTIC for a more complete description):</p> <p>EQ.0.0: locally orthotropic with material axes determined by element nodes 1, 2, and 4, as with *DEFINE_COORDINATE_NODES.</p> <p>EQ.1.0: locally orthotropic with material axes determined by a point in space and the global location of the element center; this is the a-direction.</p> <p>EQ.2.0: globally orthotropic with material axes determined by vectors defined below, as with *DEFINE_COORDINATE_VECTOR.</p> <p>EQ.3.0: locally orthotropic material axes determined by rotating the material axes about the element normal by an angle, BETA, from a line in the plane of the element defined by the cross product of the vector v with the element normal.</p> <p>EQ.4.0: locally orthotropic in cylindrical coordinate system with the material axes determined by a vector v, and an originating point, P, which define the centerline axis.</p> <p>LT.0.0: the absolute value of AOPT is a coordinate system ID number (CID on *DEFINE_COORDINATE_NODES, *DEFINE_COORDINATE_SYSTEM or *DEFINE_COORDINATE_VECTOR). Available in R3 version of 971 and later.</p>
MACF	<p>Material axes change flag for brick elements:</p> <p>EQ.1: No change, default,</p> <p>EQ.2: switch material axes a and b,</p> <p>EQ.3: switch material axes a and c,</p> <p>EQ.4: switch material axes b and c.</p>
XP, YP, ZP	x_p y_p z_p , define coordinates of point p for AOPT = 1 and 4.
A1, A2, A3	a_1 a_2 a_3 , define components of vector a for AOPT = 2.
D1, D2, D3	d_1 d_2 d_3 , define components of vector d for AOPT = 2.
V1, V2, V3	v_1 v_2 v_3 , define components of vector v for AOPT = 3 and 4.

VARIABLE	DESCRIPTION
BETA	Material angle in degrees for AOPT = 3, may be overridden on the element card, see *ELEMENT_SOLID_ORTHO.

Remarks:

1. The tissue model is described in terms of the energy functional that is transversely isotropic with respect to the local fiber direction,

$$W = \frac{C}{2}(e^Q - 1)$$

$$Q = b_f E_{11}^2 + b_t (E_{22}^2 + E_{33}^2 + E_{23}^2 + E_{32}^2) + b_{fs} (E_{12}^2 + E_{21}^2 + E_{13}^2 + E_{31}^2)$$

with C , b_f , b_t , and b_{fs} material parameters and E the Lagrange-Green strains.

The systolic contraction was modeled as the sum of the passive stress derived from the strain energy function and an active fiber directional component, T_0 , which is a function of time, t ,

$$\underline{S} = \frac{\partial W}{\partial \underline{E}} - pJ\underline{C}^{-1} + T_0\{t, Ca_0, l\}$$

$$\underline{\sigma} = \frac{1}{J} \underline{E} \underline{S} \underline{E}^T$$

with \underline{S} the second Piola-Kirchoff stress tensor, \underline{C} the right Cauchy-Green deformation tensor, J the Jacobian of the deformation gradient tensor \underline{E} , and $\underline{\sigma}$ the Cauchy stress tensor.

The active fiber directional stress component is defined by a time-varying elastance model, which at end-systole, is reduced to

$$T_0 = T_{\max} \frac{Ca_0^2}{Ca_0^2 + ECa_{50}^2} C_t$$

with T_{\max} the maximum isometric tension achieved at the longest sacromere length and maximum peak intracellular calcium concentration. The length-dependent calcium sensitivity and internal variable is given by,

$$ECa_{50} = \frac{(Ca_0)_{\max}}{\sqrt{\exp[B(l - l_0)] - 1}}$$

$$C_t = 1/2(1 - \cos w)$$

$$l = l_R \sqrt{2E_{11} + 1}$$

$$w = \pi \frac{0.25 + t_r}{t_r}$$

$$t_r = ml + bb$$

A cross-fiber, in-plane stress equivalent to 40% of that along the myocardial fiber direction is added.

2. The earlier tissue model is described in terms of the energy functional in terms of the Green strain components, E_{ij} ,

$$W(E) = \frac{C}{2}(e^Q - 1) + \frac{1}{2}P(I_3 - 1)$$

$$Q = b_1 E_{11}^2 + b_2 (E_{22}^2 + E_{33}^2 + E_{23}^2 + E_{32}^2) + b_3 (E_{12}^2 + E_{21}^2 + E_{13}^2 + E_{31}^2)$$

The Green components are modified to eliminate any effects of volumetric work following the procedures of Ogden. See the paper by Guccione *et al* [1991] for more detail.

***MAT_LUNG_TISSUE**

This is Material Type 129. This material model provides a hyperelastic model for heart tissue, see [Vawter 1980] combined optionally with linear viscoelasticity as outlined by [Christensen 1980].

Card 1	1	2	3	4	5	6	7	8
Variable	MID	RO	K	C	DELTA	ALPHA	BETA	
Type	A8	F	F	F	I			

Card 2	1	2	3	4	5	6	7	8
Variable	C1	C2	LCID	TRAMP	NT			
Type	F	F	F	F	F			

Viscoelastic Constant Cards. Up to 6 cards may be input. A keyword card (with a "*" in column 1) terminates this input if less than 6 cards are used.

Card 3	1	2	3	4	5	6	7	8
Variable	GI	BETA1						
Type	F	F						

VARIABLE**DESCRIPTION**

MID	Material identification. A unique number or label not exceeding 8 characters must be specified.
RO	Mass density
K	Bulk modulus
C	Material coefficient.
DELTA	Δ , material coefficient.
ALPHA	α , material coefficient.

VARIABLE	DESCRIPTION
BETA	β , material coefficient.
C1	Material coefficient.
C2	Material coefficient.
LCID	Optional load curve ID of relaxation curve If constants β_i are determined via a least squares fit. This relaxation curve is shown in Figure 2-44 . This model ignores the constant stress.
TRAMP	Optional ramp time for loading.
NT	Number of Prony series terms in optional fit. If zero, the default is 6. Currently, the maximum number is 6. Values less than 6, possibly 3-5 are recommended, since each term used adds significantly to the cost. Caution should be exercised when taking the results from the fit. Always check the results of the fit in the output file. Preferably, all generated coefficients should be positive. Negative values may lead to unstable results. Once a satisfactory fit has been achieved it is recommended that the coefficients which are written into the output file be input in future runs.
GI	Optional shear relaxation modulus for the i th term
BETAI	Optional decay constant if i th term

Remarks:

The material is described by a strain energy functional expressed in terms of the invariants of the Green Strain:

$$W(I_1, I_2) = \frac{C}{2\Delta} e^{(\alpha I_1^2 + \beta I_2)} + \frac{12C_1}{\Delta(1 + C_2)} [A^{(1+C_2)} - 1]$$

$$A^2 = \frac{4}{3}(I_1 + I_2) - 1$$

where the hydrostatic work term is in terms of the bulk modulus, K , and the third invariant, J , as:

$$W_H(J) = \frac{K}{2}(J - 1)^2$$

Rate effects are taken into account through linear viscoelasticity by a convolution integral of the form:

$$\sigma_{ij} = \int_0^t g_{ijkl}(t - \tau) \frac{\partial \varepsilon_{kl}}{\partial \tau} d\tau$$

or in terms of the second Piola-Kirchhoff stress, S_{ij} , and Green's strain tensor, E_{ij} ,

$$S_{ij} = \int_0^t G_{ijkl}(t - \tau) \frac{\partial E_{kl}}{\partial \tau} d\tau$$

where $g_{ijkl}(t - \tau)$ and $G_{ijkl}(t - \tau)$ are the relaxation functions for the different stress measures. This stress is added to the stress tensor determined from the strain energy functional.

If we wish to include only simple rate effects, the relaxation function is represented by six terms from the Prony series:

$$g(t) = \alpha_0 + \sum_{m=1}^N \alpha_m e^{-\beta t}$$

given by,

$$g(t) = \sum_{i=1}^n G_i e^{-\beta_i t}$$

This model is effectively a Maxwell fluid which consists of a dampers and springs in series. We characterize this in the input by shear moduli, G_i , and decay constants, β_i . The viscoelastic behavior is optional and an arbitrary number of terms may be used.

***MAT_SPECIAL_ORTHOTROPIC**

This is Material Type 130. This model is available the Belytschko-Tsay and the C0 triangular shell elements and is based on a resultant stress formulation. In-plane behavior is treated separately from bending in order to model perforated materials such as television shadow masks. If other shell formulations are specified, the formulation will be automatically switched to Belytschko-Tsay. As implemented, this material model cannot be used with user defined integration rules.

Card 1	1	2	3	4	5	6	7	8
Variable	MID	RO	YS	EP				
Type	A8	F	F	F				

Card 2	1	2	3	4	5	6	7	8
Variable	E11P	E22P	V12P	V21P	G12P	G23P	G31P	
Type	F	F	F	F	F	F	F	

Card 3	1	2	3	4	5	6	7	8
Variable	E11B	E22B	V12B	V21B	G12B	A0PT		
Type	F	F	F	F	F	F		

Card 4	1	2	3	4	5	6	7	8
Variable				A1	A2	A3		
Type				F	F	F		

Card 5	1	2	3	4	5	6	7	8
Variable	V1	V2	V3	D1	D2	D3	BETA	
Type	F	F	F	F	F	F	F	

VARIABLE**DESCRIPTION**

MID	Material identification. A unique number or label not exceeding 8 characters must be specified.
RO	Mass density.
YS	Yield stress. This parameter is optional and is approximates the yield condition. Set to zero if the behavior is elastic.
EP	Plastic hardening modulus.
E11P	E_{11p} , for in plane behavior.
E22P	E_{22p} , for in plane behavior.
V12P	ν_{12p} , for in plane behavior.
V11P	ν_{21p} , for in plane behavior.
G12P	G_{12p} , for in plane behavior.
G23P	G_{23p} , for in plane behavior.
G31P	G_{31p} , for in plane behavior.
E11B	E_{11b} , for bending behavior.
E22B	E_{22b} , for bending behavior.
V12B	ν_{12b} , for bending behavior.
V21B	ν_{21b} , for bending behavior.
G12B	G_{12b} , for bending behavior.

VARIABLE	DESCRIPTION
AOPT	<p>Material axes option (see MAT_OPTIONTROPIC_ELASTIC for a more complete description):</p> <p>EQ.0.0: locally orthotropic with material axes determined by element nodes 1, 2, and 4, as with *DEFINE_COORDINATE_NODES, and then rotated about the shell element normal by an angle BETA.</p> <p>EQ.2.0: globally orthotropic with material axes determined by vectors defined below, as with *DEFINE_COORDINATE_VECTOR.</p> <p>EQ.3.0: locally orthotropic material axes determined by rotating the material axes about the element normal by an angle, BETA, from a line in the plane of the element defined by the cross product of the vector \mathbf{v} with the element normal.</p> <p>LT.0.0: the absolute value of AOPT is a coordinate system ID number (CID on *DEFINE_COORDINATE_NODES, *DEFINE_COORDINATE_SYSTEM or *DEFINE_COORDINATE_VECTOR). Available in R3 version of 971 and later.</p>
A1,A2,A3	$a_1 a_2 a_3$, define components of vector \mathbf{a} for AOPT = 2.
D1,D2,D3	$d_1 d_2 d_3$, define components of vector \mathbf{d} for AOPT = 2.
V1,V2,V3	$v_1 v_2 v_3$, define components of vector \mathbf{v} for AOPT = 3.
BETA	Material angle in degrees for AOPT = 0 and 3, may be overridden on the element card, see *ELEMENT_SHELL_BETA.

Remarks:

The in-plane elastic matrix for in-plane, plane stress behavior is given by:

$$C_{\text{in plane}} = \begin{bmatrix} Q_{11p} & Q_{12p} & 0 & 0 & 0 \\ Q_{12p} & Q_{22p} & 0 & 0 & 0 \\ 0 & 0 & Q_{44p} & 0 & 0 \\ 0 & 0 & 0 & Q_{55p} & 0 \\ 0 & 0 & 0 & 0 & Q_{66p} \end{bmatrix}$$

The terms Q_{ijp} are defined as:

$$Q_{11p} = \frac{E_{11p}}{1 - \nu_{12p}\nu_{21p}}$$

$$Q_{22p} = \frac{E_{22p}}{1 - \nu_{12p}\nu_{21p}}$$

$$Q_{12p} = \frac{\nu_{12p}E_{11p}}{1 - \nu_{12p}\nu_{21p}}$$

$$Q_{44p} = G_{12p}$$

$$Q_{55p} = G_{23p}$$

$$Q_{66p} = G_{31p}$$

The elastic matrix for bending behavior is given by:

$$C_{\text{bending}} = \begin{bmatrix} Q_{11b} & Q_{12b} & 0 \\ Q_{12b} & Q_{22b} & 0 \\ 0 & 0 & Q_{44b} \end{bmatrix}$$

The terms Q_{ijp} are similarly defined.

***MAT_ISOTROPIC_SMEARED_CRACK**

This is Material Type 131. This model was developed by Lemmen and Meijer [2001] as a smeared crack model for isotropic materials. This model is available of solid elements only and is restricted to cracks in the x-y plane. Users should choose other models unless they have the report by Lemmen and Meijer [2001].

Card 1	1	2	3	4	5	6	7	8
Variable	MID	RO	E	PR	ISPL	SIGF	GK	SR
Type	A8	F	F	F	I	F	F	F

VARIABLE**DESCRIPTION**

MID	Material identification. A unique number or label not exceeding 8 characters must be specified.
RO	Mass density
E	Young's modulus
PR	Poisson's ratio
ISPL	Failure option: EQ.0: Maximum principal stress criterion EQ.5: Smeared crack model EQ.6: Damage model based on modified von Mises strain
SIGF	Peak stress.
GK	Critical energy release rate.
SR	Strength ratio.

Remarks:

The following documentation is taken nearly verbatim from the documentation of Lemmen and Meijer [2001].

Three methods are offered to model progressive failure. The maximum principal stress criterion detects failure if the maximum (most tensile) principal stress exceeds σ_{\max} . Upon failure, the material can no longer carry stress.

The second failure model is the smeared crack model with linear softening stress-strain using equivalent uniaxial strains. Failure is assumed to be perpendicular to the principal strain directions. A rotational crack concept is employed in which the crack directions are related to the current directions of principal strain. Therefore crack directions may rotate in time. Principal stresses are expressed as

$$\begin{pmatrix} \sigma_1 \\ \sigma_2 \\ \sigma_3 \end{pmatrix} = \begin{bmatrix} \bar{E}_1 & 0 & 0 \\ 0 & \bar{E}_2 & 0 \\ 0 & 0 & \bar{E}_3 \end{bmatrix} \begin{pmatrix} \tilde{\epsilon}_1 \\ \tilde{\epsilon}_2 \\ \tilde{\epsilon}_3 \end{pmatrix} = \begin{pmatrix} \bar{E}_1 \tilde{\epsilon}_1 \\ \bar{E}_2 \tilde{\epsilon}_2 \\ \bar{E}_3 \tilde{\epsilon}_3 \end{pmatrix} \quad (131.1)$$

with \bar{E}_1 , \bar{E}_2 and \bar{E}_3 secant stiffness in the terms that depend on internal variables.

In the model developed for DYCOSS it has been assumed that there is no interaction between the three directions in which case stresses simply follow from

$$\sigma_j(\tilde{\epsilon}_j) = \begin{cases} E\tilde{\epsilon}_j & \text{if } 0 \leq \tilde{\epsilon}_j \leq \tilde{\epsilon}_{j,\text{ini}} \\ \bar{\sigma} \left(1 - \frac{\tilde{\epsilon}_j - \tilde{\epsilon}_{j,\text{ini}}}{\tilde{\epsilon}_{j,\text{ult}} - \tilde{\epsilon}_{j,\text{ini}}} \right) & \text{if } \tilde{\epsilon}_{j,\text{ini}} < \tilde{\epsilon}_j \leq \tilde{\epsilon}_{j,\text{ult}} \\ 0 & \text{if } \tilde{\epsilon}_j > \tilde{\epsilon}_{j,\text{ult}} \end{cases} \quad (131.2)$$

with $\bar{\sigma}$ the ultimate stress, $\tilde{\epsilon}_{j,\text{ini}}$ the damage threshold, and $\tilde{\epsilon}_{j,\text{ult}}$ the ultimate strain in j -direction. The damage threshold is defined as

$$\tilde{\epsilon}_{j,\text{ini}} = \frac{\bar{\sigma}}{E} \quad (131.3)$$

The ultimate strain is obtained by relating the crack growth energy and the dissipated energy

$$\int \int \bar{\sigma} d\tilde{\epsilon}_{j,\text{ult}} dV = GA \quad (131.4)$$

with G the energy release rate, V the element volume and A the area perpendicular to the principal strain direction. The one point elements LS-DYNA have a single integration point and the integral over the volume may be replaced by the volume. For linear softening it follows

$$\tilde{\epsilon}_{j,\text{ult}} = \frac{2GA}{V\bar{\sigma}} \quad (131.5)$$

The above formulation may be regarded as a damage equivalent to the maximum principle stress criterion.

The third model is a damage model represented by Brekelmans et. al [1991]. Here the Cauchy stress tensor σ is expressed as

$$\sigma = (1 - D)E\epsilon \quad (131.6)$$

where D represents the current damage and the factor $(1-D)$ is the reduction factor caused by damage. The scalar damage variable is expressed as function of a so-called damage equivalent strain ϵd

$$D = D(\varepsilon d) = 1 - \frac{\varepsilon_{ini}(\varepsilon_{ult} - \varepsilon_d)}{\varepsilon_d(\varepsilon_{ult} - \varepsilon_{ini})} \quad (131.7)$$

and

$$\varepsilon d = \frac{k-1}{2k(1-2\nu)} J_1 + \frac{1}{2k} \sqrt{\left(\frac{k-1}{1-2\nu} J_1\right)^2 + \frac{6k}{(1+\nu)^2} J_2} \quad (131.8)$$

where the constant k represents the ratio of the strength in tension over the strength in compression

$$k = \frac{\sigma_{ult, tension}}{\sigma_{ult, compression}} \quad (131.9)$$

J_1 resp. J_2 are the first and second invariant of the strain tensor representing the volumetric and the deviatoric straining respectively

$$\begin{aligned} J_1 &= \text{tr}(\varepsilon) \\ J_2 &= \text{tr}(\varepsilon \cdot \varepsilon) - \frac{1}{3} [\text{tr}(\varepsilon)]^2 \end{aligned} \quad (131.10)$$

If the compression and tension strength are equal the dependency on the volumetric strain vanishes in (8) and failure is shear dominated. If the compressive strength is much larger than the strength in tension, k becomes small and the J_1 terms in (131.8) dominate the behavior.

MAT_132**MAT_ORTHOTROPIC_SMEARED_CRACK*****MAT_ORTHOTROPIC_SMEARED_CRACK**

This is Material Type 132. This material is a smeared crack model for orthotropic materials.

Card 1	1	2	3	4	5	6	7	8
Variable	MID	RO	EA	EB	EC	PRBA	PRCA	PRCB
Type	A8	F	F	F	F	F	F	F

Card 2	1	2	3	4	5	6	7	8
Variable	UINS	UISS	CERRMI	CERRMII	IND	ISD		
Type	F	F	F	F	I	I		

Card 3	1	2	3	4	5	6	7	8
Variable	GAB	GBC	GCA	AOPT				
Type	F	F	F	F				

Card 4	1	2	3	4	5	6	7	8
Variable	XP	YP	ZP	A1	A2	A3	MACF	
Type	F	F	F	F	F	F	I	

Card 5	1	2	3	4	5	6	7	8
Variable	V1	V2	V3	D1	D2	D3	BETA	REF
Type	F	F	F	F	F	F	F	F

VARIABLE	DESCRIPTION
MID	Material identification. A unique number or label not exceeding 8 characters must be specified.
RO	Mass density.
EA	E_a , Young's modulus in a -direction.
EB	E_b , Young's modulus in b -direction.
EC	E_c , Young's modulus in c -direction
PRBA	ν_{ba} , Poisson's ratio ba .
PRCA	ν_{ca} , Poisson's ratio ca .
PRCB	ν_{cb} , Poisson's ratio cb .
UINS	Ultimate interlaminar normal stress.
UISS	Ultimate interlaminar shear stress.
CERRMI	Critical energy release rate mode I
CERRMII	Critical energy release rate mode II
IND	Interlaminar normal direction : EQ.1.0: Along local a axis EQ.2.0: Along local b axis EQ.3.0: Along local c axis
ISD	Interlaminar shear direction : EQ.4.0: Along local ab axis EQ.5.0: Along local bc axis EQ.6.0: Along local ca axis
GAB	G_{ab} , shear modulus ab.
GBC	G_{bc} , shear modulus bc.
GCA	G_{ca} , shear modulus ca.

VARIABLE	DESCRIPTION
AOPT	<p>Material axes option, see Figure 2-3.</p> <p>EQ.0.0: locally orthotropic with material axes determined by element nodes as shown in Figure 2-3. Nodes 1, 2, and 4 of an element are identical to the nodes used for the definition of a coordinate system as by *DEFINE_COORDINATE_NODES.</p> <p>EQ.1.0: locally orthotropic with material axes determined by a point in space and the global location of the element center; this is the a-direction. This option is for solid elements only.</p> <p>EQ.2.0: globally orthotropic with material axes determined by vectors defined below, as with *DEFINE_COORDINATE_VECTOR.</p> <p>EQ.3.0: locally orthotropic material axes determined by rotating the material axes about the element normal by an angle, BETA, from a line in the plane of the element defined by the cross product of the vector v with the element normal. The plane of a solid element is the midsurface between the inner surface and outer surface defined by the first four nodes and the last four nodes of the connectivity of the element, respectively.</p> <p>EQ.4.0: locally orthotropic in cylindrical coordinate system with the material axes determined by a vector v, and an originating point, P, which define the centerline axis. This option is for solid elements only.</p> <p>LT.0.0: the absolute value of AOPT is a coordinate system ID number (CID on *DEFINE_COORDINATE_NODES, *DEFINE_COORDINATE_SYSTEM or *DEFINE_COORDINATE_VECTOR). Available in R3 version of 971 and later.</p>
XP YP ZP	Define coordinates of point p for AOPT = 1 and 4.
A1 A2 A3	Define components of vector a for AOPT = 2.

VARIABLE	DESCRIPTION
MACF	Material axes change flag for brick elements: EQ.1: No change, default, EQ.2: switch material axes a and b, EQ.3: switch material axes a and c, EQ.4: switch material axes b and c.
V1 V2 V3	Define components of vector v for AOPT = 3 and 4.
D1 D2 D3	Define components of vector d for AOPT = 2:
BETA	Material angle in degrees for AOPT = 3, may be overridden on the element card, see *ELEMENT_SOLID_ORTHO.
REF	Use reference geometry to initialize the stress tensor. The reference geometry is defined by the keyword: *INITIAL_FOAM_REFERENCE_GEOMETRY (see there for more details). EQ.0.0: off, EQ.1.0: on.

Remarks:

This is an orthotropic material with optional delamination failure for brittle composites. The elastic formulation is identical to the DYNA3D model that uses total strain formulation. The constitutive matrix **C** that relates to global components of stress to the global components of strain is defined as:

$$C = T^T C_L T$$

where **T** is the transformation matrix between the local material coordinate system and the global system and C_L is the constitutive matrix defined in terms of the material constants of the local orthogonal material axes *a*, *b*, and *c* (see DYNA3D use manual).

Failure is described using linear softening stress strain curves for interlaminar normal and interlaminar shear direction. The current implementation for failure is essentially 2-D. Damage can occur in interlaminar normal direction and a single interlaminar shear direction. The orientation of these directions w.r.t. the principal material directions have to be specified by the user.

Based on specified values for the ultimate stress and the critical energy release rate bounding surfaces are defined

$$f_n = \sigma_n - \bar{\sigma}_n(\epsilon_n)$$

$$f_s = \sigma_s - \bar{\sigma}_s(\epsilon_s)$$

where the subscripts n and s refer to the normal and shear component. If stresses exceed the bounding surfaces inelastic straining occurs. The ultimate strain is obtained by relating the crack growth energy and the dissipated energy. For solid elements with a single integration point it can be derived

$$\epsilon_{i,ult} = \frac{2G_i A}{V\sigma_{i,ult}}$$

with G_i the critical energy release rate, V the element volume, A the area perpendicular to the active normal direction and $\sigma_{i,ult}$ the ultimate stress. For the normal component failure can only occur under tensile loading. For shear component the behavior is symmetric around zero. The resulting stress bounds are depicted in [Figure 2-72](#). Unloading is modeled with a Secant stiffness.

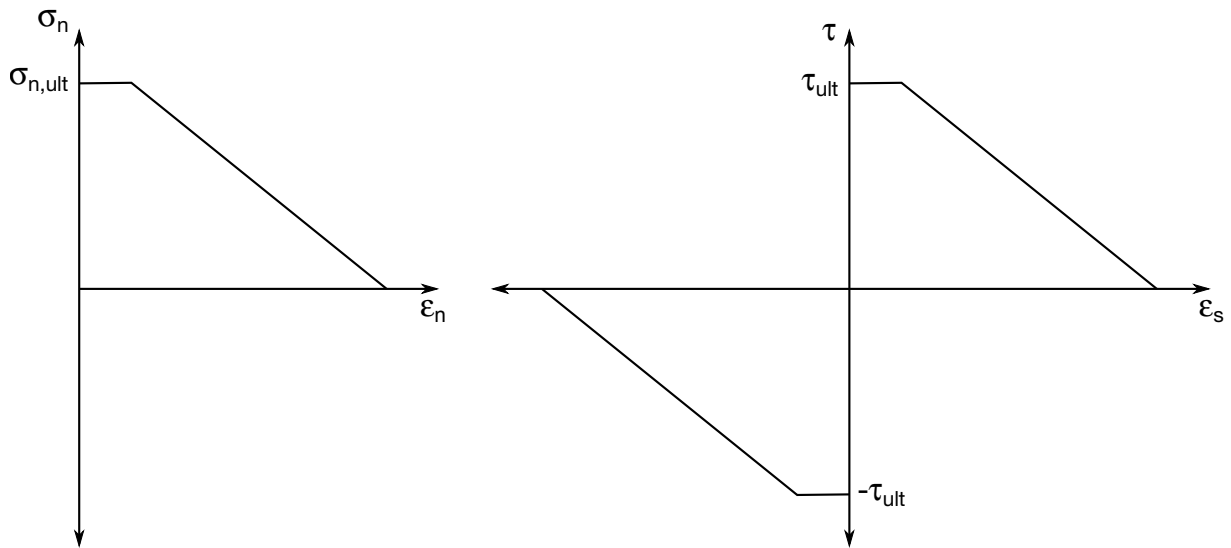

Figure 2-72. Shows stress bounds for the active normal component (left) and the archive shear component (right).

*MAT_BARLAT_YLD2000

This is Material Type 133. This model was developed by Barlat et al. [2003] to overcome some shortcomings of the six parameter Barlat model implemented as material 33 (MAT_BARLAT_YLD96) in LS-DYNA. This model is available for shell elements only.

Card 1	1	2	3	4	5	6	7	8
Variable	MID	R0	E	PR	FIT	BETA	ITER	ISCALE
Type	A8	F	F	F	F	F	F	F

Card 2	1	2	3	4	5	6	7	8
Variable	K	E0	N	C	P	HARD	A	
Type	F	F	F	F	F	F	F	

Chaboche-Roussilier Card. Additional Card for $A < 0$.

Card 3	1	2	3	4	5	6	7	8
Variable	CRC1	CRA1	CRC2	CRA2	CRC3	CRA3	CRC4	CRA4
Type	F	F	F	F	F	F	F	F

Direct Material Parameter Card. Additional card for $FIT = 0$.

Card 4	1	2	3	4	5	6	7	8
Variable	ALPHA1	ALPHA2	ALPHA3	ALPHA4	ALPHA5	ALPHA6	ALPHA7	ALPHA8
Type	F	F	F	F	F	F	F	F

Test Data Card 1. Additional Card for FIT = 1.

Card 5	1	2	3	4	5	6	7	8
Variable	SIG00	SIG45	SIG90	R00	R45	R90		
Type	F	F	F	F	F	F		

Test Data Card 2. Additional Card for FIT = 1.

Card 6	1	2	3	4	5	6	7	8
Variable	SIGXX	SIGYY	SIGXY	DXX	DYY	DXY		
Type	F	F	F	F	F	F		

Hansel Hardening Card 1. Additional Card for HARD = 3.

Card 7	1	2	3	4	5	6	7	8
Variable	CP	T0	TREF	TA0				
Type	F	F	F	F				

Hansel Hardening Card 2. Additional Card for HARD = 3.

Card 8	1	2	3	4	5	6	7	8
Variable	A	B	C	D	P	Q	EOMART	VM0
Type	F	F	F	F	F	F	F	F

Hansel Hardening Card 3. Additional Card for HARD = 3.

Card 9	1	2	3	4	5	6	7	8
Variable	AHS	BHS	M	N	EPS0	HMART	K1	K2
Type	F	F	F	F	F	F	F	F

Card 10	1	2	3	4	5	6	7	8
Variable	AOPT	OFFANG	P4	HTFLAG	HTA	HTB	HTC	HTD
Type	F	F	F	F	F	F	F	F

Card 11	1	2	3	4	5	6	7	8
Variable				A1	A2	A3		
Type				F	F	F		

Card 12	1	2	3	4	5	6	7	8
Variable	V1	V2	V3	D1	D2	D3	USRFAIL	
Type	F	F	F	F	F	F	F	

VARIABLE**DESCRIPTION**

MID	Material identification. A unique number or label not exceeding 8 characters must be specified.
RO	Mass density
E	Young's modulus LE.0: -E is load curve ID for Young's modulus vs. plastic strain
PR	Poisson's ratio

VARIABLE	DESCRIPTION
FIT	<p>Material parameter fit flag:</p> <p>EQ.0.0: Material parameters are used directly on card 3.</p> <p>EQ.1.0: Material parameters are determined from test data on cards 3 and 4</p>
BETA	<p>Hardening parameter. Any value ranging from 0 (isotropic hardening) to 1 (kinematic hardening) may be input.</p>
ITER	<p>Plastic iteration flag:</p> <p>EQ.0.0: Plane stress algorithm for stress return</p> <p>EQ.1.0: Secant iteration algorithm for stress return</p> <p>ITER provides an option of using three secant iterations for determining the thickness strain increment as experiments have shown that this leads to a more accurate prediction of shell thickness changes for rapid processes. A significant increase in computation time is incurred with this option so it should be used only for applications associated with high rates of loading and/or for implicit analysis.</p>
ISCALE	<p>Yield locus scaling flag:</p> <p>EQ.0.0: Scaling on – reference direction = rolling direction (default)</p> <p>EQ.1.0: Scaling off – reference direction arbitrary</p>
K	<p>Material parameter:</p> <p>HARD.EQ.1.0: k, strength coefficient for exponential hardening</p> <p>HARD.EQ.2.0: a in Voce hardening law</p> <p>HARD.EQ.4.0: k, strength coefficient for Gosh hardening</p> <p>HARD.EQ.5.0: a in Hockett-Sherby hardening law</p>
E0	<p>Material parameter:</p> <p>HARD.EQ.1.0: ϵ_0, strain at yield for exponential hardening</p> <p>HARD.EQ.2.0: b in Voce hardening law</p> <p>HARD.EQ.4.0: ϵ_0, strain at yield for Gosh hardening</p> <p>HARD.EQ.5.0: b in Hockett-Sherby hardening law</p>

VARIABLE	DESCRIPTION
N	Material parameter: HARD.EQ.1.0: n, exponent for exponential hardening HARD.EQ.2.0: c in Voce hardening law HARD.EQ.4.0: n, exponent for Gosh hardening HARD.EQ.5.0: c in Hocket-Sherby hardening law
C	Cowper-Symonds strain rate parameter, C, see formula below.
P	Cowper-Symonds strain rate parameter, p. $\sigma_y^v(\varepsilon_p, \dot{\varepsilon}_p) = \sigma_y(\varepsilon_p) \left(1 + \left\{ \frac{\dot{\varepsilon}_p}{C} \right\}^{1/p} \right)$
HARD	Hardening law: EQ.1.0: Exponential hardening: $\sigma_y = k(\varepsilon_0 + \varepsilon_p)^n$ EQ.2.0: Voce hardening: $\sigma_y = a - be^{-c \varepsilon_p}$ EQ.3.0: Hansel hardening EQ.4.0: Gosh hardening: $\sigma_y = k(\varepsilon_0 + \varepsilon_p)^n - p$ EQ.5.0: Hocket-Sherby hardening: $\sigma_y = a - be^{-c \varepsilon_p^q}$ LT.0.0: Absolute value defines load curve ID or table ID with yield stress as functions of plastic strain and in the latter case also plastic strain rate.
A	Flow potential exponent
CRCN	Chaboche-Roussilier kinematic hardening parameter, see remarks.
CRCA	Chaboche-Roussilier kinematic hardening parameter, see remarks.
ALPHA1	α_1 , see equations below
ALPHA2	α_2 , see equations below
ALPHA3	α_3 , see equations below
ALPHA4	α_4 , see equations below
ALPHA5	α_5 , see equations below

VARIABLE	DESCRIPTION
ALPHA6	α_6 , see equations below
ALPHA7	α_7 , see equations below
ALPHA8	α_8 , see equations below
SIG00	Yield stress in 00 direction
SIG45	Yield stress in 45 direction
SIG90	Yield stress in 90 direction
R00	R-value in 00 direction
R45	R-value in 45 direction
R90	R-value in 90 direction
SIGXX	xx-component of stress on yield surface (See Remark 2).
SIGYY	yy-component of stress on yield surface (See Remark 2).
SIGXY	xy-component of stress on yield surface (See Remark 2).
DXX	xx-component of tangent to yield surface (See Remark 2).
DYY	yy-component of tangent to yield surface (See Remark 2).
DXY	xy-component of tangent to yield surface (See Remark 2).
CP	Adiabatic temperature calculation option : EQ.0.0: Adiabatic temperature calculation is disabled. GT.0.0: CP is the specific heat C_p . Adiabatic temperature calculation is enabled.
T0	Initial temperature T_0 of the material if adiabatic temperature calculation is enabled.
TREF	Reference temperature for output of the yield stress as history variable.
TA0	Reference temperature T_{A0} , the absolute zero for the used temperature scale, e.g. -273.15 if the Celsius scale is used and 0.0 if the Kelvin scale is used.

VARIABLE	DESCRIPTION
A	Martensite rate equation parameter A , see equations below.
B	Martensite rate equation parameter B , see equations below.
C	Martensite rate equation parameter C , see equations below.
D	Martensite rate equation parameter D , see equations below.
P	Martensite rate equation parameter p , see equations below.
Q	Martensite rate equation parameter Q , see equations below.
E0MART	Martensite rate equation parameter $E_{0(mart)}$, see equations below.
VM0	The initial volume fraction of martensite $0.0 < V_{m0} < 1.0$ may be initialised using two different methods: GT.0.0: V_{m0} is set to VM0. LT.0.0: Can be used only when there are initial plastic strains ϵ^p present, e.g. when using *INITIAL_STRESS_SHELL. The absolute value of VM0 is then the load curve ID for a function f that sets $V_{m0} = f(\epsilon^p)$. The function f must be a monotonically nondecreasing function of ϵ^p .
AHS	Hardening law parameter A_{HS} , see equations below.
BHS	Hardening law parameter B_{HS} , see equations below.
M	Hardening law parameter m , see equations below.
N	Hardening law parameter n , see equations below.
EPS0	Hardening law parameter ϵ_0 , see equations below.
HMART	Hardening law parameter $\Delta H_{\gamma \rightarrow \alpha'}$, see equations below.
K1	Hardening law parameter K_1 , see equations below.
K2	Hardening law parameter K_2 , see equations below.

VARIABLE	DESCRIPTION
AOPT	<p>Material axes option:</p> <p>EQ.0.0: locally orthotropic with material axes determined by element nodes as shown in Figure 2-3. Nodes 1, 2, and 4 of an element are identical to the nodes used for the definition of a coordinate system as by *DEFINE_COORDINATE_NODES</p> <p>EQ.2.0: globally orthotropic with material axes determined by vectors defined below, as with *DEFINE_COORDINATE_VECTOR</p> <p>EQ.3.0: locally orthotropic material axes determined by offsetting the material axes by an angle, OFFANG, from a line determined by taking the cross product of the vector v with the normal to the plane of the element.</p> <p>LT.0.0: the absolute value of AOPT is a coordinate system ID number (CID on *DEFINE_COORDINATE_NODES, *DEFINE_COORDINATE_SYSTEM or *DEFINE_COORDINATE_VECTOR). Available in R3 version of 971 and later.</p>
OFFANG	Offset angle for AOPT = 3
P4	<p>Material parameter:</p> <p>HARD.EQ.4.0: p in Gosh hardening law</p> <p>HARD.EQ.5.0: q in Hockett-Sherby hardening law</p>
HTFLAG	<p>Heat treatment flag (see remarks):</p> <p>HTFLAG.EQ.0: Preforming stage</p> <p>HTFLAG.EQ.1: Heat treatment stage</p> <p>HTFLAG.EQ.2: Postforming stage</p>
HTA	Load curve/Table ID for postforming parameter A
HTB	Load curve/Table ID for postforming parameter B
HTC	Load curve/Table ID for postforming parameter C
HTD	Load curve/Table ID for postforming parameter D
A1, A2, A3	Components of vector \mathbf{a} for AOPT = 2

VARIABLE	DESCRIPTION
V1, V2, V3	Components of vector \mathbf{v} for AOPT = 3
D1, D2, D3	Components of vector \mathbf{d} for AOPT = 2
USRFAIL	User defined failure flag EQ.0: no user subroutine is called EQ.1: user subroutine matusr_24 in dyn21.f is called

Remarks:

1. Strain rate is accounted for using the Cowper and Symonds model which scales the yield stress with the factor

$$1 + \left(\frac{\dot{\epsilon}}{C}\right)^{1/p}$$

where $\dot{\epsilon}$ is the strain rate. A fully viscoplastic formulation is optional which incorporates the Cowper and Symonds formulation within the yield surface. An additional cost is incurred but the improvement allows for dramatic results. To ignore strain rate effects set both SRC and SRP to zero.

2. The yield condition for this material can be written

$$f(\boldsymbol{\sigma}, \boldsymbol{\alpha}, \varepsilon_p) = \sigma_{\text{eff}}(\sigma_{xx} - 2\alpha_{xx} - \alpha_{yy}, \sigma_{yy} - 2\alpha_{yy} - \alpha_{xx}, \sigma_{xy} - \alpha_{xy}) - \sigma_Y^t(\varepsilon_p, \dot{\epsilon}_p, \beta) \leq 0$$

where

$$\begin{aligned} \sigma_{\text{eff}}(s_{xx}, s_{yy}, s_{xy}) &= \left(\frac{1}{2}(\varphi' + \varphi'')\right)^{1/a} \\ \varphi' &= |X'_1 - X'_2|^a \\ \varphi'' &= |2X''_1 + X''_2|^a + |X''_1 + 2X''_2|^a. \end{aligned}$$

The X'_i and X''_i are eigenvalues of X'_{ij} and X''_{ij} and are given by

$$\begin{aligned} X'_1 &= \frac{1}{2} \left(X'_{11} + X'_{22} + \sqrt{(X'_{11} - X'_{22})^2 + 4X'^2_{12}} \right) \\ X'_2 &= \frac{1}{2} \left(X'_{11} + X'_{22} - \sqrt{(X'_{11} - X'_{22})^2 + 4X'^2_{12}} \right) \end{aligned}$$

and

$$X''_1 = \frac{1}{2} \left(X''_{11} + X''_{22} + \sqrt{(X''_{11} - X''_{22})^2 + 4X''^2_{12}} \right)$$

$$X''_2 = \frac{1}{2} \left(X''_{11} + X''_{22} - \sqrt{(X''_{11} - X''_{22})^2 + 4X''_{12}^2} \right)$$

respectively. The X'_{ij} and X''_{ij} are given by

$$\begin{pmatrix} X'_{11} \\ X'_{22} \\ X'_{12} \end{pmatrix} = \begin{pmatrix} L'_{11} & L'_{12} & 0 \\ L'_{21} & L'_{22} & 0 \\ 0 & 0 & L'_{33} \end{pmatrix} \begin{pmatrix} s_{xx} \\ s_{yy} \\ s_{xy} \end{pmatrix}$$

$$\begin{pmatrix} X''_{11} \\ X''_{22} \\ X''_{12} \end{pmatrix} = \begin{pmatrix} L''_{11} & L''_{12} & 0 \\ L''_{21} & L''_{22} & 0 \\ 0 & 0 & L''_{33} \end{pmatrix} \begin{pmatrix} s_{xx} \\ s_{yy} \\ s_{xy} \end{pmatrix}$$

Where,

$$\begin{pmatrix} L'_{11} \\ L'_{12} \\ L'_{21} \\ L'_{22} \\ L'_{33} \end{pmatrix} = \frac{1}{3} \begin{pmatrix} 2 & 0 & 0 \\ -1 & 0 & 0 \\ 0 & -1 & 0 \\ 0 & 2 & 0 \\ 0 & 0 & 3 \end{pmatrix} \begin{pmatrix} \alpha_1 \\ \alpha_2 \\ \alpha_7 \end{pmatrix}$$

$$\begin{pmatrix} L''_{11} \\ L''_{12} \\ L''_{21} \\ L''_{22} \\ L''_{33} \end{pmatrix} = \frac{1}{9} \begin{pmatrix} -2 & 2 & 8 & -2 & 0 \\ 1 & -4 & -4 & 4 & 0 \\ 4 & -4 & -4 & 1 & 0 \\ -2 & 8 & 2 & -2 & 0 \\ 0 & 0 & 0 & 0 & 9 \end{pmatrix} \begin{pmatrix} \alpha_3 \\ \alpha_4 \\ \alpha_5 \\ \alpha_6 \\ \alpha_8 \end{pmatrix}$$

The parameters α_1 to α_8 are the parameters that determines the shape of the yield surface.

The material parameters can be determined from three uniaxial tests and a more general test. From the uniaxial tests the yield stress and R-values are used and from the general test an arbitrary point on the yield surface is used given by the stress components in the material system as

$$\sigma = \begin{pmatrix} \sigma_{xx} \\ \sigma_{yy} \\ \sigma_{xy} \end{pmatrix}$$

together with a tangent of the yield surface in that particular point. For the latter the tangential direction should be determined so that

$$d_{xx}\dot{\epsilon}_{xx}^p + d_{yy}\dot{\epsilon}_{yy}^p + 2d_{xy}\dot{\epsilon}_{xy}^p = 0$$

The biaxial data can be set to zero in the input deck for LS-DYNA to just fit the uniaxial data.

3. A kinematic hardening model is implemented following the works of Chaboche and Roussilier. A back stress α is introduced such that the effective stress is computed as

$$\sigma_{\text{eff}} = \sigma_{\text{eff}}(\sigma_{11} - 2\alpha_{11} - \alpha_{22}, \sigma_{22} - 2\alpha_{22} - \alpha_{11}, \sigma_{12} - \alpha_{12})$$

The back stress is the sum of up to four terms according to

$$\alpha_{ij} = \sum_{k=1}^4 \alpha_{ij}^k$$

and the evolution of each back stress component is as follows

$$\delta \alpha_{ij}^k = C_k \left(a_k \frac{s_{ij}}{\sigma_{\text{eff}}} - \alpha_{ij}^k \right) \delta \varepsilon_p$$

where C_k and a_k are material parameters, s_{ij} is the deviatoric stress tensor, σ_{eff} is the effective stress and ε_p is the effective plastic strain. The yield condition is for this case modified according to

$$f(\sigma, \alpha, \varepsilon_p) = \sigma_{\text{eff}}(\sigma_{xx} - 2\alpha_{xx} - \alpha_{yy}, \sigma_{yy} - 2\alpha_{yy} - \alpha_{xx}, \sigma_{xy} - \alpha_{xy}) - \left\{ \sigma_Y^t(\varepsilon_p, \dot{\varepsilon}_p, 0) - \sum_{k=1}^4 a_k [1 - \exp(-C_k \varepsilon_p)] \right\} \leq 0$$

in order to get the expected stress strain response for uniaxial stress.

4. The Hansel hardening law is the same as in material 113 but is repeated here for the sake of convenience.

The hardening is temperature dependent and therefore this material model must be run either in a coupled thermo-mechanical solution, using prescribed temperatures or using the adiabatic temperature calculation option. Setting the parameter CP to the specific heat C_p of the material activates the adiabatic temperature calculation that calculates the temperature rate from the equation

$$\dot{T} = \frac{\sigma \cdot D^p}{\rho C_p},$$

where $\sigma \cdot D^p$ is the plastically dissipated heat. Using the Kelvin scale is recommended, even though other scales may be used without problems.

The hardening behaviour is described by the following equations. The martensite rate equation is

$$\frac{\partial V_m}{\partial \bar{\varepsilon}^p} = \begin{cases} 0 & \varepsilon < E_{0(\text{mart})} \\ \frac{B}{A} V_m^p \left(\frac{1 - V_m}{V_m} \right)^{(B+1)/B} \frac{[1 - \tanh(C + D \cdot T)]}{2} \exp\left(\frac{Q}{T - T_{A0}}\right) & \bar{\varepsilon}^p \geq E_{0(\text{mart})} \end{cases}$$

where

$\bar{\epsilon}^p$ = effective plastic strain and

T = temperature.

The martensite fraction is integrated from the above rate equation:

$$V_m = \int_0^{\epsilon} \frac{\partial V_m}{\partial \bar{\epsilon}^p} d\bar{\epsilon}^p.$$

It always holds that $0.0 < V_M < 1.0$. The initial martensite content is V_{m0} and must be greater than zero and less than 1.0. Note that V_{M0} is not used during a restart or when initializing the V_m history variable using *INITIAL_STRESS_SHELL.

The yield stress σ_y is

$$\sigma_y = \{B_{HS} - (B_{HS} - A_{HS})\exp(-m[\bar{\epsilon}^p + \epsilon_0]^n)\}(K_1 + K_2T) + \Delta H_{\gamma \rightarrow \alpha'} V_m.$$

The parameters p and B should fulfill the following condition

$$\frac{1+B}{B} < p,$$

if not fulfilled then the martensite rate will approach infinity as V_m approaches zero. Setting the parameter ϵ_0 larger than zero, typical range 0.001-0.02 is recommended. A part from the effective true strain a few additional history variables are output, see below.

History variables that are output for post-processing:

Variable Description

- 24 Yield stress of material at temperature TREF. Useful to evaluate the strength of the material after e.g., a simulated forming operation.
 - 25 Volume fraction martensite, V_m
 - 26 CP.EQ.0.0: Not used
CP.GT.0.0: Temperature from adiabatic temperature calculation.
5. Heat treatment for increasing the formability of prestrained aluminum sheets can be simulated through the use of HTFLAG, where the intention is to run a forming simulation in steps involving preforming, springback, heat treatment and postforming. In each step the history is transferred to the next via the use of dynain (see *INTERFACE_SPRINGBACK). The first two steps are performed with HTFLAG = 0 according to standard procedures, resulting in a plastic strain field ϵ_p^0 corresponding to the prestrain. The heat treatment step is performed using HTFLAG = 1 in a coupled thermomechanical simulation, where the blank is heated. The coupling between thermal and mechanical is only that the maximum temperature T^0 is stored as a history variable in the material model, this corresponding to the heat treatment temperature. Here it is important to export all

history variables to the dynein file for the postforming step. In the final postforming step, HTFLAG = 2, the yield stress is then augmented by the Hockett-Sherby like term

$$\Delta\sigma = b - (b - a)\exp\left[-c(\varepsilon_p - \varepsilon_p^0)^d\right]$$

where a , b , c and d are given as tables as functions of the heat treatment temperature T^0 and prestrain ε_p^0 . That is, in the table definitions each load curve corresponds to a given prestrain and the load curve value is with respect to the heat treatment temperature,

$$a = a(T^0, \varepsilon_p^0) \quad b = b(T^0, \varepsilon_p^0) \quad c = c(T^0, \varepsilon_p^0) \quad d = d(T^0, \varepsilon_p^0)$$

The effect of heat treatment is that the material strength decreases but hardening increases, thus typically,

$$a \leq 0, \quad b \geq a, \quad c > 0, \quad d > 0.$$

***MAT_VISCOELASTIC_FABRIC**

This is Material Type 134. The viscoelastic fabric model is a variation on the general viscoelastic model of material 76. This model is valid for 3 and 4 node membrane elements only and is strongly recommended for modeling isotropic viscoelastic fabrics where wrinkling may be a problem. For thin fabrics, buckling can result in an inability to support compressive stresses; thus, a flag is included for this option. If bending stresses are important use a shell formulation with model 76.

Card 1	1	2	3	4	5	6	7	8
Variable	MID	RO	BULK				CSE	
Type	I	F	F				F	

If fitting is done from a relaxation curve, specify fitting parameters on card 2, *otherwise* if constants are set on Viscoelastic Constant Cards *LEAVE THIS CARD BLANK*.

Card 2	1	2	3	4	5	6	7	8
Variable	LCID	NT	BSTART	TRAMP	LCIDK	NTK	BSTARTK	TRAMPK
Type	F	I	F	F	F	I	F	F

Viscoelastic Constant Cards. Up to 6 cards may be input. A keyword card (with a "*" in column 1) terminates this input if less than 6 cards are used. These cards are not needed if relaxation data is defined. The number of terms for the shear behavior may differ from that for the bulk behavior: simply insert zero if a term is not included.

Card 3	1	2	3	4	5	6	7	8
Variable	GI	BETAI	KI	BETAKI				
Type	F	F	F	F				

VARIABLE**DESCRIPTION**

MID	Material identification. A unique number must be specified.
RO	Mass density.

VARIABLE	DESCRIPTION
BULK	Elastic constant bulk modulus. If the bulk behavior is viscoelastic, then this modulus is used in determining the contact interface stiffness only.
CSE	Compressive stress flag (default = 0.0). EQ.0.0: don't eliminate compressive stresses EQ.1.0: eliminate compressive stresses
LCID	Load curve ID if constants, G_i , and β_i are determined via a least squares fit. This relaxation curve is shown below.
NT	Number of terms in shear fit. If zero the default is 6. Currently, the maximum number is set to 6.
BSTART	In the fit, β_1 is set to zero, β_2 is set to BSTART, β_3 is 10 times β_2 , β_4 is 10 times β_3 , and so on. If zero, BSTART = 0.01.
TRAMP	Optional ramp time for loading.
LCIDK	Load curve ID for bulk behavior if constants, K_i , and $\beta\kappa_i$ are determined via a least squares fit. This relaxation curve is shown below.
NTK	Number of terms desired in bulk fit. If zero the default is 6. Currently, the maximum number is set to 6.
BSTARTK	In the fit, $\beta\kappa_1$ is set to zero, $\beta\kappa_2$ is set to BSTARTK, $\beta\kappa_3$ is 10 times $\beta\kappa_2$, $\beta\kappa_4$ is 10 times $\beta\kappa_3$, and so on. If zero, BSTARTK = 0.01.
TRAMPK	Optional ramp time for bulk loading.
GI	Optional shear relaxation modulus for the ith term
BETAI	Optional shear decay constant for the ith term
KI	Optional bulk relaxation modulus for the ith term
BETAKI	Optional bulk decay constant for the ith term

Remarks:

Rate effects are taken into account through linear viscoelasticity by a convolution integral of the form:

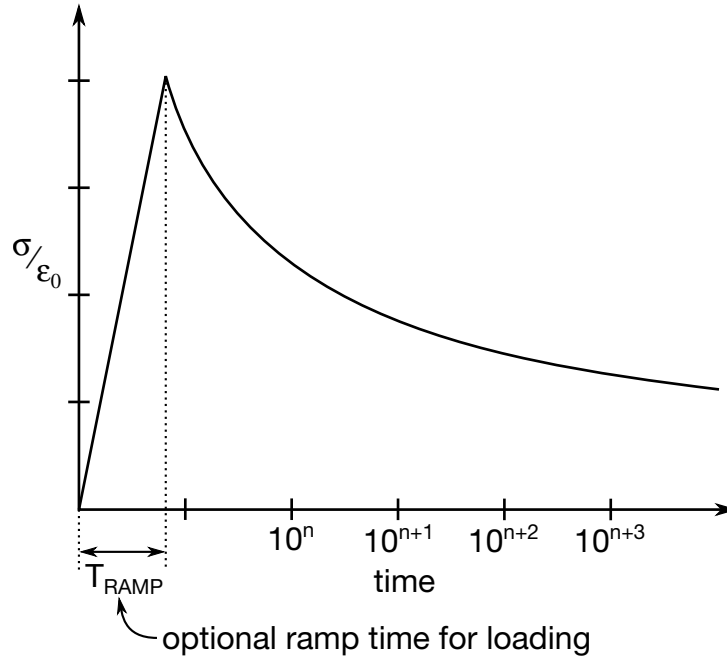

Figure 2-73. Stress Relaxation curve.

$$\sigma_{ij} = \int_0^t g_{ijkl}(t - \tau) \frac{\partial \varepsilon_{kl}}{\partial \tau} d\tau$$

where $g_{ijkl}(t - \tau)$ is the relaxation function. If we wish to include only simple rate effects for the deviatoric stresses, the relaxation function is represented by six terms from the Prony series:

$$g(t) = \sum_{m=1}^N G_m e^{-\beta_m t}$$

We characterize this in the input by shear moduli, G_i , and decay constants, β_i . An arbitrary number of terms, up to 6, may be used when applying the viscoelastic model.

For volumetric relaxation, the relaxation function is also represented by the Prony series in terms of bulk moduli:

$$k(t) = \sum_{m=1}^N K_m e^{-\beta_{k_m} t}$$

For an example of a stress relaxation curve see [Figure 2-73](#). This curve defines stress versus time where time is defined on a logarithmic scale. For best results, the points defined in the load curve should be equally spaced on the logarithmic scale. Furthermore, the load curve should be smooth and defined in the positive quadrant. If nonphysical values are determined by least squares fit, LS-DYNA will terminate with an error message after the initialization phase is completed. If the ramp time for loading is included, then the relaxation which occurs during the loading phase is taken into account. This effect may or may not be important.

***MAT_WTM_STM**

This is material type 135. This anisotropic-viscoplastic material model adopts two yield criteria for metals with orthotropic anisotropy proposed by Barlat and Lian [1989] (Weak Texture Model) and Aretz [2004] (Strong Texture Model).

Card 1	1	2	3	4	5	6	7	8
Variable	MID	R0	E	PR	NUMFI	EPSC	WC	TAUC
Type	A8	F	F	F	F	F	F	F

Card 2	1	2	3	4	5	6	7	8
Variable	SIGMA0	QR1	CR1	QR2	CR2	K	LC	FLG
Type	F	F	F	F	F	F	F	F

YLD2003 Card. This card 3 format is used when FLG = 0.

Card 3	1	2	3	4	5	6	7	8
Variable	A1	A2	A3	A4	A5	A6	A7	A8
Type	F	F	F	F	F	F	F	F

Yield Surface Card. This card 3 format is used when FLG = 1.

Card 3	1	2	3	4	5	6	7	8
Variable	S00	S45	S90	SBB	R00	R45	R90	RBB
Type	F	F	F	F	F	F	F	F

YLD89 Card. This card 3 format used when FLG = 2.

Card 3	1	2	3	4	5	6	7	8
Variable	A	C	H	P				
Type	F	F	F	F				

Card 4	1	2	3	4	5	6	7	8
Variable	QX1	CX1	QX2	CX2	EDOT	M	EMIN	S100
Type	F	F	F	F	F	F	F	F

Card 5	1	2	3	4	5	6	7	8
Variable	AOPT	BETA						
Type	F	F						

Card 6	1	2	3	4	5	6	7	8
Variable	XP	YP	ZP	A1	A2	A3		
Type	F	F	F	F	F	F		

Card 7	1	2	3	4	5	6	7	8
Variable	V1	V2	V3	D1	D2	D3		
Type	F	F	F	F	F	F		

VARIABLE**DESCRIPTION**

MID

Material identification. A unique number or label not exceeding 8 characters must be specified.

VARIABLE	DESCRIPTION
RO	Mass density
E	Young's modulus
PR	Poisson's ratio
NUMFI	Number of through thickness integration points that must fail before the element is deleted (remember to change this number if switching between full and reduced integration type of elements).
EPSC	Critical value ε_{tC} of the plastic thickness strain (used in the CTS fracture criterion).
WC	Critical value W_c for the Cockcroft-Latham fracture criterion
TAUC	Critical value τ_c for the Bressan-Williams shear fracture criterion
SIGMA0	Initial mean value of yield stress σ_0
QR1	Isotropic hardening parameter Q_{R1}
CR1	Isotropic hardening parameter C_{R1}
QR2	Isotropic hardening parameter Q_{R2}
CR2	Isotropic hardening parameter C_{R2}
K	k equals half YLD2003 exponent m . Recommended value for FCC materials is $m = 8$, i.e. $k = 4$.
LC	First load curve number for process effects, i.e. the load curve describing the relation between the pre-strain and the yield stress σ_0 . Similar curves for Q_{R1} , C_{R1} , Q_{R2} , C_{R2} , and W_c must follow consecutively from this number.
A1	Yld2003 parameter a_1
A2	Yld2003 parameter a_2
A3	Yld2003 parameter a_3
A4	Yld2003 parameter a_4
A5	Yld2003 parameter a_5
A6	Yld2003 parameter a_6

VARIABLE	DESCRIPTION
A7	Yld2003 parameter a_7
A8	Yld2003 parameter a_8
S00	Yield stress in 0° direction
S45	Yield stress in 45° direction
S90	Yield stress in 90° direction
SBB	Balanced biaxial flow stress
R00	R-ratio in 0° direction
R45	R-ratio in 45° direction
R90	R-ratio in 90° direction
RBB	Balance biaxial flow ratio
A	YLD89 parameter a
C	YLD89 parameter c
H	YLD89 parameter h
P	YLD89 parameter p
QX1	Kinematic hardening parameter Q_{x1}
CX1	Kinematic hardening parameter C_{x1}
QX2	Kinematic hardening parameter Q_{x2}
CX2	Kinematic hardening parameter C_{x2}
EDOT	Strain rate parameter $\dot{\epsilon}_0$
M	Strain rate parameter m

VARIABLE	DESCRIPTION
EMIN	<p>Lower limit of the isotropic hardening rate $\frac{dR}{d\bar{\epsilon}}$. This feature is included to model a non-zero and linear/exponential isotropic work hardening rate at large values of effective plastic strain. If the isotropic work hardening rate predicted by the utilized Voce-type work hardening rule falls below the specified value it is substituted by the prescribed value or switched to a power-law hardening if S100.NE.0. This option should be considered for problems involving extensive plastic deformations. If process dependent material characteristics are prescribed, i.e. if LC .GT. 0 the same minimum tangent modulus is assumed for all the prescribed work hardening curves. If instead EMIN.LT.0 then -EMIN defines the plastic strain value at which the linear or power-law hardening approximation commences.</p>
S100	<p>Yield stress at 100% strain for using a power-law approximation beyond the strain defined by EMIN.</p>
AOPT	<p>Material axes option (see MAT_OPTIONTROPIC_ELASTIC for a more complete description):</p> <p>EQ.0.0: locally orthotropic with material axes determined by element nodes 1, 2, and 4, as with *DEFINE_COORDINATE_NODES, and then rotated about the shell element normal by an angle BETA.</p> <p>EQ.2.0: globally orthotropic with material axes determined by vectors defined below, as with *DEFINE_COORDINATE_VECTOR.</p> <p>EQ.3.0: locally orthotropic material axes determined by rotating the material axes about the element normal by an angle, BETA, from a line in the plane of the element defined by the cross product of the vector v with the element normal.</p> <p>LT.0.0: the absolute value of AOPT is a coordinate system ID number (CID on *DEFINE_COORDINATE_NODES, *DEFINE_COORDINATE_SYSTEM or *DEFINE_COORDINATE_VECTOR). Available in R3 version of 971 and later..</p>
BETA	<p>Material angle in degrees for AOPT = 0 or 3, may be overwritten on the element card, see *ELEMENT_SHELL_BETA.</p>
XP YP ZP	<p>Coordinates of point p for AOPT = 1.</p>

VARIABLE	DESCRIPTION
A1 A2 A3	Components of vector a for AOPT = 2.
V1 V2 V3	Components of vector v for AOPT = 3
D1 D2 D3	Components of vector d for AOPT = 2.

Remarks:

If FLG = 1, i.e. if the yield surface parameters a_1 - a_8 are identified on the basis of prescribed material data internally in the material routine, files with point data for plotting of the identified yield surface, along with the predicted directional variation of the yield stress and plastic flow are generated in the directory where the LS-DYNA analysis is run. Four different files are generated for each specified material.

These files are named according to the scheme:

1. Contour_1#
2. Contour_2#
3. Contour_3#
4. R_and_S#

Where # is a value starting at 1.

The three first files contain contour data for plotting of the yield surface as shown in [Figure 2-75](#). To generate these plots a suitable plotting program should be adopted and for each file/plot, column A should be plotted vs. columns B. For a more detailed description of these plots it is referred to References. [Figure 2-76](#) further shows a plot generated from the final file named 'R_and_S#' showing the directional dependency of the normalized yield stress (column A vs. B) and plastic strain ratio (column B vs. C).

The yield condition for this material can be written

$$t(\boldsymbol{\sigma}, \boldsymbol{\alpha}, \varepsilon^p, \dot{\varepsilon}^p) = \sigma_{\text{eff}}(\boldsymbol{\sigma}, \boldsymbol{\alpha}) - \sigma_Y(\varepsilon^p, \dot{\varepsilon}^p)$$

where

$$\sigma_Y = [\sigma_0 + R(\varepsilon^p)] \left(1 + \frac{\dot{\varepsilon}^p}{\dot{\varepsilon}_0}\right)^C$$

where the isotropic hardening reads

$$R(\varepsilon^p) = Q_{R1}[1 - \exp(-C_{R1}\varepsilon^p)] + Q_{R2}[1 - \exp(-C_{R2}\varepsilon^p)].$$

For the Weak Texture Model the yield function is defined as

$$\sigma_{\text{eff}} = \left[\frac{1}{2} \{ a(k_1 + k_2)^m + a(k_1 - k_2)^m + C(2k_2)^m \} \right]^{\frac{1}{m}}$$

where

$$k_1 = \frac{\sigma_x + h \sigma_y}{2}$$

$$k_2 = \sqrt{\left(\frac{\sigma_x + h \sigma_y}{2} \right)^2 + (r \sigma_{xy})^2}$$

For the Strong Texture Model the yield function is defined as

$$\sigma_{\text{eff}} = \left\{ \frac{1}{2} [(\sigma'_+)^m + (\sigma'_-)^m + (\sigma''_+ - \sigma''_-)^m] \right\}^{\frac{1}{m}}$$

where

$$\sigma'_{\pm} = \frac{a_8 \sigma_x + a_1 \sigma_y}{2} \pm \sqrt{\left(\frac{a_2 \sigma_x - a_3 \sigma_y}{2} \right)^2 + a_4^2 \sigma_{xy}^2}$$

$$\sigma''_{\pm} = \frac{\sigma_x + \sigma_y}{2} \pm \sqrt{\left(\frac{a_5 \sigma_x - a_6 \sigma_y}{2} \right)^2 + a_7^2 \sigma_{xy}}$$

Kinematic hardening can be included by

$$\alpha = \sum_{R=1}^2 \alpha_R$$

where each of the kinematic hardening variables α_R is independent and obeys a nonlinear evolutionary equation in the form

$$\dot{\alpha}_R = C_{\alpha i} \left(Q_{\alpha i} \frac{\tau}{\sigma} - \alpha_R \right) \dot{\epsilon}^p$$

where the effective stress $\bar{\sigma}$ is defined as

$$\bar{\sigma} = \sigma_{\text{eff}}(\tau)$$

where

$$\tau = \sigma - \alpha.$$

Critical thickness strain failure in a layer is assumed to occur when

$$\epsilon_t \leq \epsilon_{tc}$$

where ϵ_{tc} is a material parameter. It should be noted that ϵ_{tc} is a negative number (i.e. failure is assumed to occur only in the case of thinning).

Cockcraft and Latham fracture is assumed to occur when

$$W = \int \max(\sigma_1, 0) d\epsilon^p \geq W_C$$

where σ_1 is the maximum principal stress and W_C is a material parameter.

<i>History Variable</i>	<i>Description</i>
1	Isotropic hardening value R_1
2	Isotropic hardening value R_2
3	Increment in effective plastic strain $\Delta\bar{\epsilon}$
4	Not defined, for internal use in the material model
5	Not defined, for internal use in the material model
6	Not defined, for internal use in the material model
7	Failure in integration point EQ.0: No failure EQ.1: Failure due to EPSC, i.e. $\epsilon_t \geq \epsilon_{tc}$. EQ.2: Failure due to WC, i.e. $W \geq W_C$. EQ.3: Failure due to TAUC, i.e. $\tau \geq \tau_c$
8	Sum of incremental strain in local element x-direction: $\epsilon_{xx} = \sum \Delta\epsilon_{xx}$
9	Sum of incremental strain in local element y-direction: $\epsilon_{yy} = \sum \Delta\epsilon_{yy}$
10	Value of theh Cockcroft-Latham failure parameter $W = \sum \sigma_1 \Delta p$
11	Plastic strain component in thickness direction ϵ_t
12	Mean value of increments in plastic strain through the thickness (For use with the non-local instability criterion. Note that constant lamella thickness is assumed and the instability criterion can give unrealistic results if used with a user-defined integration rule with varying lamella thickness.)
13	Not defined, for internal use in the material model
14	Nonlocal value $\rho = \frac{\Delta\epsilon_3}{\Delta\epsilon_3^\Omega}$

Table 2-74.

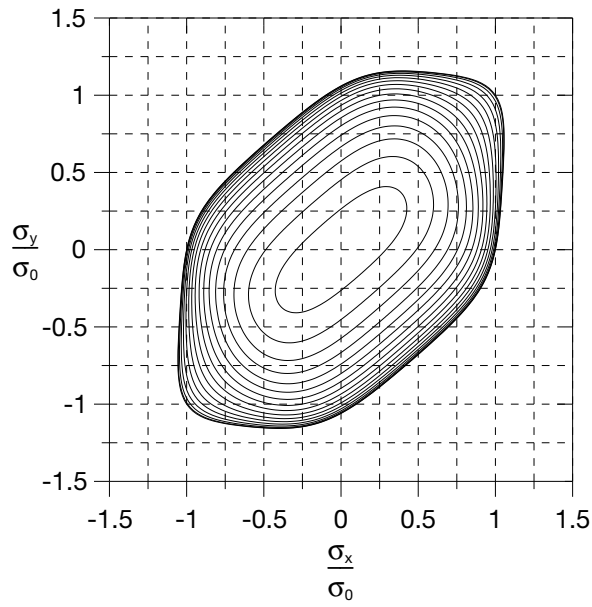

(A)

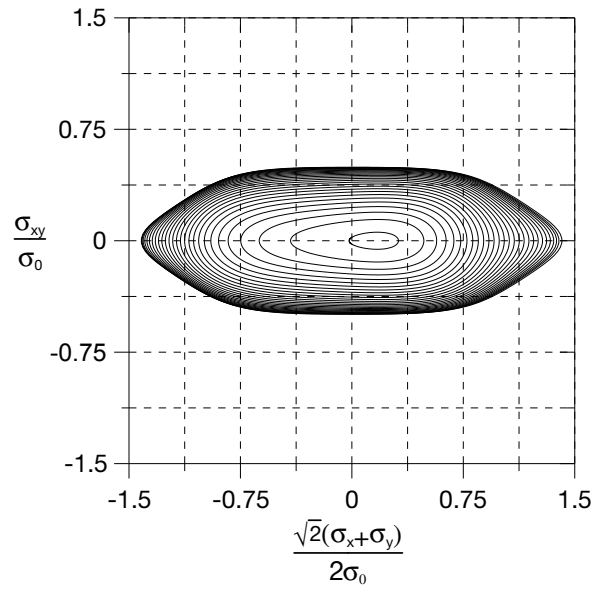

(B)

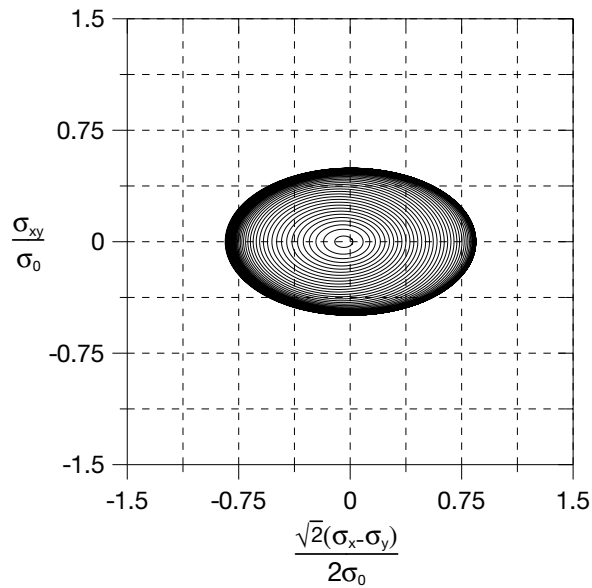

(C)

Figure 2-75. Contour plots of the yield surface generated from the files (a) 'Contour_1<#>', (b) Contour_2<#>', and (c) 'Contour_3<#>'.

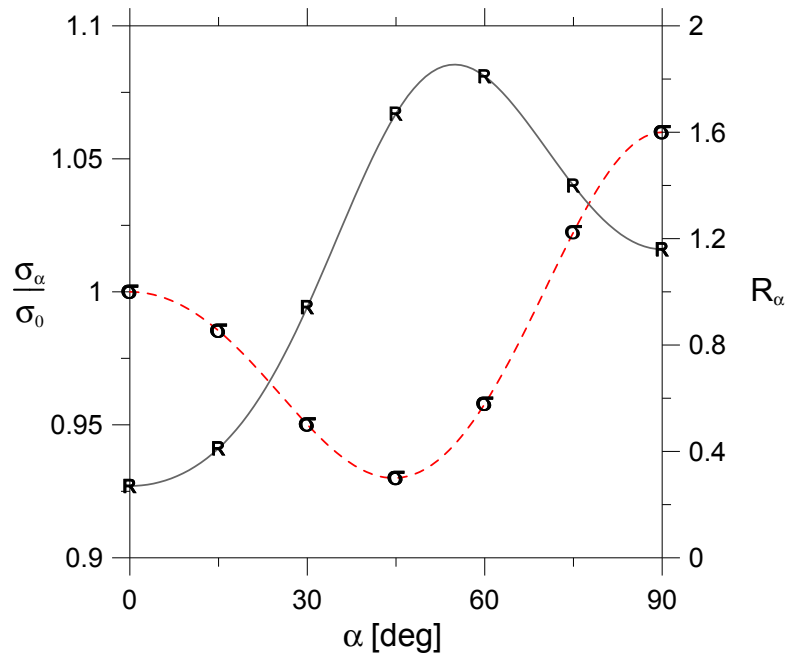

Figure 2-76. Predicted directional variation of the yield stress and plastic flow generated from the file 'R_and_S<#>'.

***MAT_WTM_STM_PLC**

This is Material Type 135. This anisotropic material adopts the yield criteria proposed by Aretz [2004]. The material strength is defined by McCormick's constitutive relation for materials exhibiting negative steady-state Strain Rate Sensitivity (SRS). McCormick [1998] and Zhang, McCormick and Estrin [2001].

Card 1	1	2	3	4	5	6	7	8
Variable	MID	RO	E	PR	NUMFI	EPSC	WC	TAUC
Type	A8	F	F	F	F	F	F	F

Card 2	1	2	3	4	5	6	7	8
Variable	SIGMA0	QR1	CR1	QR2	CR2	K		
Type	F	F	F	F	F	F		

Card 3	1	2	3	4	5	6	7	8
Variable	A1	A2	A3	A4	A5	A6	A7	A8
Type	F	F	F	F	F	F	F	F

Card 4	1	2	3	4	5	6	7	8
Variable	S	H	OMEGA	TD	ALPHA	EPS0		
Type	F	F	F	F	F	F		

Card 5	1	2	3	4	5	6	7	8
Variable	AOPT	BETA						
Type	F	F						

Card 6	1	2	3	4	5	6	7	8
Variable	XP	YP	ZP	A1	A2	A3		
Type	F	F	F	F	F	F		

Card 7	1	2	3	4	5	6	7	8
Variable	V1	V2	V3	D1	D2	D3		
Type	F	F	F	F	F	F		

VARIABLE**DESCRIPTION**

MID	Material identification. A unique number or label not exceeding 8 characters must be specified.
RO	Mass density
E	Young's modulus
PR	Poisson's ratio
NUMFI	Number of through thickness integration points that must fail before the element is deleted (remember to change this number if switching between full and reduced integration type of elements).
EPSC	Critical value ϵ_{tC} of the plastic thickness strain.
WC	Critical value W_c for the Cockcroft-Latham fracture criterion.
TAUC	Critical value τ_c for the shear fracture criterion.
SIGMA0	Initial yield stress σ_0

VARIABLE	DESCRIPTION
QR1	Isotropic hardening parameter, Q_{R1}
CR1	Isotropic hardening parameter, C_{R1}
QR2	Isotropic hardening parameter, Q_{R2}
CR2	Isotropic hardening parameter, C_{R2}
K	k equals half the exponent m for the yield criterion
A1	Yld2003 parameter, a_1
A2	Yld2003 parameter, a_2
A3	Yld2003 parameter, a_3
A4	Yld2003 parameter, a_4
A5	Yld2003 parameter, a_5
A6	Yld2003 parameter, a_6
A7	Yld2003 parameter, a_7
A8	Yld2003 parameter, a_8
S	Dynamic strain aging parameter, S .
H	Dynamic strain aging parameter, H .
OMEGA	Dynamic strain aging parameter, Ω .
TD	Dynamic strain aging parameter, t_d .
ALPHA	Dynamic strain aging parameter, α .
EPS0	Dynamic strain aging parameter, $\dot{\epsilon}_0$.
AOPT	Material axes option (see Mat_OPTION TROPIC_ELASTIC for a more complete description) <p>EQ.0.0: Locally orthotropic with material axes determined by element nodes as shown in Figure 2-3, and then rotated about the shell element normal by the angle BETA. Nodes 1, 2 and 4 of an element are identical to the nodes used for the definition of a coordinate system as by *DEFINE_COORDINATE_NODES.</p>

VARIABLE	DESCRIPTION
	EQ.2.0: Globally orthotropic with material axes determined by vectors defined below, as with *DEFINE_COORDINATE_VECTOR.
	EQ.3.0: Locally orthotropic material axes determined by offsetting the material axes by an angle, BETA, from a line determined by taking the cross product of the vector \mathbf{v} with the normal to the plane of the element.
	LT.0.0: the absolute value of AOPT is a coordinate system ID number (CID on *DEFINE_COORDINATE_NODES, *DEFINE_COORDINATE_SYSTEM or *DEFINE_COORDINATE_VECTOR). Available in R3 version of 971 and later.
BETA	Material angle in degrees for AOPT = 0 and 3, may be overwritten on the element card, see *ELEMENT_SHELL_BETA.
XP, YP, ZP	Coordinates of point \mathbf{p} for AOPT = 1.
A1, A2, A3	Components of vector \mathbf{a} for AOPT = 2.
V1, V2, V3	Components of vector \mathbf{v} for AOPT = 3.
D1, D2, D3	Components of vector \mathbf{d} for AOPT = 2.

Remarks:

The yield function is defined as

$$f = \bar{f}(\boldsymbol{\sigma}) - [\sigma_Y(t_a) + R(\varepsilon_p) + \sigma_v(\dot{\varepsilon}^p)]$$

where the equivalent stress σ_{eq} is defined as by an anisotropic yield criterion

$$\sigma_{eq} = \left[\frac{1}{2} (|\sigma'_1|^m + |\sigma'_2|^m + |\sigma''_1 - \sigma''_2|) \right]^{\frac{1}{m}}$$

where

$$\begin{Bmatrix} \sigma'_1 \\ \sigma'_2 \end{Bmatrix} = \frac{a_8\sigma_{xx} + a_1\sigma_{yy}}{2} \pm \sqrt{\left(\frac{a_2\sigma_{xx} - a_3\sigma_{yy}}{2}\right)^2 + a_4^2\sigma_{xy}^2}$$

and

$$\begin{Bmatrix} \sigma''_1 \\ \sigma''_2 \end{Bmatrix} = \frac{\sigma_{xx} + \sigma_{yy}}{2} \pm \sqrt{\left(\frac{a_5\sigma_{xx} - a_6\sigma_{yy}}{2}\right)^2 + a_7^2\sigma_{xy}^2}$$

The strain hardening function R is defined by the extended Voce law

$$R(\varepsilon^p) = \sum_{i=1}^2 Q_{Ri} (1 - \exp(-C_{Ri} \varepsilon^p))$$

where ε^p is the effective (or accumulated) plastic strain, and Q_{Ri} and C_{Ri} are strain hardening parameters.

Viscous stress σ_v is given by

$$\sigma_v = (S \dot{\varepsilon}^p) = s \ln \left(1 + \frac{\dot{\varepsilon}^p}{\dot{\varepsilon}_0} \right)$$

where S represents the instantaneous strain rate sensitivity (SRS) and $\dot{\varepsilon}_0$ is a reference strain rate. In this model the yield strength, including the contribution from dynamic strain aging (DSA) is defined as

$$\sigma_Y(t_a) = \sigma_0 + SH \left[1 - \exp \left\{ - \left(\frac{t_a}{t_d} \right)^\alpha \right\} \right]$$

where σ_0 is the yield strength for vanishing average waiting time, t_a , i.e. at high strain rates, and H , α and t_d are material constants linked to dynamic strain aging. It is noteworthy that σ_Y is an increasing function of t_a . The average waiting time is defined by the evolution equation

$$\dot{t}_a = 1 - \frac{t_a}{t_{a,ss}}$$

where the quasi-steady waiting time $t_{a,ss}$ is given as

$$t_{a,ss} = \frac{\Omega}{\dot{\varepsilon}^p}$$

where Ω is the strain produced by all mobile dislocations moving to the next obstacle on their path.

***MAT_CORUS_VEGTER**

This is Material Type 136, a plane stress orthotropic material model for metal forming. Yield surface construction is based on the interpolation by second-order Bezier curves, and model parameters are determined directly from a set of mechanical tests conducted for a number of directions. For each direction, four mechanical tests are carried out: a uniaxial, an equi-biaxial, a plane strain tensile test and a shear test. These test results are used to determine the coefficients of the Fourier directional dependency field. For a more detailed description please see Vegter and Boogaard [2006].

Card 1	1	2	3	4	5	6	7	8
Variable	MID	R0	E	PR	N	FBI	RBIO	LCID
Type	A8	F	F	F	F	F	F	F

Card 2	1	2	3	4	5	6	7	8
Variable	SYS	SIP	SHS	SHL	ESH	E0	ALPHA	LCID2
Type	F	F	F	F	F	F	F	F

Card 3	1	2	3	4	5	6	7	8
Variable	AOPT							
Type								

Card 4	1	2	3	4	5	6	7	8
Variable	XP	YP	ZP	A1	A2	A3		
Type	F	F	F	F	F	F		

Card 5	1	2	3	4	5	6	7	8
Variable	V1	V2	V3	D1	D2	D3	BETA	
Type	F	F	F	F	F	F	F	

Experimental Data Cards. The next N cards (see N, card 1) contain experimental data obtained from four mechanical tests for a group of equidistantly placed directions $\theta_i = \frac{i\pi}{2N}$ ($i = 0, 1, 2, \dots, N$)

Card 6	1	2	3	4	5	6	7	8
Variable	FUN-I	RUN-I	FPS1-I	FPS2-I	FSH-I			
Type	F	F	F	F	F			

VARIABLE**DESCRIPTION**

MID	Material identification. A unique number or label not exceeding 8 characters must be specified.
RO	Material density
E	Elastic Young's modulus
PR	Poisson's ratio
N	Order of Fourier series (i.e., number of test groups minus one). The minimum number for N is 2, and the maximum is 12.
FBI	Normalized yield stress σ_{bi} for equi-biaxial test.
RBI0	Strain ratio $\rho_{bi}(0^\circ) = \dot{\epsilon}_2(0^\circ)/\dot{\epsilon}_1(0^\circ)$ for equi-biaxial test in the rolling direction.
LCID	Stress-strain curve ID. If defined, SYS, SIP, SHS, SHL, ESH, and E0 are ignored.
SYS	Static yield stress, σ_0 .
SIP	Stress increment parameter, $\Delta\sigma_m$.
SHS	Strain hardening parameter for small strain, β .

VARIABLE	DESCRIPTION
SHL	Strain hardening parameter for larger strain, Ω .
ESH	Exponent for strain hardening, n .
E0	Initial plastic strain, ϵ_0
ALPHA	α distribution of hardening used in the curve-fitting. $\alpha = 0$ pure kinematic hardening and $\alpha = 1$ provides pure isotropic hardening.
LCID2	Curve ID. The curve defines Young's modulus scaling factor with respect to the plastic strain. By default it is assumed that Young's modulus remains constant. Effective value is between 0 and 1.
AOPT	Material axes option (see MAT_OPTIONTROPIC_ELASTIC for a more complete description): <p>EQ.0.0: locally orthotropic with material axes determined by element nodes 1, 2, and 4, as with *DEFINE_COORDINATE_NODES, and then rotated about the shell element normal by the angle BETA.</p> <p>EQ.2.0: globally orthotropic with material axes determined by vectors defined below, as with *DEFINE_COORDINATE_VECTOR.</p> <p>EQ.3.0: locally orthotropic material axes determined by rotating the material axes about the element normal by an angle, BETA, from a line in the plane of the element defined by the cross product of the vector \mathbf{v} with the element normal.</p> <p>LT.0.0: the absolute value of AOPT is a coordinate system ID number (CID on *DEFINE_COORDINATE_NODES, *DEFINE_COORDINATE_SYSTEM or *DEFINE_COORDINATE_VECTOR).</p>
XP, YP, ZP	Coordinates of point \mathbf{p} for AOPT = 1.
A1, A2, A3	Components of vector \mathbf{a} for AOPT = 2.
V1, V2, V3	Components of vector \mathbf{v} for AOPT = 3
D1, D2, D3	Components of vector \mathbf{d} for AOPT = 2.
BETA	Material angle in degrees for AOPT = 0 and 3, may be overwritten on the element card, see *ELEMENT_SHELL_BETA.

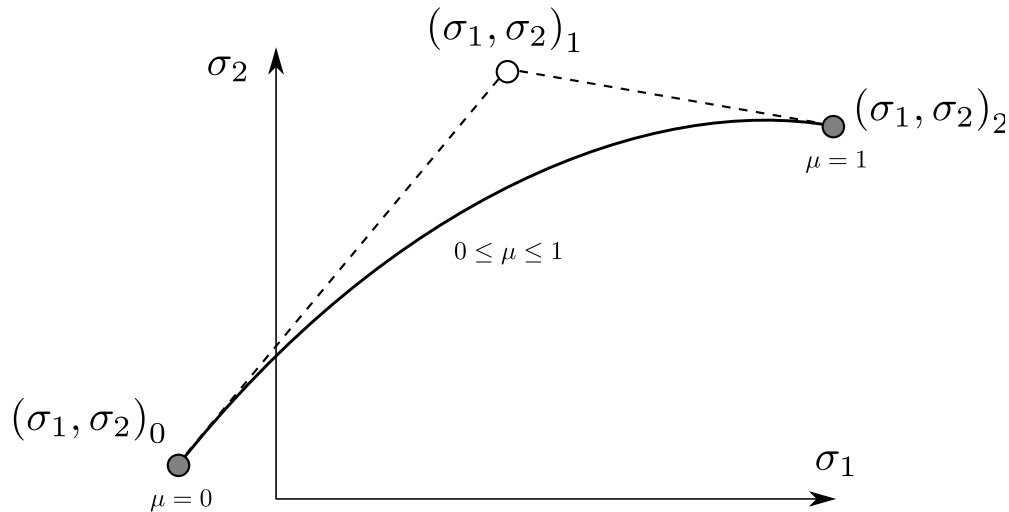

Figure 2-77. Bézier interpolation curve.

VARIABLE	DESCRIPTION
FUN-I	Normalized yield stress σ_{un} for uniaxial test for the <i>i</i> th direction.
RUN-I	Strain ratio (R-value) for uniaxial test for the <i>i</i> th direction.
FPS1-I	First normalized yield stress σ_{ps1} for plain strain test for the <i>i</i> th direction.
FPS2-I	Second normalized yield stress σ_{ps2} for plain strain test for the <i>i</i> th direction.
FSH-I	First normalized yield stress σ_{sh} for pure shear test for the <i>i</i> th direction.

Remarks:

The Vegter yield locus is section-wise defined by quadratic Bézier interpolation functions. Each individual curve uses 2 reference points and a hinge point in the principal plane stress space, see [Figure 2-77](#).

The mathematical description of the Bézier interpolation is given by:

$$\begin{pmatrix} \sigma_1 \\ \sigma_2 \end{pmatrix} = \begin{pmatrix} \sigma_1 \\ \sigma_2 \end{pmatrix}_0 + 2\mu \left[\begin{pmatrix} \sigma_1 \\ \sigma_2 \end{pmatrix}_1 - \begin{pmatrix} \sigma_1 \\ \sigma_2 \end{pmatrix}_0 \right] + \mu^2 \left[\begin{pmatrix} \sigma_1 \\ \sigma_2 \end{pmatrix}_2 + \begin{pmatrix} \sigma_1 \\ \sigma_2 \end{pmatrix}_0 - 2 \begin{pmatrix} \sigma_1 \\ \sigma_2 \end{pmatrix}_1 \right]$$

where $(\sigma_1, \sigma_2)_0$ is the first reference point, $(\sigma_1, \sigma_2)_1$ is the hinge point, and $(\sigma_1, \sigma_2)_2$ is the second reference point. μ is a parameter which determines the location on the curve ($0 \leq \mu \leq 1$).

Four characteristic stress states are selected as reference points: the equi-biaxial point $(\sigma_{bi}, \sigma_{bi})$, the plane strain point $(\sigma_{ps1}, \sigma_{ps2})$, the uniaxial point $(\sigma_{un}, 0)$ and the pure shear point $(\sigma_{sh}, -\sigma_{sh})$, see [Figure 2-78](#). Between the 4 stress points, 3 Bézier curves are used to interpolate the yield locus. Symmetry conditions are used to construct the complete surface. The yield locus in [Figure 2-78](#) shows the reference points of experiments for one specific direction. The reference points can also be determined for other angles to the rolling direction (planar angle θ). E.g. if $N = 2$ is chosen, normalized yield stresses for directions 0° , 45° , and 90° should be defined. A Fourier series is used to interpolate intermediate angles between the measured points.

The Vegter yield function with isotropic hardening (ALPHA = 1) is given as:

$$\phi = \sigma_{eq}(\sigma_1, \sigma_2, \theta) - \sigma_y(\bar{\epsilon}^p)$$

with the equivalent stress σ_{eq} obtained from the appropriate Bézier function related to the current stress state. The uni-axial yield stress σ_y can be defined as stress-strain curve LCID or alternatively as a functional expression:

$$\sigma_y = \sigma_0 + \Delta\sigma_m \left[\beta(\bar{\epsilon}^p + \epsilon_0) + \left(1 - e^{-\Omega(\bar{\epsilon}^p + \epsilon_0)}\right)^n \right]$$

In case of kinematic hardening (ALPHA < 1), the standard stress tensor is replaced by a relative stress tensor, defined as the difference between the stress tensor and a back stress tensor.

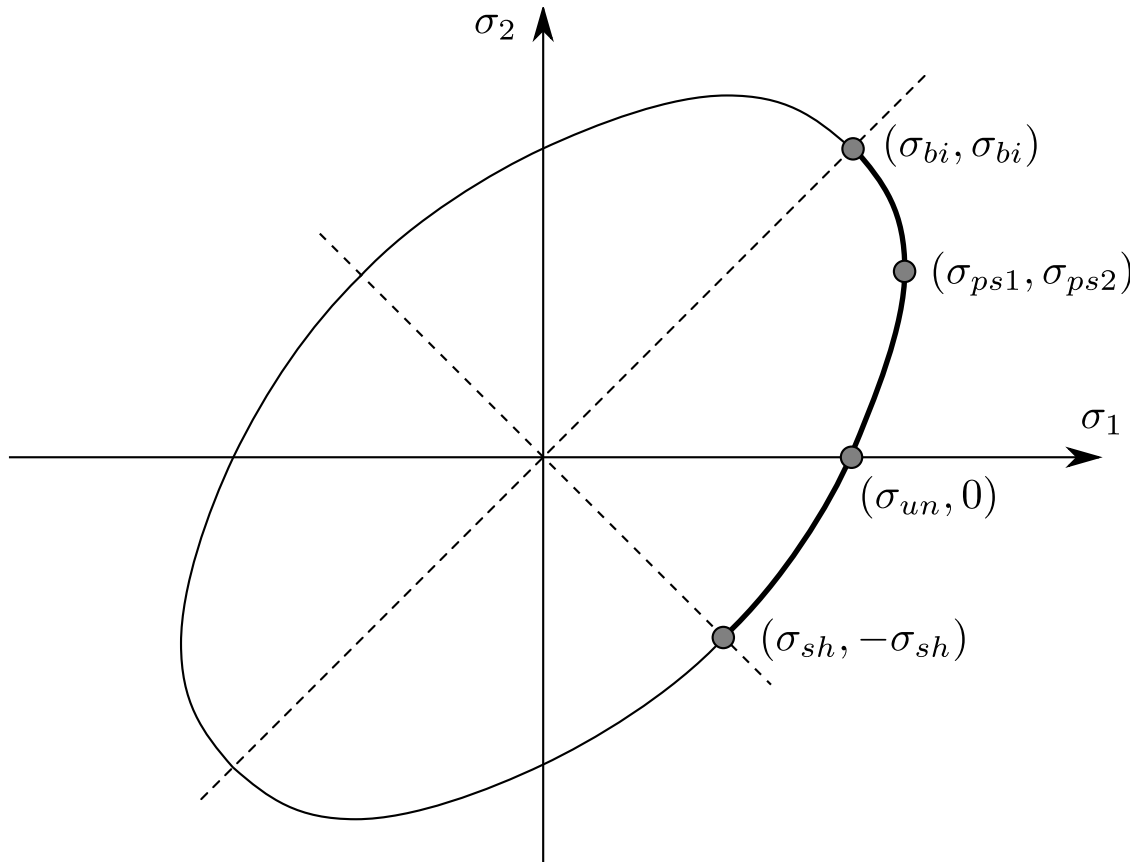

Figure 2-78. Vegter yield surface.

To determine the yield stress or reference points of the Vegter yield locus, four mechanical tests have to be performed for different directions. A good description about the material characterization procedure can be found in Vegter et al. (2003).

***MAT_COHESIVE_MIXED_MODE**

This is Material Type 138. This model is a simplification of *MAT_COHESIVE_GENERAL restricted to linear softening. It includes a bilinear traction-separation law with quadratic mixed mode delamination criterion and a damage formulation. It can be used with solid element types 19 and 20, and is not available for other solid element formulations. See the remarks after *SECTION_SOLID for a description of element types 19 and 20.

Card 1	1	2	3	4	5	6	7	8
Variable	MID	RO	ROFLG	INTFAIL	EN	ET	GIC	GIIC
Type	A8	F	F	F	F	F	F	F

Card 2	1	2	3	4	5	6	7	8
Variable	XMU	T	S	UND	UTD			
Type	F	F	F	F	F			

VARIABLE	DESCRIPTION
MID	Material identification. A unique number or label not exceeding 8 characters must be specified.
RO	Mass density
ROFLG	Flag for whether density is specified per unit area or volume. ROFLG = 0 specified density per unit volume (default), and ROFLG = 1 specifies the density is per unit area for controlling the mass of cohesive elements with an initial volume of zero.
INTFAIL	The number of integration points required for the cohesive element to be deleted. If it is zero, the element won't be deleted even if it satisfies the failure criterion. The value of INTFAIL may range from 1 to 4, with 1 the recommended value.
EN	The stiffness (units of stress/length) normal to the plane of the cohesive element.
ET	The stiffness (units of stress/length)) in the plane of the cohesive element.

VARIABLE	DESCRIPTION
GIC	Energy release rate for mode I (units of stress*length)
GIIC	Energy release rate for mode II (units of stress*length)
XMU	Exponent of the mixed mode criteria (see remarks below)
T	Peak traction (stress units) in normal direction LT.0.0: Load curve ID = (-T) which defines peak traction in normal direction as a function of element size. See remarks.
S	Peak traction (stress units) in tangential direction LT.0.0: Load curve ID = (-S) which defines peak traction in tangential direction as a function of element size. See remarks.
UND	Ultimate displacement in the normal direction
UTD	Ultimate displacement in the tangential direction

Remarks:

The ultimate displacements in the normal and tangential directions are the displacements at the time when the material has failed completely, i.e., the tractions are zero. The linear stiffness for loading followed by the linear softening during the damage provides an especially simple relationship between the energy release rates, the peak tractions, and the ultimate displacements:

$$GIC = T \times \frac{UND}{2}$$

$$GIIC = S \times \frac{UTD}{2}$$

If the peak tractions aren't specified, they are computed from the ultimate displacements. See Fiolka and Matzenmiller [2005] and Gerlach, Fiolka and Matzenmiller [2005].

In this cohesive material model, the total mixed-mode relative displacement δ_m is defined as $\delta_m = \sqrt{\delta_I^2 + \delta_{II}^2}$, where $\delta_I = \delta_3$ is the separation in normal direction (mode I) and $\delta_{II} = \sqrt{\delta_1^2 + \delta_2^2}$ is the separation in tangential direction (mode II). The mixed-mode damage initiation displacement δ^0 (onset of softening) is given by

$$\delta^0 = \delta_I^0 \delta_{II}^0 \sqrt{\frac{1 + \beta^2}{(\delta_{II}^0)^2 + (\beta \delta_I^0)^2}}$$

where $\delta_I^0 = T/EN$ and $\delta_{II}^0 = S/ET$ are the single mode damage initiation separations and $\beta = \delta_{II}/\delta_I$ is the “mode mixity” (see Figure 2-79). The ultimate mixed-mode displacement δ^F (total failure) for the power law ($XMU > 0$) is:

$$\delta^F = \frac{2(1 + \beta)^2}{\delta^0} \left[\left(\frac{EN}{GIC} \right)^{XMU} + \left(\frac{ET \times \beta^2}{GIIC} \right)^{XMU} \right]^{-\frac{1}{XMU}}$$

and alternatively for the Benzeggagh-Kenane law [1996] ($XMU < 0$):

$$\delta^F = \frac{2}{\delta^0 \left(\frac{1}{1 + \beta^2} EN + \frac{\beta^2}{1 + \beta^2} ET \right)} \left[GIC + (GIIC - GIC) \left(\frac{\beta^2 \times ET}{EN + \beta^2 \times ET} \right)^{|XMU|} \right]$$

In this model, damage of the interface is considered, i.e. irreversible conditions are enforced with loading/unloading paths coming from/pointing to the origin.

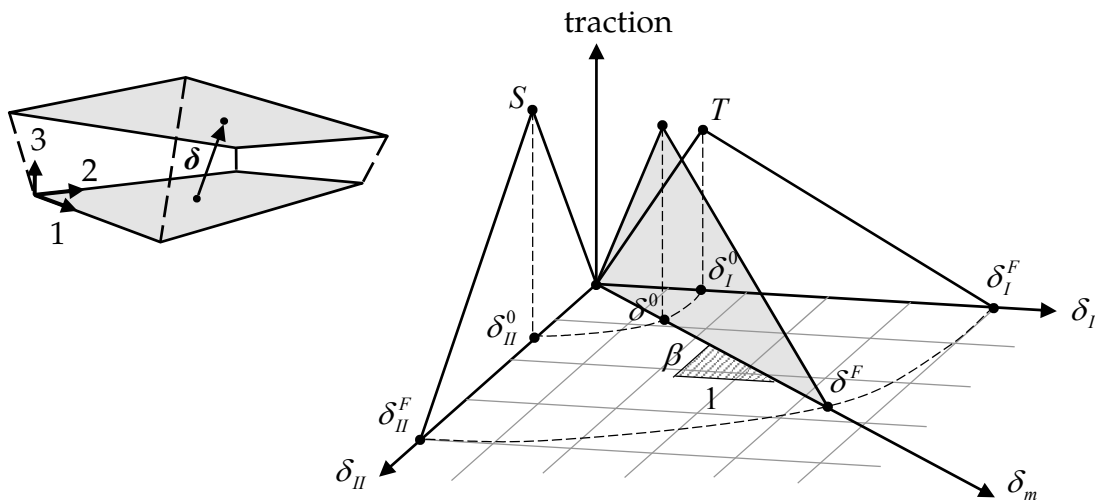

Figure 2-79. Mixed-mode traction-separation law

Peak tractions T and/or S can be defined as functions of characteristic element length (square root of midsurface area) via load curve. This option is useful to get nearly the same global responses (e.g. load-displacement curve) with coarse meshes when compared to a fine mesh solution. In general, lower peak traction values are needed for coarser meshes

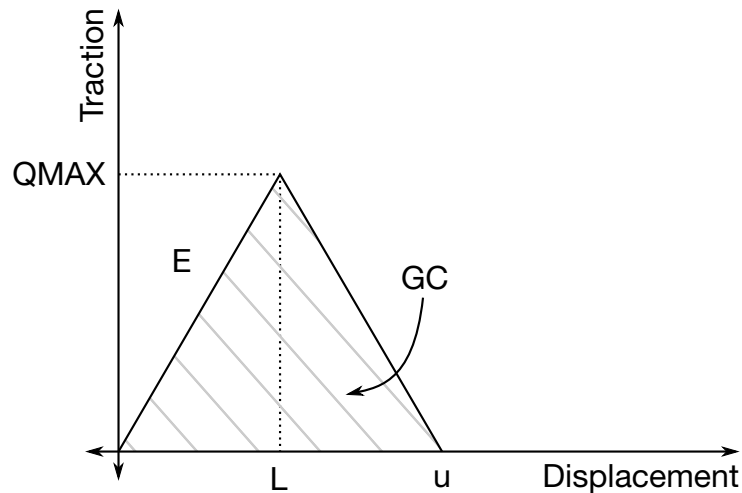

Figure 2-80. Bilinear traction-separation

Two error checks have been implemented for this material model in order to ensure proper material data. Since the traction versus displacement curve is fairly simple (triangular shaped), equations can be developed to ensure that the displacement (L) at the peak load (Q_{MAX}), is smaller than the ultimate distance for failure (u). See [Figure 2-80](#) for the used notation.

One has that

$$GC = \frac{1}{2} u \times Q_{MAX}$$

And,

$$L = \frac{Q_{MAX}}{E}.$$

To ensure that the peak is not past the failure point, $\frac{u}{L}$ must be larger than 1.

$$u = \frac{2GC}{EL},$$

where GC is the energy release rate. This gives

$$\frac{u}{L} = \frac{2GC}{EL \times L} = \frac{2GC}{E \left(\frac{Q_{MAX}}{E} \right)^2} > 1.$$

The error checks are then done for tension and pure shear, respectively,

$$\frac{u}{L} = \frac{(2GIC)}{EN \left(\frac{T}{EN} \right)^2} > 1,$$

$$\frac{u}{L} = \frac{(2GIC)}{ET \left(\frac{S}{ET}\right)^2} > 1.$$

***MAT_MODIFIED_FORCE_LIMITED**

This is Material Type 139. This material for the Belytschko-Schwer resultant beam is an extension of material 29. In addition to the original plastic hinge and collapse mechanisms of material 29, yield moments may be defined as a function of axial force. After a hinge forms, the moment transmitted by the hinge is limited by a moment-plastic rotation relationship.

Card 1	1	2	3	4	5	6	7	8
Variable	MID	R0	E	PR	DF	AOPT	YTFLAG	ASOFT
Type	A8	F	F	F	F	F	F	F
Default	none	none	none	none	0.0	0.0	0.0	0.0

Card 2	1	2	3	4	5	6	7	8
Variable	M1	M2	M3	M4	M5	M6	M7	M8
Type	F	F	F	F	F	F	F	F
Default	none	0	0	0	0	0	0	0

Card 3	1	2	3	4	5	6	7	8
Variable	LC1	LC2	LC3	LC4	LC5	LC6	LC7	LC8
Type	F	F	F	F	F	F	F	F
Default	none	0	0	0	0	0	0	0

MAT_139**MAT_MODIFIED_FORCE_LIMITED**

Card 4	1	2	3	4	5	6	7	8
Variable	LPS1	SFS1	LPS2	SFS2	YMS1	YMS2		
Type	F	F	F	F	F	F		
Default	0	1.0	LPS1	1.0	1.0E+20	YMS1		

Card 5	1	2	3	4	5	6	7	8
Variable	LPT1	SFT1	LPT2	SFT2	YMT1	YMT2		
Type	F	F	F	F	F	F		
Default	0	1.0	LPT1	1.0	1.0E+20	YMT1		

Card 6	1	2	3	4	5	6	7	8
Variable	LPR	SFR	YMR					
Type	F	F	F					
Default	0	1.0	1.0E+20					

Card 7	1	2	3	4	5	6	7	8
Variable	LYS1	SYS1	LYS2	SYS2	LYT1	SYT1	LYT2	SYT2
Type	F	F	F	F	F	F	F	F
Default	0	1.0	0	1.0	0	1.0	0	1.0

Card 8	1	2	3	4	5	6	7	8
Variable	LYR	SYR						
Type	F	F						
Default	0	1.0						

Card 9	1	2	3	4	5	6	7	8
Variable	HMS1_1	HMS1_2	HMS1_3	HMS1_4	HMS1_5	HMS1_6	HMS1_7	HMS1_8
Type	F	F	F	F	F	F	F	F
Default	0	0	0	0	0	0	0	0

Card 10	1	2	3	4	5	6	7	8
Variable	LPMS1_1	LPMS1_2	LPMS1_3	LPMS1_4	LPMS1_5	LPMS1_6	LPMS1_7	LPMS1_8
Type	F	F	F	F	F	F	F	F
Default	0	0	0	0	0	0	0	0

Card 11	1	2	3	4	5	6	7	8
Variable	HMS2_1	HMS2_2	HMS2_3	HMS2_4	HMS2_5	HMS2_6	HMS2_7	HMS2_8
Type	F	F	F	F	F	F	F	F
Default	0	0	0	0	0	0	0	0

MAT_139**MAT_MODIFIED_FORCE_LIMITED**

Card 12	1	2	3	4	5	6	7	8
Variable	LPMS2_1	LPMS2_2	LPMS2_3	LPMS2_4	LPMS2_5	LPMS2_6	LPMS2_7	LPMS2_8
Type	F	F	F	F	F	F	F	F
Default	0	0	0	0	0	0	0	0

Card 13	1	2	3	4	5	6	7	8
Variable	HMT1_1	HMT1_2	HMT1_3	HMT1_4	HMT1_5	HMT1_6	HMT1_7	HMT1_8
Type	F	F	F	F	F	F	F	F
Default	0	0	0	0	0	0	0	0

Card 14	1	2	3	4	5	6	7	8
Variable	LPMT1_1	LPMT1_2	LPMT1_3	LPMT1_4	LPMT1_5	LPMT1_6	LPMT1_7	LPMT1_8
Type	F	F	F	F	F	F	F	F
Default	0	0	0	0	0	0	0	0

Card 15	1	2	3	4	5	6	7	8
Variable	HMT2_1	HMT2_2	HMT2_3	HMT2_4	HMT2_5	HMT2_6	HMT2_7	HMT2_8
Type	F	F	F	F	F	F	F	F
Default	0	0	0	0	0	0	0	0

Card 16	1	2	3	4	5	6	7	8
Variable	LPMT2_1	LPMT2_2	LPMT2_3	LPMT2_4	LPMT2_5	LPMT2_6	LPMT2_7	LPMT2_8
Type	F	F	F	F	F	F	F	F
Default	0	0	0	0	0	0	0	0

Card 17	1	2	3	4	5	6	7	8
Variable	HMR_1	HMR_2	HMR_3	HMR_4	HMR_5	HMR_6	HMR_7	HMR_8
Type	F	F	F	F	F	F	F	F
Default	0	0	0	0	0	0	0	0

Card 18	1	2	3	4	5	6	7	8
Variable	LPMR_1	LPMR_2	LPMR_3	LPMR_4	LPMR_5	LPMR_6	LPMR_7	LPMR_8
Type	F	F	F	F	F	F	F	F
Default	0	0	0	0	0	0	0	0

VARIABLE

DESCRIPTION

MID	Material identification. A unique number or label not exceeding 8 characters must be specified.
RO	Mass density
E	Young's modulus
PR	Poisson's ratio
DF	Damping factor, see definition in notes below. A proper control for the timestep has to be maintained by the user!

VARIABLE	DESCRIPTION
AOPT	Axial load curve option: EQ.0.0: axial load curves are force versus strain, EQ.1.0: axial load curves are force versus change in length. LT.0.0: the absolute value of AOPT is a coordinate system ID number (CID on *DEFINE_COORDINATE_NODES, *DEFINE_COORDINATE_SYSTEM or *DEFINE_COORDINATE_VECTOR). Available in R3 version of 971 and later.
YTFLAG	Flag to allow beam to yield in tension: EQ.0.0: beam does not yield in tension, EQ.1.0: beam can yield in tension.
ASOFT	Axial elastic softening factor applied once hinge has formed. When a hinge has formed the stiffness is reduced by this factor. If zero, this factor is ignored.
M1, M2, ..., M8	Applied end moment for force versus (strain/change in length) curve. At least one must be defined. A maximum of 8 moments can be defined. The values should be in ascending order.
LC1, LC2, ..., LC8	Load curve ID (see *DEFINE_CURVE) defining axial force versus strain/change in length (see AOPT) for the corresponding applied end moment. Define the same number as end moments. Each curve must contain the same number of points.
LPS1	Load curve ID for plastic moment versus rotation about s-axis at node 1. If zero, this load curve is ignored.
SFS1	Scale factor for plastic moment versus rotation curve about s-axis at node 1. Default = 1.0.
LPS2	Load curve ID for plastic moment versus rotation about s-axis at node 2. Default: is same as at node 1.
SFS2	Scale factor for plastic moment versus rotation curve about s-axis at node 2. Default: is same as at node 1.
YMS1	Yield moment about s-axis at node 1 for interaction calculations (default set to 1.0E+20 to prevent interaction).

VARIABLE	DESCRIPTION
YMS2	Yield moment about s-axis at node 2 for interaction calculations (default set to YMS1).
LPT1	Load curve ID for plastic moment versus rotation about t-axis at node 1. If zero, this load curve is ignored.
SFT1	Scale factor for plastic moment versus rotation curve about t-axis at node 1. Default = 1.0.
LPT2	Load curve ID for plastic moment versus rotation about t-axis at node 2. Default: is the same as at node 1.
SFT2	Scale factor for plastic moment versus rotation curve about t-axis at node 2. Default: is the same as at node 1.
YMT1	Yield moment about t-axis at node 1 for interaction calculations (default set to 1.0E+20 to prevent interactions)
YMT2	Yield moment about t-axis at node 2 for interaction calculations (default set to YMT1)
LPR	Load curve ID for plastic torsional moment versus rotation. If zero, this load curve is ignored.
SFR	Scale factor for plastic torsional moment versus rotation (default = 1.0).
YMR	Torsional yield moment for interaction calculations (default set to 1.0E+20 to prevent interaction)
LYS1	ID of curve defining yield moment as a function of axial force for the s-axis at node 1.
SYS1	Scale factor applied to load curve LYS1.
LYS2	ID of curve defining yield moment as a function of axial force for the s-axis at node 2.
SYS2	Scale factor applied to load curve LYS2.
LYT1	ID of curve defining yield moment as a function of axial force for the t-axis at node 1.
SYT1	Scale factor applied to load curve LYT1.

VARIABLE	DESCRIPTION
LYT2	ID of curve defining yield moment as a function of axial force for the t-axis at node 2.
SYT2	Scale factor applied to load curve LYT2.
LYR	ID of curve defining yield moment as a function of axial force for the torsional axis.
SYR	Scale factor applied to load curve LYR.
HMS1_n	Hinge moment for s-axis at node 1.
LPMS1_n	ID of curve defining plastic moment as a function of plastic rotation for the s-axis at node 1 for hinge moment HMS1_n
HMS2_n	Hinge moment for s-axis at node 2.
LPMS2_n	ID of curve defining plastic moment as a function of plastic rotation for the s-axis at node 2 for hinge moment HMS2_n
HMT1_n	Hinge moment for t-axis at node 1.
LPMT1_n	ID of curve defining plastic moment as a function of plastic rotation for the t-axis at node 1 for hinge moment HMT1_n
HMT2_n	Hinge moment for t-axis at node 2.
LPMT2_n	ID of curve defining plastic moment as a function of plastic rotation for the t-axis at node 2 for hinge moment HMT2_n
HMR_n	Hinge moment for the torsional axis.
LPMR_n	ID of curve defining plastic moment as a function of plastic rotation for the torsional axis for hinge moment HMR_n

Remarks:

This material model is available for the Belytschko resultant beam element only. Plastic hinges form at the ends of the beam when the moment reaches the plastic moment. The plastic moment versus rotation relationship is specified by the user in the form of a load curve and scale factor. The points of the load curve are (plastic rotation in radians, plastic moment). Both quantities should be positive for all points, with the first point being (zero, initial plastic moment). Within this constraint any form of characteristic may be used, including flat or falling curves. Different load curves and scale factors may be specified at each node and about each of the local s and t axes.

Axial collapse occurs when the compressive axial load reaches the collapse load. Collapse load versus collapse deflection is specified in the form of a load curve. The points of the load curve are either (true strain, collapse force) or (change in length, collapse force). Both quantities should be entered as positive for all points, and will be interpreted as compressive. The first point should be (zero, initial collapse load).

The collapse load may vary with end moment as well as with deflections. In this case several load-deflection curves are defined, each corresponding to a different end moment. Each load curve should have the same number of points and the same deflection values. The end moment is defined as the average of the absolute moments at each end of the beam and is always positive.

Stiffness-proportional damping may be added using the damping factor λ . This is defined as follows:

$$\lambda = \frac{2 \times \xi}{\omega}$$

where ξ is the damping factor at the reference frequency ω (in radians per second). For example if 1% damping at 2Hz is required

$$\lambda = \frac{2 \times 0.01}{2\pi \times 2} = 0.001592$$

If damping is used, a small time step may be required. LS-DYNA does not check this so to avoid instability it may be necessary to control the time step via a load curve. As a guide, the time step required for any given element is multiplied by $0.3L/c\lambda$ when damping is present (L = element length, c = sound speed).

Moment Interaction:

Plastic hinges can form due to the combined action of moments about the three axes. This facility is activated only when yield moments are defined in the material input. A hinge forms when the following condition is first satisfied.

$$\left(\frac{M_r}{M_{r\text{yield}}}\right)^2 + \left(\frac{M_s}{M_{s\text{yield}}}\right)^2 + \left(\frac{M_t}{M_{t\text{yield}}}\right)^2 \geq 1$$

where,

$$M_r, M_s, M_t, = \text{current moment}$$
$$M_{r\text{yield}}, M_{s\text{yield}}, M_{t\text{yield}} = \text{yield moment}$$

Note that scale factors for hinge behavior defined in the input will also be applied to the yield moments: for example, $M_{s\text{yield}}$ in the above formula is given by the input yield moment about the local axis times the input scale factor for the local s axis. For strain-

softening characteristics, the yield moment should generally be set equal to the initial peak of the moment-rotation load curve.

On forming a hinge, upper limit moments are set. These are given by

$$M_{r_{upper}} = \max\left(M_{r'}, \frac{M_{r_{yield}}}{2}\right)$$

and similar conditions hold for $M_{s_{upper}}$ and $M_{t_{upper}}$. Thereafter the plastic moments will be given by

$$M_{r_p} = \min(M_{r_{upper}}, M_{r_{curve}})$$

where,

M_{r_p} = current plastic moment

$M_{r_{curve}}$ = moment from load curve at the current rotation scaled by the scale factor.

M_{s_p} and M_{t_p} satisfy similar conditions.

The effect of this is to provide an upper limit to the moment that can be generated; it represents the softening effect of local buckling at a hinge site. Thus if a member is bent about its local s-axis it will then be weaker in torsion and about its local t-axis. For moments-softening curves, the effect is to trim off the initial peak (although if the curves subsequently harden, the final hardening will also be trimmed off).

It is not possible to make the plastic moment vary with the current axial load, but it is possible to make hinge formation a function of axial load and subsequent plastic moment a function of the moment at the time the hinge formed. This is discussed in the next section.

Independent plastic hinge formation:

In addition to the moment interaction equation, Cards 7 through 18 allow plastic hinges to form independently for the s-axis and t-axis at each end of the beam and also for the torsional axis. A plastic hinge is assumed to form if any component of the current moment exceeds the yield moment as defined by the yield moment vs. axial force curves input on cards 7 and 8. If any of the 5 curves is omitted, a hinge will not form for that component. The curves can be defined for both compressive and tensile axial forces. If the axial force falls outside the range of the curve, the first or last point in the curve will be used. A hinge forming for one component of moment does not effect the other components.

Upon forming a hinge, the magnitude of that component of moment will not be permitted to exceed the current plastic moment.. The current plastic moment is obtained by interpolating between the plastic moment vs. plastic rotation curves input on cards 10, 12, 14, 16, or 18. Curves may be input for up to 8 hinge moments, where the hinge moment is defined as the yield moment at the time that the hinge formed. Curves must be input in order of

increasing hinge moment and each curve should have the same plastic rotation values. The first or last curve will be used if the hinge moment falls outside the range of the curves. If no curves are defined, the plastic moment is obtain from the curves on cards 4 through 6. The plastic moment is scaled by the scale factors on lines 4 to 6.

A hinge will form if either the independent yield moment is exceeded or if the moment interaction equation is satisfied. If both are true, the plastic moment will be set to the minimum of the interpolated value and M_{rp} .

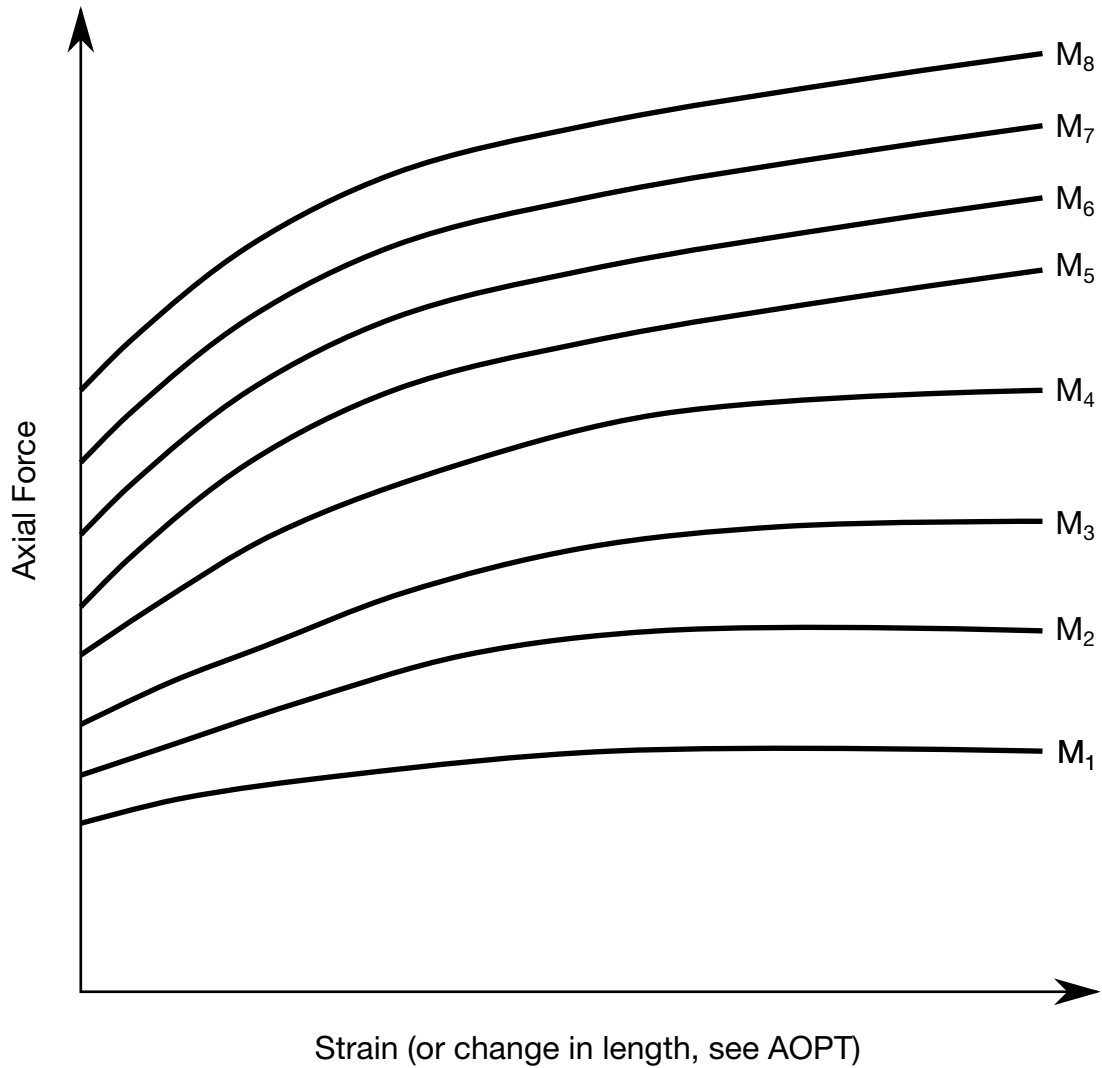

Figure 2-81. The force magnitude is limited by the applied end moment. For an intermediate value of the end moment LS-DYNA interpolates between the curves to determine the allowable force value.

***MAT_VACUUM**

This is Material Type 140. This model is a dummy material representing a vacuum in a multi-material Euler/ALE model. Instead of using ELFORM = 12 (under *SECTION_SOLID), it is better to use ELFORM = 11 with the void material defined as vacuum material instead.

Card 1	1	2	3	4	5	6	7	8
Variable	MID	RHO						
Type	A8	F						

VARIABLE**DESCRIPTION**

MID	Material identification. A unique number or label not exceeding 8 characters must be specified.
RHO	Estimated material density. This is used only as stability check.

Remarks:

1. The vacuum density is estimated. It should be small relative to air in the model (possibly at least 10^3 to 10^6 lighter than air).

***MAT_RATE_SENSITIVE_POLYMER**

This is Material Type 141. This model, called the modified Ramaswamy-Stouffer model, is for the simulation of an isotropic ductile polymer with strain rate effects. See references; Stouffer and Dame [1996] and Goldberg and Stouffer [1999]. Uniaxial test data is used to fit the material parameters.

Card 1	1	2	3	4	5	6	7	8
Variable	MID	RO	E	PR	Do	N	Zo	q
Type	A8	F	F	F	F	F	F	F

Card 2	1	2	3	4	5	6	7	8
Variable	Omega							
Type	F							

VARIABLE**DESCRIPTION**

MID	Material identification. A unique number or label not exceeding 8 characters must be specified.
RO	Mass density
E	Elastic modulus.
PR	Poisson's ratio
Do	Reference strain rate (= 1000 × max strain rate used in the test).
N	Exponent (see inelastic strain rate equation below)
Zo	Initial hardness of material
q	(see equations below).
Omega	Maximum internal stress.

Remarks:

The inelastic strain rate is defined as:

$$\dot{\epsilon}_{ij}^I = D_o \exp \left[-0.5 \left(\frac{Z_o^2}{3K_2} \right) \right] \left(\frac{S_{ij} - \Omega_{ij}}{\sqrt{K_2}} \right)$$

where the K_2 term is given as:

$$K_2 = 0.5(S_{ij} - \Omega_{ij})(S_{ij} - \Omega_{ij})$$

and represents the second invariant of the overstress tensor. The elastic components of the strain are added to the inelastic strain to obtain the total strain. The following relationship defines the back stress variable rate:

$$\dot{\Omega}_{ij} = \frac{2}{3} q \Omega_m \dot{\epsilon}_{ij}^I - q \Omega_{ij} \dot{\epsilon}_e^I$$

where q is a material constant, Ω_m is a material constant that represents the maximum value of the internal stress, and $\dot{\epsilon}_e^I$ is the effective inelastic strain rate.

***MAT_TRANSVERSELY_ISOTROPIC_CRUSHABLE_FOAM**

This is Material Type 142. This model is for an extruded foam material that is transversely isotropic, crushable, and of low density with no significant Poisson effect. This material is used in energy-absorbing structures to enhance automotive safety in low velocity (bumper impact) and medium high velocity (interior head impact and pedestrian safety) applications. The formulation of this foam is due to Hirth, Du Bois, and Weimar and is documented by Du Bois [2001]. This model behaves in a more physical way for off axis loading the material, *MAT_HONEYCOMB, which can exhibit nonphysical stiffening for loading conditions that are off axis. The load curves are used to define a yield surface that bounds the deviatoric stress tensor.

Card 1	1	2	3	4	5	6	7	8
Variable	MID	R0	E11	E22	E12	E23	G	K
Type	A8	F	F	F	F	F	F	F

Card 2	1	2	3	4	5	6	7	8
Variable	I11	I22	I12	I23	IAA	NY	ANG	MU
Type	I	I	I	I	I	I	F	F

Card 3	1	2	3	4	5	6	7	8
Variable	AOPT	ISCL	MACF					
Type	F	I	I					

Card 4	1	2	3	4	5	6	7	8
Variable	XP	YP	ZP	A1	A2	A3		
Type	F	F	F	F	F	F		

Card 5	1	2	3	4	5	6	7	8
Variable	D1	D2	D3	V1	V2	V3		
Type	F	F	F	F	F	F		

VARIABLE**DESCRIPTION**

MID	Material identification. A unique number or label not exceeding 8 characters must be specified.
RO	Mass density
E11	Elastic modulus in axial direction.
E22	Elastic modulus in transverse direction (E22 = E33).
E12	Elastic shear modulus (E12 = E31).
E23	Elastic shear modulus in transverse plane.
G	Shear modulus.
K	Bulk modulus for contact stiffness.
I11	Load curve for nominal axial stress versus volumetric strain.
I22	Load curve ID for nominal transverse stresses versus volumetric strain (I22 = I33).
I12	Load curve ID for shear stress component 12 and 31 versus volumetric strain (I12 = I31).
I23	Load curve ID for shear stress component 23 versus volumetric strain.
IAA	Load curve ID (optional) for nominal stress versus volumetric strain for load at angle, ANG, relative to the material axis.
NY	Set to unity for a symmetric yield surface.
ANG	Angle corresponding to load curve ID, IAA.

VARIABLE	DESCRIPTION
MU	Damping coefficient for tensor viscosity which acts in both tension and compression. Recommended values vary between 0.05 to 0.10. If zero, tensor viscosity is not used, but bulk viscosity is used instead. Bulk viscosity creates a pressure as the element compresses that is added to the normal stresses, which can have the effect of creating transverse deformations when none are expected.
AOPT	Material axes option (see MAT_OPTIONTROPIC_ELASTIC for a more complete description): <ul style="list-style-type: none">EQ.0.0: locally orthotropic with material axes determined by element nodes as shown in Figure 2-3. Nodes 1, 2, and 4 of an element are identical to the nodes used for the definition of a coordinate system as by *DEFINE_COORDINATE_NODES.EQ.1.0: locally orthotropic with material axes determined by a point in space and the global location of the element center; this is the a-direction. This option is for solid elements only.EQ.2.0: globally orthotropic with material axes determined by vectors defined below, as with *DEFINE_COORDINATE_VECTOR.EQ.3.0: locally orthotropic material axes determined by rotating the material axes about the element normal by an angle, BETA, from a line in the plane of the element defined by the cross product of the vector v with the element normal. The plane of a solid element is the midsurface between the inner surface and outer surface defined by the first four nodes and the last four nodes of the connectivity of the element, respectively.EQ.4.0: locally orthotropic in cylindrical coordinate system with the material axes determined by a vector v, and an originating point, P, which define the centerline axis. This option is for solid elements only.LT.0.0: the absolute value of AOPT is a coordinate system ID number (CID on *DEFINE_COORDINATE_NODES, *DEFINE_COORDINATE_SYSTEM or *DEFINE_COORDINATE_VECTOR). Available in R3 version of 971 and later.

VARIABLE	DESCRIPTION
ISCL	Load curve ID for the strain rate scale factor versus the volumetric strain rate. The yield stress is scaled by the value specified by the load curve.
MACF	Material axes change flag: EQ.1: No change, default, EQ.2: switch material axes a and b, EQ.3: switch material axes a and c, EQ.4: switch material axes b and c.
XP YP ZP	Coordinates of point p for AOPT = 1 and 4.
A1 A2 A3	Components of vector a for AOPT = 2.
D1 D2 D3	Components of vector d for AOPT = 2.
V1 V2 V3	Define components of vector v for AOPT = 3 and 4.

Remarks:

Tensor viscosity, which is activated by a nonzero value for MU, is generally more stable than bulk viscosity. A damping coefficient less than 0.01 has little effect, and a value greater than 0.10 may cause numerical instabilities.

*MAT_WOOD_{OPTION}

This is Material Type 143. This is a transversely isotropic material and is available for solid elements. The user has the option of inputting his or her own material properties (<BLANK>), or requesting default material properties for Southern yellow pine (PINE) or Douglas fir (FIR). This model was developed by Murray [2002] under a contract from the FHWA.

Available options include:

<BLANK>

PINE

FIR

Card 1	1	2	3	4	5	6	7	8
Variable	MID	RO	NPLOT	ITERS	IRATE	GHARD	IFAIL	IVOL
Type	A8	F	I	I	I	F	I	I

Card 2 for PINE and FIR keyword options.

Card 2	1	2	3	4	5	6	7	8
Variable	MOIS	TEMP	QUAL_T	QUAL_C	UNITS	IQUAL		
Type	F	F	F	F	I	I		

The following cards 2 through 6 are for option left blank.

Card 2	1	2	3	4	5	6	7	8
Variable	EL	ET	GLT	GTR	PR			
Type	F	F	F	F	F			

Card 3	1	2	3	4	5	6	7	8
Variable	XT	XC	YT	YC	SXY	SYZ		
Type	F	F	F	F	F	F		

Card 4	1	2	3	4	5	6	7	8
Variable	GF1II	GF2II	BFIT	DMAXII	GF1 \perp	GF2 \perp	DFIT	DMAX \perp
Type	F	F	F	F	F	F	F	F

Card 5	1	2	3	4	5	6	7	8
Variable	FLPAR	FLPARC	POWPAR	FLPER	FLPERC	POWPER		
Type	F	F	F	F	F	F		

Card 6	1	2	3	4	5	6	7	8
Variable	NPAR	CPAR	NPER	CPER				
Type	F	F	F	F				

The remaining cards *all* keyword options.

Card 7	1	2	3	4	5	6	7	8
Variable	AOPT	MACF	BETA					
Type	F	I	F					

Card 8	1	2	3	4	5	6	7	8
Variable	XP	YP	ZP	A1	A2	A3		
Type	F	F	F	F	F	F		

Card 9	1	2	3	4	5	6	7	8
Variable	D1	D2	D3	V1	V2	V3		
Type	F	F	F	F	F	F		

VARIABLE	DESCRIPTION
MID	Material identification. A unique number or label not exceeding 8 characters must be specified.
RO	Mass density
NPLOT	Controls what is written as component 7 to the d3plot database. LS-PrePost always blindly labels this component as effective plastic strain.: EQ.1: Parallel damage (default). EQ.2: Perpendicular damage.
ITERS	Number of plasticity algorithm iterations. The default is one iteration.
IRATE	Rate effects option: EQ.0: Rate effects model turned off (default). EQ.1: Rate effects model turned on.
GHARD	Perfect plasticity override. Values greater than or equal to zero are allowed. Positive values model late time hardening in compression (an increase in strength with increasing strain). A zero value models perfect plasticity (no increase in strength with increasing strain). The default is zero.
IFAIL	Erosion perpendicular to the grain. EQ.0: No (default).

	EQ.1: Yes (not recommended except for debugging).
IVOL	Flag to invoke erosion based on negative volume or strain increments greater than 0.01. EQ.0: No, do not apply erosion criteria. EQ.1: Yes, apply erosion criteria.
MOIS	Percent moisture content. If left blank, moisture content defaults to saturated at 30%.
TEMP	Temperature in °C. If left blank, temperature defaults to room temperature at 20 °C
QUAL_T	Quality factor options. These quality factors reduce the clear wood tension, shear, and compression strengths as a function of grade. EQ.0: Grade 1, 1D, 2, 2D. Predefined strength reduction factors are: Pine: QUAL_T = 0.47 in tension/shear. QUAL_C = 0.63 in compression. Fir: QUAL_T = 0.40 in tension/shear QUAL_C = 0.73 in compression. EQ.-1: DS-65 or SEI STR (pine and fir). Predefined strength reduction factors are: QUAL_T = 0.80 in tension/shear. QUAL_C = 0.93 in compression. EQ.-2: Clear wood. No strength reduction factors are applied: QUAL_T = 1.0. QUAL_C = 1.0. GT.0: User defined quality factor in tension. Values between 0 and 1 are expected. Values greater than one are allowed, but may not be realistic.
QUAL_C	User defined quality factor in compression. This input value is used if Qual_T > 0. Values between 0 and 1 are expected. Values greater than one are allowed, but may not be realistic. If left blank, a default value of Qual_C = Qual_T is used.

UNITS	Units options: EQ.0: GPa, mm, msec, Kg/mm ³ , kN. EQ.1: MPa, mm, msec, g/mm ³ , Nt. EQ.2: MPa, mm, sec, Mg/mm ³ , Nt. EQ.3: Psi, inch, sec, lb-s ² /inch ⁴ , lb
IQUAL	Apply quality factors perpendicular to the grain: EQ.0: Yes (default). EQ.1: No.
EL	Parallel normal modulus
ET	Perpendicular normal modulus.
GLT	Parallel shear modulus (GLT = GLR).
GTR	Perpendicular shear modulus.
PR	Parallel major Poisson's ratio.
XT	Parallel tensile strength.
XC	Parallel compressive strength.
YT	Perpendicular tensile strength.
YC	Perpendicular compressive strength.
SXY	Parallel shear strength.
SYZ	Perpendicular shear strength.
GF1	Parallel fracture energy in tension.
GF2	Parallel fracture energy in shear.
BFIT	Parallel softening parameter.
DMAX	Parallel maximum damage.
GF1 [⊥]	Perpendicular fracture energy in tension.
GF2 [⊥]	Perpendicular fracture energy in shear.

DFIT	Perpendicular softening parameter.
DMAX [⊥]	Perpendicular maximum damage.
FLPAR	Parallel fluidity parameter for tension and shear.
FLPARC	Parallel fluidity parameter for compression.
POWPAR	Parallel power.
FLPER	Perpendicular fluidity parameter for tension and shear.
FLPERC	Perpendicular fluidity parameter for compression.
POWPER	Perpendicular power.
NPAR	Parallel hardening initiation.
CPAR	Parallel hardening rate
NPER	Perpendicular hardening initiation.
CPER	Perpendicular hardening rate.
AOPT	Material axes option (see <i>MAT_OPTION TROPIC_ELASTIC</i> for a more complete description): <ul style="list-style-type: none">EQ.0.0: locally orthotropic with material axes determined by element nodes as shown in Figure 2-3. Nodes 1, 2, and 4 of an element are identical to the nodes used for the definition of a coordinate system as by *DEFINE_COORDINATE_NODES.EQ.1.0: locally orthotropic with material axes determined by a point in space and the global location of the element center; this is the a-direction. This option is for solid elements only.EQ.2.0: globally orthotropic with material axes determined by vectors defined below, as with *DEFINE_COORDINATE_VECTOR.EQ.3.0: locally orthotropic material axes determined by rotating the material axes about the element normal by an angle, BETA, from a line in the plane of the element defined by the cross product of the vector v with the element normal. The plane of a solid element is the midsurface between the inner surface and outer surface defined by the first four nodes and the last four nodes of the connecti-

ty of the element, respectively.

EQ.4.0: locally orthotropic in cylindrical coordinate system with the material axes determined by a vector \mathbf{v} , and an originating point, P , which define the centerline axis. This option is for solid elements only.

LT.0.0: the absolute value of AOPT is a coordinate system ID number (CID on *DEFINE_COORDINATE_NODES, *DEFINE_COORDINATE_SYSTEM or *DEFINE_COORDINATE_VECTOR). Available in R3 version of 971 and later.

MACF	Material axes change flag: EQ.1: No change, default, EQ.2: switch material axes a and b, EQ.3: switch material axes a and c, EQ.4: switch material axes b and c.
BETA	Material angle in degrees for AOPT = 3, may be overridden on the element card, see *ELEMENT_SOLID_ORTHO.
XP YP ZP	Coordinates of point \mathbf{p} for AOPT = 1 and 4.
A1 A2 A3	Components of vector \mathbf{a} for AOPT = 2.
D1 D2 D3	Components of vector \mathbf{d} for AOPT = 2.
V1 V2 V3	Define components of vector \mathbf{v} for AOPT = 3 and 4.

Remarks:

Material property data is for clear wood (small samples without defects like knots), whereas real structures are composed of graded wood. Clear wood is stronger than graded wood. Quality factors (strength reduction factors) are applied to the clear wood strengths to account for reductions in strength as a function of grade. One quality factor (QUAL_T) is applied to the tensile and shear strengths. A second quality factor (QUAL_C) is applied to the compressive strengths. As a option, predefined quality factors are provided based on correlations between LS-DYNA calculations and test data for pine and fir posts impacted by bogie vehicles. By default, quality factors are applied to both the parallel and perpendicular to the grain strengths. An option is available (IQUAL) to eliminate application perpendicular to the grain.

***MAT_PITZER_CRUSHABLE_FOAM**

This is Material Type 144. This model is for the simulation of isotropic crushable forms with strain rate effects. Uniaxial and triaxial test data have to be used. For the elastic response, the Poisson ratio is set to zero.

Card 1	1	2	3	4	5	6	7	8
Variable	MID	RO	K	G	PR	TY	SRTV	
Type	A8	F	F	F	F	F	F	

Card 2	1	2	3	4	5	6	7	8
Variable	LCPY	LCUYS	LCSR	VC	DFLG			
Type	I	I	I	F	F			

VARIABLE**DESCRIPTION**

MID	Material identification. A unique number or label not exceeding 8 characters must be specified.
RO	Mass density
K	Bulk modulus.
G	Shear modulus
PR	Poisson's ratio
TY	Tension yield.
SRTV	Young's modulus (E)
LCPY	Load curve ID giving pressure versus volumetric strain, see Figure 2-43 .
LCUYS	Load curve ID giving uniaxial stress versus volumetric strain, see Figure 2-43 .
LCSR	Load curve ID giving strain rate scale factor versus volumetric strain rate.

<u>VARIABLE</u>	<u>DESCRIPTION</u>
VC	Viscous damping coefficient (.05 < recommended value < .50).
DFLG	Density flag: EQ.0.0: use initial density EQ.1.0: use current density (larger step size with less mass scaling).

Remarks:

The logarithmic volumetric strain is defined in terms of the relative volume, V , as:

$$\gamma = -\ln(V)$$

In defining the curves the stress and strain pairs should be positive values starting with a volumetric strain value of zero.

***MAT_SCHWER_MURRAY_CAP_MODEL**

This is Material Type 145. The Schwer & Murray Cap Model, known as the Continuous Surface Cap Model, is a three invariant extension of the Geological Cap Model (Material Type 25) that also includes viscoplasticity for rate effects and damage mechanics to model strain softening. The primary references are Schwer and Murray [1994], Schwer [1994], and Murray and Lewis [1994]. The model is appropriate for geomaterials including soils, concrete, and rocks.

Warning: no default input parameter values are assumed, but recommendations for the more obscure parameters are provided in the descriptions that follow.

Card 1	1	2	3	4	5	6	7	8
Variable	MID	RO	SHEAR	BULK	GRUN	SHOCK	PORE	
Type	A8	F	F	F	F	F	F	

Card 2	1	2	3	4	5	6	7	8
Variable	ALPHA	THETA	GAMMA	BETA	EFIT	FFIT	ALPHAN	CALPHA
Type	F	F	F	F	F	F	F	F

Card 3	1	2	3	4	5	6	7	8
Variable	RO	XO	IROCK	SECP	AFIT	BFIT	RDAMO	
Type	F	F	F	F	F	F	F	

Card 4	1	2	3	4	5	6	7	8
Variable	W	D1	D2	NPLOT	EPSMAX	CFIT	DFIT	TFAIL
Type	F	F	F	F	F	F	F	F

Card 5	1	2	3	4	5	6	7	8
Variable	FAILFL	DBETA	DDELTA	VPTAU				
Type	F	F	F	F				

Card 6	1	2	3	4	5	6	7	8
Variable	ALPHA1	THETA1	GAMMA1	BETA1	ALPHA2	THETA2	GAMMA2	BETA2
Type	F	F	F	F	F	F	F	F

VARIABLE**DESCRIPTION**

MID	Material identification. A unique number or label not exceeding 8 characters must be specified.
RO	Mass density
SHEAR	Shear modulus, G
BULK	Bulk modulus, K
GRUN	Gruneisen ratio (typically = 0), Γ
SHOCK	Shock velocity parameter (typically 0), S_1
PORE	Flag for pore collapse EQ.0.0: for Pore collapse EQ.1.0: for Constant bulk modulus (typical)
ALPHA	Shear failure parameter, α
THETA	Shear failure parameter, θ
GAMMA	Shear failure parameter, γ
BETA	Shear failure parameter, β
	$\sqrt{J'_2} = F_e(J_1) = \alpha - \gamma \exp(-\beta J_1) + \theta J_1$
EFIT	Dilatation damage mechanics parameter (no damage = 1)

VARIABLE	DESCRIPTION
FFIT	Dilatation damage mechanics parameter (no damage = 0)
ALPHAN	Kinematic strain hardening parameter, N^α
CALPHAN	Kinematic strain hardening parameter, c^α
R0	Initial cap surface ellipticity, R
X0	Initial cap surface J_1 (mean stress) axis intercept, $X(\kappa_0)$
IROCK	EQ.0: soils (cap can contract) EQ.1: rock/concrete
SECP	Shear enhanced compaction
AFIT	Ductile damage mechanics parameter (=1 no damage)
BFIT	Ductile damage mechanics parameter (=0 no damage)
RDAM0	Ductile damage mechanics parameter
W	Plastic Volume Strain parameter, W
D1	Plastic Volume Strain parameter, D_1
D2	Plastic Volume Strain parameter, D_2 $\varepsilon_V^P = W \left\{ 1 - \exp \left\{ -D_1 [X(\kappa) - X(\kappa_0)] - D_2 [(X(\kappa) - X(\kappa_0))]^2 \right\} \right\}$
NPLOT	History variable post-processed as effective plastic strain (See Table 2-82 for history variables available for plotting)
EPSMAX	Maximum permitted strain increment (default = 0) $\Delta\varepsilon_{\max} = 0.05(\alpha - N^\alpha - \gamma) \min\left(\frac{1}{G}, \frac{R}{9K}\right)$ (calculated default)
CFIT	Brittle damage mechanics parameter (=1 no damage)
DFIT	Brittle damage mechanics parameter (=0 no damage)
TFAIL	Tensile failure stress

VARIABLE	DESCRIPTION
FAILFL	Flag controlling element deletion and effect of damage on stress (see Remarks 1 and 2): EQ.1: σ_{ij} reduces with increasing damage; element is deleted when fully damaged (default) EQ.-1: σ_{ij} reduces with increasing damage; element is not deleted EQ.2: S_{ij} reduces with increasing damage; element is deleted when fully damaged EQ.-2: S_{ij} reduces with increasing damage; element is not deleted
DBETA	Rounded vertices parameter, $\Delta\beta_0$
DDELTA	Rounded vertices parameter, δ
VPTAU	Viscoplasticity relaxation time parameter, τ
ALPHA1	Torsion scaling parameter, α_1 $\alpha_1 < 0 \rightarrow \alpha_1 = \text{Friction Angle (degrees)}$
THETA1	Torsion scaling parameter, θ_1
GAMMA1	Torsion scaling parameter, γ_1
BETA1	Torsion scaling parameter, β_1 $Q_1 = \alpha_1 - \gamma_1 \exp(-\beta_1 J_1) + \theta_1 J_1$
ALPHA2	Tri-axial extension scaling parameter, α_2
THETA2	Tri-axial extension scaling parameter, θ_2
GAMMA2	Tri-axial extension scaling parameter, γ_2
BETA2	Tri-axial extension scaling parameter, β_2 $Q_2 = \alpha_2 - \gamma_2 \exp(-\beta_2 J_1) + \theta_2 J_1$

Remarks:

1. FAILFL controls whether the damage accumulation applies to either the total stress tensor σ_{ij} or the deviatoric stress tensor S_{ij} . When FAILFL = 2, damage does not diminish the ability of the material to support hydrostatic stress.
2. FAILFL also serves as a flag to control element deletion. Fully damaged elements are deleted only if FAILFL is a positive value. When MAT_145 is used with the

ALE or EFG solvers, failed elements should not be eroded and so a negative value of FAILFL should be used.

Output History Variables:

All the output parameters listed in [Table 2-82](#) is available for post-processing using LS-PrePost and its displayed list of History Variables. The LS-DYNA input parameter NEIPH should be set to 26; see for example the keyword input for *DATABASE_EXTENT_BINARY.

<i>PLOT</i>	<i>Function</i>	<i>Description</i>
1	$X(\kappa)$	J_1 intercept of cap surface
2	$L(\kappa)$	J_1 value at cap-shear surface intercept
3	R	Cap surface ellipticity
4	\tilde{R}	Rubin function
5	ε_v^p	Plastic volume strain
6		Yield Flag (= 0 elastic)
7		Number of strain sub-increments
8	G^α	Kinematic hardening parameter
9	J_2^α	Kinematic hardening back stress
10		Effective strain rate
11		Ductile damage
12		Ductile damage threshold
13		Strain energy
14		Brittle damage
15		Brittle damage threshold
16		Brittle energy norm
17		J_1 (w/o visco-damage/plastic)
18		J'_2 (w/o visco-damage/plastic)
19		J'_3 (w/o visco-damage/plastic)
20		\hat{J}_3 (w/o visco-damage/plastic)
21	β	Lode Angle
22	d	Maximum damage parameter
23		future variable
24		future variable
25		future variable
26		future variable

Table 2-82. Output variables for post-processing using NPLOT parameter.

Sample Input for Concrete

Gran and Senseny [1996] report the axial stress versus strain response for twelve unconfined compression tests of concrete, used in scale-model reinforced-concrete wall tests. The Schwer & Murray Cap Model parameters provided below were used, see Schwer [2001], to model the unconfined compression test stress-strain response for the nominal 40 MPa strength concrete reported by Gran and Senseny. The basic units for the provided parameters are length in millimeters (mm), time in milliseconds (msec), and mass in grams (g). This base unit set yields units of force in Newtons (N) and pressure in Mega-Pascals (MPa).

Example MAT_SCHWER_MURRAY_CAP_MODEL deck

Card 1	1	2	3	4	5	6	7	8
Variable	MID	R0	SHEAR	BULK	GRUN	SHOCK	PORE	
Value	A8	2.3E-3	1.048E4	1.168E4	0.0	0.0	1.	

Card 2	1	2	3	4	5	6	7	8
Variable	ALPHA	THETA	GAMMA	BETA	EFIT	FFIT	ALPHAN	CALPHA
Value	190.0	0.0	184.2	2.5E-3	0.999	0.7	2.5	2.5E3

Card 3	1	2	3	4	5	6	7	8
Variable	R0	X0	IROCK	SECP	AFIT	BFIT	RDAM0	
Value	5.0	100.0	1.0	0.0	0.999	0.3	0.94	

Card 4	1	2	3	4	5	6	7	8
Variable	W	D1	D2	NPLOT	EPSMAX	CFIT	DFIT	TFAIL
Value	5.0E-2	2.5E-4	3.5E-7	23.0	0.0	1.0	300.0	7.0

Card 5	1	2	3	4	5	6	7	8
Variable	FAILFG	DBETA	DDELTA	VPTAU				
Value	1.0	0.0	0.0	0.0				

Card 6	1	2	3	4	5	6	7	8
Variable	ALPHA1	THETA1	GAMMA1	BETA1	ALPHA2	THETA2	GAMMA2	BETA2
Value	0.747	3.3E-4	0.17	5.0E-2	0.66	4.0E-4	0.16	5.0E-2

User Input Parameters and System of Units

Consider the following basic units:

Length: L (e.g. millimeters - mm)

Mass: M (e.g. grams - g)

Time: T (e.g. milliseconds - ms)

The following consistent unit systems can then be derived using Newton's Law, i.e. $F = Ma$.

Force: $F = ML/T^2$ [g-mm/ms² = Kg-m/s² = Newton - N]

Stress: $\sigma = F/L^2$ [N/mm² = 10⁶N/m² = 10⁶ Pascals = MPa]

Density: $\rho = M/L^3$ [g/mm³ = 10⁶ Kg/m³]

User Inputs and Units

Card 1	1	2	3	4	5	6	7	8
Variable	MID	R0	SHEAR	BULK	GRUN	SHOCK	PORE	
Units	I	Density M/L ³	Stress: F/L ²	Stress: F/L ²				

Card 2	1	2	3	4	5	6	7	8
Variable	ALPHA	THETA	GAMMA	BETA	EFIT	FFIT	ALPHAN	CALPHA
Units	Stress: F/L ²		Stress: F/L ²	Stress ⁻¹ : L ² /F		Stress ^{-1/2} : L/F ^{1/2}	Stress: F/L ²	Stress: F/L ²

Card 3	1	2	3	4	5	6	7	8
Variable	R0	X0	IROCK	SECP	AFIT	BFIT	RDAM0	
Units		Stress: F/L ²				Stress ^{-1/2} : L/F ^{1/2}	Stress ^{1/2} : F ^{1/2} /L	

Card 4	1	2	3	4	5	6	7	8
Variable	W	D1	D2	NPLOT	MAXEPS	CFIT	DFIT	TFAIL
Units		Stress ⁻¹ : L ² /F	Stress ⁻² : L ⁴ /F ²				Stress ^{-1/2} : L/F ^{1/2}	Stress: F/L ²

Card 5	1	2	3	4	5	6	7	8
Variable	FAILFG	DBETA	DDELTA	VPTAU				
Units		Angle degrees		Time T				

Card 6	1	2	3	4	5	6	7	8
Variable	ALPHA1	THETA1	GAMMA1	BETA1	ALPHA2	THETA2	GAMMA2	BETA2
Units	Stress: F/L ²		Stress: F/L ²	Stress ⁻¹ : L ² /F	Stress: F/L ²		Stress: F/L ²	Stress ⁻¹ : L ² /F

***MAT_1DOF_GENERALIZED_SPRING**

This is Material Type 146. This is a linear spring or damper that allows different degrees-of-freedom at two nodes to be coupled.

Card 1	1	2	3	4	5	6	7	8
Variable	MID	RO	K	C	SCLN1	SCLN2	DOFN1	DOFN2
Type	A8	F	F	F	F	F	I	I

Card 2	1	2	3	4	5	6	7	8
Variable	CID1	CID2						
Type	I	I						

VARIABLE**DESCRIPTION**

MID	Material identification. A unique number or label not exceeding 8 characters must be specified.
RO	Mass density, see also volume in *SECTION_BEAM definition.
K	Spring stiffness.
C	Damping constant.
SCLN1	Scale factor on force at node 1. Default = 1.0.
SCLN2	Scale factor on force at node 2. Default = 1.0.
DOFN1	Active degree-of-freedom at node 1, a number between 1 to 6 where 1 is x-translation and 4 is x-rotation. If this parameter is defined in the SECTION_BEAM definition or on the ELEMENT_BEAM_SCALAR card, then the value here, if defined, is ignored.
DOFN2	Active degree-of-freedom at node 2, a number between 1 to 6. If this parameter is defined in the SECTION_BEAM definition or on the ELEMENT_BEAM_SCALAR card, then the value here, if defined, is ignored.

VARIABLE	DESCRIPTION
CID1	Local coordinate system at node 1. This coordinate system can be overwritten by a local system specified on the *ELEMENT_BEAM_-SCALAR or *SECTION_BEAM keyword input. If no coordinate system is specified, the global system is used.
CID2	Local coordinate system at node 2. If CID2 = 0, CID2 = CID1.

***MAT_FHWA_SOIL**

This is Material Type 147. This is an isotropic material with damage and is available for solid elements. The model has a modified Mohr-Coulomb surface to determine the pressure dependent peak shear strength. It was developed for applications involving roadbase soils by Lewis [1999] for the FHWA, who extended the work of Abbo and Sloan [1995] to include excess pore water effects.

Card 1	1	2	3	4	5	6	7	8
Variable	MID	RO	NPLOT	SPGRAV	RHOWAT	VN	GAMMAR	INTRMX
Type	A8	F	I	F	F	F	F	I
Default	none	none	1	none	1.0	0.0	0.0	1

Card 2	1	2	3	4	5	6	7	8
Variable	K	G	PHIMAX	AHYP	COH	ECCEN	AN	ET
Type	F	F	F	F	F	F		
Default	none	none	none	none	none	none	none	none

Card 3	1	2	3	4	5	6	7	8
Variable	MCONT	PWD1	PWKSK	PWD2	PHIRES	DINT	VDFM	DAMLEV
Type	F	F	F	F	F	F	F	F
Default	none	none	none	none	0.0	none	none	none

Card 4	1	2	3	4	5	6	7	8
Variable	EPSMAX							
Type	F							
Default	none							

VARIABLE**DESCRIPTION**

MID	Material identification. A unique number or label not exceeding 8 characters must be specified.
RO	Mass density
NPLOT	Controls what is written as component 7 to the d3plot database. LS-PrePost always blindly labels this component as effective plastic strain. EQ.1: Effective Strain EQ.2: Damage Criterion Threshold EQ.3: Damage (diso) EQ.4: Current Damage Criterion EQ.5: Pore Water Pressure EQ.6: Current Friction Angle (phi)
SPGRAV	Specific Gravity of Soil used to get porosity.
RHOWATt	Density of water in model units - used to determine air void strain (saturation)
VN	Viscoplasticity parameter (strain-rate enhanced strength)
GAMMAr	Viscoplasticity parameter (strain-rate enhanced strength)
ITERMAXx	Maximum number of plasticity iterations (default 1)
K	Bulk Modulus (non-zero)
G	Shear modulus (non-zero)
PHIMAX	Peak Shear Strength Angle (friction angle) (radians)

VARIABLE	DESCRIPTION
AHYP	Coefficient A for modified Drucker-Prager Surface
COH	Cohesion ñ Shear Strength at zero confinement (overburden)
ECCEN	Eccentricity parameter for third invariant effects
AN	Strain hardening percent of phi max where non-linear effects start
ET	Strain Hardening Amount of non-linear effects
MCONT	Moisture Content of Soil (Determines amount of air voids) (0.0 - 1.00)
PWD1	Parameter for pore water effects on bulk modulus
PWKSK	Skeleton bulk modulus- Pore water parameter ñ set to zero to eliminate effects
PWD2	Parameter for pore water effects on the effective pressure (confinement)
PHIRES	The minimum internal friction angle, radians (residual shear strength)
DINT	Volumetric Strain at Initial damage threshold, EMBED Equation.3
VDFM	Void formation energy (like fracture energy)
DAMLEV	Level of damage that will cause element deletion (0.0 - 1.00)
EPSMAX	Maximum principle failure strain

*MAT_FHWA_SOIL_NEBRASKA

This is an option to use the default properties determined for soils used at the University of Nebraska (Lincoln). The default units used for this material are millimeter, millisecond, and kilograms. If different units are desired, the conversion factors must be input.

This is Material Type 147. This is an isotropic material with damage and is available for solid elements. The model has a modified Mohr-Coulomb surface to determine the pressure dependent peak shear strength. It was developed for applications involving road base soils.

Card 1	1	2	3	4	5	6	7	8
Variable	MID	FCTIM	FCTMAS	FCTLEN				
Type	A8	F	I	F	F	F	F	I
Default	none	none	1	none	1.0	0.0	0.0	1

VARIABLE	DESCRIPTION
MID	Material identification. A unique number or label not exceeding 8 characters must be specified.
FCTIM	Factor to multiply milliseconds by to get desired time units
FCTMAS	Factor to multiply kilograms by to get desired mass units
FCTLEN	Factor to multiply millimeters by to get desired length units

Remarks:

1. As an example, if time units of seconds are desired, then $FCTIM = 0.001$

***MAT_GAS_MIXTURE**

This is Material Type 148. This model is for the simulation of thermally equilibrated ideal gas mixtures. This only works with the multi-material ALE formulation (ELFORM = 11 in *SECTION_SOLID). This keyword needs to be used together with *INITIAL_GAS_MIXTURE for the initialization of gas densities and temperatures. When applied in the context of ALE airbag modeling, the injection of inflator gas is done with a *SECTION_POINT_SOURCE_MIXTURE command which controls the injection process. This material model type also has its name start with *MAT_ALE_. For example, an identical material model to this is *MAT_ALE_GAS_MIXTURE (or also, *MAT_ALE_02).

Card 1	1	2	3	4	5	6	7	8
Variable	MID	IADIAB	RUNIV					
Type	A8	I	F					
Default	none	0	0.0					
Remark		5	1					

Card 2 for Per mass Calculation. Method (A) RUNIV = blank or 0.0.

Card 2	1	2	3	4	5	6	7	8
Variable	CVmass1	CVmass2	CVmass3	CVmass4	CVmass5	CVmass6	CVmass7	CVmass8
Type	F	F	F	F	F	F	F	F
Default	none	none	none	none	none	none	none	none

Card 3 for Per mass Calculation. Method (A) RUNIV = blank or 0.0.

Card 3	1	2	3	4	5	6	7	8
Variable	CPmass1	CPmass 2	CPmass 3	CPmass 4	CPmass 5	CPmass6	CPmass 7	CPmass 8
Type	F	F	F	F	F	F	F	F
Default	none	none	none	none	none	none	none	none

Card 2 for Per Mole Ccculation. Method (B) RUNIV is nonzero.

Card 2	1	2	3	4	5	6	7	8
Variable	MOLWT1	MOLWT2	MOLWT3	MOLWT4	MOLWT5	MOLWT6	MOLWT7	MOLWT8
Type	F	F	F	F	F	F	F	F
Default	none	none	none	none	none	none	none	none
Remark	2							

Card 3 for Per Mole Ccculation. Method (B) RUNIV is nonzero.

Card 3	1	2	3	4	5	6	7	8
Variable	CPmole1	CPmole2	CPmole3	CPmole4	CPmole5	CPmole6	CPmole7	CPmole8
Type	F	F	F	F	F	F	F	F
Default	none	none	none	none	none	none	none	none
Remark	2							

Card 4 for Per Mole Cclulation. Method (B) RUNIV is nonzero.

Card 4	1	2	3	4	5	6	7	8
Variable	B1	B2	B3	B4	B5	B6	B7	B8
Type	F	F	F	F	F	F	F	F
Default	none	none	none	none	none	none	none	none
Remark	2							

Card 5 for Per Mole Cclulation. Method (B) RUNIV is nonzero.

Card 5	1	2	3	4	5	6	7	8
Variable	C1	C2	C3	C4	C5	C6	C7	C8
Type	F	F	F	F	F	F	F	F
Default	none	none	none	none	none	none	none	none
Remark	2							

VARIABLE

DESCRIPTION

MID	Material identification. A unique number or label not exceeding 8 characters must be specified.
IADIAB	This flag (default = 0) is used to turn ON/OFF adiabatic compression logics for an ideal gas (remark 5). EQ.0: OFF (default) EQ.1: ON
RUNIV	Universal gas constant in per-mole unit (8.31447 J/(mole*K)).
CVmass1 - CVmass8	If RUNIV is BLANK or zero (method A): Heat capacity at constant volume for up to eight different gases in per-mass unit.

VARIABLE	DESCRIPTION
CPmass1 - CPmass8	If RUNIV is BLANK or zero (method A): Heat capacity at constant pressure for up to eight different gases in per-mass unit.
MOLWT1 - MOLWT8	If RUNIV is nonzero (method B): Molecular weight of each ideal gas in the mixture (mass-unit/mole).
CPmole1 - CPmole8	If RUNIV is nonzero (method B): Heat capacity at constant pressure for up to eight different gases in per-mole unit. These are nominal heat capacity values typically at STP. These are denoted by the variable "A" in the equation in remark 2.
B1 - B8	If RUNIV is nonzero (method B): First order coefficient for a temperature dependent heat capacity at constant pressure for up to eight different gases. These are denoted by the variable "B" in the equation in remark 2.
C1 - C8	If RUNIV is nonzero (method B): Second order coefficient for a temperature dependent heat capacity at constant pressure for up to eight different gases. These are denoted by the variable "C" in the equation in remark 2.

Remarks:

- There are 2 methods of defining the gas properties for the mixture. If RUNIV is BLANK or ZERO → Method (A) is used to define constant heat capacities where per-mass unit values of C_v and C_p are input. Only cards 2 and 3 are required for this method. Method (B) is used to define constant or temperature dependent heat capacities where per-mole unit values of C_p are input. Cards 2 - 5 are required for this method.

- The per-mass-unit, temperature-dependent, constant-pressure heat capacity is

$$C_p(T) = \frac{[CPmole + B \times T + C \times T^2]}{MOLWT}$$

Typical SI units

$C_p(T)$	CPmole	B	C
$\frac{J}{kg \ K}$	$\frac{J}{mole \ K}$	$\frac{J}{mole \ K^2}$	$\frac{J}{mole \ K^3}$

- The initial temperature and the density of the gas species present in a mesh or part at time zero is specified by the keyword *INITIAL_GAS_MIXTURE.

4. The ideal gas mixture is assumed to be thermal equilibrium, that is, all species are at the same temperature (T). The gases in the mixture are also assumed to follow Dalton's Partial Pressure Law, $P = \sum_i^{\text{ngas}} P_i$. The partial pressure of each gas is then $P_i = \rho_i R_{\text{gas}_i} T$ where $R_{\text{gas}_i} = \frac{R_{\text{univ}}}{MW}$. The individual gas species temperature equals the mixture temperature. The temperature is computed from the internal energy where the *mixture internal energy per unit volume* is used,

$$e_V = \sum_i^{\text{ngas}} \rho_i C_{V_i} T_i = \sum_i^{\text{ngas}} \rho_i C_{V_i} T$$

$$T = T_i = \frac{e_V}{\sum_i^{\text{ngas}} \rho_i C_{V_i}}$$

In general, the advection step conserves momentum and internal energy, but not kinetic energy. This can result in energy lost in the system and lead to a pressure drop. In *MAT_GAS_MIXTURE the dissipated kinetic energy is automatically converted into heat (internal energy). Thus in effect the total energy is conserved instead of conserving just the internal energy. This numerical scheme has been shown to improve accuracy in some cases. However, the user should always be vigilant and check the physics of the problem closely.

5. As an example consider an airbag surrounded by ambient air. As the inflator gas flows into the bag, the ALE elements cut by the airbag fabric shell elements will contain some inflator gas inside and some ambient air outside. The multi-material element treatment is not perfect. Consequently the temperature of the outside air may be made artificially high after the multi-material element treatment. To prevent the outside ambient air from getting artificially high T, set IDIAB = 1 for the ambient air outside. Simple adiabatic compression equation is then assumed for the outside air. The use of this flag may be needed, but only when that air is modeled by the *MAT_GAS_MIXTURE card.

Example:

Consider a tank test model where the Lagrangian tank (Part S1) is surrounded by an ALE air mesh (Part H4 = AMMGID 1). There are 2 ALE parts which are defined but initially have no corresponding mesh: part 5 (H5 = AMMGID 2) is the resident gas inside the tank at $t = 0$, and part 6 (H6 = AMMGID 2) is the inflator gas(es) which is injected into the tank when $t > 0$. AMMGID stands for ALE Multi-Material Group ID. Please see figure and input below. The *MAT_GAS_MIXTURE (MGM) card defines the gas properties of ALE parts H5 & H6. The MGM card input for both method (A) and (B) are shown.

The *INITIAL_GAS_MIXTURE card is also shown. It basically specifies that "AMMGID 2 may be present in part or mesh H4 at $t = 0$, and the initial density of this gas is defined in the rho1 position which corresponds to the 1st material in the mixture (or H5, the resident gas)."

Example configuration:

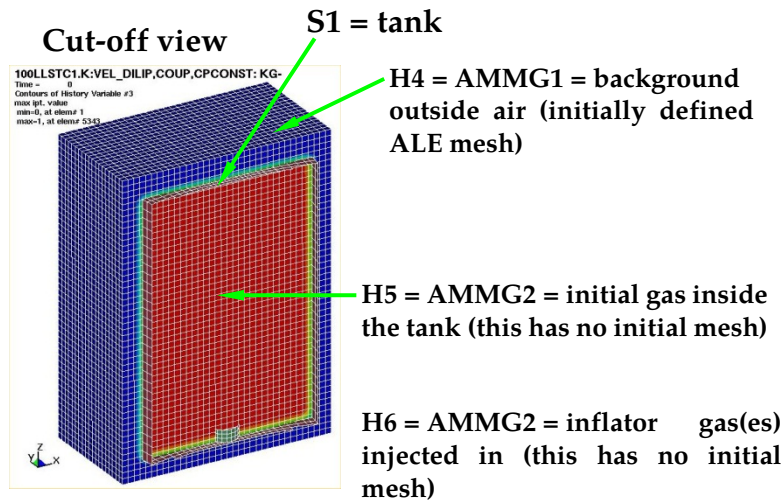

Sample input:

```

$-----
*PART
H5 = initial gas inside the tank
$      PID      SECID      MID      EOSID      HGID      GRAV      ADPOPT      TMID
$      5         5         5         0         5         0         0
*SECTION_SOLID
$      5         11         0
$-----
$ Example 1: Constant heat capacities using per-mass unit.
$*MAT_GAS_MIXTURE
$      MID      IADIAB      R_univ
$      5         0         0
$      Cv1_mas  Cv2_mas  Cv3_mas  Cv4_mas  Cv5_mas  Cv6_mas  Cv7_mas  Cv8_mas
$718.7828911237.56228
$      Cp1_mas  Cp2_mas  Cp3_mas  Cp4_mas  Cp5_mas  Cp6_mas  Cp7_mas  Cp8_mas
$1007.00058 1606.1117
$-----
$ Example 2: Variable heat capacities using per-mole unit.
$*MAT_GAS_MIXTURE
$      MID      IADIAB      R_univ
$      5         0      8.314470
$      MW1      MW2      MW3      MW4      MW5      MW6      MW7      MW8
$      0.0288479 0.02256
$      Cp1_mol  Cp2_mol  Cp3_mol  Cp4_mol  Cp5_mol  Cp6_mol  Cp7_mol  Cp8_mol
$29.049852 36.23388
$      B1      B2      B3      B4      B5      B6      B7      B8
$      7.056E-3 0.132E-1
$      C1      C2      C3      C4      C5      C6      C7      C8
$      -1.225E-6 -0.190E-5
$-----
$ One card is defined for each AMMG that will occupy some elements of a mesh set
*INITIAL_GAS_MIXTURE
$      SID      STYPE      MMGID      T0
$      4         1         1      298.15
$      RHO1      RHO2      RHO3      RHO4      RHO5      RHO6      RHO7      RHO8
$1.17913E-9
*INITIAL_GAS_MIXTURE
$      SID      STYPE      MMGID      T0
$      4         1         2      298.15

```

*MAT_148

*MAT_GAS_MIXTURE

\$	RHO1	RHO2	RHO3	RHO4	RHO5	RHO6	RHO7	RHO8
1.17913E-9								

***MAT_EMMI**

This is Material Type 151. The Evolving Microstructural Model of Inelasticity (EMMI) is a temperature and rate-dependent state variable model developed to represent the large deformation of metals under diverse loading conditions [Marin 2005]. This model is available for 3D solid elements, 2D solid elements and thick shell forms 3 and 5.

Card 1	1	2	3	4	5	6	7	8
Variable	MID	RHO	E	PR				
Type	A8	F	F	F				

Card 2	1	2	3	4	5	6	7	8
Variable	RGAS	BVECT	D0	QD	CV	ADRAG	BDRAG	DMTHTA
Type	F	F	F	F	F	F	F	F

Card 3	1	2	3	4	5	6	7	8
Variable	DMPHI	DNTHTA	DNPHI	THETA0	THETAM	BETA0	BTHETA	DMR
Type	F	F	F	F	F	F	F	F

Card 4	1	2	3	4	5	6	7	8
Variable	DNUC1	DNUC2	DNUC3	DNUC4	DM1	DM2	DM3	DM4
Type	F	F	F	F	F	F	F	F

Card 5	1	2	3	4	5	6	7	8
Variable	DM5	Q1ND	Q2ND	Q3ND	Q4ND	CALPHA	CKAPPA	C1
Type	F	F	F	F	F	F	F	F

Card 6	1	2	3	4	5	6	7	8
Variable	C2ND	C3	C4	C5	C6	C7ND	C8ND	C9ND
Type	F	F	F	F	F	F	F	F

Card 7	1	2	3	4	5	6	7	8
Variable	C10	A1	A2	A3	A4	A_XX	A_YY	A_ZZ
Type	F	F	F	F	F	F	F	F

Card 8	1	2	3	4	5	6	7	8
Variable	A_XY	A_YZ	A_XZ	ALPHXX	ALPHYY	ALPHZZ	ALPHXY	ALPHYZ
Type	F	F	F	F	F	F	F	F

Card 9	1	2	3	4	5	6	7	8
Variable	ALPHXZ	DKAPPA	PHIO	PHICR	DLBDAG	FACTOR	RSWTCH	DMGOPT
Type	F	F	F	F	F	F	F	F

Card 10	1	2	3	4	5	6	7	8
Variable	DELASO	DIMPLO	ATOL	RTOL	DINTER			
Type	F	F	F	F	F			

Leave this card blank (but include it!).

Card 11	1	2	3	4	5	6	7	8
Variable								
Type								

VARIABLE	DESCRIPTION
MID	Material identification. A unique number or label not exceeding 8 characters must be specified.
RHO	Material density.
E	Young's modulus
PR	Poisson's ratio
RGAS	universal gas constant.
BVECT	Burger's vector
D0	pre-exponential diffusivity coefficient
QD	activation energy
CV	specific heat at constant volume
ADRAG	drag intercept
BDRAG	drag coefficient
DMTHTA	shear modulus temperature coefficient
DMPHI	shear modulus damage coefficient
DNTHTA	bulk modulus temperature coefficient
DNPFI	bulk modulus damage coefficient
THETA0	reference temperature
THETAM	melt temperature
BETA0	coefficient of thermal expansion at reference temperature

VARIABLE	DESCRIPTION
BTHETA	thermal expansion temperature coefficient
DMR	damage rate sensitivity parameter
DNUC1	nucleation coefficient 1
DNUC2	nucleation coefficient 2
DNUC3	nucleation coefficient 3
DNUC4	nucleation coefficient 4
DM1	coefficient of yield temperature dependence
DM2	coefficient of yield temperature dependence
DM3	coefficient of yield temperature dependence
DM4	coefficient of yield temperature dependence
DM5	coefficient of yield temperature dependence
Q1ND	dimensionless activation energy for f
Q2ND	dimensionless activation energy for rd
Q3ND	dimensionless activation energy for Rd
Q4ND	dimensionless activation energy Rs
CALPHA	coefficient for backstress alpha
CKAPPA	coefficient for internal stress kappa
C1	parameter for flow rule exponent n
C2ND	parameter for transition rate f
C3	parameter for alpha dynamic recovery rd
C4	parameter for alpha hardening h
C5	parameter for kappa dynamic recovery Rd
C6	parameter for kappa hardening H
C7ND	parameter kappa static recovery Rs

VARIABLE	DESCRIPTION
C8ND	parameter for yield
C9ND	parameter for temperature dependence of flow rule exponent n
C10	parameter for static recovery (set = 1)
A1	plastic anisotropy parameter
A2	plastic anisotropy parameter
A3	plastic anisotropy parameter
A4	plastic anisotropy parameter
A_XX	initial structure tensor component
A_YY	initial structure tensor component
A_ZZ	initial structure tensor component
A_XY	initial structure tensor component
A_YZ	initial structure tensor component
A_XZ	initial structure tensor component
ALPHXX	initial backstress component
ALPHYY	initial backstress component
ALPHZZ	initial backstress component
ALPHXY	initial backstress component
ALPHYZ	initial backstress component
ALPHXZ	initial backstress component
DKAPPA	initial isotropic internal stress
PHI0	initial isotropic porosity
PHICR	critical cutoff porosity
DLBDAG	slip system geometry parameter
FACTOR	fraction of plastic work converted to heat, adiabatic

VARIABLE	DESCRIPTION
RSWTCH	rate sensitivity switch
DMGOPT	Damage model option parameter EQ.1.0: pressure independent Cocks/Ashby 1980 EQ.2.0: pressure dependent Cocks/Ashby 1980 EQ.3.0: pressure dependent Cocks 1989
DELASO	Temperature option EQ.0.0: driven externally EQ.1.0: adiabatic
DIMPLO	Implementation option flag EQ.1.0: combined viscous drag and thermally activated dislocation motion EQ.2.0: separate viscous drag and thermally activated dislocation motion
ATOL	absolute error tolerance for local Newton iteration
RTOL	relative error tolerance for local Newton iteration
DNITER	maximum number of iterations for local Newton iteration

Remarks:

$$\dot{\bar{\alpha}} = h \mathbf{d}^p - r_d \dot{\bar{\epsilon}}^p \bar{\alpha} \alpha$$

$$\dot{\kappa} = (H - R_d \kappa) \dot{\bar{\epsilon}}^p - R_s \kappa \sinh(Q_s \kappa)$$

$$\mathbf{d}^p = \sqrt{\frac{3}{2}} \dot{\bar{\epsilon}}^p \mathbf{n}, \dot{\bar{\epsilon}}^p = f \sinh^n \left[\left\langle \frac{\bar{\sigma}}{\kappa + Y} - 1 \right\rangle \right]$$

$\dot{\varepsilon}^p$ – equation	α – equation	κ – equation
$f = c_2 \exp\left(\frac{Q_1}{\theta}\right)$	$r_d = c_3 \exp\left(\frac{-Q_2}{\theta}\right)$	$R_d = c_5 \exp\left(\frac{-Q_3}{\theta}\right)$
$n = \frac{c_9}{\theta} - c_1$	$h = c_4 \hat{\mu}(\theta)$	$H = c_6 \hat{\mu}(\theta)$
$Y = c_8 \hat{Y}(\theta)$		$R_s = c_7 \exp\left(\frac{-Q_4}{\theta}\right)$
		$Q_s = c_{10} \exp\left(\frac{-Q_5}{\theta}\right)$

Table 2-83. Plasticity Material Functions of EMMI Model.

Void growth:

$$\dot{\varphi} = \frac{3}{\sqrt{2}} (1 - \varphi) \hat{G}(\bar{\sigma}_{eq}, \bar{p}, \varphi) \dot{\varepsilon}^p$$

$$\hat{G}(\bar{\sigma}_{eq}, \bar{p}, \varphi) = \frac{3}{\sqrt{3}} \left[\frac{1}{(1 - \varphi)m + 1} - 1 \right] \sinh \left[\frac{2(2m - 1) \langle \bar{p} \rangle}{2m + 1} \frac{1}{\bar{\sigma}_{eq}} \right]$$

***MAT_DAMAGE_3**

This is Material Type 153. This model has two back stress terms for kinematic hardening combined with isotropic hardening and a damage model for modeling low cycle fatigue and failure. Huang [2006] programmed this model and provided it as a user subroutine with the documentation that follows. It is available for beam, shell and solid elements.

Card 1	1	2	3	4	5	6	7	8
Variable	MID	RO	E	PR	SIGY	HARDI	BETA	LCSS
Type	A8	F	F	F	F	F	F	I

Card 2	1	2	3	4	5	6	7	8
Variable	HARDK1	GAMMA1	HARDK2	GAMMA2	SRC	SRP	HARDK3	GAMMA3
Type	F	F	F	F	F	F	F	F

Card 3	1	2	3	4	5	6	7	8
Variable	IDAM	IDS	IDEP	EPSD	S	T	DC	
Type	I	I	I	F	F	F	F	

VARIABLE**DESCRIPTION**

MID	Material identification. A unique number or label not exceeding 8 characters must be specified.
RO	Mass density, ρ
E	Young's modulus, E
PR	Poisson's ratio, ν
SIGY	Initial yield stress, σ_{y0} (ignored if LCSS.GT.0)
HARDI	Isotropic hardening modulus, H (ignored if LCSS.GT.0)

VARIABLE	DESCRIPTION
BETA	Isotropic hardening parameter, β . Set $\beta = 0$ for linear isotropic hardening. (Ignored if LCSS.GT.0 or if HARDI.EQ.0.)
LCSS	Load curve ID defining effective stress vs. effective plastic strain for isotropic hardening. The first abscissa value must be zero corresponding to the initial yield stress. The first ordinate value is the initial yield stress.
HARDK1	Kinematic hardening modulus C_1
GAMMA1	Kinematic hardening parameter γ_1 . Set $\gamma_1 = 0$ for linear kinematic hardening. Ignored if (HARDK1.EQ.0) is defined.
HARDK2	Kinematic hardening modulus C_2
GAMMA2	Kinematic hardening parameter γ_2 . Set $\gamma_2 = 0$ for linear kinematic hardening. Ignored if (HARDK2.EQ.0) is defined.
SRC	Strain rate parameter, C , for Cowper Symonds strain rate model, see below. If zero, rate effects are not considered.
SRP	Strain rate parameter, P , for Cowper Symonds strain rate model, see below. If zero, rate effects are not considered.
HARDK3	Kinematic hardening modulus C_3
GAMMA3	Kinematic hardening parameter γ_3 . Set $\gamma_3 = 0$ for linear kinematic hardening. Ignored if (HARDK3.EQ.0) is defined.
IDAM	Isotropic damage flag EQ.0: damage is inactivated. IDS, IDEP, EPSD, S, T, DC are ignored. EQ.1: damage is activated
IDS	Output stress flag EQ.0: undamaged stress is $\tilde{\sigma}$ output EQ.1: damaged stress is $\tilde{\sigma}(1 - D)$ output
IDEP	Damaged plastic strain EQ.0: plastic strain is accumulated $r = \int \dot{\epsilon}^{pl}$ EQ.1: damaged plastic strain is accumulated $r = \int (1 - D)\dot{\epsilon}^{pl}$

VARIABLE	DESCRIPTION
EPSD	Damage threshold r_d . Damage accumulation begins when $r > r_d$
S	Damage material constant S . Default = $\sigma_{y0}/200$
T	Damage material constant t . Default = 1
DC	Critical damage value D_c . When damage value reaches critical, the element is deleted from calculation. Default = 0.5

Remarks:

This model is based on the work of Lemaitre [1992], and Dufailly and Lemaitre [1995]. It is a pressure-independent plasticity model with the yield surface defined by the function

$$F = \bar{\sigma} - \sigma_y = 0$$

where σ_v is uniaxial yield stress

$$\sigma_y = \sigma_{y0} + \frac{H}{\beta} [1 - \exp(-\beta r)]$$

By setting $\beta = 0$, a linear isotropic hardening is obtained

$$\sigma_y = \sigma_{y0} + Hr$$

where σ_{v0} is the initial yield stress. And $\bar{\sigma}$ is the equivalent von Mises stress, with respect to the deviatoric effective stress

$$s_e = dev[\tilde{\sigma}] - \alpha = \mathbf{s} - \alpha$$

where \mathbf{s} is deviatoric stress and α is the back stress, which is decomposed into several components

$$\alpha = \sum_j \alpha_j$$

and $\tilde{\sigma}$ is effective stress (undamaged stress), based on Continuum Damage Mechanics model [Lemaitre 1992]

$$\tilde{\sigma} = \frac{\sigma}{1 - D}$$

where D is the isotropic damage scalar, which is bounded by 0 and 1

$$0 \leq D \leq 1$$

$D = 0$ represents a damage-free material RVE (representative volume element), while $D = 1$ represents a fully broken material RVE in two parts. In fact, fracture occurs when $D = D_c < 1$, modeled as element removal. The evolution of the isotropic damage value related to ductile damage and fracture (the case where the plastic strain or dissipation is much larger than the elastic one, [Lemaitre 1992]) is defined as

$$\dot{D} = \begin{cases} \left(\frac{Y}{S}\right)^t \dot{\epsilon}^{pl} & r > r_d \ \& \ \frac{\sigma_m}{\sigma_{eq}} > -\frac{1}{3} \\ 0 & \text{otherwise} \end{cases}$$

where $\frac{\sigma_m}{\sigma_{eq}}$ is the stress triaxiality, r_d is damage threshold, S is a material constant, and Y is strain energy density release rate.

$$Y = \frac{1}{2} \boldsymbol{\epsilon}^{el} : \mathbf{D}^{el} : \boldsymbol{\epsilon}^{el}$$

Where \mathbf{D}^{el} represents the fourth-order elasticity tensor, $\boldsymbol{\epsilon}^{el}$ is elastic strain. And t is a material constant, introduced by Dufailly and Lemaitre [1995], to provide additional degree of freedom for modeling low-cycle fatigue ($t = 1$ in Lemaitre [1992]). Dufailly and Lemaitre [1995] also proposed a simplified method to fit experimental results and get S and t .

The equivalent Mises stress is defined as

$$\bar{\sigma}(\mathbf{s}_e) = \sqrt{\frac{3}{2} \mathbf{s}_e : \mathbf{s}_e} = \sqrt{\frac{3}{2}} \|\mathbf{s}_e\|$$

The model assumes associated plastic flow

$$\dot{\boldsymbol{\epsilon}}^{pl} = \frac{\partial F}{\partial \boldsymbol{\sigma}} d\lambda = \frac{3 \mathbf{s}_e}{2 \bar{\sigma}} d\lambda$$

Where $d\lambda$ is the plastic consistency parameter. The evolution of the kinematic component of the model is defined as [Armstrong and Frederick 1966]:

$$\begin{cases} \dot{\boldsymbol{\alpha}}_j = \frac{2}{3} C_j \dot{\boldsymbol{\epsilon}}^{pl} - \gamma_j \boldsymbol{\alpha}_j \dot{\epsilon}^{pl} & \text{IDEP} = 0 \\ \dot{\boldsymbol{\alpha}}_j = (1 - D) \left(\frac{2}{3} C_j \dot{\boldsymbol{\epsilon}}^{pl} - \gamma_j \boldsymbol{\alpha}_j \dot{\epsilon}^{pl} \right) & \text{IDEP} = 1 \end{cases}$$

The damaged plastic strain is accumulated as

$$\begin{cases} r = \int \dot{\epsilon}^{pl} & \text{IDEP} = 0 \\ r = \int (1 - D) \dot{\epsilon}^{pl} & \text{IDEP} = 1 \end{cases}$$

where $\dot{\epsilon}^{pl}$ is the equivalent plastic strain rate

$$\dot{\epsilon}^{pl} = \sqrt{\frac{2}{3} \dot{\boldsymbol{\epsilon}}^{pl} : \dot{\boldsymbol{\epsilon}}^{pl}}$$

where $\dot{\boldsymbol{\epsilon}}^{pl}$ represents the rate of plastic flow.

Strain rate is accounted for using the Cowper and Symonds model which scales the yield stress with the factor

$$1 + \left(\frac{\dot{\epsilon}}{C}\right)^{1/p}$$

where $\dot{\epsilon}$ is the strain rate.

Table 153.1 shows the difference between MAT 153 and MAT 104/105. MAT 153 is less computationally expensive than MAT 104/105. Kinematic hardening, which already exists in MAT 103, is included in MAT 153, but not in MAT 104/105.

	MAT 153	MAT 104	MAT 105
Computational cost	1.0	3.0	3.0
Isotropic hardening	One component	Two components	One component
Kinematic hardening	Two components	N/A	N/A
Output stress	IDS = 0 $\Rightarrow \tilde{\sigma}$ IDS = 1 $\Rightarrow \tilde{\sigma}(1 - D)$	$\tilde{\sigma}(1 - D)$	$\tilde{\sigma}(1 - D)$
Damaged plastic strain	IDEP = 0 \Rightarrow $r = \int \dot{\epsilon}^{pl}$ IDEP = 1 \Rightarrow $r = \int (1 - D) \dot{\epsilon}^{pl}$	$r = \int (1 - D) \dot{\epsilon}^{pl}$	$r = \int (1 - D) \dot{\epsilon}^{pl}$
Accumulation when	$\frac{\sigma_m}{\sigma_{eq}} > -\frac{1}{3}$	$\sigma_1 > 0$	$\sigma_1 > 0$
Isotropic plasticity	Yes	Yes	Yes
Anisotropic plasticity	No	Yes	No
Isotropic damage	Yes	Yes	Yes
Anisotropic damage	No	Yes	No

Table 2-84. Differences between MAT 153 and MAT 104/105

***MAT_DESHPANDE_FLECK_FOAM**

This is material type 154 for solid elements. This material is for modeling aluminum foam used as a filler material in aluminum extrusions to enhance the energy absorbing capability of the extrusion. Such energy absorbers are used in vehicles to dissipate energy during impact. This model was developed by Reyes, Hopperstad, Berstad, and Langseth [2002] and is based on the foam model by Deshpande and Fleck [2000].

Card 1	1	2	3	4	5	6	7	8
Variable	MID	RHO	E	PR	ALPHA	GAMMA		
Type	A8	F	F	F	F	F		
Default	none	none	none	none	none	none		

Card 2	1	2	3	4	5	6	7	8
Variable	EPSD	ALPHA2	BETA	SIGP	DERFI	CFAIL	PFAIL	NUM
Type	F	F	F	F	F	F	F	F
Default	none	none	none	none	none	none	none	none

VARIABLE**DESCRIPTION**

MID	Material identification. A unique number or label not exceeding 8 characters must be specified.
RHO	Mass density.
E	Young's modulus.
PR	Poisson's ratio.
ALPHA	Controls shape of yield surface.
GAMMA	See remarks.
EPSD	Densification strain.

VARIABLE	DESCRIPTION
ALPHA2	See remarks.
BETA	See remarks.
SIGP	See remarks.
DERFI	Type of derivation used in material subroutine EQ.0: Numerical derivation EQ.1: Analytical derivation
CFAIL	Failure volumetric strain.
PFAIL	Failure principal stress. Must be sustained NUM (>0) timesteps to fail element.
NUM	Number of timesteps at or above PFAIL to trigger element failure.

Remarks:

The yield stress function Φ is defined by:

$$\Phi = \hat{\sigma} - \sigma_y$$

The equivalent stress $\hat{\sigma}$ is given by:

$$\hat{\sigma}^2 = \frac{\sigma_{VM}^2 + \alpha^2 \sigma_m^2}{1 + \left(\frac{\alpha}{3}\right)^2}$$

where, σ_{VM} , is the von Mises effective stress:

$$\sigma_{VM} = \sqrt{\frac{2}{3} \sigma^{dev} : \sigma^{dev}}$$

In this equation σ_m and σ^{dev} are the mean and deviatoric stress:

$$\sigma^{dev} = \sigma - \sigma_m \mathbf{I}$$

The yield stress σ_y can be expressed as:

$$\sigma_y = \sigma_p + \gamma \frac{\hat{\epsilon}}{\epsilon_D} + \alpha_2 \ln \left[\frac{1}{1 - \left(\frac{\hat{\epsilon}}{\epsilon_D}\right)^\beta} \right]$$

Here, σ_p , α_2 , γ and β are material parameters. The densification strain ϵ_D is defined as:

$$\epsilon_D = -\ln \left(\frac{\rho_f}{\rho_{f0}} \right)$$

where ρ_f is the foam density and ρ_{f0} is the density of the virgin material.

***MAT_PLASTICITY_COMPRESSION_TENSION_EOS**

This is Material Type 155. An isotropic elastic-plastic material where unique yield stress versus plastic strain curves can be defined for compression and tension. Also, failure can occur based on a plastic strain or a minimum time step size. Rate effects on the yield stress are modeled either by using the Cowper-Symonds strain rate model or by using two load curves that scale the yield stress values in compression and tension, respectively. Material rate effects, which are independent of the plasticity model, are based on a 6-term Prony series Maxwell mode that generates an additional stress tensor. The viscous stress tensor is superimposed on the stress tensor generated by the plasticity. Pressure is defined by an equation of state, which is required to utilize this model. This model is applicable to solid elements and SPH.

Card 1	1	2	3	4	5	6	7	8
Variable	MID	RO	E	PR	C	P	FAIL	TDEL
Type	A8	F	F	F	F	F	F	F
Default	none	none	none	none	0	0	10.E+20	0

Card 2	1	2	3	4	5	6	7	8
Variable	LCIDC	LCIDT	LCSRC	LCSRT	SRFLAG			
Type	I	I	I	I	F			
Default	0	0	0	0	0			

Card 3	1	2	3	4	5	6	7	8
Variable	PC	PT	PCUTC	PCUTT	PCUTF	SCALEP	SCALEE	
Type	F	F	F	F	F	F	F	
Default	0	0	0	0	0	0	0	

Card 4	1	2	3	4	5	6	7	8
Variable	K							
Type	F							

Viscoelastic Constant Cards. Card Format for viscoelastic constants. Up to 6 cards may be input. A keyword card (with a "*" in column 1) terminates this input if less than 6 cards are used.

Optional	1	2	3	4	5	6	7	8
Variable	GI	BETA1						
Type	F	F						

VARIABLE	DESCRIPTION
MID	Material identification. A unique number or label not exceeding 8 characters must be specified.
RO	Mass density.
E	Young's modulus.
PR	Poisson's ratio.
C	Strain rate parameter, C, see formula below.
P	Strain rate parameter, P, see formula below.
FAIL	Failure flag. LT.0.0: User defined failure subroutine, matusr_24 in dyn21.F, is called to determine failure EQ.0.0: Failure is not considered. This option is recommended if failure is not of interest since many calculations will be saved. GT.0.0: Plastic strain to failure. When the plastic strain reaches this value, the element is deleted from the calculation.
TDEL	Minimum time step size for automatic element deletion.

VARIABLE	DESCRIPTION
LCIDC	Load curve ID defining yield stress versus effective plastic strain in compression.
LCIDT	Load curve ID defining yield stress versus effective plastic strain in tension.
LCSRC	Optional load curve ID defining strain rate scaling effect on yield stress when the material is in compression.
LCSRT	Optional load curve ID defining strain rate scaling effect on yield stress when the material is in tension.
SRFLAG	Formulation for rate effects: EQ.0.0: Total strain rate, EQ.1.0: Deviatoric strain rate.
PC	Compressive mean stress (pressure) at which the yield stress follows load curve ID, LCIDC. If the pressure falls between PC and PT a weighted average of the two load curves is used.
PT	Tensile mean stress at which the yield stress follows load curve ID, LCIDT.
PCUTC	Pressure cut-off in compression. When the pressure cut-off is reached the deviatoric stress tensor is set to zero. The compressive pressure is not, however, limited to PCUTC. Like the yield stress, PCUTC is scaled to account for rate effects.
PCUTT	Pressure cut-off in tension. When the pressure cut-off is reached the deviatoric stress tensor and tensile pressure is set to zero. Like the yield stress, PCUTT is scaled to account for rate effects.
PCUTF	Pressure cut-off flag. EQ.0.0: Inactive, EQ.1.0: Active.
SCALEP	Scale factor applied to the yield stress after the pressure cut-off is reached in either compression or tension. If SCALEP = 0 (default), the deviatoric stress is set to zero after the cut-off is reached.

VARIABLE	DESCRIPTION
SCALEE	Scale factor applied to the yield stress after the strain exceeds the failure strain set by FAIL. If SCALEE = 0 (default), the deviatoric strain is set to zero if the failure strain is exceeded. IF both SCALEP > 0 and SCALEE > 0 and both failure conditions are met, then the minimum scale factor is used.
K	Optional bulk modulus for the viscoelastic material. If nonzero a Kelvin type behavior will be obtained. Generally, K is set to zero.
GI	Optional shear relaxation modulus for the ith term
BETAI	Optional shear decay constant for the ith term

Remarks:

The stress strain behavior follows a different curve in compression than it does in tension. Tension is determined by the sign of the mean stress where a positive mean stress (i.e., a negative pressure) is indicative of tension. Two curves must be defined giving the yield stress versus effective plastic strain for both the tension and compression regimes.

Mean stress is an invariant which can be expressed as $(\sigma_x + \sigma_y + \sigma_z)/3$. PC and PT define a range of mean stress values within which interpolation is done between the tensile yield surface and compressive yield surface. PC and PT are not true material properties but are just a numerical convenience so that the transition from one yield surface to the other is not abrupt as the sign of the mean stress changes. Both PC and PT are input as positive values as it is implied that PC is a compressive mean stress value and PT is tensile mean stress value.

Strain rate may be accounted for using the Cowper and Symonds model which scales the yield stress with the factor:

$$1 + \left(\frac{\dot{\epsilon}}{C}\right)^{1/p}$$

where $\dot{\epsilon}$ is the strain rate,

$$\dot{\epsilon} = \sqrt{\dot{\epsilon}_{ij}\dot{\epsilon}_{ij}}$$

History Variables:

History Variable	Description
4	Tensile pressure cutoff (set to zero if tensile or compressive failure occurs)
5	The cutoff flag, initially equals 1, set to 0 if tensile or compressive failure occurs
6	The failure mode flag EQ.0: if no failure EQ.1: if compressive failure EQ.2: if tensile failure EQ.3: if failure by plastic strain
7	The current flow stress

*MAT_MUSCLE

This is material type 156 for truss elements. This material is a Hill-type muscle model with activation and a parallel damper. Also, see *MAT_SPRING_MUSCLE where a description of the theory is available.

Card 1	1	2	3	4	5	6	7	8
Variable	MID	RO	SNO	SRM	PIS	SSM	CER	DMP
Type	A8	F	F	F	F	F	F	F
Default								

Card 2	1	2	3	4	5	6	7	8
Variable	ALM	SFR	SVS	SVR	SSP			
Type	F	F	F	F	F			
Default	0.0	1.0	1.0	1.0	0.0			

VARIABLE**DESCRIPTION**

MID	Material identification. A unique number or label not exceeding 8 characters must be specified.
RO	Material density in the initial undeformed configuration.
SNO	Initial stretch ratio, $\frac{l_0}{l_{orig}}$, i.e., the length as defined by the nodal points at $t = 0$ divided by the original initial length. The density for the nodal mass calculation is RO/SNO , or $\frac{l_{orig}\rho}{l_0}$.
SRM	Maximum strain rate.
PIS	Peak isometric stress corresponding to the dimensionless value of unity in the dimensionless stress versus strain function, see SSP below.

VARIABLE	DESCRIPTION
SSM	Strain when the dimensionless stress versus strain function, SSP below, reaches its maximum stress value.
CER	Constant, governing the exponential rise of SSP. Required if SSP = 0.
DMP	Damping constant.
ALM	Activation level vs. time. LT.0: absolute value gives load curve ID GE.0: constant value of ALM is used
SFR	Scale factor for strain rate maximum vs. the stretch ratio, $\frac{l}{l_{orig}}$. LT.0: absolute value gives load curve ID GE.0: constant value of 1.0 is used
SVS	Active dimensionless tensile stress vs. the stretch ratio, $\frac{l}{l_{orig}}$. LT.0: absolute value gives load curve ID GE.0: constant value of 1.0 is used
SVR	Active dimensionless tensile stress vs. the normalized strain rate, $\dot{\epsilon}$. LT.0: absolute value gives load curve ID GE.0: constant value of 1.0 is used
SSP	Isometric dimensionless stress vs. the stretch ratio, $\frac{l}{l_{orig}}$ for the parallel elastic element. LT.0: absolute value gives load curve ID or table ID (see below) EQ.0: exponential function is used (see below) GT.0: constant value of 0.0 is used

Remarks:

The material behavior of the muscle model is adapted from *MAT_S15, the spring muscle model and treated here as a standard material. The initial length of muscle is calculated automatically. The force, relative length and shortening velocity are replaced by stress, strain and strain rate. A new parallel damping element is added.

The strain ε and normalized strain rate $\dot{\varepsilon}$ are defined respectively as

$$\begin{aligned}\varepsilon &= \frac{l}{l_{\text{orig}}} - 1 \\ &= \text{SNO} \times \frac{l}{l_0} - 1\end{aligned}$$

and,

$$\begin{aligned}\dot{\varepsilon} &= \frac{l}{l_{\text{orig}}} \frac{\dot{\varepsilon}}{\dot{\varepsilon}_{\text{max}}} \\ &= \text{SNO} \times \frac{l}{l_0} \frac{\dot{\varepsilon}}{\text{SFR} \times \text{SRM}}\end{aligned}$$

where $\dot{\varepsilon} = \Delta l / \Delta t$ (current length change divided by current time step), l = current muscle length, and l_{orig} = original muscle length.

From the relation above, it is known:

$$l_{\text{orig}} = \frac{l_0}{1 + \varepsilon_0}$$

where $\varepsilon_0 = \text{SNO} - 1$ and l_0 = muscle length at time 0.

Stress of Contractile Element is:

$$\sigma_1 = \sigma_{\text{max}} a(t) f\left(\frac{l}{l_{\text{orig}}}\right) g(\dot{\varepsilon})$$

where $\sigma_{\text{max}} = \text{PIS}$, $a(t) = \text{ALM}$, $f(l/l_{\text{orig}}) = \text{SVS}$, and $g(\dot{\varepsilon}) = \text{SVR}$.

Stress of Passive Element is:

$$\sigma_2 = \begin{cases} \sigma_{\text{max}} h\left(\frac{l}{l_{\text{orig}}}\right) & \text{for curve} \\ \sigma_{\text{max}} h\left(\dot{\varepsilon}, \frac{l}{l_{\text{orig}}}\right) & \text{for table} \end{cases}$$

where $h = \text{SSP}$. For $\text{SSP} < 0$, the absolute value gives a load curve ID or table ID. The load curve defines isometric dimensionless stress h versus stretch ratio l/l_{orig} . The table defines for each normalized strain rate $\dot{\varepsilon}$ a load curve giving the isometric dimensionless stress h versus stretch ratio l/l_{orig} for that rate.

For exponential relationship ($\text{SSP} = 0$):

$$h(1/l_{orig}) = \begin{cases} 0 & 1/l_{orig} < 1 \\ \frac{1}{\exp(\text{CER}) - 1} \left[\exp\left(\frac{\text{CER}}{\text{SSM}} \varepsilon\right) - 1 \right] & 1/l_{orig} \geq 1 \quad \text{CER} \neq 0 \\ \frac{\varepsilon}{\text{SSM}} & 1/l_{orig} \geq 1 \quad \text{CER} = 0 \end{cases}$$

Stress of Damping Element is:

$$\sigma_3 = \text{DMP} \times \frac{l}{l_{orig}} \dot{\varepsilon}$$

Total Stress is:

$$\sigma = \sigma_1 + \sigma_2 + \sigma_3$$

***MAT_ANISOTROPIC_ELASTIC_PLASTIC**

This is Material Type 157. This material model is a combination of the anisotropic elastic material model (MAT_002) and the anisotropic plastic material model (MAT_103_P).

Card 1	1	2	3	4	5	6	7	8
Variable	MID	R0	SIGY	LCSS	QR1	CR1	QR2	CR2
Type	A8	F	F	F	F	F	F	F

Card 2	1	2	3	4	5	6	7	8
Variable	C11	C12	C13	C14	C15	C16	C22	C23
Type	F	F	F	F	F	F	F	F

Card 3	1	2	3	4	5	6	7	8
Variable	C24	C25	C26	C33	C34	C35	C36	C44
Type	F	F	F	F	F	F	F	F

Card 4	1	2	3	4	5	6	7	8
Variable	C45	C46	C55	C56	C66	R00	R45	R90
Type	F	F	F	F	F	F	F	F

Card 5	1	2	3	4	5	6	7	8
Variable	S11	S22	S33	S12	AOPT	VP		
Type	F	F	F	F	F	F		

Card 6	1	2	3	4	5	6	7	8
Variable	Not used	Not used	Not used	A1	A2	A3		
Type				F	F	F		

Card 7	1	2	3	4	5	6	7	8
Variable	V1	V2	V3	D1	D2	D3	BETA	
Type	F	F	F	F	F	F	F	

VARIABLE**DESCRIPTION**

MID	Material identification. A unique number or label not exceeding 8 characters must be specified.
RO	Mass density.
SIGY	Initial yield stress
LCSS	Load curve ID or Table ID. The load curve ID defines effective stress versus effective plastic strain. QR1, CR1, QR2, and CR2 are ignored with this option. The Table ID defines for each strain rate value a load curve ID giving effective stress versus effective plastic strain for that rate.
QR1	Isotropic hardening parameter $Qr1$
CR1	Isotropic hardening parameter $Cr1$
QR2	Isotropic hardening parameter $Qr2$
CR2	Isotropic hardening parameter $Cr2$
CIJ	The I, J term in the 6×6 anisotropic constitutive matrix. Note that 1 corresponds to the a material direction, 2 to the b material direction, and 3 to the c material direction.
R00	R_{00} for shell (Default = 1.0)
R45	R_{45} for shell (Default = 1.0)

VARIABLE	DESCRIPTION
R90	R_{90} for shell (Default = 1.0)
S11	Yield stress in local-x direction. This input is ignored if $(R00, R45, R90) > 0$.
S22	Yield stress in local-y direction. This input is ignored if $(R00, R45, R90) > 0$.
S33	Yield stress in local-z direction. This input is ignored if $(R00, R45, R90) > 0$.
S12	Yield stress in local-xy direction. This input is ignored if $(R00, R45, R90) > 0$.
AOPT	Material axes option (see MAT_OPTIONTROPIC_ELASTIC for a more complete description. <p>EQ.0.0: locally orthotropic with material axes determined by element nodes as shown in Figure 2-3, and then rotated about the shell element normal by the angle BETA. Nodes 1, 2, and 4 of an element are identical to the nodes used for the definition of a coordinate system as by *DEFINE_COORDINATE_NODES.</p> <p>EQ.2.0: globally orthotropic with material axes determined by vectors defined below, as with *DEFINE_COORDINATE_VECTOR.</p> <p>EQ.3.0: locally orthotropic material axes determined by rotating the material axes about the element normal by an angle, BETA, from a line in the plane of the element defined by the cross product of the vector v with the element normal.</p> <p>LT.0.0: the absolute value of AOPT is a coordinate system ID number (CID on *DEFINE_COORDINATE_NODES, *DEFINE_COORDINATE_SYSTEM or *DEFINE_COORDINATE_VECTOR). Available in R3 version of 971 and later.</p>
VP	Formulation for rate effects: <p>EQ.0.0: scale yield stress (default),</p> <p>EQ.1.0: viscoplastic formulation.</p>

VARIABLE	DESCRIPTION
A1, A2, A3	a1, a2, a3 define components of vector a for AOPT = 2.
D1, D2, D3	d1, d2, d3 define components of vector d for AOPT = 2.
V1, V2, V3	v1, v2, v3 define components of vector v for AOPT = 3 and 4.
BETA	Material angle in degrees for AOPT = 0 and 3, may be overwritten on the element card, see *ELEMENT_SHELL_BETA.

***MAT_RATE_SENSITIVE_COMPOSITE_FABRIC**

This is Material Type 158. Depending on the type of failure surface, this model may be used to model rate sensitive composite materials with unidirectional layers, complete laminates, and woven fabrics. A viscous stress tensor, based on an isotropic Maxwell model with up to six terms in the Prony series expansion, is superimposed on the rate independent stress tensor of the composite fabric. The viscous stress tensor approach should work reasonably well if the stress increases due to rate effects are up to 15% of the total stress. This model is implemented for both shell and thick shell elements. The viscous stress tensor is effective at eliminating spurious stress oscillations.

Card 1	1	2	3	4	5	6	7	8
Variable	MID	RO	EA	EB	(EC)	PRBA	TAU1	GAMMA1
Type	A8	F	F	F	F	F	F	F

Card 2	1	2	3	4	5	6	7	8
Variable	GAB	GBC	GCA	SLIMT1	SLIMC1	SLIMT2	SLIMC2	SLIMS
Type	F	F	F	F	F	F	F	F

Card 3	1	2	3	4	5	6	7	8
Variable	AOPT	TSIZE	ERODS	SOFT	FS			
Type	F	F	F	F	F			

Card 4	1	2	3	4	5	6	7	8
Variable	XP	YP	ZP	A1	A2	A3		
Type	F	F	F	F	F	F		

MAT_158**MAT_RATE_SENSITIVE_COMPOSITE_FABRIC**

Card 5	1	2	3	4	5	6	7	8
Variable	V1	V2	V3	D1	D2	D3	BETA	
Type	F	F	F	F	F	F	F	

Card 6	1	2	3	4	5	6	7	8
Variable	E11C	E11T	E22C	E22T	GMS			
Type	F	F	F	F	F			

Card 7	1	2	3	4	5	6	7	8
Variable	XC	XT	YC	YT	SC			
Type	F	F	F	F	F			

Card 8	1	2	3	4	5	6	7	8
Variable	K							
Type	F							

Viscoelastic Cards. Up to 6 cards may be input. A keyword card (with a "*" in column 1) terminates this input if less than 6 cards are used.

Optional	1	2	3	4	5	6	7	8
Variable	GI	BETA1						
Type	F	F						

VARIABLE	DESCRIPTION
MID	Material identification. A unique number or label not exceeding 8 characters must be specified.
RO	Mass density
EA	E_a , Young's modulus - longitudinal direction
EB	E_b , Young's modulus - transverse direction
(EC)	E_c , Young's modulus - normal direction (not used)
PRBA	ν_{ba} , Poisson's ratio ba
TAU1	τ_1 , stress limit of the first slightly nonlinear part of the shear stress versus shear strain curve. The values τ_1 and γ_1 are used to define a curve of shear stress versus shear strain. These values are input if FS, defined below, is set to a value of -1.
GAMMA1	γ_1 , strain limit of the first slightly nonlinear part of the shear stress versus shear strain curve.
GAB	G_{ab} , shear modulus ab
GBC	G_{bc} , shear modulus bc
GCA	G_{ca} , shear modulus ca
SLIMT1	Factor to determine the minimum stress limit after stress maximum (fiber tension).
SLIMC1	Factor to determine the minimum stress limit after stress maximum (fiber compression).
SLIMT2	Factor to determine the minimum stress limit after stress maximum (matrix tension).
SLIMC2	Factor to determine the minimum stress limit after stress maximum (matrix compression).
SLIMS	Factor to determine the minimum stress limit after stress maximum (shear).
AOPT	Material axes option (see MAT_OPTIONTROPIC_ELASTIC for a more complete description): EQ.0.0: locally orthotropic with material axes determined by el-

VARIABLE	DESCRIPTION
	<p>ement nodes 1, 2, and 4, as with *DEFINE_COORDINATE_NODES, and then rotated about the shell element normal by the angle BETA.</p> <p>EQ.2.0: globally orthotropic with material axes determined by vectors defined below, as with *DEFINE_COORDINATE_VECTOR.</p> <p>EQ.3.0: locally orthotropic material axes determined by rotating the material axes about the element normal by an angle (BETA) from a line in the plane of the element defined by the cross product of the vector v with the element normal.</p> <p>LT.0.0: the absolute value of AOPT is a coordinate system ID number (CID on *DEFINE_COORDINATE_NODES, *DEFINE_COORDINATE_SYSTEM or *DEFINE_COORDINATE_VECTOR). Available in R3 version of 971 and later.</p>
TSIZE	Time step for automatic element deletion.
ERODS	Maximum effective strain for element layer failure. A value of unity would equal 100% strain.
SOFT	Softening reduction factor for strength in the crashfront.
FS	<p>Failure surface type:</p> <p>EQ.1.0: smooth failure surface with a quadratic criterion for both the fiber (a) and transverse (b) directions. This option can be used with complete laminates and fabrics.</p> <p>EQ.0.0: smooth failure surface in the transverse (b) direction with a limiting value in the fiber (a) direction. This model is appropriate for unidirectional (UD) layered composites only.</p> <p>EQ.-1: faceted failure surface. When the strength values are reached then damage evolves in tension and compression for both the fiber and transverse direction. Shear behavior is also considered. This option can be used with complete laminates and fabrics.</p>
XP, YP, ZP	Define coordinates of point p for AOPT = 1.
A1, A2, A3	Define components of vector a for AOPT = 2.

VARIABLE	DESCRIPTION
V1, V2, V3	Define components of vector v for AOPT = 3.
D1, D2, D3	Define components of vector d for AOPT = 2.
BETA	Material angle in degrees for AOPT = 0 and 3, may be overridden on the element card, see *ELEMENT_SHELL_BETA.
E11C	Strain at longitudinal compressive strength, a-axis.
E11T	Strain at longitudinal tensile strength, a-axis.
E22C	Strain at transverse compressive strength, b-axis.
E22T	Strain at transverse tensile strength, b-axis.
GMS	Strain at shear strength, ab plane.
XC	Longitudinal compressive strength
XT	Longitudinal tensile strength, see below.
YC	Transverse compressive strength, b-axis, see below.
YT	Transverse tensile strength, b-axis, see below.
SC	Shear strength, ab plane.
K	Optional bulk modulus for the viscoelastic material. If nonzero a Kelvin type behavior will be obtained. Generally, K is set to zero.
GI	Optional shear relaxation modulus for the ith term
BETAI	Optional shear decay constant for the ith term

Remarks:

See the remark for material type 58, *MAT_LAMINATED_COMPOSITE_FABRIC, for the treatment of the composite material.

Rate effects are taken into account through a Maxwell model using linear viscoelasticity by a convolution integral of the form:

$$\sigma_{ij} = \int_0^t g_{ijkl}(t - \tau) \frac{\partial \varepsilon_{kl}}{\partial \tau} d\tau$$

where $g_{ijkl}(t-\tau)$ is the relaxation functions for the different stress measures. This stress is added to the stress tensor determined from the strain energy functional. Since we wish to include only simple rate effects, the relaxation function is represented by six terms from the Prony series:

$$g(t) = \sum_{m=1}^N G_m e^{-\beta_m t}$$

We characterize this in the input by the shear moduli, G_i , and decay constants, β_i . An arbitrary number of terms, not exceeding 6, may be used when applying the viscoelastic model. The composite failure is not directly affected by the presence of the viscous stress tensor.

***MAT_CSCM_{OPTION}**

This is material type 159. This is a smooth or continuous surface cap model and is available for solid elements in LS-DYNA. The user has the option of inputting his own material properties (<BLANK> option), or requesting default material properties for normal strength concrete (CONCRETE).

Available options include:

<BLANK>

CONCRETE

Card 1	1	2	3	4	5	6	7	8
Variable	MID	RO	NPLOT	INCRE	IRATE	ERODE	RECOV	ITRETRC
Type	A8	F	I	F	I	F	F	I

Card 2	1	2	3	4	5	6	7	8
Variable	PRED							
Type	F							

Card 3 for CONCRETE keyword option.

Card 3	1	2	3	4	5	6	7	8
Variable	FPC	DAGG	UNITS					
Type	F	F	I					

The remaining cards are read when the keyword option is left *blank*. They are *not* read in when CONCRETE keyword option is active.

Card 3	1	2	3	4	5	6	7	8
Variable	G	K	ALPHA	THETA	LAMDA	BETA	NH	CH
Type	F	F	F	F	F	F	F	F

Card 4	1	2	3	4	5	6	7	8
Variable	ALPHA1	THETA1	LAMDA1	BETA1	ALPHA2	THETA2	LAMDA2	BETA2
Type	F	F	F	F	F	F	F	F

Card 5	1	2	3	4	5	6	7	8
Variable	R	X0	W	D1	D2			
Type	F	F	F	F	F			

Card 6	1	2	3	4	5	6	7	8
Variable	B	GFC	D	GFT	GFS	PWRC	PWRT	PMOD
Type	F	F	F	F	F	F	F	F

Card 7	1	2	3	4	5	6	7	8
Variable	ETA0C	NC	ETA0T	NT	OVERC	OVERT	SRATE	REPOW
Type	F	F	F	F	F	F	F	F

VARIABLE	DESCRIPTION
MID	Material identification. A unique number or label not exceeding 8 characters must be specified.
RO	Mass density.
NPLOT	Controls what is written as component 7 to the d3plot database. LS-Prepost always blindly labels this component as effective plastic strain: EQ.1: Maximum of brittle and ductile damage (default). EQ.2: Maximum of brittle and ductile damage, with recovery of brittle damage. EQ.3: Brittle damage. EQ.4: Ductile damage. EQ.5: κ (intersection of cap with shear surface). EQ.6: X0 (intersection of cap with pressure axis). EQ.7: ε_v^p (plastic volume strain).
INCRE	Maximum strain increment for subincrementation. If left blank, a default value is set during initialization based upon the shear strength and stiffness.
IRATE	Rate effects options: EQ.0: Rate effects model turned off (default). EQ.1: Rate effects model turned on.
ERODE	Elements erode when damage exceeds 0.99 and the maximum principal strain exceeds ERODE-1.0. For erosion that is independent of strain, set ERODE equal to 1.0. Erosion does not occur if ERODE is less than 1.0.

VARIABLE	DESCRIPTION
RECOV	<p>The modulus is recovered in compression when RECOV is equal to 0 (default). The modulus remains at the brittle damage level when RECOV is equal to 1. Partial recovery is modeled for values of RECOV between 0 and 1. Two options are available:</p> <p>EQ.1: Input a value between 0 and 1. Recovery is based upon the sign of the pressure invariant only.</p> <p>EQ.2: Input a value between 10 and 11. Recovery is based upon the sign of both the pressure and volumetric strain. In this case, RECOV = RECOV-10, and a flag is set to request the volumetric strain check.</p>
IRETRC	<p>Cap retraction option:</p> <p>EQ.0: Cap does not retract (default).</p> <p>EQ.1: Cap retracts.</p>
PRED	<p>Pre-existing damage ($0 \leq \text{PreD} < 1$). If left blank, the default is zero (no pre-existing damage).</p>

Define for the concrete option:

Note that the default concrete input parameters are for normal strength concrete with unconfined compression strengths between about 28 and 58 MPa.

VARIABLE	DESCRIPTION
FPC	<p>Unconfined compression strength, f'_c. If left blank, default is 30 MPa.</p>
DAGG	<p>Maximum aggregate size, D_{agg}. If left blank, default is 19 mm (3/4 inch).</p>
UNITS	<p>Units options:</p> <p>EQ.0: GPa, mm, msec, Kg/mm³, kN</p> <p>EQ.1: MPa, mm, msec, g/mm³, N</p> <p>EQ.2: MPa, mm, sec, Mg/mm³, N</p> <p>EQ.3: Psi, inch, sec, lbf-s²/inch⁴, lbf</p> <p>EQ.4: Pa, m, sec, kg/m³, N</p>

Define for <BLANK> option only:

VARIABLE	DESCRIPTION
G	Shear modulus.
K	Bulk modulus.
ALPHA	Tri-axial compression surface constant term, α .
THETA	Tri-axial compression surface linear term, θ .
LAMDA	Tri-axial compression surface nonlinear term, λ .
BETA	Tri-axial compression surface exponent, β .
ALPHA1	Torsion surface constant term, α_1 .
THETA1	Torsion surface linear term, θ_1 .
LAMDA1	Torsion surface nonlinear term, λ_1 .
BETA1	Torsion surface exponent, β_1 .
ALPHA2	Tri-axial extension surface constant term, α_2 .
THETA2	Tri-axial extension surface linear term, θ_2 .
LAMDA2	Tri-axial extension surface nonlinear term, λ_2 .
BETA2	Tri-axial extension surface exponent, β_2 .
NH	Hardening initiation, N_H .
CH	Hardening rate, C_H .
R	Cap aspect ratio, R .
X0	Cap initial location, X_0 .
W	Maximum plastic volume compaction, W .
D1	Linear shape parameter, D_1 .
D2	Quadratic shape parameter, D_2 .
B	Ductile shape softening parameter, B .

VARIABLE	DESCRIPTION
GFC	Fracture energy in uniaxial stress G_{fc} .
D	Brittle shape softening parameter, D.
GFT	Fracture energy in uniaxial tension, G_{ft} .
GFS	Fracture energy in pure shear stress, G_{fs} .
PWRC	Shear-to-compression transition parameter.
PWRT	Shear-to-tension transition parameter.
PMOD	Modify moderate pressure softening parameter.
ETA0C	Rate effects parameter for uniaxial compressive stress, η_{0c} .
NC	Rate effects power for uniaxial compressive stress, N_c .
ETA0T	Rate effects parameter for uniaxial tensile stress, η_{0t} .
NT	Rate effects power for uniaxial tensile stress, N_t .
OVERC	Maximum overstress allowed in compression.
OVERT	Maximum overstress allowed in tension.
SRATE	Ratio of effective shear stress to tensile stress fluidity parameters.
REPOW	Power which increases fracture energy with rate effects.

Model Formulation and Input Parameters:

This is a cap model with a smooth intersection between the shear yield surface and hardening cap, as shown in [Figure 2-85](#). The initial damage surface coincides with the yield surface. Rate effects are modeled with viscoplasticity. For a complete theoretical description, with references and example problems see [Murray 2007] and [Murray, Abu-Odeh and Bligh 2007].

Stress Invariants. The yield surface is formulated in terms of three stress invariants: J_1 is the first invariant of the stress tensor, J_2' is the second invariant of the deviatoric stress tensor, and J_3' is the third invariant of the deviatoric stress tensor. The invariants are defined in terms of the deviatoric stress tensor, S_{ij} and pressure, P , as follows:

$$J_1 = 3P$$

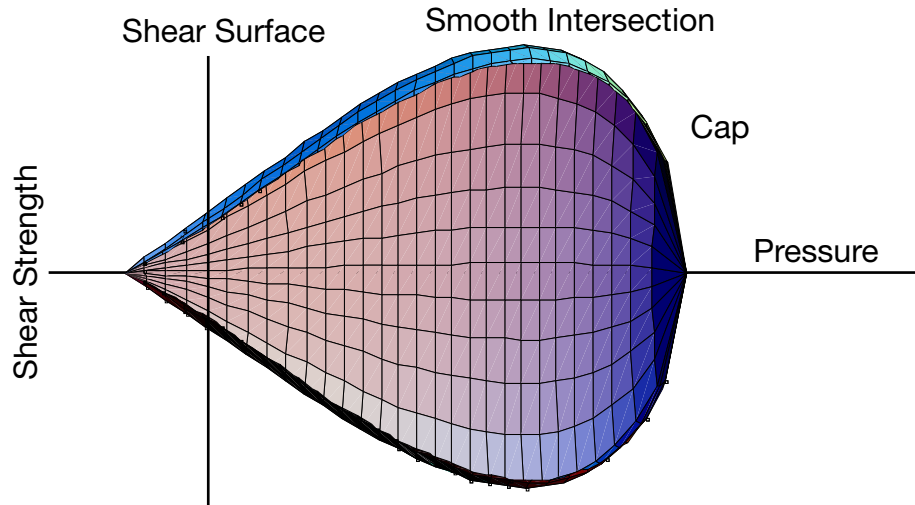

Figure 2-85. General shape of concrete model yield surface in two dimensions.

$$J'_2 = \frac{1}{2} S_{ij} S_{ij}$$

$$J'_3 = \frac{1}{3} S_{ij} S_{jk} S_{ki}$$

Plasticity Surface. The three invariant yield function is based on these three invariants, and the cap hardening parameter, κ , as follows:

$$f(J_1, J'_2, J'_3, \kappa) = J'_2 - \mathfrak{R}^2 F_f^2 F_c$$

Here F_f is the shear failure surface, F_c is the hardening cap, and \mathfrak{R} is the Rubin three-invariant reduction factor. The cap hardening parameter κ is the value of the pressure invariant at the intersection of the cap and shear surfaces.

Trial elastic stress invariants are temporarily updated via the trial elastic stress tensor, σ^T . These are denoted J_1^T, J_2^T , and J_3^T . Elastic stress states are modeled when $f(J_1^T, J_2^T, J_3^T, \kappa^T) \leq 0$. Elastic-plastic stress states are modeled when $f(J_1^T, J_2^T, J_3^T, \kappa^T) > 0$. In this case, the plasticity algorithm returns the stress state to the yield surface such that $f(J_1^P, J_2^P, J_3^P, \kappa^P) = 0$. This is accomplished by enforcing the plastic consistency condition with associated flow.

Shear Failure Surface. The strength of concrete is modeled by the shear surface in the tensile and low confining pressure regimes:

$$F_f(J_1) = \alpha - \lambda \exp^{-\beta J_1} + \theta J_1$$

Here the values of α, β, λ , and θ are selected by fitting the model surface to strength measurements from triaxial compression (TXC) tests conducted on plain concrete cylinders.

Rubin Scaling Function. Concrete fails at lower values of $\sqrt{3J'_2}$ (principal stress difference) for triaxial extension (TXE) and torsion (TOR) tests than it does for TXC tests conducted at the

same pressure. The Rubin scaling function \mathfrak{R} determines the strength of concrete for any state of stress relative to the strength for TXC, via $\mathfrak{R}F_f$. Strength in torsion is modeled as Q_1F_f . Strength in TXE is modeled as Q_2F_f , where:

$$Q_1 = \alpha_1 - \lambda_1 \exp^{-\beta_1 J_1} + \theta_1 J_1$$

$$Q_2 = \alpha_2 - \lambda_2 \exp^{-\beta_2 J_1} + \theta_2 J_1$$

Cap Hardening Surface. The strength of concrete is modeled by a combination of the cap and shear surfaces in the low to high confining pressure regimes. The cap is used to model plastic volume change related to pore collapse (although the pores are not explicitly modeled). The isotropic hardening cap is a two-part function that is either unity or an ellipse:

$$F_c(J_1, \kappa) = 1 - \frac{[J_1 - L(\kappa)][|J_1 - L(\kappa)| + J_1 - L(\kappa)]}{2 [X(\kappa) - L(\kappa)]^2}$$

where $L(\kappa)$ is defined as:

$$L(\kappa) = \begin{cases} \kappa & \text{if } \kappa > \kappa_0 \\ \kappa_0 & \text{otherwise} \end{cases}$$

The equation for F_c is equal to unity for $J_1 \leq L(\kappa)$. It describes the ellipse for $J_1 > L(\kappa)$. The intersection of the shear surface and the cap is at $J_1 = \kappa$. κ_0 is the value of J_1 at the *initial* intersection of the cap and shear surfaces before hardening is engaged (before the cap moves). The equation for $L(\kappa)$ restrains the cap from retracting past its initial location at κ_0 .

The intersection of the cap with the J_1 axis is at $J_1 = X(\kappa)$. This intersection depends upon the cap ellipticity ratio R , where R is the ratio of its major to minor axes:

$$X(\kappa) = L(\kappa) + RF_f[L(\kappa)]$$

The cap moves to simulate plastic volume change. The cap expands ($X(\kappa)$ and κ increase) to simulate plastic volume compaction. The cap contracts ($X(\kappa)$ and κ decrease) to simulate plastic volume expansion, called dilation. The motion (expansion and contraction) of the cap is based upon the hardening rule:

$$\varepsilon_v^p = W \left[1 - e^{-D_1(X-X_0) - D_2(X-X_0)^2} \right]$$

Here ε_v^p the plastic volume strain, W is the maximum plastic volume strain, and D_1 and D_2 are model input parameters. X_0 is the initial location of the cap when $\kappa = \kappa_0$.

The five input parameters (X_0 , W , D_1 , D_2 , and R) are obtained from fits to the pressure-volumetric strain curves in isotropic compression and uniaxial strain. X_0 determines the pressure at which compaction initiates in isotropic compression. R , combined with X_0 , determines the pressure at which compaction initiates in uniaxial strain. D_1 , and D_2 determine the shape of the pressure-volumetric strain curves. W determines the maximum plastic volume compaction.

Shear Hardening Surface. In unconfined compression, the stress-strain behavior of concrete exhibits nonlinearity and dilation prior to the peak. Such behavior is modeled with an initial shear yield surface, $N_H F_f$, which hardens until it coincides with the ultimate shear yield surface, F_f . Two input parameters are required. One parameter, N_H , initiates hardening by setting the location of the initial yield surface. A second parameter, C_H , determines the rate of hardening (amount of nonlinearity).

Damage. Concrete exhibits softening in the tensile and low to moderate compressive regimes.

$$\sigma_{ij}^d = (1 - d)\sigma_{ij}^{vp}$$

A scalar damage parameter, d , transforms the viscoplastic stress tensor without damage, denoted σ^{vp} , into the stress tensor with damage, denoted σ^d . Damage accumulation is based upon two distinct formulations, which we call brittle damage and ductile damage. The initial damage threshold is coincident with the shear plasticity surface, so the threshold does not have to be specified by the user.

Ductile Damage. Ductile damage accumulates when the pressure (P) is compressive and an energy-type term, τ_c , exceeds the damage threshold, τ_{0c} . Ductile damage accumulation depends upon the total strain components, ε_{ij} , as follows:

$$\tau_c = \sqrt{\frac{1}{2} \sigma_{ij} \varepsilon_{ij}}$$

The stress components σ_{ij} are the elasto-plastic stresses (with kinematic hardening) calculated before application of damage and rate effects.

Brittle Damage. Brittle damage accumulates when the pressure is tensile and an energy-type term, τ_t , exceeds the damage threshold, τ_{0t} . Brittle damage accumulation depends upon the maximum principal strain, ε_{\max} , as follows:

$$\tau_t = \sqrt{E \varepsilon_{\max}^2}$$

Softening Function. As damage accumulates, the damage parameter d increases from an initial value of zero, towards a maximum value of one, via the following formulations:

$$\begin{aligned} \text{Brittle Damage: } d(\tau_t) &= \frac{0.999}{D} \left[\frac{1 + D}{1 + D e^{-C(\tau_t - \tau_{0t})}} - 1 \right] \\ \text{Ductile Damage: } d(\tau_c) &= \frac{d_{\max}}{B} \left[\frac{1 + B}{1 + B e^{-A(\tau_c - \tau_{0c})}} - 1 \right] \end{aligned}$$

The damage parameter that is applied to the six stresses is equal to the current maximum of the brittle or ductile damage parameter. The parameters A and B or C and D set the shape of the softening curve plotted as stress-displacement or stress-strain. The parameter d_{\max} is the maximum damage level that can be attained. It is calculated internally.

is less than one at moderate confining pressures. The compressive softening parameter, A , may also be reduced with confinement, using the input parameter p_{mod} , as follows:

$$A = A(d_{max} + 0.001)^{p_{mod}}$$

Regulating Mesh Size Sensitivity. The concrete model maintains constant fracture energy, regardless of element size. The fracture energy is defined here as the area under the stress-displacement curve from peak strength to zero strength. This is done by internally formulating the softening parameters A and C in terms of the element length, l (cube root of the element volume), the fracture energy, G_f , the initial damage threshold, τ_{0t} or τ_{0c} , and the softening shape parameters, D or B .

The fracture energy is calculated from up to five user-specified input parameters: GFC, GFS, GFT, PWRC, and PWRT. The user specifies three distinct fracture energy values. These are the fracture energy in uniaxial tensile stress, GFT, pure shear stress, GFS, and uniaxial compressive stress, GFC. The model internally selects the fracture energy from equations which interpolate between the three fracture energy values as a function of the stress state (expressed via two stress invariants). The interpolation equations depend upon the user-specified input powers PWRC and PWRT, as follows.

$$\begin{aligned} \text{Tensile Pressure: } G_f &= GFS + \left(\frac{-J_1}{\sqrt{3J_2'}} \right)^{\overbrace{PWRT}^{k_t}} [GFT - GFS] \\ \text{Compressive Pressure: } G_f &= GFS + \left(\frac{J_1}{\sqrt{3J_2'}} \right)^{\overbrace{PWRC}^{k_c}} [GFC - GFS] \end{aligned}$$

The internal parameters k_c and k_t are restricted to the interval $[0,1]$.

Element Erosion. An element loses all strength and stiffness as $d \rightarrow 1$. To prevent computational difficulties with very low stiffness, element erosion is available as a user option. An element erodes when $d > 0.99$ and the maximum principal strain is greater than a user supplied input value, ERODE-1.0.

Viscoplastic Rate Effects. At each time step, the viscoplastic algorithm interpolates between the elastic trial stress, σ_{ij}^T , and the inviscid stress (without rate effects), σ_{ij}^P , to set the viscoplastic stress (with rate effects), σ_{ij}^{VP} :

$$\sigma_{ij}^{VP} = (1 - \gamma)\sigma_{ij}^T + \gamma\sigma_{ij}^P$$

where,

$$\gamma = \frac{\Delta t / \eta}{1 + \Delta t / \eta}$$

This interpolation depends upon the effective fluidity coefficient, η , and the time step, Δt . The effective fluidity coefficient is internally calculated from five user-supplied input parameters and interpolation equations:

$$\begin{aligned} \text{Tensile Pressure: } \eta &= \eta_s + \left(\frac{-J_1}{\sqrt{3J_2'}} \right)^{\text{PWRT}} [\eta_t - \eta_s] \\ \text{Compressive Pressure: } \eta &= \eta_s + \left(\frac{J_1}{\sqrt{3J_2'}} \right)^{\text{PWRC}} [\eta_c - \eta_s] \end{aligned}$$

where,

$$\eta_s = \text{SRATE} \times \eta_t$$

$$\eta_t = \frac{\text{ETA0T}}{\dot{\epsilon}^{\text{NT}}}$$

$$\eta_c = \frac{\text{ETA0C}}{\dot{\epsilon}^{\text{NC}}}$$

The input parameters are **ETA0T** and **NT** for fitting uniaxial tensile stress data, **ETA0X** and **NC** for fitting the uniaxial compressive stress data, and **SRATE** for fitting shear stress data. The effective strain rate is $\dot{\epsilon}$.

This viscoplastic model may predict substantial rate effects at high strain rates ($\dot{\epsilon} > 100$). To limit rate effects at high strain rates, the user may input overstress limits in tension **OVERT** and compression **OVERC**. These input parameters limit calculation of the fluidity parameter, as follows:

$$\text{if } E\dot{\epsilon}\eta > \text{OVER}, \text{ then } \eta = \frac{m}{E\dot{\epsilon}}$$

where $m = \text{OVERT}$ when the pressure is tensile, and $m = \text{OVERC}$ when the pressure is compressive.

The user has the option of increasing the fracture energy as a function of effective strain rate via the **REPOW** input parameter, as follows:

$$G_f^{\text{rate}} = G_f \left(1 + \frac{E\dot{\epsilon}\eta}{f'} \right)^{\text{REPOW}}$$

Here G_f^{rate} is the fracture energy enhanced by rate effects, and f' is the yield strength before application of rate effects (which is calculated internally by the model). The term in brackets is greater than, or equal to one, and is the approximate ratio of the dynamic to static strength.

***MAT_ALE_INCOMPRESSIBLE**

This is Material Type 160. This card allows to solve incompressible flows with the ALE solver. It should be used with the element formulation 6 and 12 in *SECTION_SOLID (elform = 6 or 12). A projection method enforces the incompressibility condition.

Card 1	1	2	3	4	5	6	7	8
Variable	MID	RO	PC	MU				
Type	I	F	F	F				
Default	none	none	0.0	0.0				

Card 2	1	2	3	4	5	6	7	8
Variable	TOL	DTOUT	NCG	METH				
Type	F	F	I	I				
Default	1e-8	1e10	50	-7				

VARIABLE**DESCRIPTION**

MID	Material ID. A unique number or label not exceeding 8 characters must be specified. Material ID is referenced in the *PART card and must be unique
RO	Material density
PC	Pressure cutoff (< or = 0.0)
MU	Dynamic viscosity coefficient
TOL	Tolerance for the convergence of the conjugate gradient
DTOUT	Time interval between screen outputs
NCG	Maximum number of loops in the conjugate gradient

VARIABLE	DESCRIPTION
METH	Conjugate gradient methods: EQ.-6: solves the poisson equation for the pressure EQ.-7: solves the poisson equation for the pressure increment

***MAT_COMPOSITE_MSC_{OPTION}**

Available options include:

<BLANK>

DMG

These are Material Types 161 and 162. These models may be used to model the progressive failure analysis for composite materials consisting of unidirectional and woven fabric layers. The progressive layer failure criteria have been established by adopting the methodology developed by Hashin [1980] with a generalization to include the effect of highly constrained pressure on composite failure. These failure models can be used to effectively simulate fiber failure, matrix damage, and delamination behavior under all conditions - opening, closure, and sliding of failure surfaces. The model with DMG option (material 162) is a generalization of the basic layer failure model of Material 161 by adopting the damage mechanics approach for characterizing the softening behavior after damage initiation. These models require an additional license from Materials Sciences Corporation, which developed and supports these models.

Card 1	1	2	3	4	5	6	7	8
Variable	MID	RO	EA	EB	EC	PRBA	PRCA	PRCB
Type	A8	F	F	F	F	F	F	F

Card 2	1	2	3	4	5	6	7	8
Variable	GAB	GBC	GCA	AOPT	MACF			
Type	F	F	F	F	I			

Card 3	1	2	3	4	5	6	7	8
Variable	XP	YP	ZP	A1	A2	A3		
Type	F	F	F	F	F	F		

Card 4	1	2	3	4	5	6	7	8
Variable	V1	V2	V3	D1	D2	D3	BETA	
Type	F	F	F	F	F	F	F	

Card 5	1	2	3	4	5	6	7	8
Variable	SAT	SAC	SBT	SBC	SCT	SFC	SFS	SAB
Type	F	F	F	F	F	F	F	F

Card 6	1	2	3	4	5	6	7	8
Variable	SBC	SCA	SFFC	AMODEL	PHIC	E_LIMT	S_DELM	
Type	F	F	F	F	F	F	F	

Card 7	1	2	3	4	5	6	7	8
Variable	OMGMX	ECRSH	EEXPN	CERATE1	AM1			
Type	F	F	F	F	F			

Failure Card. Additional card for DMG keyword option.

Card 8	1	2	3	4	5	6	7	8
Variable	AM2	AM3	AM4	CERATE2	CERATE3	CERATE4		
Type	F	F	F	F	F	F		

VARIABLE

DESCRIPTION

MID

Material identification. A unique number or label not exceeding 8 characters must be specified.

RO	Mass density
EA	E_a , Young's modulus - longitudinal direction
EB	E_b , Young's modulus - transverse direction
EC	E_c , Young's modulus - through thickness direction
PRBA	ν_{ba} , Poisson's ratio ba
PRCA	ν_{ca} , Poisson's ratio ca
PRCB	ν_{cb} , Poisson's ratio cb
GAB	G_{ab} , shear modulus ab
GBC	G_{bc} , shear modulus bc
GCA	G_{ca} , shear modulus ca
AOPT	Material axes option, see Figure 2-3 : EQ.0.0: locally orthotropic with material axes determined by element nodes as shown in Figure 2-3 . Nodes 1, 2, and 4 of an element are identical to the Nodes used for the definition of a coordinate system by *DEFINE_COORDINATE_NODES. EQ.1.0: locally orthotropic with material axes determined by a point in space and the global location of the element center, to define the a-direction. EQ.2.0: globally orthotropic with material axes determined by vectors defined below, as with *DEFINE_COORDINATE_VECTOR. EQ.3.0: locally orthotropic material axes determined by rotating the material axes about the element normal by an angle, BETA, from a line in the plane of the element defined by the cross product of the vector v with the element normal. The plane of a solid element is the midsurface between the inner surface and outer surface defined by the first four nodes and the last four nodes of the connectivity of the element, respectively. EQ.4.0: locally orthotropic in cylindrical coordinate system with the material axes determined by a vector v , and an originating point, p , which define the centerline axis. This op-

tion is for solid elements only.

LT.0.0: the absolute value of AOPT is a coordinate system ID number (CID on *DEFINE_COORDINATE_NODES, *DEFINE_COORDINATE_SYSTEM or *DEFINE_COORDINATE_VECTOR). Available in R3 version of 971 and later.

MACF	Material axes change flag: EQ.1: No change, default, EQ.2: switch material axes a and b, EQ.3: switch material axes a and c, EQ.4: switch material axes b and c.
XP, YP, ZP	Define coordinates of point p for AOPT = 1 and 4.
A1, A2, A3	Define components of vector a for AOPT = 2.
V1, V2, V3	Define components of vector v for AOPT = 3 and 4.
D1, D2, D3	Define components of vector d for AOPT = 2.
BETA	Layer in-plane rotational angle in degrees.
SAT	Longitudinal tensile strength
SAC	Longitudinal compressive strength
SBT	Transverse tensile strength
SBC	Transverse compressive strength
SCT	Through thickness tensile strength
SFC	Crush strength
SFS	Fiber mode shear strength
SAB	Matrix mode shear strength, ab plane, see below.
SBC	Matrix mode shear strength, bc plane, see below.
SCA	Matrix mode shear strength, ca plane, see below.
SFFC	Scale factor for residual compressive strength

AMODEL	Material models: EQ.1: Unidirectional layer model EQ.2: Fabric layer model
PHIC	Coulomb friction angle for matrix and delamination failure, < 90
E_LIMT	Element eroding axial strain
S_DELM	Scale factor for delamination criterion
OMGMX	Limit damage parameter for elastic modulus reduction
ECRSH	Limit compressive volume strain for element eroding
EEXPN	Limit tensile volume strain for element eroding
CERATE1	Coefficient for strain rate dependent strength properties
AM1	Coefficient for strain rate softening property for fiber damage in a direction.
AM2	Coefficient for strain rate softening property for fiber damage in b direction.
AM3	Coefficient for strain rate softening property for fiber crush and punch shear damage.
AM4	Coefficient for strain rate softening property for matrix and delamination damage.
CERATE2	Coefficient for strain rate dependent axial moduli.
CERATE3	Coefficient for strain rate dependent shear moduli.
CERATE4	Coefficient for strain rate dependent transverse moduli.

Material Models:

The unidirectional and fabric layer failure criteria and the associated property degradation models for material 161 are described as follows. All the failure criteria are expressed in terms of stress components based on ply level stresses ($\sigma_a, \sigma_b, \sigma_c, \tau_{ab}, \tau_{bc}, \tau_{ca}$) and the associated elastic moduli are ($E_a, E_b, E_c, G_{ab}, G_{bc}, G_{ca}$). Note that for the unidirectional model, a, b and c denote the fiber, in-plane transverse and out-of-plane directions, respectively, while for the fabric model, a, b and c denote the in-plane fill, in-plane warp and out-of-plane directions, respectively.

Unidirectional lamina model:

Three criteria are used for fiber failure, one in tension/shear, one in compression and another one in crush under pressure. They are chosen in terms of quadratic stress forms as follows:

Tensile/shear fiber mode:

$$f_1 = \left(\frac{\langle \sigma_a \rangle}{S_{aT}} \right)^2 + \left(\frac{\tau_{ab}^2 + \tau_{ca}^2}{S_{FS}^2} \right) - 1 = 0$$

Compression fiber mode:

$$f_2 = \left(\frac{\langle \sigma'_a \rangle}{S_{aC}} \right)^2 - 1 = 0, \quad \sigma'_a = -\sigma_a + \left\langle -\frac{\sigma_b + \sigma_c}{2} \right\rangle$$

Crush mode:

$$f_3 = \left(\frac{\langle p \rangle}{S_{FC}} \right)^2 - 1 = 0, \quad p = -\frac{\sigma_a + \sigma_b + \sigma_c}{3}$$

where $\langle \ \rangle$ are Macaulay brackets, S_{aT} and S_{aC} are the tensile and compressive strengths in the fiber direction, and S_{FS} and S_{FC} are the layer strengths associated with the fiber shear and crush failure, respectively.

Matrix mode failures must occur without fiber failure, and hence they will be on planes parallel to fibers. For simplicity, only two failure planes are considered: one is perpendicular to the planes of layering and the other one is parallel to them. The matrix failure criteria for the failure plane perpendicular and parallel to the layering planes, respectively, have the forms:

Perpendicular matrix mode:

$$f_4 = \left(\frac{\langle \sigma_b \rangle}{S_{bT}} \right)^2 + \left(\frac{\tau_{bc}}{S'_{bc}} \right)^2 + \left(\frac{\tau_{ab}}{S_{ab}} \right)^2 - 1 = 0$$

Parallel matrix mode (Delamination):

$$f_5 = S^2 \left\{ \left(\frac{\langle \sigma_c \rangle}{S_{bT}} \right)^2 + \left(\frac{\tau_{bc}}{S''_{bc}} \right)^2 + \left(\frac{\tau_{ca}}{S_{ca}} \right)^2 \right\} - 1 = 0$$

where S_{bT} is the transverse tensile strength. Based on the Coulomb-Mohr theory, the shear strengths for the transverse shear failure and the two axial shear failure modes are assumed to be the forms,

$$S_{ab} = S_{ab}^{(0)} + \tan(\varphi) \langle -\sigma_b \rangle$$

$$S'_{bc} = S_{bc}^{(0)} + \tan(\varphi) \langle -\sigma_b \rangle$$

$$S_{ca} = S_{ca}^{(0)} + \tan(\varphi) \langle -\sigma_c \rangle$$

$$S_{bc}'' = S_{bc}^{(0)} + \tan(\varphi)\langle -\sigma_c \rangle$$

where φ is a material constant as $\tan(\varphi)$ is similar to the coefficient of friction, and $S_{ab}^{(0)}$, $S_{ca}^{(0)}$ and $S_{bc}^{(0)}$ are the shear strength values of the corresponding tensile modes.

Failure predicted by the criterion of f_4 can be referred to as transverse matrix failure, while the matrix failure predicted by f_5 , which is parallel to the layer, can be referred as the delamination mode when it occurs within the elements that are adjacent to the ply interface. Note that a scale factor S is introduced to provide better correlation of delamination area with experiments. The scale factor S can be determined by fitting the analytical prediction to experimental data for the delamination area.

When fiber failure in tension/shear mode is predicted in a layer by f_1 , the load carrying capacity of that layer is completely eliminated. All the stress components are reduced to zero instantaneously (100 time steps to avoid numerical instability). For compressive fiber failure, the layer is assumed to carry a residual axial load, while the transverse load carrying capacity is reduced to zero. When the fiber compressive failure mode is reached due to f_2 , the axial layer compressive strength stress is assumed to reduce to a residual value S_{RC} ($=SFFC \times S_{AC}$). The axial stress is then assumed to remain constant, i.e., $\sigma_a = -S_{RC}$, for continuous compressive loading, while the subsequent unloading curve follows a reduced axial modulus to zero axial stress and strain state. When the fiber crush failure occurs, the material is assumed to behave elastically for compressive pressure, $p > 0$, and to carry no load for tensile pressure, $p < 0$.

When a matrix failure (delamination) in the a-b plane is predicted, the strength values for $S_{ca}^{(0)}$ and $S_{bc}^{(0)}$ are set to zero. This results in reducing the stress components σ_c , τ_{bc} and τ_{ca} to the fractured material strength surface. For tensile mode, $\sigma_c > 0$, these stress components are reduced to zero. For compressive mode, $\sigma_c < 0$, the normal stress σ_c is assumed to deform elastically for the closed matrix crack. Loading on the failure envelop, the shear stresses are assumed to 'slide' on the fractured strength surface (frictional shear stresses) like in an ideal plastic material, while the subsequent unloading shear stress-strain path follows reduced shear moduli to the zero shear stress and strain state for both τ_{bc} and τ_{ca} components.

The post failure behavior for the matrix crack in the a-c plane due to f_4 is modeled in the same fashion as that in the a-b plane as described above. In this case, when failure occurs, $S_{ab}^{(0)}$ and $S_{bc}^{(0)}$ are reduced to zero instantaneously. The post fracture response is then governed by failure criterion of f_5 with $S_{ab}^{(0)} = 0$ and $S_{bc}^{(0)} = 0$. For tensile mode, $\sigma_b > 0$, σ_b , τ_{ab} and τ_{bc} are zero. For compressive mode, $\sigma_b < 0$, σ_b is assumed to be elastic, while τ_{ab} and τ_{bc} 'slide' on the fracture strength surface as in an ideal plastic material, and the unloading path follows reduced shear moduli to the zero shear stress and strain state. It should be noted that τ_{bc} is governed by both the failure functions and should lie within or on each of these two strength surfaces.

Fabric lamina model:

The fiber failure criteria of Hashin for a unidirectional layer are generalized to characterize the fiber damage in terms of strain components for a plain weave layer. The fill and warp fiber tensile/shear failure are given by the quadratic interaction between the associated axial and shear stresses, i.e.

$$f_6 = \left(\frac{\langle \sigma_a \rangle}{S_{aT}} \right)^2 + \frac{(\tau_{ab}^2 + \tau_{ca}^2)}{S_{aFS}^2} - 1 = 0$$

$$f_7 = \left(\frac{\langle \sigma_b \rangle}{S_{bT}} \right)^2 + \frac{(\tau_{ab}^2 + \tau_{bc}^2)}{S_{bFS}^2} - 1 = 0$$

where S_{aT} and S_{bT} are the axial tensile strengths in the fill and warp directions, respectively, and S_{aFS} and S_{bFS} are the layer shear strengths due to fiber shear failure in the fill and warp directions. These failure criteria are applicable when the associated σ_a or σ_b is positive. It is assumed $S_{aFS} = SFS$, and

$$S_{bFS} = SFS \times \frac{S_{bT}}{S_{aT}}$$

When σ_a or σ_b is compressive, it is assumed that the in-plane compressive failure in both the fill and warp directions are given by the maximum stress criterion, i.e.

$$f_8 = \left[\frac{\langle \sigma'_a \rangle}{S_{aC}} \right]^2 - 1 = 0, \quad \sigma'_a = -\sigma_a + \langle -\sigma_c \rangle$$

$$f_9 = \left[\frac{\langle \sigma'_b \rangle}{S_{bC}} \right]^2 - 1 = 0, \quad \sigma'_b = -\sigma_b + \langle -\sigma_c \rangle$$

where S_{aC} and S_{bC} are the axial compressive strengths in the fill and warp directions, respectively. The crush failure under compressive pressure is

$$f_{10} = \left(\frac{\langle p \rangle}{S_{FC}} \right)^2 - 1 = 0, \quad p = -\frac{\sigma_a + \sigma_b + \sigma_c}{3}$$

A plain weave layer can fail under in-plane shear stress without the occurrence of fiber breakage. This in-plane matrix failure mode is given by

$$f_{11} = \left(\frac{\tau_{ab}}{S_{ab}} \right)^2 - 1 = 0$$

where S_{ab} is the layer shear strength due to matrix shear failure.

Another failure mode, which is due to the quadratic interaction between the thickness stresses, is expected to be mainly a matrix failure. This through the thickness matrix failure criterion is

$$f_{12} = S^2 \left\{ \left(\frac{\langle \sigma_c \rangle}{S_{cT}} \right)^2 + \left(\frac{\tau_{bc}}{S_{bc}} \right)^2 + \left(\frac{\tau_{ca}}{S_{ca}} \right)^2 \right\} - 1 = 0$$

where S_{cT} is the through the thickness tensile strength, and S_{bc} , and S_{ca} are the shear strengths assumed to depend on the compressive normal stress σ_c , i.e.,

$$\begin{Bmatrix} S_{ca} \\ S_{bc} \end{Bmatrix} = \begin{Bmatrix} S_{ca}^{(0)} \\ S_{bc}^{(0)} \end{Bmatrix} + \tan(\varphi) \langle -\sigma_c \rangle$$

When failure predicted by this criterion occurs within elements that are adjacent to the ply interface, the failure plane is expected to be parallel to the layering planes, and, thus, can be referred to as the delamination mode. Note that a scale factor S is introduced to provide better correlation of delamination area with experiments. The scale factor S can be determined by fitting the analytical prediction to experimental data for the delamination area.

Similar to the unidirectional model, when fiber tensile/shear failure is predicted in a layer by f6 or f7, the load carrying capacity of that layer in the associated direction is completely eliminated. For compressive fiber failure due to by f8 or f9, the layer is assumed to carry a residual axial load in the failed direction, while the load carrying capacity transverse to the failed direction is assumed unchanged. When the compressive axial stress in a layer reaches the compressive axial strength S_{aC} or S_{bC} , the axial layer stress is assumed to be reduced to the residual strength S_{aRC} or S_{bRC} where $S_{aRC} = \text{SFFC} \times S_{aC}$ and $S_{bRC} = \text{SFFC} \times S_{bC}$. The axial stress is assumed to remain constant, i.e., $\sigma_a = -S_{aCR}$ or $\sigma_b = -S_{bCR}$, for continuous compressive loading, while the subsequent unloading curve follows a reduced axial modulus. When the fiber crush failure is occurred, the material is assumed to behave elastically for compressive pressure, $p > 0$, and to carry no load for tensile pressure, $p < 0$.

When the in-plane matrix shear failure is predicted by f11 the axial load carrying capacity within a failed element is assumed unchanged, while the in-plane shear stress is assumed to be reduced to zero.

For through the thickness matrix (delamination) failure given by equations f12, the in-plane load carrying capacity within the element is assumed to be elastic, while the strength values for the tensile mode, $S_{ca}^{(0)}$ and $S_{bc}^{(0)}$, are set to zero. For tensile mode, $\sigma_c > 0$, the through the thickness stress components are reduced to zero. For compressive mode, $\sigma_c < 0$, σ_c is assumed to be elastic, while τ_{bc} and τ_{ca} 'slide' on the fracture strength surface as in an ideal plastic material, and the unloading path follows reduced shear moduli to the zero shear stress and strain state.

The effect of strain-rate on the layer strength values of the fiber failure modes is modeled by the strain-rate dependent functions for the strength values $\{S_{RT}\}$ as

$$\{S_{RT}\} = \{S_0\} \left(1 + C_{\text{rate1}} \ln \frac{\{\dot{\epsilon}\}}{\dot{\epsilon}_0} \right)$$

$$\{S_{RT}\} = \begin{Bmatrix} S_{aT} \\ S_{aC} \\ S_{bT} \\ S_{bC} \\ S_{FC} \\ S_{FS} \end{Bmatrix}, \quad \{\dot{\epsilon}\} = \begin{Bmatrix} |\dot{\epsilon}_a| \\ |\dot{\epsilon}_a| \\ |\dot{\epsilon}_b| \\ |\dot{\epsilon}_b| \\ |\dot{\epsilon}_c| \\ (\dot{\epsilon}_{ca}^2 + \dot{\epsilon}_{bc}^2)^{1/2} \end{Bmatrix}$$

where C_{rate} is the strain-rate constants, and $\{S_0\}$ are the strength values of $\{S_{RT}\}$ at the reference strain-rate $\dot{\epsilon}_0$.

Damage model:

The damage model is a generalization of the layer failure model of Material 161 by adopting the MLT damage mechanics approach, Matzenmiller et al. [1995], for characterizing the softening behavior after damage initiation. Complete model description is given in Yen [2002]. The damage functions, which are expressed in terms of ply level engineering strains, are converted from the above failure criteria of fiber and matrix failure modes by neglecting the Poisson’s effect. Elastic moduli reduction is expressed in terms of the associated damage parameters ω_i :

$$E'_i = (1 - \omega_i)E_i$$

$$\omega_i = 1 - \exp\left(-\frac{r_i^{m_i}}{m_i}\right), \quad r_i \geq 0, \quad i = 1, \dots, 6,$$

where E_i are the initial elastic moduli, E'_i are the reduced elastic moduli, r_i are the damage thresholds computed from the associated damage functions for fiber damage, matrix damage and delamination, and m_i are material damage parameters, which are currently assumed to be independent of strain-rate. The damage function is formulated to account for the overall nonlinear elastic response of a lamina including the initial ‘hardening’ and the subsequent softening beyond the ultimate strengths.

In the damage model (material 162), the effect of strain-rate on the nonlinear stress-strain response of a composite layer is modeled by the strain-rate dependent functions for the elastic moduli $\{E_{RT}\}$ as

$$\{E_{RT}\} = \{E_0\} \left(1 + \{C_{rate}\} \ln \frac{\{\dot{\epsilon}\}}{\dot{\epsilon}_0}\right)$$

$$\{E_{RT}\} = \begin{Bmatrix} E_a \\ E_b \\ E_c \\ G_{ab} \\ G_{bc} \\ G_{ca} \end{Bmatrix}, \quad \{\dot{\epsilon}\} = \begin{Bmatrix} |\dot{\epsilon}_a| \\ |\dot{\epsilon}_b| \\ |\dot{\epsilon}_c| \\ |\dot{\epsilon}_{ab}| \\ |\dot{\epsilon}_{bc}| \\ |\dot{\epsilon}_{ca}| \end{Bmatrix}, \quad \{C_{rate}\} = \begin{Bmatrix} C_{rate2} \\ C_{rate2} \\ C_{rate4} \\ C_{rate3} \\ C_{rate3} \\ C_{rate3} \end{Bmatrix}$$

where $\{C_{rate}\}$ are the strain-rate constants. $\{E_0\}$ are the modulus values of $\{E_{RT}\}$ at the reference strain-rate $\dot{\epsilon}_0$.

Element Erosion:

A failed element is eroded in any of three different ways:

1. If fiber tensile failure in a unidirectional layer is predicted in the element and the axial tensile strain is greater than E_LIMT. For a fabric layer, both in-plane directions are failed and exceed E_LIMT.
2. If compressive relative volume in a failed element is smaller than ECRSH.
3. If tensile relative volume in a failed element is greater than EEXPV.

Damage History Parameters:

Information about the damage history variables for the associated failure modes can be plotted in LS-PrePost. These additional history variables are tabulated below:

History Variable	Description	Value	LS-PrePost History Variable
1. efa(I)	Fiber mode in a		7
2. efb(I)	Fiber mode in b	0-elastic	8
3. efp(I)	Fiber crush mode		9
4. em(I)	Perpendicular matrix mode	≥ 1 -failed	10
5. ed(I)	Parallel matrix/ delamination mode		11
6. delm(I)	delamination mode		12

***MAT_MODIFIED_CRUSHABLE_FOAM**

This is Material Type 163 which is dedicated to modeling crushable foam with optional damping, tension cutoff, and strain rate effects. Unloading is fully elastic. Tension is treated as elastic-perfectly-plastic at the tension cut-off value.

Card 1	1	2	3	4	5	6	7	8
Variable	MID	RO	E	PR	TID	TSC	DAMP	NCYCLE
Type	A8	F	F	F	F	F	F	F
Default	none	none	none	none	none	0.0	0.10	12.

Card 2	1	2	3	4	5	6	7	8
Variable	SRCLMT	SFLAG						
Type	F	I						
Default	1.E+20	0						

VARIABLE**DESCRIPTION**

MID	Material identification. A unique number or label not exceeding 8 characters must be specified.
RO	Mass density
E	Young's modulus
PR	Poisson's ratio
TID	Table ID defining yield stress versus volumetric strain, γ , at different strain rates.
TSC	Tensile stress cutoff. A nonzero, positive value is strongly recommended for realistic behavior.
DAMP	Rate sensitivity via damping coefficient ($.05 <$ recommended value $<.50$).

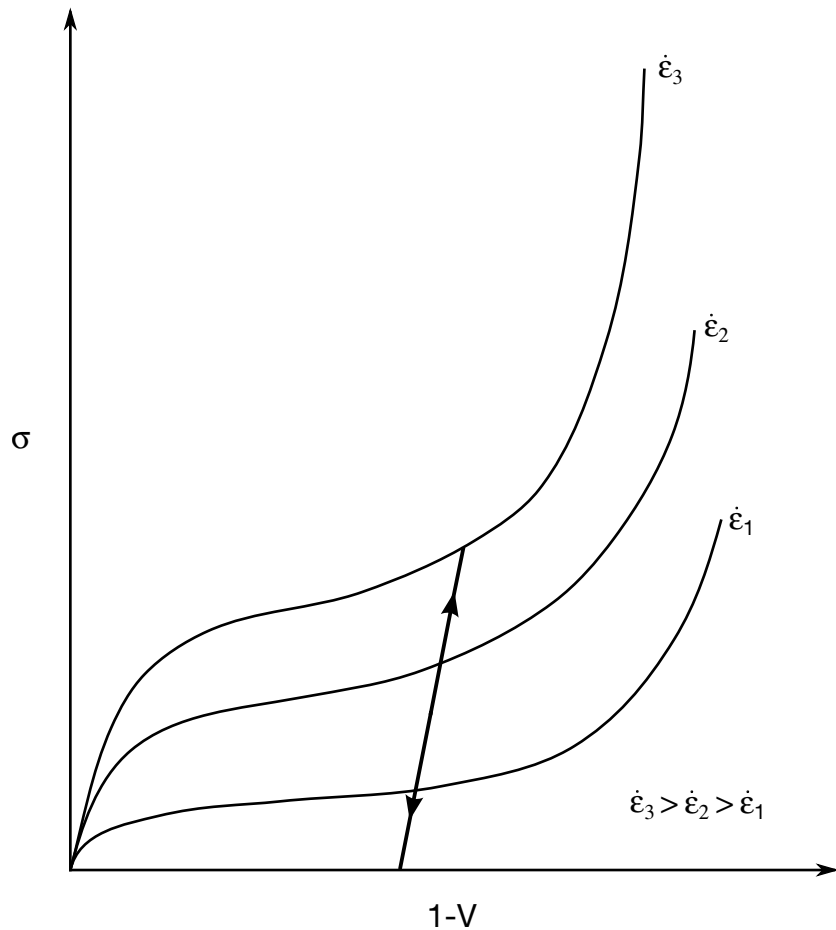

Figure 2-86. Rate effects are defined by a family of curves giving yield stress versus volumetric strain where V is the relative volume.

VARIABLE	DESCRIPTION
NCYCLE	Number of cycles to determine the average volumetric strain rate.
SRCLMT	Strain rate change limit.
SFLAG	The strain rate in the table may be the true strain rate (SFLAG = 0) or the engineering strain rate (SFLAG = 1).

Remarks:

The volumetric strain is defined in terms of the relative volume, V , as:

$$\gamma = 1 - V$$

The relative volume is defined as the ratio of the current to the initial volume. In place of the effective plastic strain in the D3PLOT database, the integrated volumetric strain is output.

This material is an extension of material 63, *MAT_CRUSHABLE_FOAM. It allows the yield stress to be a function of both volumetric strain rate and volumetric strain. Rate effects are accounted for by defining a table of curves using *DEFINE_TABLE. Each curve defines the yield stress versus volumetric strain for a different strain rate. The yield stress is obtained by interpolating between the two curves that bound the strain rate.

To prevent high frequency oscillations in the strain rate from causing similar high frequency oscillations in the yield stress, a modified volumetric strain rate is used when interpolating to obtain the yield stress. The modified strain rate is obtained as follows. If NYCYLE is > 1 , then the modified strain rate is obtained by a time average of the actual strain rate over NYCYLE solution cycles. For SRCLMT > 0 , the modified strain rate is capped so that during each cycle, the modified strain rate is not permitted to change more than SRCLMT multiplied by the solution time step.

***MAT_BRAIN_LINEAR_VISCOELASTIC**

This is Material Type 164. This material is a Kelvin-Maxwell model for modeling brain tissue, which is valid for solid elements only. See Remarks below.

Card 1	1	2	3	4	5	6	7	8
Variable	MID	RO	BULK	G0	GI	DC	FO	S0
Type	A8	F	F	F	F	F	F	F
Default	none	none	none	none	none	0.0	0.0	0.0

VARIABLE**DESCRIPTION**

MID	Material identification. A unique number or label not exceeding 8 characters must be specified.
RO	Mass density
BULK	Bulk modulus (elastic)
G0	Short-time shear modulus, G_0
GI	Long-time (infinite) shear modulus, G_∞
DC	Maxwell decay constant, β [FO = 0.0] or Kelvin relaxation constant, τ [FO = 1.0]
FO	Formulation option: EQ.0.0: Maxwell, EQ.1.0: Kelvin.

VARIABLE	DESCRIPTION
SO	<p>Strain (logarithmic) output option to control what is written as component 7 to the d3plot database. (LS-PrePost always blindly labels this component as effective plastic strain.) The maximum values are updated for each element each time step:</p> <p>EQ.0.0: maximum principal strain that occurs during the calculation,</p> <p>EQ.1.0: maximum magnitude of the principal strain values that occurs during the calculation,</p> <p>EQ.2.0: maximum effective strain that occurs during the calculation.</p>

Remarks:

The shear relaxation behavior is described for the Maxwell model by:

$$G(t) = G + (G_0 - G_\infty)e^{-\beta t}$$

A Jaumann rate formulation is used

$$\overset{\nabla}{\sigma}_{ij} = 2 \int_0^t G(t - \tau) D'_{ij}(\tau) dt$$

where the prime denotes the deviatoric part of the stress rate, $\overset{\nabla}{\sigma}_{ij}$, and the strain rate D_{ij} . For the Kelvin model the stress evolution equation is defined as:

$$\dot{s}_{ij} + \frac{1}{\tau} s_{ij} = (1 + \delta_{ij}) G_0 \dot{e}_{ij} + (1 + \delta_{ij}) \frac{G_\infty}{\tau} \dot{e}_{ij}$$

The strain data as written to the d3plot database may be used to predict damage, see [Bandak 1991].

***MAT_PLASTIC_NONLINEAR_KINEMATIC**

This is Material Type 165. This relatively simple model, based on a material model by Lemaitre and Chaboche [1990], is suited to model nonlinear kinematic hardening plasticity. The model accounts for the nonlinear Bauschinger effect, cyclic hardening, and ratcheting. Huang [2006] programmed this model and provided it as a user subroutine. It is a very cost effective model and is available shell and solid elements.

Card 1	1	2	3	4	5	6	7	8
Variable	MID	RO	E	PR	SIGY	H	C	GAMMA
Type	A8	F	F	F	F	F	F	F
Default	none	none	none	none	none	0.0	0.0	0.0

Card 2	1	2	3	4	5	6	7	8
Variable	FS							
Type	F							
Default	1.E+16							

VARIABLE**DESCRIPTION**

MID	Material identification. A unique number or label not exceeding 8 characters must be specified.
RO	Mass density.
E	Young's modulus.
PR	Poisson's ratio.
SIGY	Initial yield stress, σ_{y0} .
H	Isotropic plastic hardening modulus
C	Kinematic hardening modulus

VARIABLE	DESCRIPTION
GAMMA	Kinematic hardening parameter, γ .
FS	Failure strain for eroding elements.

Remarks:

If the isotropic hardening modulus, H , is nonzero, the size of the surface increases as function of the equivalent plastic strain, ϵ^p :

$$\sigma_y = \sigma_{y0} + H\epsilon^p$$

The rate of evolution of the kinematic component is a function of the plastic strain rate:

$$\dot{\alpha} = [Cn - \gamma\alpha]\dot{\epsilon}^p$$

where, n , is the flow direction. The term, $\gamma\alpha\dot{\epsilon}^p$, introduces the nonlinearity into the evolution law, which becomes linear if the parameter, γ , is set to zero.

***MAT_MOMENT_CURVATURE_BEAM**

This is Material Type 166. This material is for performing nonlinear elastic or multi-linear plastic analysis of Belytschko-Schwer beams with user-defined axial force-strain, moment curvature and torque-twist rate curves. If strain, curvature or twist rate is located outside the curves, use extrapolation to determine the corresponding rigidity. For multi-linear plastic analysis, the user-defined curves are used as yield surfaces.

Card 1	1	2	3	4	5	6	7	8
Variable	MID	R0	E	ELAF	EPFLG	CTA	CTB	CTT
Type	A8	F	F	F	F	F	F	F
Default	none	none	none	none	0.0	0.0	0.0	0.0

Card 2	1	2	3	4	5	6	7	8
Variable	N1	N2	N3	N4	N5	N6	N7	N8
Type	F	F	F	F	F	F	F	F
Default	none	none	0.0 / none	0.0	0.0	0.0	0.0	0.0

Card 3	1	2	3	4	5	6	7	8
Variable	LCMS1	LCMS2	LCMS3	LCMS4	LCMS5	LCMS6	LCMS7	LCMS8
Type	F	F	F	F	F	F	F	F
Default	none	none	0.0 / none	0.0	0.0	0.0	0.0	0.0

Card 4	1	2	3	4	5	6	7	8
Variable	LCMT1	LCMT2	LCMT3	LCMT4	LCMT5	LCMT6	LCMT7	LCMT8
Type	F	F	F	F	F	F	F	F
Default	none	none	0.0 / none	0.0	0.0	0.0	0.0	0.0

Card 5	1	2	3	4	5	6	7	8
Variable	LCT1	LCT2	LCT3	LCT4	LCT5	LCT6	LCT7	LCT8
Type	F	F	F	F	F	F	F	F
Default	none	none	0.0 / none	0.0	0.0	0.0	0.0	0.0

Multilinear Plastic Analysis Card. Additional card for EPFLG = 1.

Card 6	1	2	3	4	5	6	7	8
Variable	CFA	CFB	CFT	HRULE	REPS	RBETA	RCAPAY	RCAPAZ
Type	F	F	F	F	F	F	F	F
Default	1.0	1.0	1.0	0.0	1.0E+20	1.0E+20	1.0E+20	1.0E+20

VARIABLE

DESCRIPTION

- MID Material identification. A unique number or label not exceeding 8 characters must be specified.
- RO Mass density
- E Young's modulus. This variable controls the time step size and must be chosen carefully. Increasing the value of E will decrease the time step size.

VARIABLE	DESCRIPTION
ELAF	Load curve ID for the axial force-strain curve
EPFLG	Function flag EQ.0.0: nonlinear elastic analysis EQ.1.0: multi-linear plastic analysis
CTA, CTB, CTT	Type of axial force-strain, moment-curvature, and torque-twist rate curves EQ.0.0: curve is symmetric EQ.1.0: curve is asymmetric For symmetric curves, all data point must be in the first quadrant and at least three data points need to be given, starting from the origin, ensued by the yield point. For asymmetric curves, at least five data points are needed and exactly one point must be at the origin. The two points on both sides of the origin record the positive and negative yield points. The last data point(s) has no physical meaning: it serves only as a control point for inter or extrapolation. The curves are input by the user and treated in LS-DYNA as a linearly piecewise function. The curves must be monotonically increasing, while the slopes must be monotonically decreasing
N1 - N8	Axial forces at which moment-curvature curves are given. The axial forces must be ordered monotonically increasing. At least two axial forces must be defined if the curves are symmetric. At least three axial forces must be defined if the curves are asymmetric.
LCMS1 - LCMS8	Load curve IDs for the moment-curvature curves about axis S under corresponding axial forces.
LCMT1 - LCMT8	Load curve IDs for the moment-curvature curves about axis T under corresponding axial forces.
LCT1 - LCT8	Load curve IDs for the torque-twist rate curves under corresponding axial forces.
CFA, CFB, CFT	For multi-linear plastic analysis only. Ratio of axial, bending and torsional elastic rigidities to their initial values, no less than 1.0 in value.

VARIABLE	DESCRIPTION
HRULE	Hardening rule, for multi-linear plastic analysis only. EQ.0.0: isotropic hardening GT.0.0.AND.LT.1.0: mixed hardening EQ.1.0: kinematic hardening
REPS	Rupture effective plastic axial strain
RBETA	Rupture effective plastic twist rate
RCAPAY	Rupture effective plastic curvature about axis S
RCAPAZ	Rupture effective plastic curvature about axis T

***MAT_MCCORMICK**

This is Material Type 167. This is a constitutive model for finite plastic deformities in which the material's strength is defined by McCormick's constitutive relation for materials exhibiting negative steady-state Strain Rate Sensitivity (SRS). McCormick [1988] and Zhang, McCormick and Estrin [2001].

Card 1	1	2	3	4	5	6	7	8
Variable	MID	RO	E	PR	SIGY			
Type	A8	F	F	F	F			

Card 2	1	2	3	4	5	6	7	8
Variable	Q1	C1	Q2	C2				
Type	F	F	F	F				

Card 3	1	2	3	4	5	6	7	8
Variable	S	H	OMEGA	TD	ALPHA	EPS0		
Type	F	F	F	F	F	F		

VARIABLE**DESCRIPTION**

MID	Material identification. A unique number or label not exceeding 8 characters must be specified.
RO	Mass density.
E	Young's modulus.
PR	Poisson's ratio.
SIGY	Initial yield stress
Q1	Isotropic hardening parameter, Q_1
C1	Isotropic hardening parameter, C_1

VARIABLE	DESCRIPTION
Q2	Isotropic hardening parameter, Q_2
C2	Isotropic hardening parameter, C_2
S	Dynamic strain aging parameter, S
H	Dynamic strain aging parameter, H
OMEGA	Dynamic strain aging parameter, Ω
TD	Dynamic strain aging parameter, t_d
ALPHA	Dynamic strain aging parameter, α
EPS0	Reference strain rate, $\dot{\epsilon}_0$

Remarks:

The uniaxial stress-strain curve is given in the following form:

$$\sigma(\epsilon^p, \dot{\epsilon}^p) = \sigma_Y(t_a) + R(\epsilon^p) + \sigma_v(\dot{\epsilon}^p)$$

Viscous stress σ_v is given by

$$\sigma_v(\dot{\epsilon}^p) = S \times \ln \left(1 + \frac{\dot{\epsilon}^p}{\dot{\epsilon}_0} \right)$$

where S represents the instantaneous strain rate sensitivity and $\dot{\epsilon}_0$ is a reference strain rate.

In the McCormick model the yield strength including the contribution from dynamic strain aging (DSA) is defined as

$$\sigma_Y(t_a) = \sigma_o + S \times H \times \left[1 - \exp \left\{ - \left(\frac{t_a}{t_d} \right)^\alpha \right\} \right]$$

where σ_o is the yield strength for vanishing average waiting time t_a , and H , α , and t_d are material constants linked to dynamic strain aging.

The average waiting time is defined by the evolution equation

$$\dot{t}_a = 1 - \frac{t_a}{t_{a,ss}}$$

where the quasi-steady state waiting time $t_{a,ss}$ is given as

$$t_{a,ss} = \frac{\Omega}{\dot{\epsilon}^p}$$

The strain hardening function R is defined by the extended Voce Law

$$R(\varepsilon^p) = Q_1[1 - \exp(-C_1\varepsilon^p)] + Q_2[1 - \exp(-C_2\varepsilon^p)].$$

*MAT_POLYMER

This is material type 168. This model is implemented for brick elements.

Card 1	1	2	3	4	5	6	7	8
Variable	MID	RO	E	PR	GAMMA0	DG	SC	ST
Type	A8	F	F	F	F	F	F	F

Card 2	1	2	3	4	5	6	7	8
Variable	TEMP	K	CR	N	C			
Type	F	F	F	F	F			

VARIABLE**DESCRIPTION**

MID	Material identification. A unique number or label not exceeding 8 characters must be specified.
RO	Mass Density.
E	Young's modulus, E .
PR	Poisson's ratio, ν .
GAMMA0	Pre-exponential factor, $\dot{\gamma}_{0A}$.
DG	Energy barrier to flow, ΔG .
SC	Shear resistance in compression, S_c .
ST	Shear resistance in tension, S_t .
TEMP	Absolute temperature, θ .
K	Boltzmann constant, k .
CR	Product, $C_r = nk\theta$.
N	Number of 'rigid links' between entanglements, N .
C	Relaxation factor, C .

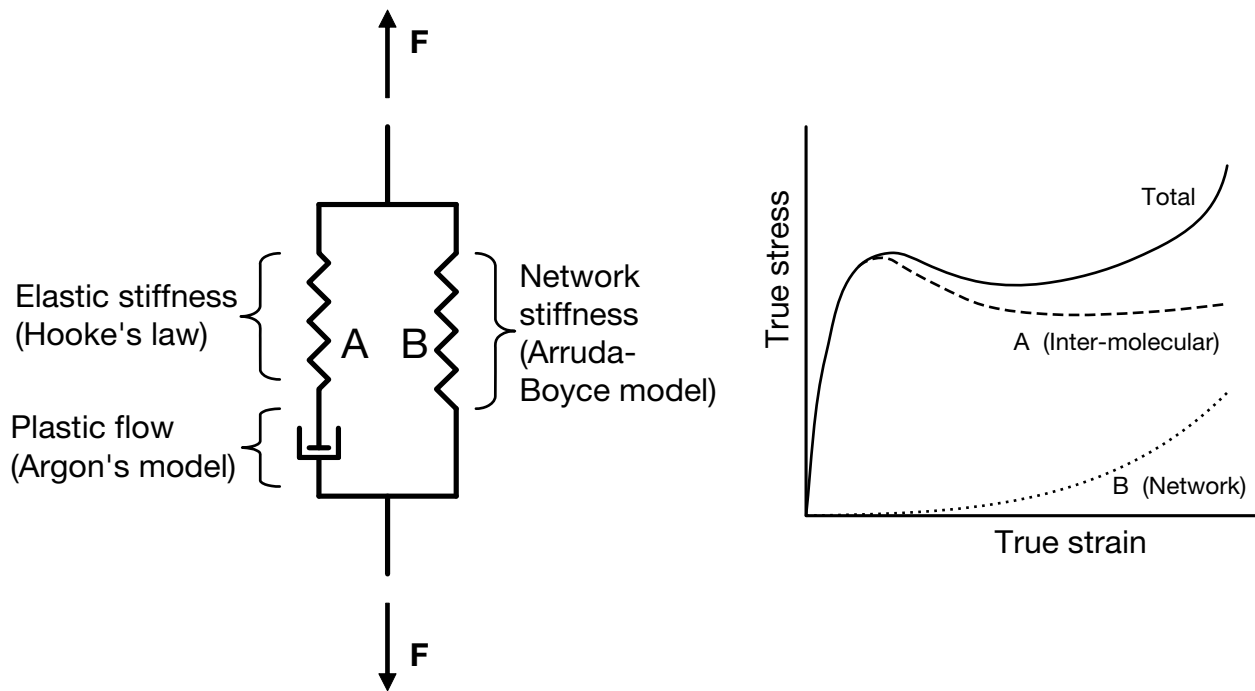

Figure 2-87. Stress decomposition in inter-molecular and network contributions.

Remarks:

The polymer is assumed to have two basic resistances to deformation:

1. An inter-molecular barrier to deformation related to relative movement between molecules.
2. An evolving anisotropic resistance related to straightening of the molecule chains.

The model which is implemented and presented in this paper is mainly based on the framework suggested by Boyce et al. [2000]. Going back to the original work by Haward and Thackray [1968], they considered the uniaxial case only. The extension to a full 3D formulation was proposed by Boyce et al. [1988]. Moreover, Boyce and co-workers have during a period of 20 years changed or further developed the parts of the original model. Haward and Thackray [1968] used an Eyring model to represent the dashpot in Fig. 2-87, while Boyce et al. [2000] employed the double-kink model of Argon [1973] instead. Part B of the model, describing the resistance associated with straightening of the molecules, contained originally a one-dimensional Langevin spring [Haward and Thackray, 1968], which was generalized to 3D with the eight-chain model by Arruda and Boyce [1993].

The main structure of the model presented by Boyce et al. [2000] is kept for this model. Recognizing the large elastic deformations occurring for polymers, a formulation based on

a Neo-Hookean material is here selected for describing the spring in resistance A in [Figure 2-87](#).

Referring to [Figure 2-87](#), it is assumed that the deformation gradient tensor is the same for the two resistances (Part A and B)

$$\mathbf{F} = \mathbf{F}_A = \mathbf{F}_B$$

while the Cauchy stress tensor for the system is assumed to be the sum of the Cauchy stress tensors for the two parts

$$\boldsymbol{\sigma} = \boldsymbol{\sigma}_A + \boldsymbol{\sigma}_B.$$

Part A: Inter-molecular resistance:

The deformation is decomposed into elastic and plastic parts, $\mathbf{F}_A = \mathbf{F}_A^e \cdot \mathbf{F}_A^p$, where it is assumed that the intermediate configuration $\bar{\Omega}_A$ defined by \mathbf{F}_A^p is invariant to rigid body rotations of the current configuration. The velocity gradient in the current configuration Ω is defined by

$$\mathbf{L}_A = \dot{\mathbf{F}}_A \cdot \mathbf{F}_A^{-1} = \mathbf{L}_A^e + \mathbf{L}_A^p$$

Owing to the decomposition, $\mathbf{F}_A = \mathbf{F}_A^e \cdot \mathbf{F}_A^p$, the elastic and plastic rate-of-deformation and spin tensors are defined by

$$\begin{aligned} \mathbf{L}_A^e &= \mathbf{D}_A^e + \mathbf{W}_A^e = \dot{\mathbf{F}}_A^e \cdot (\mathbf{F}_A^e)^{-1} \\ \mathbf{L}_A^p &= \mathbf{D}_A^p + \mathbf{W}_A^p = \mathbf{F}_A^e \cdot \dot{\mathbf{F}}_A^p \cdot (\mathbf{F}_A^p)^{-1} \cdot (\mathbf{F}_A^e)^{-1} = \mathbf{F}_A^e \cdot \bar{\mathbf{L}}_A^p \cdot (\mathbf{F}_A^e)^{-1} \end{aligned}$$

where $\bar{\mathbf{L}}_A^p = \dot{\mathbf{F}}_A^p \cdot (\mathbf{F}_A^p)^{-1}$. The Neo-Hookean material represents an extension of Hooke's law to large elastic deformations and may be chosen for the elastic part of the deformation when the elastic behavior is assumed to be isotropic.

$$\boldsymbol{\tau}_A = \lambda_0 \ln J_A^e \mathbf{I} + \mu_0 (\mathbf{B}_A^e - \mathbf{I})$$

where $\boldsymbol{\tau}_A = J_A \boldsymbol{\sigma}_A$ is the Kirchhoff stress tensor of Part A and $J_A^e = \sqrt{\det \mathbf{B}_A^e} = J_A$ is the Jacobian determinant. The elastic left Cauchy-Green deformation tensor is given by $\mathbf{B}_A^e = \mathbf{F}_A^e \cdot \mathbf{F}_A^{eT}$.

The flow rule is defined by

$$\mathbf{L}_A^p = \dot{\gamma}_A^p \mathbf{N}_A$$

where

$$\mathbf{N}_A = \frac{1}{\sqrt{2} \tau_A} \boldsymbol{\tau}_A^{\text{dev}}, \quad \tau_A = \sqrt{\frac{1}{2} \text{tr}(\boldsymbol{\tau}_A^{\text{dev}})^2}$$

and $\boldsymbol{\tau}_A^{\text{dev}}$ is the stress deviator. The rate of flow is taken to be a thermally activated process

$$\dot{\gamma}_A^p = \dot{\gamma}_{0A} \exp \left[-\frac{\Delta G(1 - \tau_A/s)}{k\theta} \right]$$

where $\dot{\gamma}_{0A}$ is a pre-exponential factor, ΔG is the energy barrier to flow, s is the shear resistance, k is the Boltzmann constant and θ is the absolute temperature. The shear resistance s is assumed to depend on the stress triaxiality σ^* ,

$$s = s(\sigma^*), \quad \sigma^* = \frac{\text{tr } \sigma_A}{3\sqrt{3}\tau_A}$$

The exact dependence is given by a user-defined load curve, which is linear between the shear resistances in compression and tension. These resistances are denoted s_c and s_t , respectively.

Part B: Network resistance:

The network resistance is assumed to be nonlinear elastic with deformation gradient $\mathbf{F}_B = \mathbf{F}_B^N$, i.e. any viscoplastic deformation of the network is neglected. The stress-stretch relation is defined by

$$\boldsymbol{\tau}_B = \frac{nk\theta}{3} \frac{\sqrt{N}}{\bar{\lambda}_N} \mathcal{L}^{-1} \left(\frac{\bar{\lambda}_N}{\sqrt{N}} \right) (\bar{\mathbf{B}}_B^N - \bar{\lambda}_N^2 \mathbf{I})$$

where $\tau_B = J_B \sigma_B$ is the Kirchhoff stress for Part B, n is the chain density and N the number of 'rigid links' between entanglements. In accordance with Boyce et. al [2000], the product, $nk\theta$ is denoted C_R herein. Moreover, \mathcal{L}^{-1} is the inverse Langevin function, $\mathcal{L}(\beta) = \coth\beta - 1/\beta$, and further

$$\bar{\mathbf{B}}_B^N = \bar{\mathbf{F}}_B^N \cdot \bar{\mathbf{F}}_B^{N^T}, \quad \bar{\mathbf{F}}_B^N = J_B^{-1/3} \mathbf{F}_B^N, \quad J_B = \det \mathbf{F}_B^N, \quad \bar{\lambda}_N = \left[\frac{1}{3} \text{tr } \bar{\mathbf{B}}_B^N \right]^{\frac{1}{2}}$$

The flow rule defining the rate of molecular relaxation reads

$$\mathbf{L}_B^F = \dot{\gamma}_B^F \mathbf{N}_B$$

where

$$\mathbf{N}_B = \frac{1}{\sqrt{2}} \frac{\boldsymbol{\tau}_B^{\text{dev}}}{\tau_B}, \quad \tau_B = \sqrt{\frac{1}{2} \boldsymbol{\tau}_B^{\text{dev}} : \boldsymbol{\tau}_B^{\text{dev}}}$$

The rate of relaxation is taken equal to

$$\dot{\gamma}_B^F = C \left(\frac{1}{\bar{\lambda}_F - 1} \right) \tau_B$$

where

$$\bar{\lambda}_F = \left[\frac{1}{3} \text{tr} \left(\mathbf{F}_B^F \{ \mathbf{F}_B^F \}^T \right) \right]^{\frac{1}{2}}$$

The model has been implemented into LS-DYNA using a semi-implicit stress-update scheme [Moran et. al 1990], and is available for the explicit solver only.

***MAT_ARUP_ADHESIVE**

This is Material Type 169. This material model was written for adhesive bonding in aluminum structures. The plasticity model is not volume-conserving, and hence avoids the spuriously high tensile stresses that can develop if adhesive is modeled using traditional elasto-plastic material models. It is available **only** for solid elements of formulations 1, 2 and 15. The smallest dimension of the element is assumed to be the through-thickness dimension of the bond, unless THKDIR = 1.

Card 1	1	2	3	4	5	6	7	8
Variable	MID	RO	E	PR	TENMAX	GCTEN	SHRMAX	GCSHR
Type	A8	F	F	F	F	F	F	F
Default	none	none	none	none	1.e20	1.e20	1.e20	1.e20

Card 2	1	2	3	4	5	6	7	8
Variable	PWRT	PWRS	SHRP	SHT_SL	EDOT0	EDOT2	THKDIR	EXTRA
Type	F	F	F	F	F	F	F	F
Default	2.0	2.0	0.0	0.0	1.0	0.0	0.0	0.0

Additional card for Extra = 1 or 3.

Card 3	1	2	3	4	5	6	7	8
Variable	TMAXE	GCTE	SMAXE	GCSE	PWRTE	PWRSE		
Type	F	F	F	F	F	F		
Default	1.e20	1.e20	1.e20	1.e20	2.0	2.0		

Additional card for Extra = 1 or 3.

Card 4	1	2	3	4	5	6	7	8
Variable	FACET	FACCT	FACES	FACCS	SOFTT	SOFTS		
Type	F	F	F	F	F	F		
Default	1.0	1.0	1.0	1.0	1.0	1.0		

Dynamic Strain Rate Card. Additional card for EDOT2 ≠ 0.

Card 5	1	2	3	4	5	6	7	8
Variable	SDFAC	SGFAC	SDEFAC	SGEFAC				
Type	F	F	F	F				
Default	1.0	1.0	1.0	1.0				

Bond Thickness Card. Additional card for Extra = 2 or 3.

Card 6	1	2	3	4	5	6	7	8
Variable	BTHK	OUTFAIL						
Type	F	F						
Default	0.0	0.0						

VARIABLE

DESCRIPTION

- MID Material identification. A unique number or label not exceeding 8 characters must be specified.
- RO Mass density.
- E Young’s modulus.
- PR Poisson’s ratio.

VARIABLE	DESCRIPTION
TENMAX	Maximum through-thickness tensile stress
GCTEN	Energy per unit area to fail the bond in tension
SHRMAX	Maximum through-thickness shear stress
GCSHR	Energy per unit area to fail the bond in shear
PWRT	Power law term for tension
PWRS	Power law term for shear
SHRP	Shear plateau ratio (Optional)
SHT_SL	Slope (non-dimensional) of yield surface at zero tension (See Remarks)
EDOT0	Strain rate at which the “static” properties apply
EDOT2	Strain rate at which the “dynamic” properties apply (Card 5)
THKDIR	Through-thickness direction flag (See remarks) EQ.0.0: smallest element dimension (default) EQ.1.0: direction from nodes 1-2-3-4 to nodes 5-6-7-8
EXTRA	Flag to input further data: EQ.1.0: interfacial failure properties (cards 3 and 4) EQ.2.0: bond thickness and more (card 6) EQ.3.0: both of the above
TMAXE	Maximum tensile force per unit length on edges of joint
GCTE	Energy per unit length to fail the edge of the bond in tension
SMAXE	Maximum shear force per unit length on edges of joint
GCSE	Energy per unit length to fail the edge of the bond in shear
PWRTE	Power law term for tension
PWRSE	Power law term for shear
FACET	Stiffness scaling factor for edge elements – tension

VARIABLE	DESCRIPTION
FACCT	Stiffness scaling factor for interior elements – tension
FACES	Stiffness scaling factor for edge elements – shear
FACCS	Stiffness scaling factor for interior elements – shear
SOFTT	Factor by which the tensile strength is reduced when a neighbor fails
SOFTS	Factor by which the shear strength is reduced when a neighbor fails
SDFAC	Factor on TENMAX and SHRMAX at strain rate EDOT2
SGFAC	Factor on GCTEN and GCSHR at strain rate EDOT2
SDEFAC	Factor on TMAXE and SMAXE at strain rate EDOT2
SDGFAC	Factor on GCTE and GCSE at strain rate EDOT2
BTHK	Bond thickness (overrides thickness from element dimensions) LT.0.0: BTHK is bond thickness, but critical time step remains unaffected. Helps to avoid very small time steps, but it can affect stability.
OUTFAIL	Flag for additional output to messag file: Information about damage initiation time, failure function terms and forces. EQ.0.0: off EQ.1.0: on

Remarks:

The through-thickness direction is identified from the smallest dimension of each element by default (THKDIR = 0.0). It is expected that this dimension will be smaller than in-plane dimensions (typically 1-2mm compared with 5-10mm). If this is not the case, one can set the through-thickness direction via element numbering (THKDIR = 1.0). Then the thickness direction is expected to point from lower face (nodes 1-2-3-4) to upper face (nodes 5-6-7-8). For wedge elements these faces are the two triangular faces (nodes 1-2-5) and (nodes 3-4-6).

The bond thickness is assumed to be the element size in the thickness direction. This may be overridden using BTHK. In this case the behavior becomes independent of the element thickness. The elastic stiffness is affected by BTHK, so it is necessary to set the characteristic

element length to a smaller value: $l_e^{new} = \sqrt{BTHK \times l_e^{old}}$. This again affects the critical time step of the element, i.e. a small BTHK can decrease the element time step significantly.

In-plane stresses are set to zero: it is assumed that the stiffness and strength of the substrate is large compared with that of the adhesive, given the relative thicknesses.

If the substrate is modeled with shell elements, it is expected that these will lie at the mid-surface of the substrate geometry. Therefore the solid elements representing the adhesive will be thicker than the actual bond. If the elastic compliance of the bond is significant, this can be corrected by increasing the elastic stiffness property E.

The yield and failure surfaces are treated as a power-law combination of direct tension and shear across the bond:

$$\left(\frac{\sigma}{\sigma_{max}}\right)^{PWRT} + \left(\frac{\tau}{\tau_{max} - SHT_SL \times \sigma}\right)^{PWRS} = 1.0$$

At yield SHT_SL is the slope of the yield surface at $\sigma = 0$.

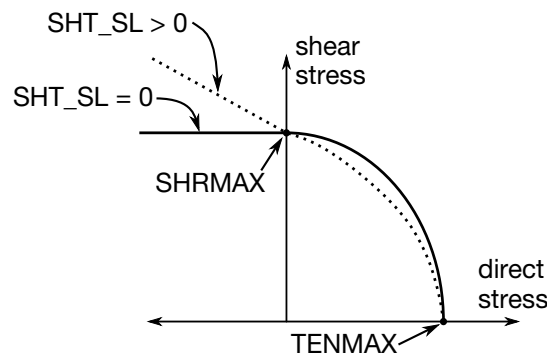

Figure 2-88. Figure illustrating the yield surface.

The stress-displacement curves for tension and shear are shown in the diagrams below. In both cases, Gc is the area under the curve.

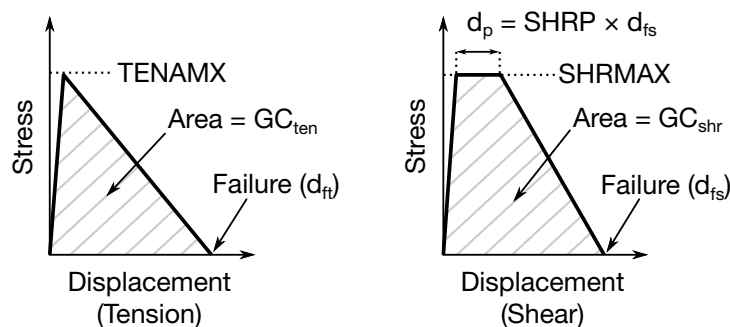

Figure 2-89. Stress-Displacement Curves for Tension and Shear.

Because of the algorithm used, yielding in tension across the bond does not require strains in the plane of the bond – unlike the plasticity models, plastic flow is not treated as volume-conserving.

The Plastic Strain output variable has a special meaning:

- 0 < PS < 1: ps is the maximum value of the yield function experienced since time zero
- 1 < PS < 2: the element has yielded and the strength is reducing towards failure – yields at ps = 1, fails at ps = 2.

The damage cause by cohesive deformation (0 at first yield to 1 at failure) and by interfacial deformation are stored in the first two extra history variables. These can be plotted if NEIPH on *DATABASE_EXTENT_BINARY is 2 or more. By this means, the reasons for failure may be assessed.

When the plastic strain rate rises above EDOT0, rate effects are assumed to scale with log(plastic strain rate), as in the example below for cohesive tensile strength with dynamic factor SDFAC. The same form of relationship is applied for the other dynamic factors. If EDOT0 is zero or blank, no rate effects are applied.

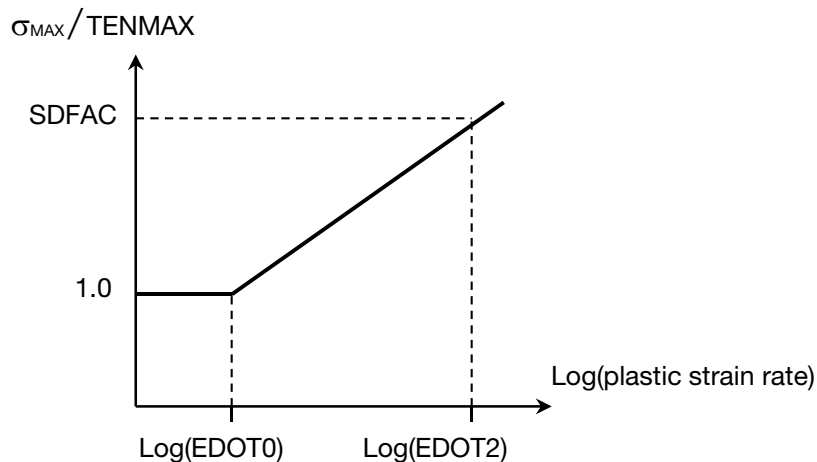

Figure 2-90. Figure illustrating rate effects.

Rate effects are applied using the viscoplastic method.

Interfacial failure is assumed to arise from stress concentrations at the edges of the bond – typically the strength of the bond becomes almost independent of bond length. This type of failure is usually more brittle than cohesive failure. To simulate this, LS-DYNA identifies the free edges of the bond (made up of element faces that are not shared by other elements of material type *MAT_ARUP_ADHESIVE, excluding the faces that bond to the substrate). Only these elements can fail initially. The neighbors of failed elements can then develop

free edges and fail in turn. In real adhesive bonds, the stresses at the edges can be concentrated over very small areas; in typical finite element models the elements are much too large to capture this. Therefore the concentration of loads onto the edges of the bond is accomplished artificially, by stiffening elements containing free edges (e.g. FACET, FACES > 1) and reducing the stiffness of interior elements (e.g. FACCT, FACCS < 1). Interior elements are allowed to yield at reduced loads (equivalent to TMAXE × FACET/FACCT and SMAXE × FACES/FACCS) – this is to prevent excessive stresses developing before the edge elements have failed - but cannot be damaged until they become edge elements after the failure of their neighbors.

***MAT_RESULTANT_ANISOTROPIC**

This is Material Type 170. This model is available the Belytschko-Tsay and the C0 triangular shell elements and is based on a resultant stress formulation. In-plane behavior is treated separately from bending in order to model perforated materials such as television shadow masks. The plastic behavior of each resultant is specified with a load curve and is completely uncoupled from the other resultants. If other shell formulations are specified, the formulation will be automatically switched to Belytschko-Tsay. As implemented, this material model cannot be used with user defined integration rules.

Card 1	1	2	3	4	5	6	7	8
Variable	MID	R0						
Type	A8	F						

Card 2	1	2	3	4	5	6	7	8
Variable	E11P	E22P	V12P	V21P	G12P	G23P	G31P	
Type	F	F	F	F	F	F	F	

Card 3	1	2	3	4	5	6	7	8
Variable	E11B	E22B	V12B	V21B	G12B	AOPT		
Type	F	F	F	F	F	F		

Card 4	1	2	3	4	5	6	7	8
Variable	LN11	LN22	LN12	LQ1	LQ2	LM11	LM22	LM12
Type	F	F	F	F	F	F	F	F

Card 5	1	2	3	4	5	6	7	8
Variable				A1	A2	A3		
Type				F	F	F		

Card 6	1	2	3	4	5	6	7	8
Variable	V1	V2	V3	D1	D2	D3	BETA	
Type	F	F	F	F	F	F	F	

VARIABLE**DESCRIPTION**

MID	Material identification. A unique number or label not exceeding 8 characters must be specified.
RO	Mass density.
E11P	E_{11p} , for in plane behavior.
E22P	E_{22p} , for in plane behavior.
V12P	v_{12p} , for in plane behavior.
V11P	v_{21p} , for in plane behavior.
G12P	G_{12p} , for in plane behavior.
G23P	G_{23p} , for in plane behavior.
G31P	G_{31p} , for in plane behavior.
E11B	E_{11b} , for bending behavior.
E22B	E_{22b} , for bending behavior.
V12B	v_{12b} , for bending behavior.
V21B	v_{21b} , for bending behavior.
G12B	G_{12b} , for bending behavior.
AOPT	Material axes option (see MAT_OPTIONTROPIC_ELASTIC for a

VARIABLE	DESCRIPTION
	more complete description):
	EQ.0.0: locally orthotropic with material axes determined by element nodes 1, 2, and 4, as with *DEFINE_COORDINATE_NODES, and then rotated about the shell element normal by the angle BETA.
	EQ.2.0: globally orthotropic with material axes determined by vectors defined below, as with *DEFINE_COORDINATE_VECTOR.
	EQ.3.0: locally orthotropic material axes determined by rotating the material axes about the element normal by an angle, BETA, from a line in the plane of the element defined by the cross product of the vector \mathbf{v} with the element normal.
	LT.0.0: the absolute value of AOPT is a coordinate system ID number (CID on *DEFINE_COORDINATE_NODES, *DEFINE_COORDINATE_SYSTEM or *DEFINE_COORDINATE_VECTOR). Available in R3 version of 971 and later.
LN11	Yield curve ID for N_{11} .
LN22	Yield curve ID for N_{22} .
LN12	Yield curve ID for N_{12} .
LQ1	Yield curve ID for Q_1 .
LQ2	Yield curve ID for Q_2 .
LM11	Yield curve ID for M_{11} .
LM22	Yield curve ID for M_{22} .
LM12	Yield curve ID for M_{12} .
A1, A2, A3	$a_1 a_2 a_3$, define components of vector \mathbf{a} for AOPT = 2.
V1, V2, V3	$v_1 v_2 v_3$, define components of vector \mathbf{v} for AOPT = 3.
D1, D2, D3	$d_1 d_2 d_3$, define components of vector \mathbf{d} for AOPT = 2.
BETA	Material angle in degrees for AOPT = 0 and 3, may be overridden on the element card, see *ELEMENT_SHELL_BETA.

Remarks:

The in-plane elastic matrix for in-plane, plane stress behavior is given by:

$$C_{\text{in plane}} = \begin{bmatrix} Q_{11p} & Q_{12p} & 0 & 0 & 0 \\ Q_{12p} & Q_{22p} & 0 & 0 & 0 \\ 0 & 0 & Q_{44p} & 0 & 0 \\ 0 & 0 & 0 & Q_{55p} & 0 \\ 0 & 0 & 0 & 0 & Q_{66p} \end{bmatrix}$$

The terms Q_{ijp} are defined as:

$$Q_{11p} = \frac{E_{11p}}{1 - \nu_{12p}\nu_{21p}}$$

$$Q_{22p} = \frac{E_{22p}}{1 - \nu_{12p}\nu_{21p}}$$

$$Q_{12p} = \frac{\nu_{12p}E_{11p}}{1 - \nu_{12p}\nu_{21p}}$$

$$Q_{44p} = G_{12p}$$

$$Q_{55p} = G_{23p}$$

$$Q_{66p} = G_{31p}$$

The elastic matrix for bending behavior is given by:

$$C_{\text{bending}} = \begin{bmatrix} Q_{11b} & Q_{12b} & 0 \\ Q_{12b} & Q_{22b} & 0 \\ 0 & 0 & Q_{44b} \end{bmatrix}$$

The terms Q_{ijp} are similarly defined.

***MAT_STEEL_CONCENTRIC_BRACE**

This is Material Type 171. It represents the cyclic buckling and tensile yielding behavior of steel braces and is intended primarily for seismic analysis. Use only for beam elements with ELFORM = 2 (Belytschko-Schwer beam).

Card 1	1	2	3	4	5	6	7	8
Variable	MID	RO	YM	PR	SIGY	LAMDA	FBUCK	FBUCK2
Type	A8	F	F	F	F	F	F	F
Default	none	none	none	none	none	See Remarks	See Remarks	0.0

Card 2	1	2	3	4	5	6	7	8
Variable	CCBRF	BCUR						
Type	F	F						
Default	See Remarks							

Card 3	1	2	3	4	5	6	7	8
Variable	TS1	TS2	TS3	TS4	CS1	CS2	CS3	CS4
Type	F	F	F	F	F	F	F	F
Default	0	0	0	0	= TS1	= TS2	= TS3	= TS4

VARIABLE**DESCRIPTION**

MID	Material identification. A unique number or label not exceeding 8 characters must be specified.
RO	Mass density

VARIABLE	DESCRIPTION
YM	Young's Modulus
PR	Poisson's Ratio
SIGY	Yield stress
LAMDA	Slenderness ratio (optional – see note)
FBUCK	Initial buckling load (optional – see note. If used, should be positive)
FBUCK2	Optional extra term in initial buckling load – see note
CCBRF	Reduction factor on initial buckling load for cyclic behavior
BCUR	Optional load curve giving compressive buckling load (y-axis) versus compressive strain (x-axis - both positive)
TS1 - TS4	Tensile axial strain thresholds 1 to 4
CS1 - CS4	Compressive axial strain thresholds 1 to 4

Remarks:

The brace element is intended to represent the buckling, yielding and cyclic behavior of steel elements such as tubes or I-sections that carry only axial loads. Empirical relationships are used to determine the buckling and cyclic load-deflection behavior. A single beam element should be used to represent each structural element.

The cyclic behavior is shown in the graph (compression shown as negative force and displacement).

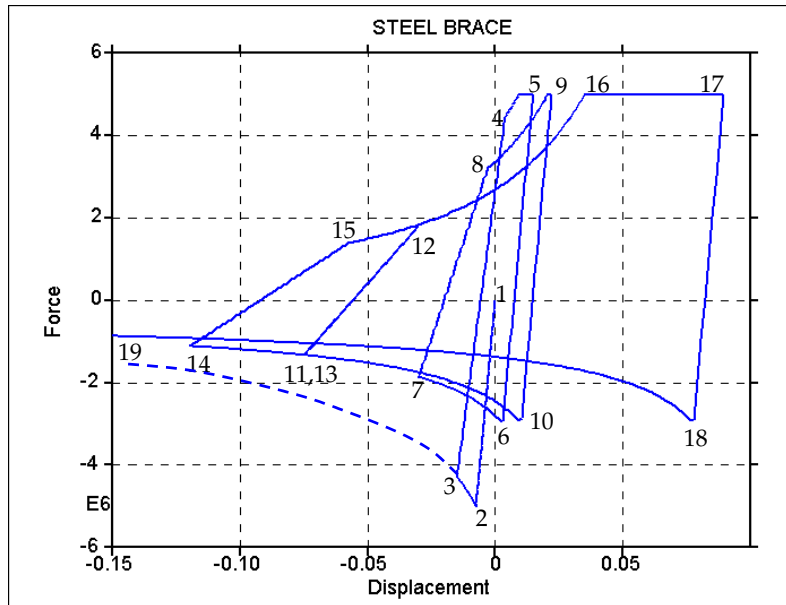

Figure 2-91.

The initial buckling load (point 2) is:

$$F_{b \text{ initial}} = \text{FBUCK} + \frac{\text{FBUCK2}}{L^2 F(d)} = \frac{F_{b \text{ initial}}}{\sqrt{A\delta + B}}$$

where FBUCK, FBUCK2 are input parameters and L is the length of the beam element. If neither FBUCK nor FBUCK2 are defined, the default is that the initial buckling load is

$$\text{SIGY} \times A,$$

where A is the cross sectional area. The buckling curve (shown dashed) has the form:

$$F(d) = \frac{F_{b \text{ initial}}}{\sqrt{A\delta + B}}$$

where δ is abs(strain/yield strain), and A and B are internally-calculated functions of slenderness ratio (λ) and loading history.

The member slenderness ratio λ is defined as $\frac{kL}{r}$, where k depends on end conditions, L is the element length, and r is the radius of gyration such that $Ar^2 = I$ (and $I = \min(I_{yy}, I_{zz})$); λ will by default be calculated from the section properties and element length using $k = 1$. Optionally, this may be overridden by input parameter LAMDA to allow for different end conditions.

Optionally, the user may provide a buckling curve BCUR. The points of the curve give compressive displacement (x-axis) versus force (y-axis); the first point should have zero displacement and the initial buckling force. Displacement and force should both be positive. The initial buckling force must not be greater than the yield force.

The tensile yield force (point 5 and section 16-17) is defined by

$$F_y = \text{SIGY} \times A,$$

where yield stress SIGY is an input parameter and A is the cross-sectional area.

Following initial buckling and subsequent yield in tension, the member is assumed to be damaged. The initial buckling curve is then scaled by input parameter CCBRF, leading to reduced strength curves such as segments 6-7, 10-14 and 18-19. This reduction factor is typically in the range 0.6 to 1.0 (smaller values for more slender members). By default, CCBRF is calculated using SEAOC 1990:

$$\text{CCBRF} = \frac{1}{\left(1 + \frac{0.5\lambda}{\pi \sqrt{\frac{E}{0.5\sigma_y}}}\right)}$$

When tensile loading is applied after buckling, the member must first be straightened before the full tensile yield force can be developed. This is represented by a reduced unloading stiffness (e.g. segment 14-15) and the tensile reloading curve (segments 8-9 and 15-16). Further details can be found in Bruneau, Uang, and Whittaker [1998] and Structural Engineers Association of California [1974, 1990, 1996].

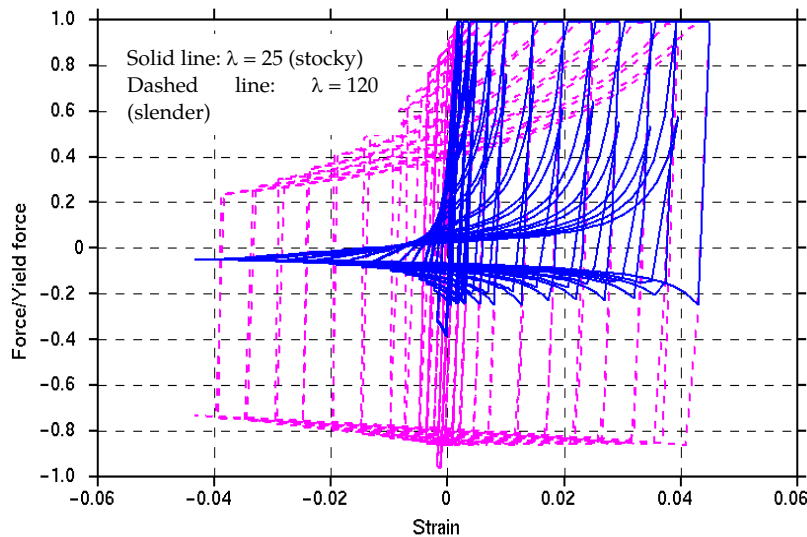

Figure 2-92.

The response of stocky (low λ) and slender (high λ) braces are compared in the graph. These differences are achieved by altering the input value LAMDA (or the section properties of the beam) and FBUCK.

Output:

Axial Strain and Internal Energy may be plotted from the INTEGRATED beam results menus in Oasys Ltd. Post processors: D3PLOT and T/HIS.

FEMA thresholds are the total axial strains (defined by change of length/initial length) at which the element is deemed to have passed from one category to the next, e.g. "Elastic", "Immediate Occupancy", "Life Safe", etc. During the analysis, the maximum tensile and compressive strains ("high tide strains") are recorded. These are checked against the user-defined limits TS1 to TS4 and CS1 to CS4. The output flag is then set to 0, 1, 2, 3, or 4 according to which limits have been passed. The value in the output files is the highest such flag from tensile or compressive strains. To plot this data, select INTEGRATED beam results, Integration point 4, Axial Strain.

Maximum plastic strains in tension and compression are also output. These are defined as maximum total strain to date minus the yield or first buckling strain for tensile and compressive plastic strains respectively. To plot these, select INTEGRATED beam results, Integration point 4, "shear stress XY" and "shear stress XZ" for tensile and compressive plastic strains, respectively.

***MAT_CONCRETE_EC2**

This is Material Type 172, for shell and Hughes-Liu beam elements only. The material model can represent plain concrete only, reinforcing steel only, or a smeared combination of concrete and reinforcement. The model includes concrete cracking in tension and crushing in compression, and reinforcement yield, hardening and failure. Properties are thermally sensitive; the material model can be used for fire analysis. Material data and equations governing the behavior (including thermal properties) are taken from Eurocode 2 Part 1.2 (General rules – Structural fire design), hereafter referred to as EC2. Although the material model offers many options, a reasonable response may be obtained by entering only RO, FC and FT for plain concrete; if reinforcement is present, YMREINF, SUREINF, FRACRX, FRACRY must be defined.

Card 1	1	2	3	4	5	6	7	8
Variable	MID	RO	FC	FT	TYPEC	UNITC	ECUTEN	FCC6
Type	A8	F	F	F	F	F	F	F
Default	none	none	none	0.0	1.0	1.0	0.0025	FC

Card 2	1	2	3	4	5	6	7	8
Variable	ESOFT	LCHAR	MU	TAUMXF	TAUMXC	ECRAGG	AGGSZ	UNITL
Type	F	F	F	F	F	F	F	F
Default	See notes	0.0	0.4	1.E20	1.161 × FT	.001	0.0	1.0

Card 3	1	2	3	4	5	6	7	8
Variable	YMREINF	PRREINF	SUREINF	TYPER	FRACRX	FRACY	LCRSU	LCALPS
Type	F	F	F	F	F	F	I	I
Default	none	0.0	0.0	1.0	0.0	0.0	none	none

Card 4	1	2	3	4	5	6	7	8
Variable	AOPT	ET36	PRT36	ECUT36	LCALPC	DEGRAD	ISHCHK	UNLFAC
Type	F	F	F	F	I	F	I	F
Default	0.0	0.0	0.25	1.E20	none	0.0	0	0.5

Additional card for AOPT > 0.

Card 5	1	2	3	4	5	6	7	8
Variable	XP	YP	ZP	A1	A2	A3		
Type	F	F	F	F	F	F		
Default	0.0	0.0	0.0	0.0	0.0	0.0		

Additional card for AOPT > 0.

Card 6	1	2	3	4	5	6	7	8
Variable	V1	V2	V3	D1	D2	D3	BETA	
Type	F	F	F	F	F	F	F	
Default	0.0	0.0	0.0	0.0	0.0	0.0	0.0	

Omit if ISHCHK = 0

Card 7	1	2	3	4	5	6	7	8
Variable	TYPSEC	P_OR_F	EFFD	GAMSC				
Type	F	F	F	F				
Default	0.0	0.0	0.0	0.0				

Additional card for TYPEC = 6.

REQ N	1	2	3	4	5	6	7	8
Variable	ECI_6	ECSP_6						
Type	F	F						
Default	see notes	see notes						

VARIABLE**DESCRIPTION**

MID	Material identification. A unique number or label not exceeding 8 characters must be specified.
RO	Mass density
FC	Compressive strength of concrete (stress units)
FT	Tensile stress to cause cracking

VARIABLE	DESCRIPTION
TYPEC	Concrete aggregate type for stress-strain-temperature relationships EQ.1.0: Siliceous (default), relationships from Draft EC2 ANNEX EQ.2.0: Calcareous, relationships from Draft EC2 ANNEX EQ.3.0: Non-thermally-sensitive using ET3, ECU3 EQ.4.0: Lightweight EQ.5.0: Fiber-reinforced EQ.6.0: Non-thermally-sensitive, Mander algorithm EQ.7.0: Siliceous, relationships from EC2 2004 EQ.8.0: Calcareous, relationships from EC2 2004
UNITC	Factor to convert stress units to MPa (used in shear capacity checks) e.g. if model units are Newtons and metres, UNITC = 1E-6
ECUTEN	Strain to fully open a crack.
FCC6	Compressive strength of confined concrete (type 6). If blank, unconfined properties are assumed.
ESOFT	Tension stiffening (Slope of stress-strain curve post-cracking in tension)
MU	Friction on crack planes (max shear = μ *compressive stress)
TAUMXF	Maximum friction shear stress on crack planes (ignored if AGGSZ > 0 - see notes).
TAUMXC	Maximum through-thickness shear stress after cracking (see notes).
ECRAGG	Strain parameter for aggregate interlock (ignored if AGGSZ > 0 - see notes).
AGGSZ	Aggregate size (length units - used in NS3473 aggregate interlock formula - see notes).
UNITL	Factor to convert length units to millimeters (used only if AGGSZ > 0 - see notes) e.g. if model unit is meters, UNITL = 1000.
LCHAR	Characteristic length at which ESOFT applies, also used as crack spacing in aggregate-interlock calculation
YMREINF	Young's Modulus of reinforcement

VARIABLE	DESCRIPTION
PRREINF	Poisson's Ratio of reinforcement
SUREINF	Ultimate stress of reinforcement
TYPER	Type of reinforcement for stress-strain-temperature relationships EQ.1.0: Hot rolled reinforcing steel, from Draft EC2 Annex EQ.2.0: Cold worked reinforcing steel (default), from Draft EC2 EQ.3.0: Quenched and tempered prestressing steel EQ.4.0: Cold worked prestressing steel EQ.5.0: Non-thermally sensitive using loadcurve LCRSU. EQ.7.0: Hot rolled reinforcing steel, from EC2 2004 EQ.8.0: Cold worked reinforcing steel, from EC2 2004
FRACRX	Fraction of reinforcement (x-axis) (e.g. for 1% reinforcement FRACR = 0.01).
FRACRY	Fraction of reinforcement (y-axis) (e.g. for 1% reinforcement FRACR = 0.01).
LCRSU	Loadcurve for TYPER = 5, giving non-dimensional factor on SUREINF versus plastic strain (overrides stress-strain relationships from EC2).
LCALPS	Optional loadcurve giving thermal expansion coefficient of reinforcement vs temperature – overrides relationship from EC2.
AOPT	Option for local orthotropic axes – see Material Type 2 EQ.0.0: locally orthotropic with material axes determined by element nodes as shown in Figure 2-3 . Nodes 1, 2, and 4 of an element are identical to the nodes used for the definition of a coordinate system as by *DEFINE_COORDINATE_NODES. When this option is used in two-dimensional planar and axisymmetric analysis, it is critical that the nodes in the element definition be numbered counterclockwise for this option to work correctly. EQ.1.0: locally orthotropic with material axes determined by a point in space and the global location of the element center; this is the a-direction. This option is for solid elements only. EQ.2.0: globally orthotropic with material axes determined by

VARIABLE	DESCRIPTION
	vectors defined below, as with *DEFINE_COORDINATE_VECTOR.
	EQ.3.0: locally orthotropic material axes determined by rotating the material axes about the element normal by an angle, BETA, from a line in the plane of the element defined by the cross product of the vector v with the element normal. The plane of a solid element is the midsurface between the inner surface and outer surface defined by the first four nodes and the last four nodes of the connectivity of the element, respectively.
	LT.0.0: This option has not yet been implemented for this material model.
ET36	Youngs Modulus of concrete (TYPEC = 3 and 6).
PRT36	Poissons Ratio of concrete (TYPEC = 3 and 6).
ECUT36	Strain to failure of concrete in compression ϵ_{cu} (TYPEC = 3 and 6).
LCALPC	Optional loadcurve giving thermal expansion coefficient of concrete vs temperature – overrides relationship from EC2.
DEGRAD	If non-zero, the compressive strength of concrete parallel to an open crack will be reduced (see notes).
ISHCHK	Flag = 1 to input data for shear capacity check.
UNLFAC	Stiffness degradation factor after crushing (0.0 to 1.0 – see notes).
XP, YP, ZP	Coordinates of point p for AOPT = 1 and 4 (see Mat type 2).
A1, A2, A3	Components of vector a for AOPT = 2 (see Mat type 2).
V1, V2, V3	Components of vector v for AOPT = 3 and 4 (see Mat type 2).
D1, D2, D3	Components of vector d for AOPT = 2 (see Mat type 2).
TYPESC	Type of shear capacity check EQ.1.0: BS 8110 EQ.2.0: ACI
P_OR_F	If BS8110 shear check, percent reinforcement – e.g. if 0.5%, input 0.5. If ACI shear check, ratio (cylinder strength/FC) - defaults to 1.

VARIABLE	DESCRIPTION
EFFD	Effective section depth (length units), used in shear capacity check. This is usually the section depth excluding the cover concrete.
GAMSC	Load factor used in BS8110 shear capacity check.
EC1_6	Strain at maximum compressive stress for Type 6 concrete.
ECSP_6	Spalling strain in compression for Type 6 concrete.

Remarks:

Reinforcement is treated as separate sets of bars in the local element x and y axes. The reinforcement is assumed not to carry through-thickness or in-plane shear.

The material model is thermally-sensitive. If no temperatures are defined in the model, it behaves as if at 20degC. Pre-programmed relationships between temperature and concrete properties (compressive strength, strain at maximum compressive stress ec1, ultimate strain ecu) are by default taken from the Annex to the draft EC2 document (ENV 1992-1-2:1995), but when the standard was released in 2004 (EN 1992-1-2:2004 (E)) some of the recommended data had changed. The 2004 data is available by setting concrete type 7 or 8.

Creating Reinforced Concrete Sections:

This material model can be used to represent unreinforced concrete (FRACR = 0), steel (FRACR = 1), or reinforced concrete with evenly distributed reinforcement ($0 < \text{FRACR} < 1$).

Alternatively, use *INTEGRATION_SHELL or *PART_COMPOSITE to define the section. Create one material Part for concrete and another for steel, both of type MAT_CONCRETE_EC2, one with FRACR = 0 (representing the concrete), the other with FRACR = 1 (reinforcement bars). Each integration point may then be defined as either concrete or steel as appropriate.

Material Behavior:

Stress-strain curves for concrete and steel (and their variation with temperature) are as specified in EC2, scaled to the user-supplied FC, FT and SUREINF. Thermal expansion coefficients as functions of temperature are by default taken from EC2. These can optionally be overwritten using LCALPC, LCALPS.

The concrete is assumed to crack in tension when the maximum in-plane principal stress (bending+membrane stress at an integration point) reaches FT. Cracks can open and close repeatedly under hysteretic loading. When a crack is closed it can carry compression

according to the normal compressive stress-strain relationships. The direction of the crack relative to the element coordinate system is stored when the crack first forms. The material can carry compression parallel to the crack even when the crack is open. A second crack may form perpendicular to the initial crack.

After initial cracking, the tensile stress reduces with increasing tensile strain. A finite amount of energy must be absorbed to create a fully open crack - in practice the reinforcement holds the concrete together, allowing it to continue to take some tension (this effect is known as tension-stiffening). The options available for the stress-strain relationship are shown below. The bilinear relationship is used by default. The simple linear relationship applies only if ESOFT > 0 and ECUTEN = 0.

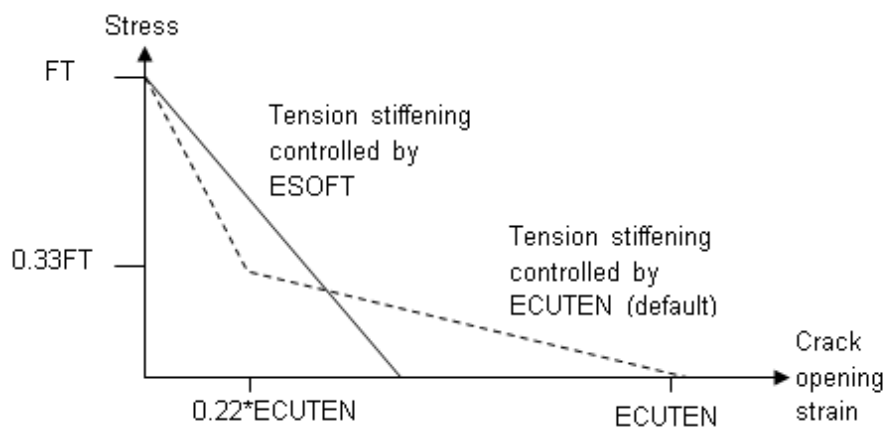

Figure 2-93. Tensile Behaviour of Concrete

LCHAR can optionally be used to maintain constant energy per unit area of crack irrespective of mesh size, i.e. the crack opening displacement is fixed rather than the crack opening strain. $LCHAR \times ECUTEN$ is then the displacement to fully open a crack. For the actual elements, crack opening displacement is estimated by $strain \times \sqrt{area}$. Note that if LCHAR is defined, it is also used as the crack spacing in the NS 3473 aggregate interlock calculation.

The relationship of FT with temperature is taken from EC2 – there is no input option to change this. FT is assumed to remain at its input value at temperatures up to 100 deg C, then to reduce linearly with temperature to zero at 600 deg C. Up to 500 deg C, the crack opening strain ECUTEN increases with temperature such that the fracture energy to open the crack remains constant. Above 500 deg C the crack opening strain does not increase further.

Compressive behaviour of the concrete initially follows a curve defined in EC2 as:

$$\text{Stress} = FC_{\max} \times \left[\left(\frac{\varepsilon}{\varepsilon_{cl}} \right) \times \frac{3}{2 + \left(\frac{\varepsilon}{\varepsilon_{cl}} \right)^3} \right]$$

where ϵ_{c1} is the strain at which the ultimate compressive strength FC_{max} is reached, and ϵ_{cu} is the current equivalent uniaxial compressive strain.

The initial elastic modulus is given by $E = 3FC_{max}/2\epsilon_{c1}$. On reaching FC_{max} , the stress decreases linearly with increasing strain, reaching zero at a strain ϵ_{cu} . Strains ϵ_{c1} and ϵ_{cu} are by default taken from EC2 and are functions of temperature. At 20°C they take values 0.0025 and 0.02 respectively. FC_{max} is also a function of temperature, given by the input parameter FC (which applies at 20°C) times a temperature-dependent softening factor taken from EC2.

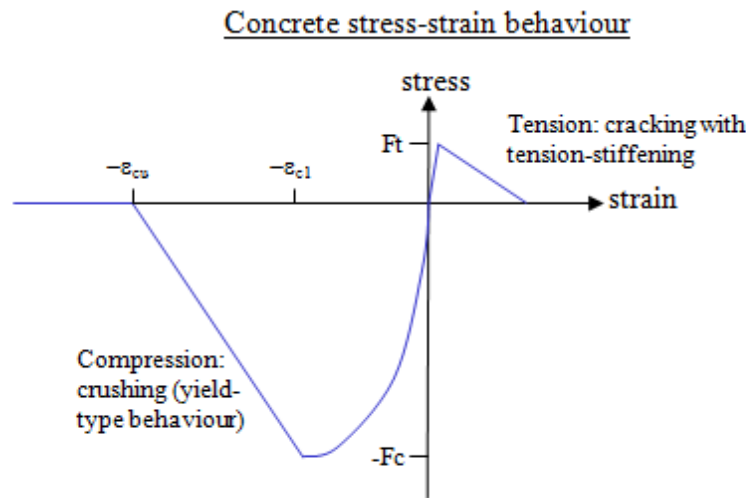

Figure 2-94. Concrete stress strain behavior

For TYPEC = 3, the user over-rides the default values of elastic stiffness and ϵ_{cu} . In this case, the strain ϵ_{c1} is calculated from the elastic stiffness, and there is no thermal sensitivity. The stress-strain behaviour follows the same form as described above.

For TYPEC = 6, the above compressive crushing behaviour is replaced with the equations proposed by Mander. This algorithm can model unconfined or confined concrete; for unconfined, leave FCC6 blank. For confined concrete, input the confined compressive strength as FCC6.

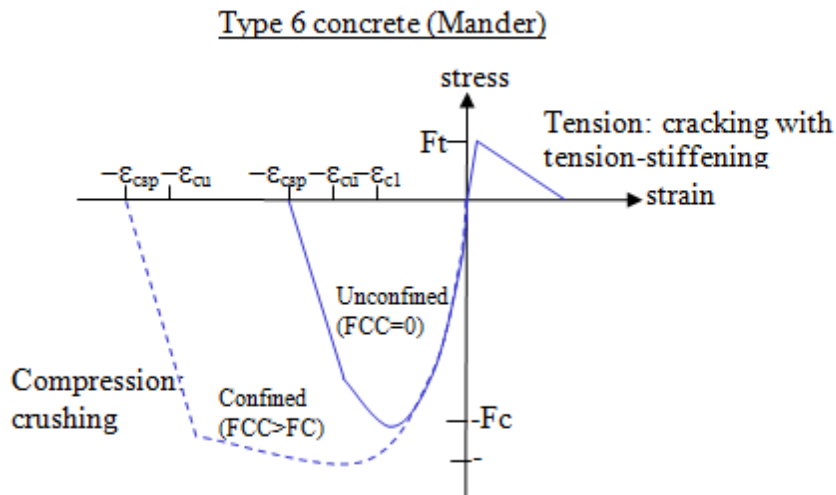

Figure 2-95. Type 6 concrete

Default values for type 6 are calculated as follows:

$$\epsilon_{cl} = 0.002 \times \left[1 + 5 \left(\frac{FCC6}{FC} - 1 \right) \right]$$

$$\epsilon_{cu} = 1.1 \times \epsilon_c$$

$$\epsilon_{csp} = \epsilon_{cu} + \frac{FCC}{E}$$

Note that for unconfined concrete, $FCC6 = FC$ causing ϵ_{cl} to default to 0.002.

Unload/reload stiffness (all concrete types):

During compressive loading, the elastic modulus will be reduced according to the parameter UNLFAC (default = 0.5). UNLFAC = 0.0 means no reduction, i.e. the initial elastic modulus will apply during unloading and reloading. UNLFAC = 1.0 means that unloading results in no permanent strain. Intermediate values imply a permanent strain linearly interpolated between these extremes.

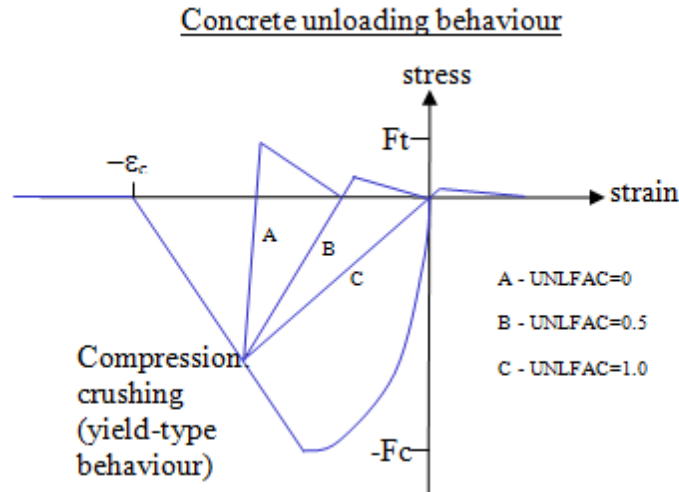

Figure 2-96. Concrete unloading behavior

Tensile strength is reduced by the same factor as the elastic modulus as described in the paragraph above.

Optional compressive strength degradation due to cracking:

By default, the compressive strength of cracked and uncracked elements is the same. If DEGRAD is non-zero, the formula from BS8110 is used to reduce compressive strength parallel to the crack while the crack is open:

$$\text{Reduction factor} = \min \left(1.0, \frac{1.0}{0.8 + 100\epsilon_t} \right),$$

where ϵ_t is the tensile strain normal to the crack.

Through-thickness shear strength:

Before cracking, the through-thickness shear stress in the concrete is unlimited. For cracked elements, shear stress on the crack plane (magnitude of shear stress including element-plane and through-thickness terms) is treated in one of two ways:

1. If $AGGSZ > 0$, the relationship from Norwegian standard NS3473 is used to model the aggregate-interlock that allows cracked concrete to carry shear loading. In this case, UNITL must be defined. This is the factor that converts model length units to millimetres, i.e. the aggregate size in millimetres = $AGGSZ \times UNITL$. The formula in NS3473 also requires the crack width in millimetres: this is estimated from $UNITL \times \epsilon_{cro} \times L_e$, where ϵ_{cro} is the crack opening strain and L_e is the crack spacing, taken as LCHAR if non-zero, or equal to element size if LCHAR is zero. Optionally, TAUMXC may be used to set the maximum shear stress when the crack is closed and the normal stress is zero – by default this is equal to 1.161FT from the

formulae in NS3473. If TAUMXC is defined, the shear stress from the NS3473 formula is scaled by TAUMXC / 1.161FT.

2. If AGGSZ = 0, the aggregate interlock is modeled by this formula:

$$\tau_{\max} = \frac{\text{TAUMXC}}{1.0 + \frac{\varepsilon_{\text{cro}}}{\text{ECRAGG}}} + \min(\text{MU} \times \sigma_{\text{comp}}, \text{TAUMXF})$$

Where τ_{\max} is the maximum shear stress carried across a crack; σ_{comp} is the compressive stress across the crack (this is zero if the crack is open); ECRAGG is the crack opening strain at which the input shear strength TAUMXC is halved. Again, TAUMXC defaults to 1.161FT.

Note that if a shear capacity check is specified, the above applies only to in-plane shear, while the through-thickness shear is unlimited.

The reinforcement is treated as separate bars in the local X and Y directions – it does not carry shear in the local XY direction. At 20°C the behaviour is elastic-perfectly-plastic, up to the onset of failure, after which the stress reduces linearly with increasing strain until final failure. The strain at which failure occurs depend on the reinforcement type (TYPER) and the temperature. For example, for hot-rolled reinforcing steel at 20°C failure begins at 15% strain and is complete at 20% strain.

The default stress-strain curve for reinforcement may be overridden using TYPER = 5 and LCRSU. In this case, the reinforcement properties are not temperature-sensitive and the yield stress is given by SUREINF × f(ε_p), where f(ε_p) is the loadcurve value at the current plastic strain. To include failure of the reinforcement, the curve should reduce to zero at the desired failure strain and remain zero for higher strains. Note that LS-DYNA re-interpolates the input curve to have 100 equally-spaced points; if the last point on the curve is at very high strain, then the initial part of the curve may become poorly defined.

Local directions:

AOPT and associated data are used to define the directions of the reinforcement bars. If the reinforcement directions are not consistent across neighbouring elements, the response may be less stiff than intended – this is equivalent to the bars being bent at the element boundaries. See material type 2 for description of the different AOPT settings.

Shear capacity check:

Shear reinforcement is not included explicitly in this material model. However, a shear capacity check can be made, to show regions that require shear reinforcement. The assumption is that the structure will not yield or fail in through-thickness shear, because sufficient shear reinforcement will be added. Set ISHCHK and TYPESC to 1. Give the percentage

reinforcement (P_OR_F), effective depth of section EFFD (this typically excludes the cover concrete), and load factor GAMSC. These are used in Table 3.8 of BS 8110-1:1997 to determine the design shear stress. The “shear capacity” is this design shear stress times the total section thickness (i.e. force per unit width), modified according to Equation 6b of BS 8110 to allow for axial load. The “shear demand” (actual shear force per unit width) is then compared to the shear capacity. This process is performed for the two local directions of the reinforcement in each element; when defining sections using integration rules and multiple sets of material properties, it is important that each set of material properties referenced within the same section has the same AOPT and orientation data. Note that the shear demand and axial load (used in calculation of the shear capacity) are summed across the integration points within the section; the same values of capacity, demand, and difference between capacity and demand are then written to all the integration points.

Thermal expansion:

By default, thermal expansion properties from EC2 are used. If no temperatures are defined in the model, properties for 20deg C are used. For the user-defined types (TYPEC = 3 or 6, TYPER = 5) there is no thermal expansion by default, and the properties do not vary with temperature. The user may override the default thermal expansion behaviour by defining curves of thermal expansion coefficient versus temperature (LCALPC, LCALPR). These apply no matter what types TYPEC and TYPER have been selected.

Output:

“Plastic Strain” is the maximum of the plastic strains in the reinforcement in the two local directions.

Extra history variables may be requested for shell elements (NEIPS on *DATABASE_EXTENT_BINARY), which have the following meaning:

- | | | |
|----------------|----|--|
| Extra Variable | 1: | Current crack opening strain (if two cracks are present, max of the two) |
| Extra Variable | 2: | Equivalent uniaxial strain for concrete compressive behaviour |
| Extra Variable | 3: | Number of cracks (0, 1 or 2) |
| Extra Variable | 4: | Temperature |
| Extra Variable | 5: | Thermal strain |
| Extra Variable | 6: | Current crack opening strain – first crack to form |
| Extra Variable | 7: | Current crack opening strain – crack at 90 degrees to first crack |
| Extra Variable | 8: | Max crack opening strain – first crack to form |
| Extra Variable | 9: | Max crack opening strain – crack at 90 degrees to first crack |

- Extra Variable 10: Maximum difference (shear demand minus capacity) that has occurred so far, in either of the two reinforcement directions
- Extra Variable 11: Maximum difference (shear demand minus capacity) that has occurred so far, in reinforcement x-direction
- Extra Variable 12: Maximum difference (shear demand minus capacity) that has occurred so far, in reinforcement y-direction
- Extra Variable 13: Current shear demand minus capacity, in reinforcement x-direction
- Extra Variable 14: Current shear demand minus capacity, in reinforcement y-direction
- Extra Variable 15: Current shear capacity V_{cx} , in reinforcement x-direction
- Extra Variable 16: Current shear capacity V_{cy} , in reinforcement y-direction
- Extra Variable 17: Current shear demand V_x , in reinforcement x-direction
- Extra Variable 18: Current shear demand V_y , in reinforcement y-direction
- Extra Variable 19: Maximum shear demand that has occurred so far, in reinforcement x-direction
- Extra Variable 20: Maximum shear demand) that has occurred so far, in reinforcement y-direction
- Extra Variable 21: Current strain in reinforcement (x-direction)
- Extra Variable 22: Current strain in reinforcement (y-direction)
- Extra Variable 23: Shear strain (slip) across first crack
- Extra Variable 24: Shear strain (slip) across second crack
- Extra Variable 25: X-Stress in concrete (element local axes)
- Extra Variable 26: Y-Stress in concrete (element local axes)
- Extra Variable 27: XY-Stress in concrete (element local axes)
- Extra Variable 28: YZ-Stress in concrete (element local axes)
- Extra Variable 29: XZ-Stress in concrete (element local axes)
- Extra Variable 30: Reinforcement stress (A-direction)
- Extra Variable 31: Reinforcement stress (B-direction)
- Extra Variable 32: Current shear demand V_{max}
- Extra Variable 33: Maximum V_{max} that has occurred so far
- Extra Variable 34: Current shear capacity $V_{c\theta}$
- Extra Variable 35: Excess shear = $V_{max} - V_{c\theta}$
- Extra Variable 36: Maximum excess shear that has occurred so far

In the above list V_{\max} is given by

$$V_{\max} = \sqrt{V_x^2 + V_y^2}$$

Where V_x and V_y is the shear demand reinforcement in x and y directions respectively. Additionally,

$$V_{c\theta} = \frac{V_{\max}}{\sqrt{\left(\frac{V_x}{V_{cx}}\right)^2 + \left(\frac{V_y}{V_{cy}}\right)^2}}$$

where V_{cx} , V_{cy} are the shear capacities in the x and y directions.

Note that the concrete stress history variables are stored in element local axes irrespective of AOPT, i.e. local X is always the direction from node 1 to node 2. The reinforcement stresses are in the reinforcement directions; these do take account of AOPT.

MAXINT (shells) and/or BEAMIP (beams) on *DATABASE_EXTENT_BINARY may be set to the maximum number of integration points, so that results for all integration points can be plotted separately.

***MAT_MOHR_COULOMB**

This is Material Type 173 for solid elements only, is intended to represent sandy soils and other granular materials. Joints (planes of weakness) may be added if required; the material then represents rock. The joint treatment is identical to that of *MAT_JOINTED_ROCK.

Card 1	1	2	3	4	5	6	7	8
Variable	MID	RO	GMOD	RNU	(blank)	PHI	CVAL	PSI
Type	A8	F	F	F		F	F	F
Default								0.0

Card 2	1	2	3	4	5	6	7	8
Variable	NOVOID	NPLANES	(blank)	LCCPDR	LCCPT	LCCJDR	LCCJT	LCSFAC
Type	1	I		I	I	I	I	I
Default	0	0		0	0	0	0	0

Card 3	1	2	3	4	5	6	7	8
Variable	GMODDP	GMODGR	LCGMEP	LCPHIEP	LCPSIEP	LCGMST	CVALGR	ANISO
Type	F	F	F	F	F	F	F	F
Default	0.0	0.0	0.0	0.0	0.0	0.0	0.0	1.0

Plane Cards. Repeat for each plane (maximum 6 planes).

Card 4	1	2	3	4	5	6	7	8
Variable	DIP	DIPANG	CPLANE	FRPLANE	TPLANE	SHRMAX	LOCAL	
Type	F	F	F	F	F	F	F	
Default	0.0	0.0	0.0	0.0	0.0	1.e20	0.0	

VARIABLE	DESCRIPTION
MID	Material identification. A unique number or label not exceeding 8 characters must be specified.
RO	Mass density
GMOD	Elastic shear modulus
RNU	Poisson's ratio
PHI	Angle of friction (radians)
CVAL	Cohesion value (shear strength at zero normal stress)
PSI	Dilation angle (radians)
NOVOID	Flag = 1 to switch off voiding behavior (see notes)
NPLANES	Number of joint planes (maximum 6)
LCCPDR	Load curve for extra cohesion for parent material (dynamic relaxation)
LCCPT	Load curve for extra cohesion for parent material (transient)
LCCJDR	Load curve for extra cohesion for joints (dynamic relaxation)
LCCJT	Load curve for extra cohesion for joints (transient)
LCSFAC	Load curve giving factor on strength vs. time
GMODDP	Z-coordinate at which GMOD and CVAL are correct
GMODGR	Gradient of GMOD versus z-coordinate (usually negative)

VARIABLE	DESCRIPTION
LCGMEP	Load curve of GMOD versus plastic strain (overrides GMODGR)
LCPHIEP	Load curve of PHI versus plastic strain
LCPSIEP	Load curve of PSI versus plastic strain
LCGMST	(Leave blank)
CVALGR	Gradient of CVAL versus z-coordinate (usually negative)
ANISO	Factor applied to elastic shear stiffness in global XZ and YZ planes
DIP	Angle of the plane in degrees below the horizontal
DIPANG	Plan view angle (degrees) of downhill vector drawn on the plane
CPLANE	Cohesion for shear behavior on plane
PHPLANE	Friction angle for shear behavior on plane (degrees)
TPLANE	Tensile strength across plane (generally zero or very small)
SHRMAX	Max shear stress on plane (upper limit, independent of compression)
LOCAL	EQ.0: DIP and DIPANG are with respect to the global axes EQ.1: DIP and DIPANG are with respect to the local element axes

Remarks:

1. The material has a Mohr Coulomb yield surface, given by $\tau_{\max} = C + \sigma_n \tan(\text{PHI})$, where τ_{\max} = maximum shear stress on any plane, σ_n = normal stress on that plane (positive in compression), C = cohesion, PHI = friction angle. The plastic potential function is of the form $\beta \sigma_k - \sigma_l + \text{constant}$, where σ_k = maximum principal stress, σ_l = minimum principal stress, and $\beta = \frac{1 + \sin(\text{PSI})}{1 - \sin(\text{PSI})}$.
2. The tensile strength of the material is given by $\sigma_{\max} = \frac{C}{\tan(\text{PHI})}$ where C is the cohesion. After the material reaches its tensile strength, further tensile straining leads to volumetric voiding; the voiding is reversible if the strain is reversed.
3. If depth-dependent properties are used, the model must be oriented with the z-axis in the upward direction.

4. Plastic strain is defined as $\sqrt{\frac{2}{3} \varepsilon_{p_{ij}} \varepsilon_{p_{ij}}}$, i.e. the same way as for other elasto-plastic material models.
5. Friction and dilation angles PHI and PSI may vary with plastic strain, to model heavily consolidated materials under large shear strains – as the strain increases, the dilation angle typically reduces to zero and the friction angle to a lower, pre-consolidation value.
6. For similar reasons, the shear modulus may reduce with plastic strain, but this option may sometimes give unstable results.
7. The loadcurves LCCPDR, LCCPT, LCCJDR, LCCJT allow extra cohesion to be specified as a function of time. The cohesion is additional to that specified in the material parameters. This is intended for use during the initial stages of an analysis to allow application of gravity or other loads without cracking or yielding, and for the cracking or yielding then to be introduced in a controlled manner. This is done by specifying extra cohesion that exceeds the expected stresses initially, then declining to zero. If no curves are specified, no extra cohesion is applied.
8. The loadcurve for factor on strength applies simultaneously to the cohesion and $\tan(\text{friction angle})$ of parent material and all joints. This feature is intended for reducing the strength of the material gradually, to explore factors of safety. If no curve is present, a constant factor of 1 is assumed. Values much greater than 1.0 may cause problems with stability.
9. The anisotropic factor ANISO applies the elastic shear stiffness in the global XZ and YZ planes. It can be used only in pure Mohr-Coulomb mode (NPLANES = 0).
10. For friction angle greater than zero, the Mohr Coulomb yield surface implies a tensile pressure limit equal to $CVAL/\tan(\text{PHI})$. The default behaviour is that voids develop in the material when this pressure limit is reached, and the pressure will never become more tensile than the pressure limit. If NOVOID = 1, the tensile pressure limit is not applied. Stress states in which the pressure is more tensile than $CVAL/\tan(\text{PHI})$ are permitted, but will be purely hydrostatic with no shear stress. NOVOID is recommended in Multi-Material ALE simulations, in which the development of voids or air space is already accounted for by the Multi-Material ALE.
11. To model soil, set NJOINT = 0. The joints are to allow modeling of rock, and are treated identically to those of *MAT_JOINTED_ROCK.
12. The joint plane orientations are defined by the angle of a “downhill vector” drawn on the plane, i.e. the vector is oriented within the plane to obtain the maximum possible downhill angle. DIP is the angle of this line below the horizontal. DIPANG is the plan-view angle of the line (pointing down hill) measured clockwise from the global Y-axis about the global Z-axis.
13. Joint planes would generally be defined in the global axis system if they are taken from survey data. However, the material model can also be used to represent ma-

sonry, in which case the weak planes represent the cement and lie parallel to the local element axes.

14. The joint planes rotate with the rigid body motion of the elements, irrespective of whether their initial definitions are in the global or local axis system.
15. Extra variables for plotting. By setting NEIPH on *DATABASE_EXTENT_BINARY to 27, the following variables can be plotted in Oasys Ltd. Post Processors D3-PLOT, T/HIS and LS-PrePost:

<u>Variable(s)</u>	<u>Description</u>
1	mobilized strength fraction for base material
2	volumetric void strain
3	maximum stress overshoot during plastic calculation
4 - 9	crack opening strain for planes 1 - 6
10 - 15	crack accumulated shear strain for planes 1 - 6
16 - 20	current shear utilization for planes 1 - 6
21 - 27	maximum shear utilization to date for planes 1 - 6
33	elastic shear modulus (for checking depth-dependent input)
34	cohesion (for checking depth-dependent input)

***MAT_RC_BEAM**

This is Material Type 174, for Hughes-Liu beam elements only. The material model can represent plain concrete only, reinforcing steel only, or a smeared combination of concrete and reinforcement. The main emphasis of this material model is the cyclic behavior – it is intended primarily for seismic analysis.

Card 1	1	2	3	4	5	6	7	8
Variable	MID	RO	EUNL	PR	FC	EC1	EC50	RESID
Type	A8	F	F	F	F	F	F	F
Default	none	none	See Remarks	0.0	none	0.0022	See Remarks	0.2

Card 2	1	2	3	4	5	6	7	8
Variable	FT	UNITC	(blank)	(blank)	(blank)	ESOFT	LCHAR	OUTPUT
Type	F	F	F	F	F	F	F	F
Default	See Remarks	1.0	none	none	none	See Remarks	none	0

Card 3	1	2	3	4	5	6	7	8
Variable	FRACR	YMREIN	PRREIN	SYREIN	SUREIN	ESHR	EUR	RREINF
Type	F	F	F	F	F	F	F	F
Default	0.0	none	0.0	0.0	SYREIN	0.03	0.2	4.0

VARIABLE**DESCRIPTION**

MID

Material identification. A unique number or label not exceeding 8 characters must be specified.

VARIABLE	DESCRIPTION
RO	Mass density
EUNL	Initial unloading elastic modulus (See Remarks).
PR	Poisson's ratio.
FC	Cylinder strength (stress units)
EC1	Strain at which stress FC is reached.
EC50	Strain at which the stress has dropped to 50% FC
RESID	Residual strength factor
FT	Maximum tensile stress
UNITC	Factor to convert stress units to MPa (See Remarks)
ESOFT	Slope of stress-strain curve post-cracking in tension
LCHAR	Characteristic length for strain-softening behavior
OUTPUT	Output flag controlling what is written as "plastic strain" EQ.0.0: Curvature EQ.1.0: "High-tide" plastic strain in reinforcement
FRACR	Fraction of reinforcement (e.g. for 1% reinforcement FRACR = 0.01)
YMREIN	Young's Modulus of reinforcement
PRREIN	Poisson's Ratio of reinforcement
SYREIN	Yield stress of reinforcement
SUREIN	Ultimate stress of reinforcement
ESHR	Strain at which reinforcement begins to harden
EUR	Strain at which reinforcement reaches ultimate stress
R_REINF	Dimensionless Ramberg-Osgood parameter r. If zero, a default value r = 4.0 will be used. If set to -1, parameters will be calculated from Kent & Park formulae. (See Remarks)

Creating sections for reinforced concrete beams:

This material model can be used to represent unreinforced concrete (FRACR = 0), steel (FRACR = 1), or reinforced concrete with evenly distributed reinforcement ($0 < \text{FRACR} < 1$).

Alternatively, use *INTEGRATION_BEAM to define the section. A new option in allows the user to define a Part ID for each integration point, similar to the facility already available with *INTEGRATION_SHELL. All parts referred to by one integration rule must have the same material type, but can have different material properties. Create one Part for concrete, and another for steel. These Parts should reference Materials, both of type *MAT_RC_BEAM, one with FRACR = 0, the other with FRACR = 1. Then, by assigning one or other of these Part Ids to each integration point the reinforcement can be applied to the correct locations within the section of the beam.

Concrete:

In monotonic compression, the approach of Park and Kent, as described in Park & Paulay [1975] is used. The material follows a parabolic stress-strain curve up to a maximum stress equal to the cylinder strength FC ; thereafter the strength decays linearly with strain until the residual strength is reached. Default values for some material parameters will be calculated automatically as follows:

$$EC50 = \frac{(3 + 0.29FC)}{145FC - 1000}$$

where FC is in MPa as per Park and Kent test data.

$$EUNL = \text{initial tangent slope} = \frac{2FC}{EC1}$$

User-defined values for $EUNL$ lower than this are not permitted, but higher values may be defined if desired.

$$FT = 1.4 \left(\frac{FC}{10} \right)^{\frac{2}{3}}$$

where FC is in MPa as per Park and Kent test data.

$$ESOFT = EUNL$$

User-defined values higher than $EUNL$ are not permitted.

UNITC is used only to calculate default values for the above parameters from FC .

Strain-softening behavior tends to lead to deformations being concentrated in one element, and hence the overall force-deflection behavior of the structure can be mesh-size-dependent if the softening is characterized by strain. To avoid this, a characteristic length (LCHAR) may be defined. This is the length of specimen (or element) that would exhibit the defined monotonic stress-strain relationship. LS-DYNA adjusts the stress-strain rela-

tionship after ultimate load for each element, such that all elements irrespective of their length will show the same deflection during strain softening (i.e. between ultimate load and residual load). Therefore, although deformation will still be concentrated in one element, the load-deflection behavior should be the same irrespective of element size. For tensile behavior, ESOFT is similarly scaled.

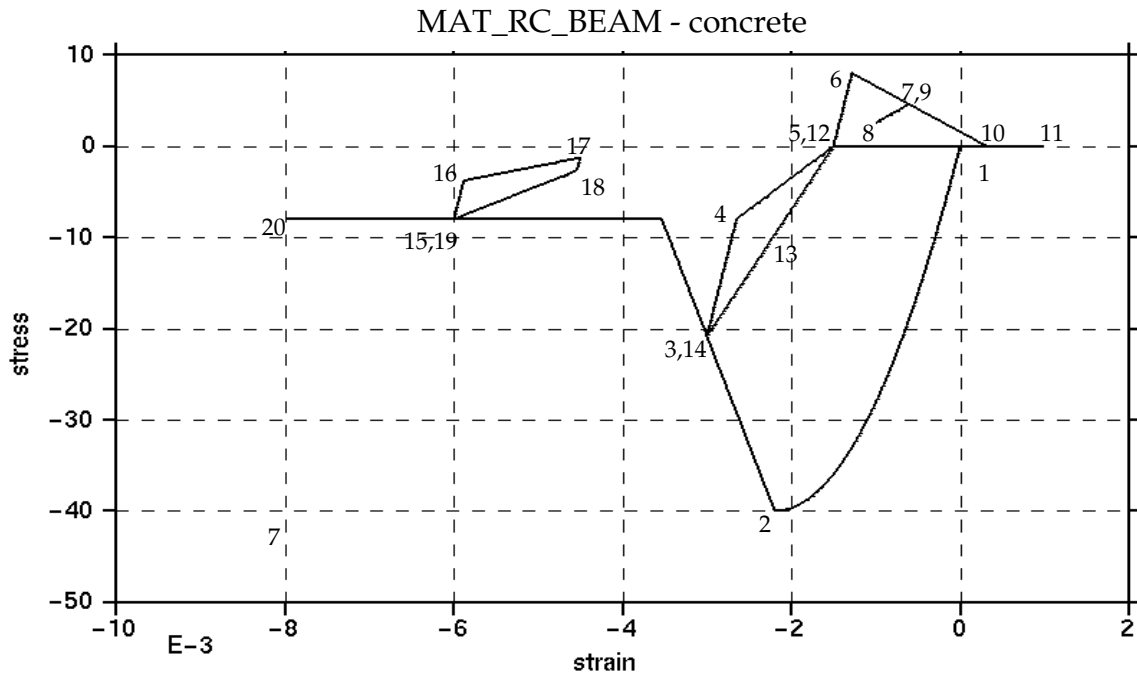

Figure 2-97

Cyclic behavior is broadly suggested by Blakeley and Park [1973] as described in Park & Paulay [1975]; the stress-strain response lies within the Park-Kent envelope, and is characterized by stiff initial unloading response at slope EUNL followed by a less stiff response if it unloads to less than half the current strength. Reloading stiffness degrades with increasing strain.

In tension, the stress rises linearly with strain until a tensile limit F_T is reached. Thereafter the stiffness and strength decays with increasing strain at a rate ESOFT. The stiffness also decays such that unloading always returns to strain at which the stress most recently changed to tensile.

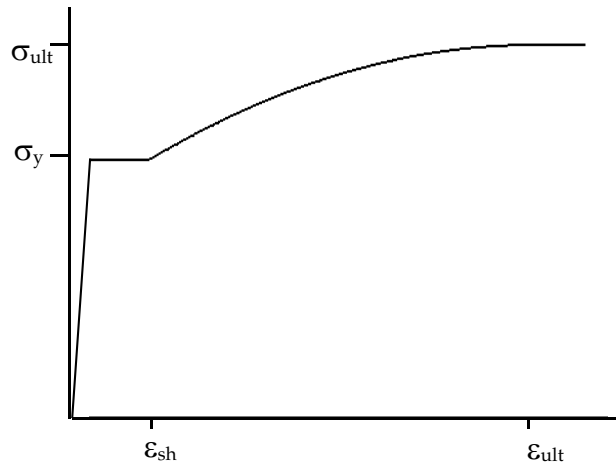

Figure 2-98

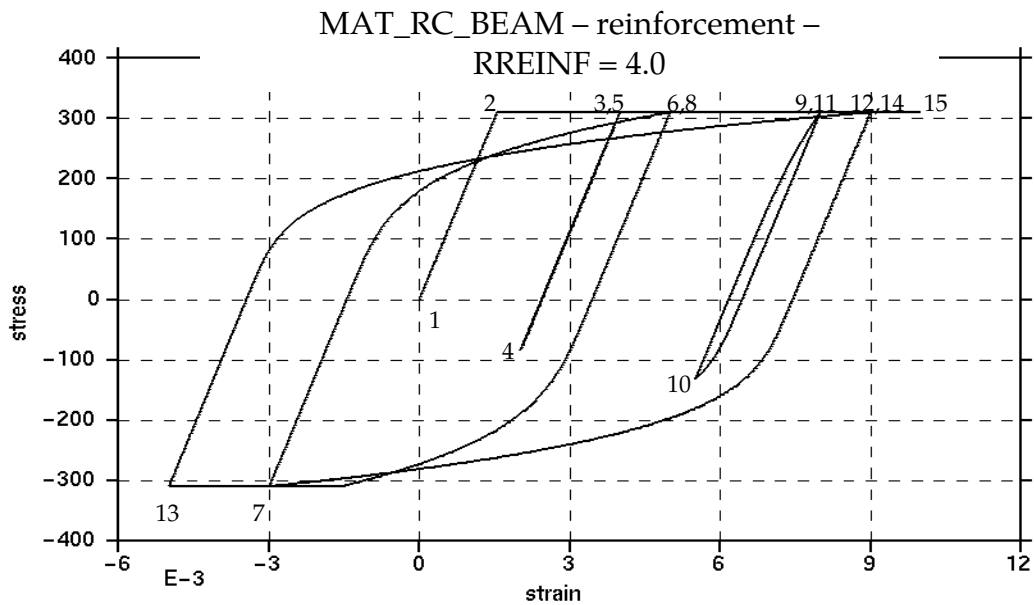

Figure 2-99

Monotonic loading of the reinforcement results in the stress-strain curve shown, which is parabolic between ϵ_{sh} and ϵ_{ult} . The same curve acts as an envelope on the hysteretic behavior, when the x-axis is cumulative plastic strain.

Unloading from the yielded condition is elastic until the load reverses. Thereafter, the Bauschinger Effect (reduction in stiffness at stresses less than yield during cyclic deformation) is represented by following a Ramberg-Osgood relationship until the yield stress is reached:

$$\epsilon - \epsilon_s = \left(\frac{\sigma}{E}\right) \left\{ 1 + \left(\frac{\sigma}{\sigma_{CH}}\right)^{r-1} \right\}$$

where ε and σ are strain and stress, ε_s is the strain at zero stress, E is Young's Modulus, and r and σ_{CH} are as defined below

Two options are given for calculation r and σ_{CH} , which is performed at each stress reversal:

1. If RREINF is input as -1, r and σ_{CH} are calculated internally from formulae given in Kent and Park. Parameter r depends on the number of stress reversals. Parameter σ_{CH} depends on the plastic strain that occurred between the previous two stress reversals. The formulae were statistically derived from experiments, but may not fit all circumstances. In particular, large differences in behavior may be caused by the presence or absence of small stress reversals such as could be caused by high frequency oscillations. Therefore, results might sometimes be unduly sensitive to small changes in the input data.
2. If RREINF is entered by the user or left blank, r is held constant while σ_{CH} is calculated on each reversal such that the Ramberg-Osgood curve meets the monotonic stress-strain curve at the point from which it last unloaded, e.g. points 6 and 8 are coincident in the graph below. The default setting RREINF = 4.0 gives similar hysteresis behavior to that described by Kent & Park but is unlikely to be so sensitive to small changes of input data.

Output:

It is recommended to use BEAMIP on *DATABASE_EXTENT_BINARY to request stress and strain output at the individual integration points. If this is done, for MAT_RC_BEAM only, element curvature is written to the output files in place of plastic strain. In the post-processor, select "plastic strain" to display curvature (whichever of the curvatures about local y and z axes has greatest absolute value will be plotted). Alternatively, select "axial strain" to display the total axial strain (elastic + plastic) at that integration point; this can be combined with axial stress to create hysteresis plots such as those shown above.

***MAT_VISCOELASTIC_THERMAL**

This is Material Type 175. This material model provides a general viscoelastic Maxwell model having up to 12 terms in the prony series expansion and is useful for modeling dense continuum rubbers and solid explosives. Either the coefficients of the prony series expansion or a relaxation curve may be specified to define the viscoelastic deviatoric and bulk behavior. Note that *MAT_GENERAL_VISCOELASTIC (Material Type 76) has all the capability of *MAT_VISCOELASTIC_THERMAL, and additionally offers more terms (18) in the prony series expansion and an optional scaling of material properties with moisture content.

Card 1	1	2	3	4	5	6	7	8
Variable	MID	RO	BULK	PCF	EF	TREF	A	B
Type	A8	F	F	F	F	F	F	F

If fitting is done from a relaxation curve, specify fitting parameters on card 2, *otherwise* if constants are set on Viscoelastic Constant Cards *LEAVE THIS CARD BLANK*.

Card 2	1	2	3	4	5	6	7	8
Variable	LCID	NT	BSTART	TRAMP	LCIDK	NTK	BSTARTK	TRAMPK
Type	F	I	F	F	F	I	F	F

Viscoelastic Constant Cards. Up to 6 cards may be input. A keyword card (with a "*" in column 1) terminates this input if less than 6 cards are used. These cards are not needed if relaxation data is defined. The number of terms for the shear behavior may differ from that for the bulk behavior: simply insert zero if a term is not included. If an elastic layer is defined you only need to define GI and KI (note in an elastic layer only one card is needed).

Optional	1	2	3	4	5	6	7	8
Variable	GI	BETAI	KI	BETAKI				
Type	F	F	F	F				

VARIABLE	DESCRIPTION
MID	Material identification. A unique number or label not exceeding 8 characters must be specified.
RO	Mass density.
BULK	Elastic bulk modulus.
PCF	Tensile pressure elimination flag for solid elements only. If set to unity tensile pressures are set to zero.
EF	Elastic flag (if equal 1, the layer is elastic. If 0 the layer is viscoelastic).
TREF	Reference temperature for shift function (must be greater than zero).
A	Coefficient for the Arrhenius and the Williams-Landau-Ferry shift functions.
B	Coefficient for the Williams-Landau-Ferry shift function.
LCID	Load curve ID for deviatoric behavior if constants, G_i , and β_i are determined via a least squares fit. This relaxation curve is shown below.
NT	Number of terms in shear fit. If zero the default is 6. Fewer than NT terms will be used if the fit produces one or more negative shear moduli. Currently, the maximum number is set to 6.
BSTART	In the fit, β_1 is set to zero, β_2 is set to BSTART, β_3 is 10 times β_2 , β_4 is 10 times β_3 , and so on. If zero, BSTART is determined by an iterative trial and error scheme.
TRAMP	Optional ramp time for loading.
LCIDK	Load curve ID for bulk behavior if constants, K_i , and β_{κ_i} are determined via a least squares fit. This relaxation curve is shown below.
NTK	Number of terms desired in bulk fit. If zero the default is 6. Currently, the maximum number is set to 6.
BSTARTK	In the fit, β_{κ_1} is set to zero, β_{κ_2} is set to BSTARTK, β_{κ_3} is 10 times β_{κ_2} , β_{κ_4} is 10 times β_{κ_3} , and so on. If zero, BSTARTK is determined by an iterative trial and error scheme.
TRAMPK	Optional ramp time for bulk loading.

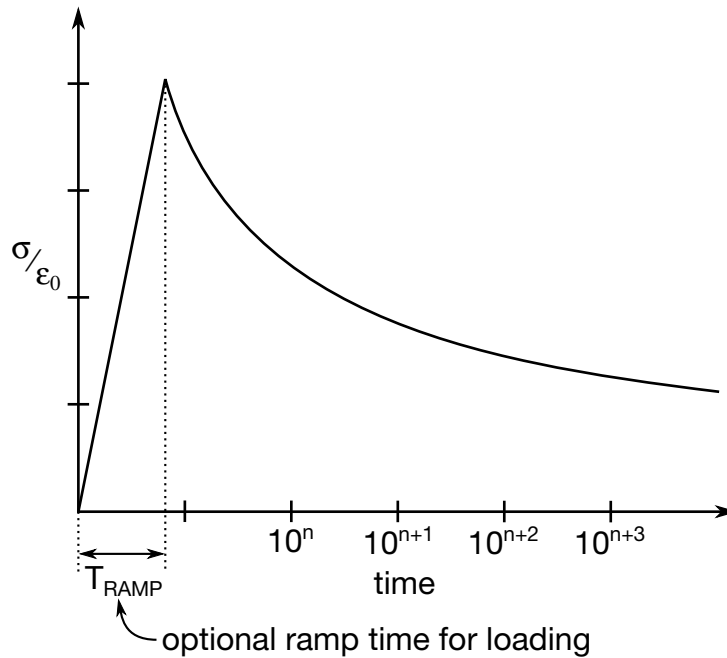

Figure 2-100. Relaxation curve. This curve defines stress versus time where time is defined on a logarithmic scale. For best results, the points defined in the load curve should be equally spaced on the logarithmic scale. Furthermore, the load curve should be smooth and defined in the positive quadrant. If nonphysical values are determined by least squares fit, LS-DYNA will terminate with an error message after the initialization phase is completed. If the ramp time for loading is included, then the relaxation which occurs during the loading phase is taken into account. This effect may or may not be important

VARIABLE	DESCRIPTION
GI	Optional shear relaxation modulus for the ith term
BETAI	Optional shear decay constant for the ith term
KI	Optional bulk relaxation modulus for the ith term
BETAKI	Optional bulk decay constant for the ith term

Remarks:

Rate effects are taken into account through linear viscoelasticity by a convolution integral of the form:

$$\sigma_{ij} = \int_0^t g_{ijkl}(t - \tau) \frac{\partial \epsilon_{kl}}{\partial \tau} d\tau$$

where $g_{ijkl}(t-\tau)$ is the relaxation functions for the different stress measures. This stress is added to the stress tensor determined from the strain energy functional.

If we wish to include only simple rate effects, the relaxation function is represented by six terms from the Prony series:

$$g(t) = \sum_{m=1}^N G_m e^{-\beta_m t}$$

We characterize this in the input by shear moduli, G_i , and decay constants, β_i . An arbitrary number of terms, up to 6, may be used when applying the viscoelastic model.

For volumetric relaxation, the relaxation function is also represented by the Prony series in terms of bulk moduli:

$$k(t) = \sum_{m=1}^N K_m e^{-\beta_{k_m} t}$$

The Arrhenius and Williams-Landau-Ferry (WLF) shift functions account for the effects of the temperature on the stress relaxation. A scaled time, t' ,

$$t' = \int_0^t \Phi(T) dt$$

is used in the relaxation function instead of the physical time. The Arrhenius shift function is

$$\Phi(T) = \exp \left[-A \left(\frac{1}{T} - \frac{1}{T_{\text{REF}}} \right) \right]$$

and the Williams-Landau-Ferry shift function is

$$\Phi(T) = \exp \left(-A \frac{T - T_{\text{REF}}}{B + T - T_{\text{REF}}} \right)$$

If all three values (T_{REF} , A , and B) are not zero, the WLF function is used; the Arrhenius function is used if B is zero; and no scaling is applied if all three values are zero.

***MAT_QUASILINEAR_VISCOELASTIC**

Purpose: This is Material Type 176. This is a quasi-linear, isotropic, viscoelastic material based on a one-dimensional model by Fung [1993], which represents biological soft tissues such as brain, skin, kidney, spleen, etc. This model is implemented for solid and shell elements. The formulation has recently been changed to allow larger strains, and, in general, will not give the same results as the previous implementation which remains the default.

Card 1	1	2	3	4	5	6	7	8
Variable	MID	RO	K	LC1	LC2	N	GSTART	M
Type	A8	F	F	I	I	F	F	F
Default	none	none	none	0	0	6	1/TMAX X	6

Card 2	1	2	3	4	5	6	7	8
Variable	S0	E_MIN	E_MAX	GAMA1	GAMA2	K	EH	FORM
Type	F	F	F	F	F	F	F	I
Default	0.0	-0.9	5.1	0.0	0.0	0.0	0.0	0

Viscoelastic Constant Card 1. Additional Card for LC1 = 0.

Card 3	1	2	3	4	5	6	7	8
Variable	G1	BETA1	G2	BETA2	G3	BETA3	G4	BETA4
Type	F	F	F	F	F	F	F	F

Viscoelastic Constant Card 2. Additional Card for LC1 = 0.

Card 4	1	2	3	4	5	6	7	8
Variable	G5	BETA5	G6	BETA6	G7	BETA7	G8	BETA8
Type	F	F	F	F	F	F	F	F

Viscoelastic Constant Card 2. Additional Card for LC1 = 0.

Card 5	1	2	3	4	5	6	7	8
Variable	G9	BETA9	G10	BETA10	G11	BETA11	G12	BETA12
Type	F	F	F	F	F	F	F	F

Instantaneous Elastic Reponses Card. Additional Card for LC2 = 0.

Card	1	2	3	4	5	6	7	8
Variable	C1	C2	C3	C4	C5	C6		
Type	F	F	F	F	F	F		

VARIABLE**DESCRIPTION**

MID	Material identification. A unique number or label not exceeding 8 characters must be specified.
RO	Mass density.
K	Bulk modulus.
LC1	Load curve ID that defines the relaxation function in shear. This curve is used to fit the coefficients G_i and $BETA_i$. If zero, define the coefficients directly. The latter is recommended.

VARIABLE	DESCRIPTION
LC2	Load curve ID that defines the instantaneous elastic response in compression and tension. If zero, define the coefficients directly. <i>Symmetry is not assumed if only the tension side is define; therefore, defining the response in tension only, may lead to nonphysical behavior in compression. Also, this curve should give a softening response for increasing strain without any negative or zero slopes. A stiffening curve or one with negative slopes is generally unstable.</i>
N	Number of terms used in the Prony series, a number less than or equal to 6. This number should be equal to the number of decades of time covered by the experimental data. Define this number if LC1 is nonzero. Carefully check the fit in the D3HSP file to ensure that it is valid, since the least square fit is not always reliable.
GSTART	Starting value for least square fit. If zero, a default value is set equal to the inverse of the largest time in the experiment. Define this number if LC1 is nonzero.
M	Number of terms used to determine the instantaneous elastic response. This variable is ignored with the new formulation but is kept for compatibility with the previous input.
SO	Strain (logarithmic) output option to control what is written as component 7 to the d3plot database. (LS-PrePost always blindly labels this component as effective plastic strain.) The maximum values are updated for each element each time step: EQ.0.0: maximum principal strain that occurs during the calculation, EQ.1.0: maximum magnitude of the principal strain values that occurs during the calculation, EQ.2.0: maximum effective strain that occurs during the calculation.
E_MIN	Minimum strain used to generate the load curve from Ci. The default range is -0.9 to 5.1. The computed solution will be more accurate if the user specifies the range used to fit the Ci. Linear extrapolation is used outside the specified range.
E_MAX	Maximum strain used to generate the load curve from Ci.

VARIABLE	DESCRIPTION
K	Material failure parameter that controls the volume enclosed by the failure surface, see *MAT_SIMPLIFIED_RUBBER. LE.0.0: ignore failure criterion; GT.0.0: use actual K value for failure criterions.
GAMA1	Material failure parameter, see *MAT_SIMPLIFIED_RUBBER and Figure 2-102 .
GAMA2	Material failure parameter, see *MAT_SIMPLIFIED_RUBBER.
EH	Damage parameter, see *MAT_SIMPLIFIED_RUBBER.
FORM	Formulation of model. FORM = 0 gives the original model developed by Fung, which always relaxes to a zero stress state as time approaches infinity, and FORM = 1 gives the alternative model, which relaxes to the quasi-static elastic response. In general, the two formulations won't give the same responses. Formulation, FORM = -1, is an improvement on FORM = 0 where the instantaneous elastic response is used in the viscoelastic stress update, not just in the relaxation, as in FORM = 0. Consequently, the constants for the elastic response do not need to be scaled.
Gi	Coefficients of the relaxation function. The number of coefficients is currently limited to 6 although 12 may be read in to maintain compatibility with the previous formulation's input. Define these coefficients if LC1 is set to zero. At least 2 coefficients must be nonzero.
BETAi	Decay constants of the relaxation function. Define these coefficients if LC1 is set to zero. The number of coefficients is currently limited to 6 although 12 may be read in to maintain compatibility with the previous formulation's input.
Ci	Coefficients of the instantaneous elastic response in compression and tension. Define these coefficients only if LC2 is set to zero.

Remarks:

The equations for the original model (FORM = 0) are given as:

$$\sigma_V(t) = \int_0^t G(t - \tau) \frac{\partial \sigma_\varepsilon[\varepsilon(\tau)]}{\partial \varepsilon} \frac{\partial \varepsilon}{\partial \tau} d\tau$$

$$G(t) = \sum_{i=1}^n G_i e^{-\beta t}$$
$$\sigma_\varepsilon(\varepsilon) = \sum_{i=1}^k C_i \varepsilon^i$$

where G is the shear modulus. Effective strain (which can be written to the d3plot database) is calculated as follows:

$$\varepsilon^{\text{effective}} = \sqrt{\frac{2}{3} \varepsilon_{ij} \varepsilon_{ij}}$$

The polynomial for instantaneous elastic response should contain only odd terms if symmetric tension-compression response is desired.

The new model (FORM = 1) is based on the hyperelastic model used *MAT_SIMPLIFIED_RUBBER assuming incompressibility. The one-dimensional expression for σ_ε generates the uniaxial stress-strain curve and an additional visco-elastic term is added on,

$$\sigma(\varepsilon, t) = \sigma_{SR}(\varepsilon) + \sigma_V(t)$$
$$\sigma_V(t) = \int_0^t G(t - \tau) \frac{\partial \varepsilon}{\partial \tau} d\tau$$

where the first term to the right of the equals sign is the hyperelastic stress and the second is the viscoelastic stress. Unlike the previous formulation, where the stress always relaxed to zero, the current formulation relaxes to the hyperelastic stress.

*MAT_HILL_FOAM

Purpose: This is Material Type 177. This is a highly compressible foam based on the strain-energy function proposed by Hill [1979]; also see Storakers [1986]. Poisson’s ratio effects are taken into account.

Card 1	1	2	3	4	5	6	7	8
Variable	MID	R0	K	N	MU	LCID	FITTYPE	LCSR
Type	A8	F	F	F	F	I	I	I
Default	none	none	none	0	0	0	0	0

Material Constant Card 1. Additional card for LCID = 0.

Card 2	1	2	3	4	5	6	7	8
Variable	C1	C2	C3	C4	C5	C6	C7	C8
Type	F	F	F	F	F	F	F	F

Material Constant Card 2. Additional card for LCID = 0.

Card 3	1	2	3	4	5	6	7	8
Variable	B1	B2	B3	B4	B5	B6	B7	B8
Type	F	F	F	F	F	F	F	F

Card 4	1	2	3	4	5	6	7	8
Variable	R	M						
Type	F	F						

VARIABLE	DESCRIPTION
MID	Material identification. A unique number or label not exceeding 8 characters must be specified.
RO	Mass density.
K	Bulk modulus. This modulus is used for determining the contact interface stiffness.
N	Material constant. Define if LCID = 0 below; otherwise, N is fit from the load curve data. See equations below.
MU	Damping coefficient.
LCID	Load curve ID that defines the force per unit area versus the stretch ratio. This curve can be given for either uniaxial or biaxial data depending on FITTYPE.
FITTYPE	Type of fit: EQ.1: uniaxial data, EQ.2: biaxial data, EQ.3: pure shear data.
LCSR	Load curve ID that defines the uniaxial or biaxial stretch ratio (see FITTYPE) versus the transverse stretch ratio.
Ci	Material constants. See equations below. Define up to 8 coefficients if LCID = 0.
Bi	Material constants. See equations below. Define up to 8 coefficients if LCID = 0.
R	Mullins effect model r coefficient
M	Mullins effect model m coefficient

Remarks:

If load curve data is defined, the fit generated by LS-DYNA must be closely checked in the D3HSP output file. It may occur that the nonlinear least squares procedure in LS-DYNA, which is used to fit the data, is inadequate.

The Hill strain energy density function for this highly compressible foam is given by:

$$W = \sum_{j=1}^m \frac{C_j}{b_j} \left[\lambda_1^{b_j} + \lambda_2^{b_j} + \lambda_3^{b_j} - 3 + \frac{1}{n} (J^{-nb_j} - 1) \right]$$

where C_j , b_j , and n are material constants and $J = \lambda_1 \lambda_2 \lambda_3$ represents the ratio of the deformed to the undeformed state. The constant m is internally set to 4. In case number of points in the curve is less than 8, then m is set to the number of points divided by 2. The principal Cauchy stresses are

$$t_i = \sum_{j=1}^m \frac{C_j}{J} \left[\lambda_i^{b_j} - J^{-nb_j} \right] \quad i = 1, 2, 3$$

From the above equations the shear modulus is:

$$\mu = \frac{1}{2} \sum_{j=1}^m C_j b_j$$

and the bulk modulus is:

$$K = 2\mu \left(n + \frac{1}{3} \right)$$

The value for K defined in the input is used in the calculation of contact forces and for the material time step. Generally, this value should be equal to or greater than the K given in the above equation.

***MAT_VISCOELASTIC_HILL_FOAM**

Purpose: This is Material Type 178. This is a highly compressible foam based on the strain-energy function proposed by Hill [1979]; also see Storakers [1986]. The extension to include large strain viscoelasticity is due to Feng and Hallquist [2002].

Card 1	1	2	3	4	5	6	7	8
Variable	MID	R0	K	N	MU	LCID	FITTYPE	LCSR
Type	A8	F	F	F	F	I	I	I
Default	none	none	none	0	0	0	0	0

Card 2	1	2	3	4	5	6	7	8
Variable	LCVE	NT	GSTART					
Type	I	F	F					
Default	0	6	1/TMAX					

Material Constant Card 1. Additional card for LCID = 0.

Card 3	1	2	3	4	5	6	7	8
Variable	C1	C2	C3	C4	C5	C6	C7	C8
Type	F	F	F	F	F	F	F	F

Material Constant Card 2. Additional card for LCID = 0.

Card 4	1	2	3	4	5	6	7	8
Variable	B1	B2	B3	B4	B5	B6	B7	B8
Type	F	F	F	F	F	F	F	F

Viscoelastic Constant Cards. Up to 12 cards may be input. A keyword card (with a "*" in column 1) terminates this input if less than 12 cards are used.

Card 5	1	2	3	4	5	6	7	8
Variable	GI	BETAI						
Type	F	F						

VARIABLE	DESCRIPTION
MID	Material identification. A unique number or label not exceeding 8 characters must be specified.
RO	Mass density.
K	Bulk modulus. This modulus is used for determining the contact interface stiffness.
N	Material constant. Define if LCID = 0 below; otherwise, N is fit from the load curve data. See equations below.
MU	Damping coefficient.
LCID	Load curve ID that defines the force per unit area versus the stretch ratio. This curve can be given for either uniaxial or biaxial data depending on FITTYPE. Load curve LCSR below must also be defined.
FITTYPE	Type of fit: EQ.1: uniaxial data, EQ.2: biaxial data.
LCSR	Load curve ID that defines the uniaxial or biaxial stress ratio (see FITTYPE) versus the transverse stretch ratio.
LCVE	Optional load curve ID that defines the relaxation function in shear. This curve is used to fit the coefficients G_i and $BETA_i$. If zero, define the coefficients directly. The latter is recommended.

VARIABLE	DESCRIPTION
NT	Number of terms used to fit the Prony series, which is a number less than or equal to 12. This number should be equal to the number of decades of time covered by the experimental data. Define this number if LCVE is nonzero. Carefully check the fit in the D3HSP file to ensure that it is valid, since the least square fit is not always reliable.
GSTART	Starting value for least square fit. If zero, a default value is set equal to the inverse of the largest time in the experiment. Define this number if LC1 is nonzero, Ci, Material constants. See equations below. Define up to 8 coefficients.
Ci	Material constants. See equations below. Define up to 8 coefficients if LCID = 0.
Bi	Material constants. See equations below. Define up to 8 coefficients if LCID = 0.
GI	Optional shear relaxation modulus for the ith term
BETAI	Optional decay constant if ith term

Remarks:

If load curve data is defined, the fit generated by LS-DYNA must be closely checked in the D3HSP output file. It may occur that the nonlinear least squares procedure in LS-DYNA, which is used to fit the data, is inadequate.

The Hill strain energy density function for this highly compressible foam is given by:

$$p^{n+1} = p^n e^{-\beta \cdot \Delta t} + K \dot{\epsilon}_{kk} \left(\frac{1 - e^{-\beta \cdot \Delta t}}{\beta} \right) \quad \text{where } \beta = |BETA|$$

where C_j , b_j , and n are material constants and $J = \lambda_1 \lambda_2 \lambda_3$ represents the ratio of the deformed to the undeformed state. The principal Cauchy stresses are

$$t_i = \sum_{j=1}^m \frac{C_j}{J} \left[\lambda_i^{b_j} - J^{-n b_j} \right] \quad i = 1, 2, 3$$

From the above equations the shear modulus is:

$$\mu = \frac{1}{2} \sum_{j=1}^m C_j b_j$$

and the bulk modulus is:

$$K = 2\mu \left(n + \frac{1}{3} \right)$$

The value for K defined in the input is used in the calculation of contact forces and for the material time step. Generally, this value should be equal to or greater than the K given in the above equation.

Rate effects are taken into account through linear viscoelasticity by a convolution integral of the form:

$$\sigma_{ij} = \int_0^t g_{ijkl}(t - \tau) \frac{\partial \varepsilon_{kl}}{\partial \tau} d\tau$$

or in terms of the second Piola-Kirchhoff stress, S_{ij} , and Green's strain tensor, E_{ij} ,

$$S_{ij} = \int_0^t G_{ijkl}(t - \tau) \frac{\partial E_{kl}}{\partial \tau} d\tau$$

where $g_{ijkl}(t - \tau)$ and $G_{ijkl}(t - \tau)$ are the relaxation functions for the different stress measures. This stress is added to the stress tensor determined from the strain energy functional.

If we wish to include only simple rate effects, the relaxation function is represented by six terms from the Prony series:

$$g(t) = \alpha_0 + \sum_{m=1}^N \alpha_m e^{-\beta t}$$

given by,

$$g(t) = \sum_{i=1}^n G_i e^{-\beta_i t}$$

This model is effectively a Maxwell fluid which consists of a dampers and springs in series. We characterize this in the input by shear moduli, G_i , and decay constants, β_i . The viscoelastic behavior is optional and an arbitrary number of terms may be used.

***MAT_LOW_DENSITY_SYNTHETIC_FOAM_{OPTION}**

This is Material Type 179 (and 180 if the ORTHO option below is active) for modeling rate independent low density foams, which have the property that the hysteresis in the loading-unloading curve is considerably reduced after the first loading cycle. In this material we assume that the loading-unloading curve is identical after the first cycle of loading is completed and that the damage is isotropic, i.e., the behavior after the first cycle of loading in the orthogonal directions also follows the second curve. The main application at this time is to model the observed behavior in the compressible synthetic foams that are used in some bumper designs. Tables may be used in place of load curves to account for strain rate effects.

Available options include:

<BLANK>

ORTHO

WITH_FAILURE

ORTHO_WITH_FAILURE

If the foam develops orthotropic behavior, i.e., after the first loading and unloading cycle the material in the orthogonal directions are unaffected then the ORTHO option should be used. If the ORTHO option is active the directionality of the loading is stored. This option is requires additional storage to store the history variables related to the orthogonality and is slightly more expensive.

An optional failure criterion is included. A description of the failure model is provided below for material type 181, *MAT_SIMPLIFIED_RUBBER/FOAM.

Card 1	1	2	3	4	5	6	7	8
Variable	MID	R0	E	LCID1	LCID2	HU	BETA	DAMP
Type	A8	F	F	F	F	F	F	F
Default						1.		0.05

Card 2	1	2	3	4	5	6	7	8
Variable	SHAPE	FAIL	BVFLAG	ED	BETA1	KCON	REF	TC
Type	F	F	F	F	F	F	F	F
Default	1.0	0.0	0.0	0.0	0.0	0.0	0.0	1.E+20

Additional card for LCID1 < 0.

Card 3	1	2	3	4	5	6	7	8
Variable	RFLAG	DTRT						
Type	F	F						
Default	0.0	0.0						

Additional card for WITH_FAILURE keyword option.

Card 4	1	2	3	4	5	6	7	8
Variable	K	GAMA1	GAMA2	EH				
Type	F	F	F	F				

VARIABLE**DESCRIPTION**

MID	Material identification. A unique number or label not exceeding 8 characters must be specified.
RO	Mass density
E	Young's modulus. This modulus is used if the elongations are tensile as described for the *MAT_LOW_DENSITY_FOAM.

VARIABLE	DESCRIPTION
LCID1	<p>Load curve or table ID:</p> <p>GT.0: Load curve ID, see *DEFINE_CURVE, for nominal stress versus strain for the undamaged material.</p> <p>LT.0: -LCID1 is Table ID, see *DEFINE_TABLE, for nominal stress versus strain for the undamaged material as a function of strain rate</p>
LCID2	<p>Load curve or table ID. The load curve ID, see *DEFINE_CURVE, defines the nominal stress versus strain for the damaged material. The table ID, see *DEFINE_TABLE, defines the nominal stress versus strain for the damaged material as a function of strain rate</p>
HU	<p>Hysteretic unloading factor between 0 and 1 (default = 1, i.e., no energy dissipation), see also Figure 2-101.</p>
BETA	<p>β, decay constant to model creep in unloading</p>
DAMP	<p>Viscous coefficient (.05 < recommended value < .50) to model damping effects.</p> <p>LT.0.0: DAMP is the load curve ID, which defines the damping constant as a function of the maximum strain in compression defined as:</p> $\varepsilon_{\max} = \max(1 - \lambda_1, 1 - \lambda_2, 1 - \lambda_3).$ <p>In tension, the damping constant is set to the value corresponding to the strain at 0. The abscissa should be defined from 0 to 1.</p>
SHAPE	<p>Shape factor for unloading. Active for nonzero values of the hysteretic unloading factor. Values less than one reduces the energy dissipation and greater than one increases dissipation, see also Figure 2-101</p>
FAIL	<p>Failure option after cutoff stress is reached:</p> <p>EQ.0.0: tensile stress remains at cut-off value,</p> <p>EQ.1.0: tensile stress is reset to zero.</p>
BVFLAG	<p>Bulk viscosity activation flag, see remark below:</p> <p>EQ.0.0: no bulk viscosity (recommended),</p> <p>EQ.1.0: bulk viscosity active.</p>

VARIABLE	DESCRIPTION
ED	Optional Young's relaxation modulus, E_d , for rate effects. See comments below.
BETA1	Optional decay constant, β_1 .
KCON	Stiffness coefficient for contact interface stiffness. If undefined the maximum slope in stress vs. strain curve is used. When the maximum slope is taken for the contact, the time step size for this material is reduced for stability. In some cases Δt may be significantly smaller, and defining a reasonable stiffness is recommended.
REF	Use reference geometry to initialize the stress tensor. The reference geometry is defined by the keyword:*INITIAL_FOAM_REFERENCE_GEOMETRY (see there for more details). EQ.0.0: off, EQ.1.0: on.
TC	Tension cut-off stress
RFLAG	Rate type for input: EQ.0.0: LCID1 and LCID2 should be input as functions of true strain rate EQ.1.0: LCID1 and LCID2 should be input as functions of engineering strain rate.
DTRT	Strain rate averaging flag: EQ.0.0: use weighted running average LT.0.0: average the last 11 values GT.0.0: average over the last DTRT time units.
K	Material failure parameter that controls the volume enclosed by the failure surface. LE.0.0: ignore failure criterion; GT.0.0: use actual K value for failure criterions.
GAMA1	Material failure parameter, see equations below and Figure 2-102 .
GAMA2	Material failure parameter, see equations below.
EH	Damage parameter.

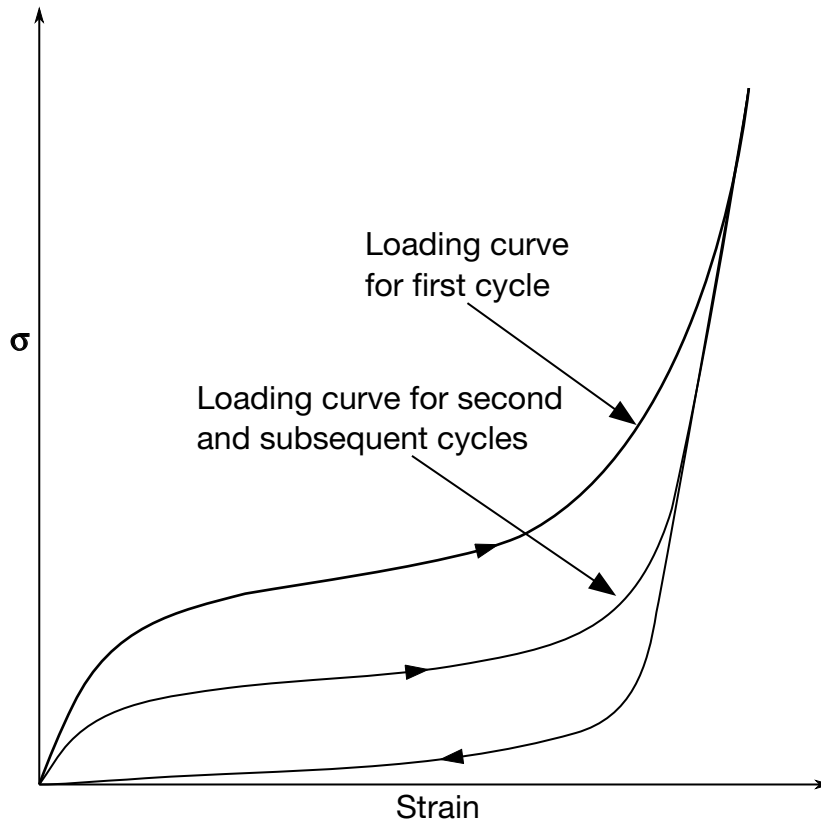

Figure 2-101. Loading and reloading curves.

Remarks:

This model is based on *MAT_LOW_DENSITY_FOAM. The uniaxial response is shown below with a large shape factor and small hysteretic factor. If the shape factor is not used, the unloading will occur on the loading curve for the second and subsequent cycles.

The damage is defined as the ratio of the current volume strain to the maximum volume strain, and it is used to interpolate between the responses defined by LCID1 and LCID2.

HU defines a hysteretic scale factor that is applied to the stress interpolated from LCID1 and LCID2,

$$\sigma = \left[HU + (1 - HU) \times \min \left(1, \frac{e_{int}}{e_{int}^{max}} \right)^S \right] \sigma(LCID1, LCID2)$$

where e_{int} is the internal energy and S is the shape factor. Setting HU to 1 results in a scale factor of 1. Setting HU close to zero scales the stress by the ratio of the internal energy to the maximum internal energy raised to the power S , resulting in the stress being reduced when the strain is low.

***MAT_SIMPLIFIED_RUBBER/FOAM_{OPTION}**

This is Material Type 181. This material model provides a rubber and foam model defined by a single uniaxial load curve or by a family of uniaxial curves at discrete strain rates. The definition of hysteretic unloading is optional and can be realized via a single uniaxial unloading curve or a two-parameter formulation (starting with 971 release R5). The foam formulation is triggered by defining a Poisson’s ratio. This material may be used with both shell and solid elements.

Available options include:

<BLANK>

WITH_FAILURE

LOG_LOG_INTERPOLATION

When active, a strain based failure surface is defined suitable for incompressible polymers that models failure in both tension and compression.

This material law has been developed at DaimlerChrysler, Sindelfingen, in collaboration with Paul Du Bois, LSTC, and Prof. Dave J. Benson, UCSD.

Card 1	1	2	3	4	5	6	7	8
Variable	MID	RO	KM	MU	G	SIGF	REF	PRTEN
Type	A8	F	F	F	F	F	F	F

Card 2	1	2	3	4	5	6	7	8
Variable	SGL	SW	ST	LC /TBID	TENSION	RTYPE	AVGOPT	PR/BETA
Type	F	F	F	F	F	F	F	F

Additional card for WITH_FAILURE keyword option.

Card 3	1	2	3	4	5	6	7	8
Variable	K	GAMA1	GAMA2	EH				
Type	F	F	F	F				

Card 4	1	2	3	4	5	6	7	8
Variable	LCUNLD	HU	SHAPE	STOL				
Type	F	F	F	F				

VARIABLE**DESCRIPTION**

MID	Material identification. A unique number or label not exceeding 8 characters must be specified.
RO	Mass density
KM	Linear bulk modulus.
MU	Damping coefficient.
G	Shear modulus for frequency independent damping. Frequency independent damping is based of a spring and slider in series. The critical stress for the slider mechanism is SIGF defined below. For the best results, the value of G should be 250-1000 times greater than SIGF.
SIGF	Limit stress for frequency independent, frictional, damping.
REF	Use reference geometry to initialize the stress tensor. The reference geometry is defined by the keyword:*INITIAL_FOAM_REFERENCE_GEOMETRY (see there for more details). EQ.0.0: off, EQ.1.0: on.

VARIABLE	DESCRIPTION
PRTEN	The tensile Poisson's ratio for shells (optional). If PRTEN is zero, PR/BETA will serve as the Poisson's ratio for both tension and compression in shells. If PRTEN is nonzero, PR/BETA will serve only as the compressive Poisson's ratio for shells.
SGL	Specimen gauge length
SW	Specimen width
ST	Specimen thickness
LC/TBID	Load curve or table ID, see *DEFINE_TABLE, defining the force versus actual change in the gauge length. If the table definition is used a family of curves are defined for discrete strain rates. The load curves should cover the complete range of expected loading, i.e., the smallest stretch ratio to the largest.
TENSION	Parameter that controls how the rate effects are treated. Applicable to the table definition. EQ.-1.0: rate effects are considered during tension and compression loading, but not during unloading, EQ.0.0: rate effects are considered for compressive loading only, EQ.1.0: rate effects are treated identically in tension and compression.
RTYPE	Strain rate type if a table is defined: EQ.0.0: true strain rate, EQ.1.0: engineering strain rate
AVGOPT	Averaging option determine strain rate to reduce numerical noise. EQ.0.0: simple average of twelve time steps, EQ.1.0: running average of last 12 averages.
PR/BETA	If the value is specified between 0 and 0.5 exclusive, i.e., $0 < PR < 0.50$ the number defined here is taken as Poisson's ratio. If zero, an incompressible rubber like behavior is assumed and a default value of 0.495 is used internally. If a Poisson's ratio of 0.0 is desired, input a small value for PR such as 0.001. When fully integrated solid elements are used and when a nonzero Poisson's ratio is specified, a

VARIABLE	DESCRIPTION
	foam material is assumed and selective-reduced integration is not used due to the compressibility. This is true even if PR approaches 0.500. If any other value excluding zero is define, then BETA is taken as the absolute value of the given number and a nearly incompressible rubber like behavior is assumed. An incrementally updated mean viscous stress develops according to the equation: $p^{n+1} = p^n e^{-\beta \Delta t} + K \dot{\epsilon}_{kk} \left(\frac{1 - e^{-\beta \Delta t}}{\beta} \right), \text{ where } \beta = \text{BETA} $ The BETA parameter does not apply to highly compressible foam materials.
K	Material failure parameter that controls the volume enclosed by the failure surface. LE.0.0: ignore failure criterion; GT.0.0: use actual K value for failure criterions.
GAMA1	Material failure parameter, see equations below and Figure 2-102 .
GAMA2	Material failure parameter, see equations below.
EH	Damage parameter.
LCUNLD	Load curve, see *DEFINE_CURVE, defining the force versus actual length during unloading. The unload curve should cover exactly the same range as LC or the load curves of TBID and its end points should have identical values, i.e., the combination of LC and LCUNLD or the first curve of TBID and LCUNLD describes a complete cycle of loading and unloading. See also material *MAT_083.
HU	Hysteretic unloading factor between 0 and 1 (default = 1., i.e. no energy dissipation), see also material *MAT_083 and Figure 2-31 . This option is ignored if LCUNLD is used.
SHAPE	Shape factor for unloading. Active for nonzero values of the hysteretic unloading factor HU. Values less than one reduces the energy dissipation and greater than one increases dissipation, see also material *MAT_083 and Figure 2-31 .
STOL	Tolerance in stability check, see remarks.

Remarks:

The frequency independent damping is obtained by the having a spring and slider in series as shown in the following sketch:

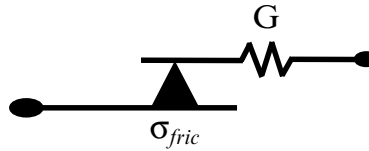

The general failure criterion for polymers is proposed by Feng and Hallquist as

$$f(I_1, I_2, I_3) = (I_1 - 3) + \Gamma_1(I_1 - 3)^2 + \Gamma_2(I_2 - 3) = K$$

where K is a material parameter which controls the size enclosed by the failure surface, and I_1 , I_2 and I_3 are the three invariants of right Cauchy-Green deformation tensor (\mathbf{C})

$$I_1 = C_{ii} = \lambda_1^2 + \lambda_2^2 + \lambda_3^2$$

$$I_2 = \frac{1}{2}(C_{ii}C_{jj} - C_{ij}C_{ij}) = \lambda_1^2 \lambda_2^2 + \lambda_1^2 \lambda_3^2 + \lambda_2^2 \lambda_3^2$$

$$I_3 = \det(\mathbf{C}) = \lambda_1^2 \lambda_2^2 \lambda_3^2$$

with λ_i are the stretch ratios in three principal directions.

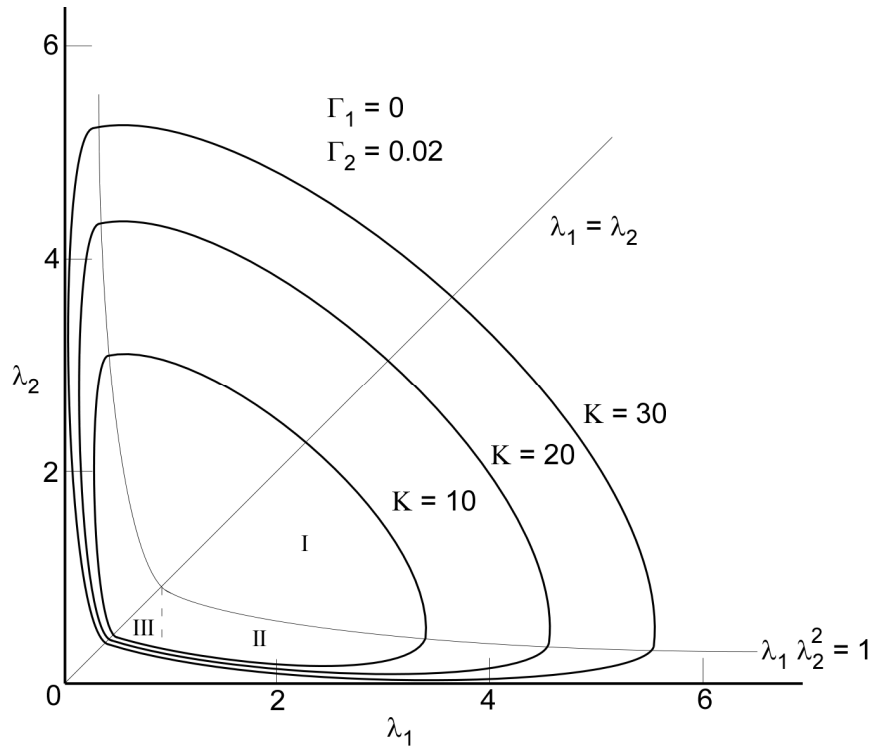

Figure 2-102. Failure surface for polymer.

To avoid sudden failure and numerical difficulty, material failure, which is usually a time point, is modeled as a process of damage growth. In this case, the two threshold values are chosen as $(1 - h)K$ and K , where h (also called EH) is a small number chosen based on experimental results reflecting the range between damage initiation and material failure.

The damage is defined as function of f :

$$D = \begin{cases} 0 & \text{if } f \leq (1 - h)K \\ \frac{1}{2} \left[1 + \cos \frac{\pi(f - K)}{hK} \right] & \text{if } (1 - h)K < f < K \\ 1 & \text{if } f \geq K \end{cases}$$

This definition indicates that damage is first-order continuous. Under this definition, the tangent stiffness matrix will be continuous. The reduced stress considering damage effect is

$$\sigma_{ij} = (1 - D)\sigma_{ij}^o$$

where σ_{ij}^o is the undamaged stress. It is assumed that prior to final failure, material damage is recoverable. Once material failure occurs, damage will become permanent.

The LOG_LOG_INTERPOLATION option interpolates the strain rate effect in the table TBID using log-log interpolation.

Bad choice of curves for the stress-strain response may lead to an unstable model, and there is an option to check this to a certain tolerance level, see dimensionless parameter STOL.

The check is done by examining the eigenvalues of the tangent modulus at selected stretch points and a warning message is issued if an eigenvalue is less than $-\text{STOL} \times \text{BULK}$, where BULK indicates the bulk modulus of the material. For $\text{STOL} < 0$ the check is disabled, otherwise it should be chosen with care, a too small value may detect instabilities that are insignificant in practice. To avoid significant instabilities it is recommended to use smooth curves, at best the curves should be continuously differentiable, in fact for the incompressible case, a sufficient condition for stability is that the stress-stretch curve $S(\lambda)$ can be written as

$$S(\lambda) = H(\lambda) - \frac{H\left(\frac{1}{\sqrt{\lambda}}\right)}{\lambda\sqrt{\lambda}}$$

where $H(\lambda)$ is a function with $H(1) = 0$ and $H'(\lambda) > 0$.

***MAT_SIMPLIFIED_RUBBER_WITH_DAMAGE**

An available options includes:

LOG_LOG_INTERPOLATION

This is Material Type 183. This material model provides an incompressible rubber model defined by a single uniaxial load curve for loading (or a table if rate effects are considered) and a single uniaxial load curve for unloading. This model is similar to *MAT_SIMPLIFIED_RUBBER/FOAM This material may be used with both shell and solid elements.

This material law has been developed at DaimlerChrysler, Sindelfingen, in collaboration with Paul Du Bois, LSTC, and Prof. Dave J. Benson, UCSD.

Card 1	1	2	3	4	5	6	7	8
Variable	MID	RO	K	MU	G	SIGF		
Type	A8	F	F	F	F	F		

Card 2	1	2	3	4	5	6	7	8
Variable	SGL	SW	ST	LC / TBID	TENSION	RTYPE	AVGOPT	
Type	F	F	F	F	F	F	F	

Card 3	1	2	3	4	5	6	7	8
Variable	LCUNLD	REF	STOL					
Type	F	F	F					

VARIABLE**DESCRIPTION**

MID	Material identification. A unique number or label not exceeding 8 characters must be specified.
RO	Mass density
K	Linear bulk modulus.

VARIABLE	DESCRIPTION
MU	Damping coefficient.
G	Shear modulus for frequency independent damping. Frequency independent damping is based of a spring and slider in series. The critical stress for the slider mechanism is SIGF defined below. For the best results, the value of G should be 250-1000 times greater than SIGF.
SIGF	Limit stress for frequency independent, frictional, damping.
SGL	Specimen gauge length
SW	Specimen width
ST	Specimen thickness
LC/TBID	Load curve or table ID, see *DEFINE_TABLE, defining the force versus actual change in the gauge length. If the table definition is used a family of curves are defined for discrete strain rates. The load curves should cover the complete range of expected loading, i.e., the smallest stretch ratio to the largest.
TENSION	Parameter that controls how the rate effects are treated. Applicable to the table definition. EQ.-1.0: rate effects are considered during tension and compression loading, but not during unloading, EQ.0.0: rate effects are considered for compressive loading only, EQ.1.0: rate effects are treated identically in tension and compression.
RTYPE	Strain rate type if a table is defined: EQ.0.0: true strain rate, EQ.1.0: engineering strain rate
AVGOPT	Averaging option determine strain rate to reduce numerical noise. EQ.0.0: simple average of twelve time steps, EQ.1.0: running 12 point average.

VARIABLE	DESCRIPTION
LCUNLD	Load curve, see *DEFINE_CURVE, defining the force versus actual change in the gauge length during unloading. The unload curve should cover exactly the same range as LC (or as the first curve of table TBID) and its end points should have identical values, i.e., the combination of LC (or as the first curve of table TBID) and LCUNLD describes a complete cycle of loading and unloading.
REF	Use reference geometry to initialize the stress tensor. The reference geometry is defined by the keyword:*INITIAL_FOAM_REFERENCE_GEOMETRY (see there for more details). EQ.0.0: off, EQ.1.0: on.
STOL	Tolerance in stability check, see remark 2.

Remarks:

1. The LOG_LOG_INTERPOLATION option interpolates the strain rate effect in the table TBID using log-log interpolation.
2. Bad choice of curves for the stress-strain response may lead to an unstable model, and there is an option to check this to a certain tolerance level, see dimensionless parameter STOL. The check is done by examining the eigenvalues of the tangent modulus at selected stretch points and a warning message is issued if an eigenvalue is less than $-STOL \times BULK$, where BULK indicates the bulk modulus of the material. For $STOL < 0$ the check is disabled, otherwise it should be chosen with care, a too small value may detect instabilities that are insignificant in practice. To avoid significant instabilities it is recommended to use smooth curves, at best the curves should be continuously differentiable, in fact for the incompressible case, a sufficient condition for stability is that the stress-stretch curve $S(\lambda)$ can be written as

$$S(\lambda) = H(\lambda) - \frac{H\left(\frac{1}{\sqrt{\lambda}}\right)}{\lambda\sqrt{\lambda}}$$

where $H(\lambda)$ is a function with $H(1) = 0$ and $H'(\lambda) > 0$.

***MAT_COHESIVE_ELASTIC**

This is Material Type 184. It is a simple cohesive elastic model for use with solid element types 19 and 20, and is not available for other solid element formulation. See the remarks after *SECTION_SOLID for a description of element types 19 and 20.

Card 1	1	2	3	4	5	6	7	8
Variable	MID	RO	ROFLG	INTFAIL	ET	EN	FN_FAIL	
Type	A8	F	F	F	F	F	F	

<u>VARIABLE</u>	<u>DESCRIPTION</u>
MID	Material identification. A unique number or label not exceeding 8 characters must be specified.
RO	Mass density
ROFLG	Flag for whether density is specified per unit area or volume. ROFLG = 0 specified density per unit volume (default), and ROFLG = 1 specifies the density is per unit area for controlling the mass of cohesive elements with an initial volume of zero.
INTFAIL	The number of integration points required for the cohesive element to be deleted. If it is zero, the element won't be deleted even if it satisfies the failure criterion. The value of INTFAIL may range from 1 to 4, with 1 the recommended value.
ET	The stiffness in the plane of the cohesive element.
EN	The stiffness normal to the plane of the cohesive element.
FN_FAIL	The traction in the normal direction for tensile failure.

Remarks:

This material cohesive model outputs three tractions having units of force per unit area into the D3PLOT database rather than the usual six stress components. The in plane shear traction along the 1-2 edge replaces the x-stress, the orthogonal in plane shear traction replaces the y-stress, and the traction in the normal direction replaces the z-stress.

***MAT_COHESIVE_TH**

This is Material Type 185. It is a cohesive model by Tvergaard and Hutchinson [1992] for use with solid element types 19 and 20, and is not available for any other solid element formulation. See the remarks after *SECTION_SOLID for a description of element types 19 and 20. The implementation is based on the description of the implementation in the Sandia National Laboratory code, Tahoe [2003].

Card 1	1	2	3	4	5	6	7	8
Variable	MID	RO	ROFLG	INTFAIL	SIGMAX	NLS	TLS	
Type	A8	F	F	F	F	F	F	

Card 2	1	2	3	4	5	6	7	8
Variable	LAMDA1	LAMDA2	LAMDAF	STFSF				
Type	F	F	F	F				

VARIABLE**DESCRIPTION**

MID	Material identification. A unique number or label not exceeding 8 characters must be specified.
RO	Mass density
ROFLG	Flag for whether density is specified per unit area or volume. ROFLG = 0 specified density per unit volume (default), and ROFLG = 1 specifies the density is per unit area for controlling the mass of cohesive elements with an initial volume of zero.
INTFAIL	The number of integration points required for the cohesive element to be deleted. If it is zero, the element won't be deleted even if it satisfies the failure criterion. The value of INTFAIL may range from 1 to 4, with 1 the recommended value.
SIGMAX	Peak traction.
NLS	Length scale (maximum separation) in the normal direction.
TLS	Length scale (maximum separation) in the tangential direction.

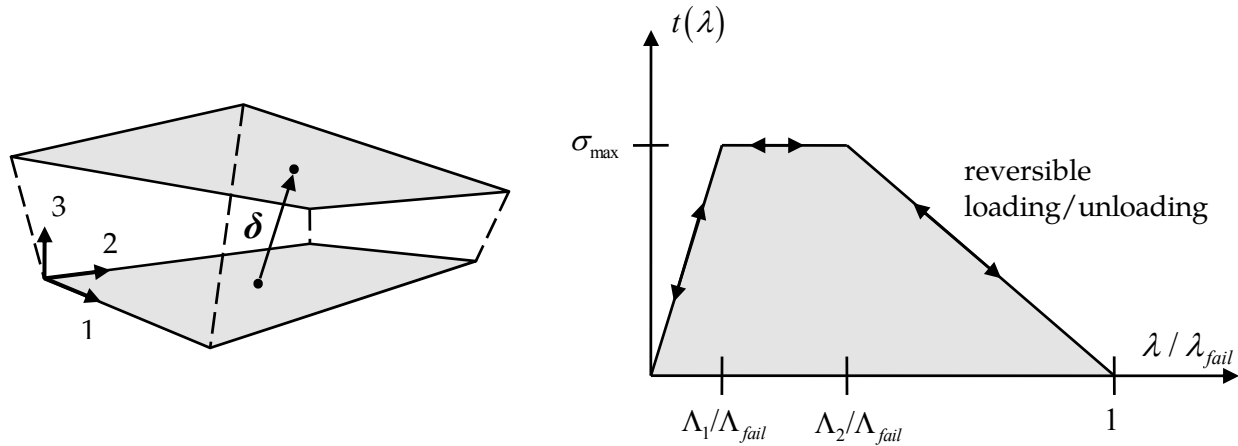

Figure 2-103. Relative displacement and trilinear traction-separation law

VARIABLE	DESCRIPTION
LAMDA1	Scaled distance to peak traction (Λ_1).
LAMDA2	Scaled distance to beginning of softening (Λ_2).
LAMDAAF	Scaled distance for failure (Λ_{fail}).
STFSF	Penetration stiffness multiplier. The penetration stiffness, PS , in terms of input parameters becomes:

$$PS = \frac{STFSF \times SIGMAX}{NLS \times \left(\frac{LAMDA1}{LAMDAAF}\right)}$$

Remarks:

In this cohesive material model, a dimensionless separation measure λ is used, which grasps for the interaction between relative displacements in normal (δ_3 - mode I) and tangential (δ_1, δ_2 - mode II) directions (see [Figure 2-103](#) left):

$$\lambda = \sqrt{\left(\frac{\delta_1}{TLS}\right)^2 + \left(\frac{\delta_2}{TLS}\right)^2 + \left(\frac{\langle\delta_3\rangle}{NLS}\right)^2}$$

where the Mc-Cauley bracket is used to distinguish between tension ($\delta_3 \geq 0$) and compression ($\delta_3 < 0$). NLS and TLS are critical values, representing the maximum separations in the interface in normal and tangential direction. For stress calculation, a trilinear traction-separation law is used, which is given by (see [Figure 2-103](#) right):

$$t(\lambda) = \begin{cases} \sigma_{\max} \frac{\lambda}{\Lambda_1/\Lambda_{\text{fail}}} & \lambda < \Lambda_1/\Lambda_{\text{fail}} \\ \sigma_{\max} & \Lambda_1/\Lambda_{\text{fail}} < \lambda < \Lambda_2/\Lambda_{\text{fail}} \\ \sigma_{\max} \frac{1-\lambda}{1-\Lambda_2/\Lambda_{\text{fail}}} & \Lambda_2/\Lambda_{\text{fail}} < \lambda < 1 \end{cases}$$

With these definitions, the traction drops to zero when $\lambda = 1$. Then, a potential ϕ is defined as:

$$\phi(\delta_1, \delta_2, \delta_3) = \text{NLS} \times \int_0^\lambda t(\bar{\lambda}) d\bar{\lambda}$$

Finally, tangential components (t_1, t_2) and normal component (t_3) of the traction acting on the interface in the fracture process zone are given by:

$$t_{1,2} = \frac{\partial \phi}{\partial \delta_{1,2}} = \frac{t(\lambda)}{\lambda} \frac{\delta_{1,2}}{\text{TLS}} \frac{\text{NLS}}{\text{TLS}}, \quad t_3 = \frac{\partial \phi}{\partial \delta_3} = \frac{t(\lambda)}{\lambda} \frac{\delta_3}{\text{NLS}}$$

which in matrix notation is

$$\begin{bmatrix} t_1 \\ t_2 \\ t_3 \end{bmatrix} = \frac{t(\lambda)}{\lambda} \begin{bmatrix} \frac{\text{NLS}}{\text{TLS}^2} & 0 & 0 \\ 0 & \frac{\text{NLS}}{\text{TLS}^2} & 0 \\ 0 & 0 & \frac{1}{\text{NLS}} \end{bmatrix} \begin{bmatrix} \delta_1 \\ \delta_2 \\ \delta_3 \end{bmatrix}$$

In case of compression ($\delta_3 < 0$), penetration is avoided by:

$$t_3 = \frac{\text{STFSF} \times \sigma_{\max}}{\text{NLS} \times \Lambda_1/\Lambda_{\text{fail}}} \delta_3$$

Loading and unloading follows the same path, i.e. this model is completely reversible.

This cohesive material model outputs three tractions having units of force per unit area into the D3PLOT database rather than the usual six stress components. The in plane shear traction t_1 along the 1-2 edge replaces the x-stress, the orthogonal in plane shear traction t_2 replaces the y-stress, and the traction in the normal direction t_3 replaces the z-stress.

***MAT_COHESIVE_GENERAL**

This is Material Type 186. This model includes three general irreversible mixed-mode interaction cohesive formulations with arbitrary normalized traction-separation law given by a load curve (TSLC). These three formulations are differentiated via the type of effective separation parameter (TES). The interaction between fracture modes I and II is considered, and irreversible conditions are enforced via a damage formulation (unloading/reloading path pointing to/from the origin). See remarks for details.

Card 1	1	2	3	4	5	6	7	8
Variable	MID	RO	ROFLG	INTFAIL	TES	TSLC	GIC	GIIC
Type	A8	F	F	F	F	F	F	F

Card 2	1	2	3	4	5	6	7	8
Variable	XMU	T	S	STFSF				
Type	F	F	F	F				

VARIABLE**DESCRIPTION**

MID	Material identification. A unique number or label not exceeding 8 characters must be specified.
RO	Mass density.
ROFLG	Flag for whether density is specified per unit area or volume. ROFLG = 0 specifies density per unit volume (default), and ROFLG = 1 specifies the density is per unit area for controlling the mass of cohesive elements with an initial volume of zero.
INTFAIL	Number of integration points required for a cohesive element to be deleted. If it is zero, the element won't be deleted even if it satisfies failure criterion. The value of INTFAIL may range from 1 to 4, with 1 the recommended value.

VARIABLE	DESCRIPTION
TES	Type of effective separation parameter (ESP). EQ.0.0 or 1.0: a dimensional separation measure is used. For the interaction between mode I and II, a mixed-mode propagation criterion is used. For TES = 0.0 this is a power-law, and for TES = 1.0 this is the Benzeggagh-Kenane law [1996]. See remarks below. EQ.2.0: a dimensionless separation measure is used, which grasps for the interaction between mode I displacements and mode II displacements (similar to MAT_185, but with damage and general traction-separation law). See remarks below.
TSLC	Normalized traction-separation load curve ID. The curve must be normalized in both coordinates and must contain at least three points: (0.0, 0.0), (λ_0 , 1.0), and (1.0, 0.0), which represents the origin, the peak and the complete failure, respectively (see Figure 2-104). A platform can exist in the curve like the tri-linear TSLC (see MAT_185).
GIC	Fracture toughness / energy release rate G_I^c for mode I
GIIC	Fracture toughness / energy release rate G_{II}^c for mode II
XMU	Exponent that appears in the power failure criterion (TES = 1.0) or the Benzeggagh-Kenane failure criterion (TES = 2.0). Recommended values for XMU are between 1.0 and 2.0.
T	Peak traction in normal direction (mode I)
S	Peak traction in tangential direction (mode II)
STFSF	Penetration stiffness multiplier for compression. Factor = (1.0+STFSF) is used to scale the compressive stiffness, i.e. no scaling is done with STFSF = 0.0 (recommended).

Remarks:

All three formulations have in common, that the traction-separation behavior of this model is mainly given by G_I^c and T for normal mode I, G_{II}^c and S for tangential mode II and an arbitrary normalized traction-separation load curve for both modes (see [Figure 2-104](#)). The maximum (or failure) separations are then given by:

$$\delta_I^F = \frac{G_I^c}{A_{TSLC} \times T} , \quad \delta_{II}^F = \frac{G_{II}^c}{A_{TSLC} \times S}$$

where A_{TSLC} is the area under the normalized traction-separation curve.

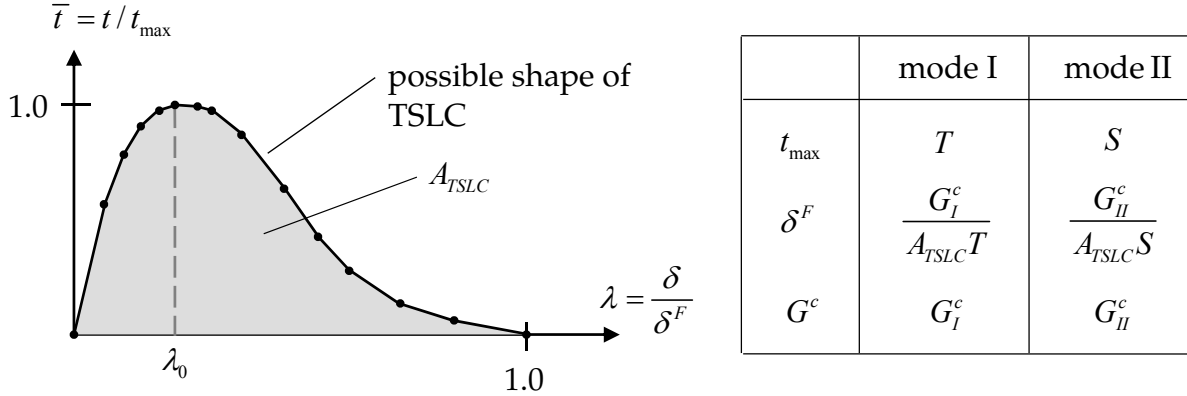

Figure 2-104. Normalized traction-separation law

For mixed-mode behavior, three different formulations are possible (where default TES = 0.0 with XMU = 1.0 is recommended as first guess):

First and second formulation (TES = 0.0 and TES = 1.0):

Here, the total mixed-mode relative displacement δ_m is defined as $\delta_m = \sqrt{\delta_I^2 + \delta_{II}^2}$, where $\delta_I = \delta_3$ is the separation in normal direction (mode I) and $\delta_{II} = \sqrt{\delta_1^2 + \delta_2^2}$ is the separation in tangential direction (mode II) (see Figure 2-105). The ultimate mixed-mode displacement δ^F (total failure) for the power law (TES = 0.0) is:

$$\delta^F = \frac{1 + \beta^2}{A_{TSLC}} \left[\left(\frac{T}{G_I^c} \right)^{XMU} + \left(\frac{S \times \beta^2}{G_{II}^c} \right)^{XMU} \right]^{-\frac{1}{XMU}}$$

and alternatively for the Benzeggagh-Kenane law [1996] (TES = 1.0):

$$\delta^F = \frac{1 + \beta^2}{A_{TSLC}(T + S \times \beta^2)} \left[G_I^c + (G_{II}^c - G_I^c) \left(\frac{S \times \beta^2}{T + S \times \beta^2} \right)^{XMU} \right]$$

where $\beta = \delta_{II}/\delta_I$ is the “mode mixity”. The larger the exponent XMU is chosen, the larger the fracture toughness in mixed-mode situations will be. In this model, damage of the interface is considered, i.e. irreversible conditions are enforced with loading/unloading paths coming from/pointing to the origin. This formulation is similar to MAT_COHESIVE_MIXED_MODE (MAT_138), but with the arbitrary traction-separation law TSLC.

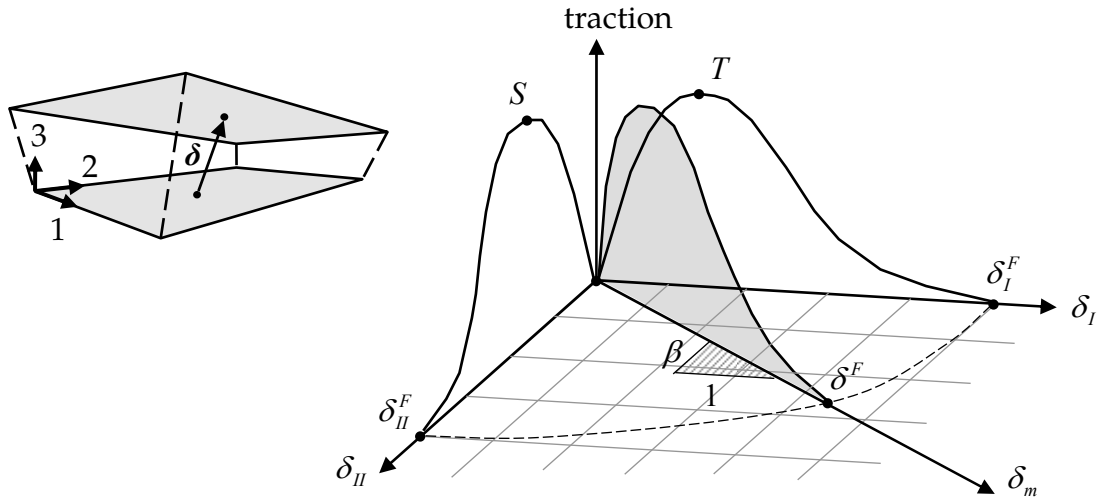

Figure 2-105. Mixed-mode traction-separation law

Third formulation (TES = 2.0):

Here, a dimensionless effective separation parameter λ is used, which grasps for the interaction between relative displacements in normal (δ_3 - mode I) and tangential (δ_1, δ_2 - mode II) directions:

$$\lambda = \sqrt{\left(\frac{\delta_1}{\delta_I^F}\right)^2 + \left(\frac{\delta_2}{\delta_{II}^F}\right)^2 + \left\langle \frac{\delta_3}{\delta_I^F} \right\rangle^2}$$

where the Mc-Cauley bracket is used to distinguish between tension ($\delta_3 \geq 0$) and compression ($\delta_3 < 0$). δ_I^F and δ_{II}^F are critical values, representing the maximum separations in the interface in normal and tangential direction. For stress calculation, the normalized traction-separation load curve TSLC is used: $t = t_{\max} \times \bar{t}(\lambda)$. This formulation is similar to MAT_COHESIVE_TH (MAT_185), but with the arbitrary traction-separation law and a damage formulation (i.e. irreversible conditions are enforced with loading/unloading paths coming from/pointing to the origin).

***MAT_SAMP-1**

Purpose: This is Material Type 187 (Semi-Analytical Model for Polymers). This material model uses an isotropic C-1 smooth yield surface for the description of non-reinforced plastics. Details of the implementation are given in [Kolling, Haufe, Feucht and Du Bois 2005].

This material law has been developed at DaimlerChrysler, Sindelfingen, in collaboration with Paul Du Bois and Dynamore, Stuttgart.

Card 1	1	2	3	4	5	6	7	8
Variable	MID	RO	BULK	GMOD	EMOD	NUE	RBCFAC	NUMINT
Type	A8	F	F	F	F	F	F	

Card 2	1	2	3	4	5	6	7	8
Variable	LCID-T	LCID-C	LCID-S	LCID-B	NUEP	LCID-P		INCDAM
Type	I	I	I	I	F	I		

Card 3	1	2	3	4	5	6	7	8
Variable	LCID-D	EPFAIL	DEPRPT	LCID_TRI	LCID_LC			
Type	I	F	F	I	I			

Card 4	1	2	3	4	5	6	7	8
Variable	MITER	MIPS		INCFail	ICONV	ASAF		
Type	I	I		I	I	F		

VARIABLE**DESCRIPTION**

MID

Material identification. A unique number or label not exceeding 8 characters must be specified.

VARIABLE	DESCRIPTION
RO	Mass density
BULK	Bulk modulus, used by LS-DYNA in the time step calculation
GMOD	Shear modulus, used by LS-DYNA in the time step calculation
EMOD	Young's modulus
NUE	Poisson ratio
RBCFAC	Ratio of yield in biaxial compression vs. yield in uniaxial compression. If nonzero this will activate the use of a multi-linear yield surface. Default is 0.
NUMINT	Number of integration points which must fail before the element is deleted. This option is available for shells and solids. LT.0.0: NUMINT is percentage of integration points/layers which must fail before shell element fails. For fully integrated shells, a methodology is used where a layer fails if one integration point fails and then the given percentage of layers must fail before the element fails. Only available for shells.
LCID-T	Load curve or table ID giving the yield stress as a function of plastic strain, these curves should be obtained from quasi-static and (optionally) dynamic uniaxial tensile tests, this input is mandatory and the material model will not work unless at least one tensile stress-strain curve is given.
LCID-C	Load curve ID giving the yield stress as a function of plastic strain, this curve should be obtained from a quasi-static uniaxial compression test, this input is optional.
LCID-S	Load curve ID giving the yield stress as a function of plastic strain, this curve should be obtained from a quasi-static shear test, this input is optional.
LCID-B	Load curve ID giving the yield stress as a function of plastic strain, this curve should be obtained from a quasi-static biaxial tensile test, this input is optional.
NUEP	Plastic Poisson's ratio: an estimated ratio of transversal to longitudinal plastic rate of deformation under uniaxial loading should be given.

VARIABLE	DESCRIPTION
LCID-P	Load curve ID giving the plastic Poisson's ratio as a function of plastic strain during uniaxial tensile and uniaxial compressive testing. The plastic strain on the abscissa is negative for compression and positive for tension. It is important to cover both tension and compression. If LCID-P is given, the constant value of plastic Poisson's ratio NUPEP is ignored.
INCDAM	Flag to control the damage evolution as a function of triaxiality. EQ.0: damage evolution is independent of the triaxiality. EQ.1: an incremental formulation is used to compute the damage.
LCID-D	Load curve ID giving the damage parameter as a function of equivalent plastic strain during uniaxial tensile testing. By default this option assumes that effective (i.e. undamaged) yield values are used in the load curves LCID-T, LCID-C, LCID-S and LCID-B. If LCID-D is given a negative value, true (i.e. damaged) yield stress values can be used. In this case an automatic stress-strain recalibration (ASSR) algorithm is activated. The damage value must be defined in the range $0 \leq d < 1$. The curve is used only through effective plastic strain = EPFAIL if EPFAIL and DEPRPT are given.
EPFAIL	This parameter is the equivalent plastic strain at failure. If EPFAIL is given as a negative integer, a load curve is expected that defines EPFAIL as a function of the plastic strain rate. Default value is 1.0e+5
DEPRPT	Increment of equivalent plastic strain between failure point and rupture point. Stresses will fade out to zero between EPFAIL and EPFAIL+DEPRPT. If DEPRPT is given a negative value a curve definition is expected where DEPRPT is defined as function of the triaxiality.
LCID_TRI	Load curve that specifies a factor that works multiplicatively on the value of EPFAIL depending on the triaxiality (i.e. pressure/sigma _{vm}). For a triaxiality of -1/3 a value of 1.0 should be specified.
LCID_LC	Load curve that specifies a factor that works multiplicatively on the value of EPFAIL depending on a characteristic element length.
MITER	Maximum number of iterations in the cutting plane algorithm, default is set to 400

VARIABLE	DESCRIPTION
MIPS	Maximum number of iterations in the secant iteration performed to enforce plane stress (shell elements only), default set to 10
INCFAIL	Flag to control the failure evolution as a function of triaxiality. EQ.0: Failure evolution is independent of the triaxiality. EQ.1: Incremental formulation is used to compute the failure value. EQ.-1: the failure model is deactivated.
ICONV	Formulation flag: EQ.0: default EQ.1: yield surface is internally modified by increasing the shear yield until a convex yield surface is achieved.
ASAF	Safety factor, used only if ICONV = 1, values between 1 and 2 can improve convergence, however the shear yield will be artificially increased if this option is used, default is set to 1.

Load curves:

Material SAMP-1 uses three yield curves internally to evaluate a quadratic yield surface. *MAT_SAMP-1 accepts four different kinds of yield curves, LCID_T, LCID_C, LCID_S, and LCID_B where data from tension tests (LCID_T) is always required, but the others are optional. If fewer than three curves are defined, as indicated by setting the missing load curve IDs to 0, the remaining curves are generated internally.

Fewer than 3 load curves:

In the case of fewer than 3 load curves, a linear yield surface in the invariant space spanned by the pressure and the von Mises stress is generated using the available data.

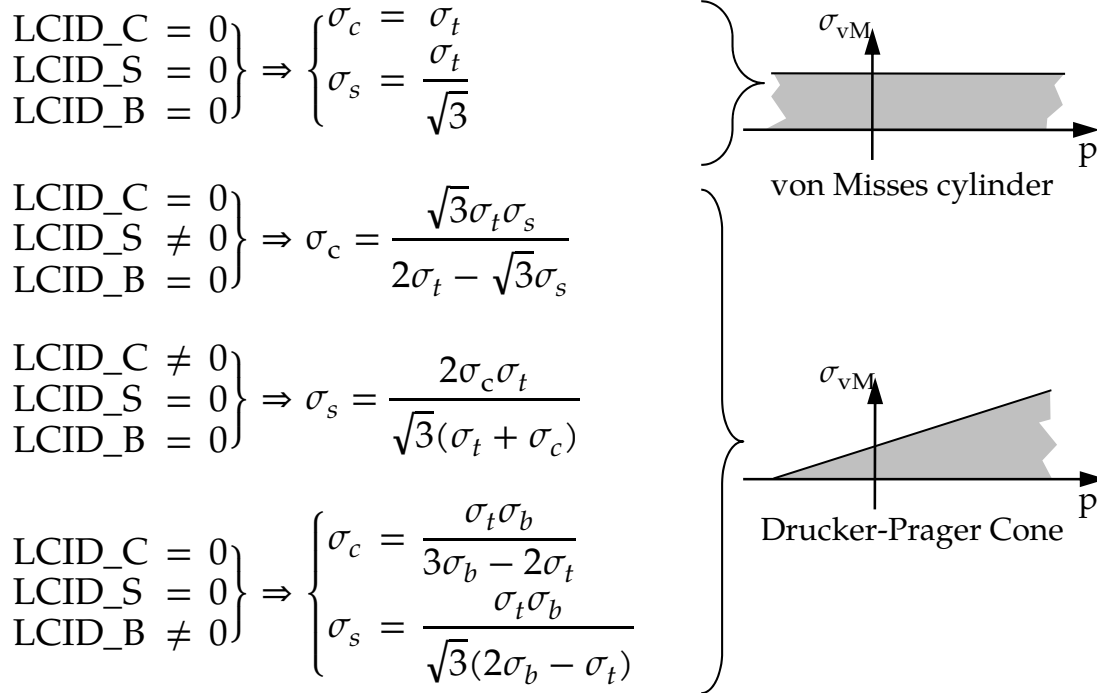

3 or more load curves:

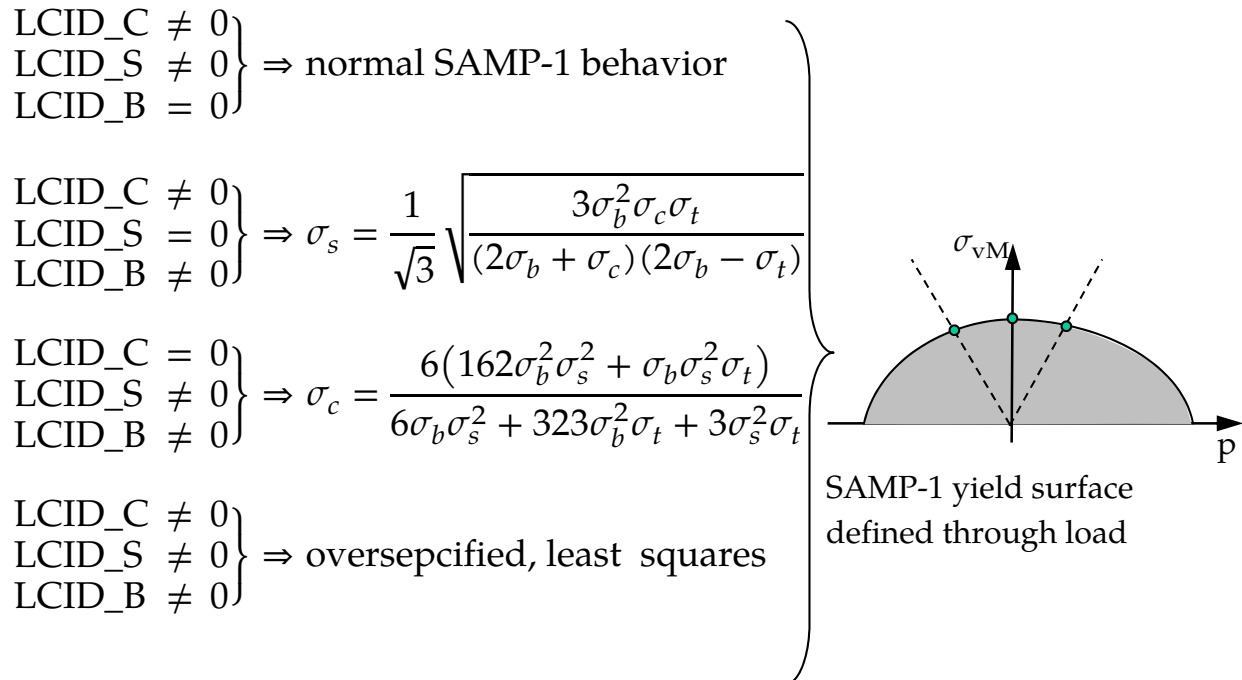

Remarks:

1. If the LCID_D is given, then a damage curve as a function of equivalent plastic strains acting on the stresses is defined as depicted in the following picture. EP-FAIL and DEPRPT defined the failure and fading behaviour of a single element:

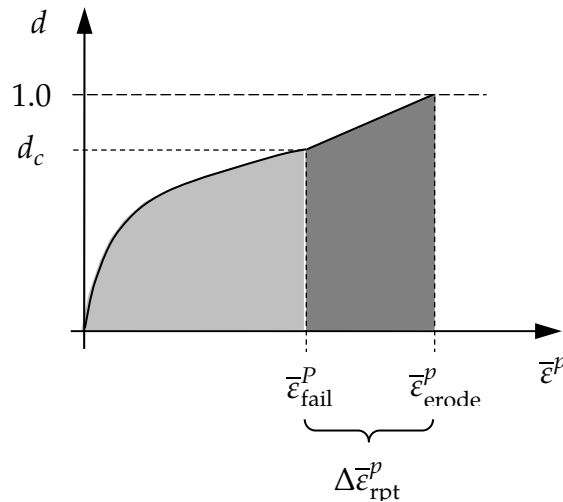
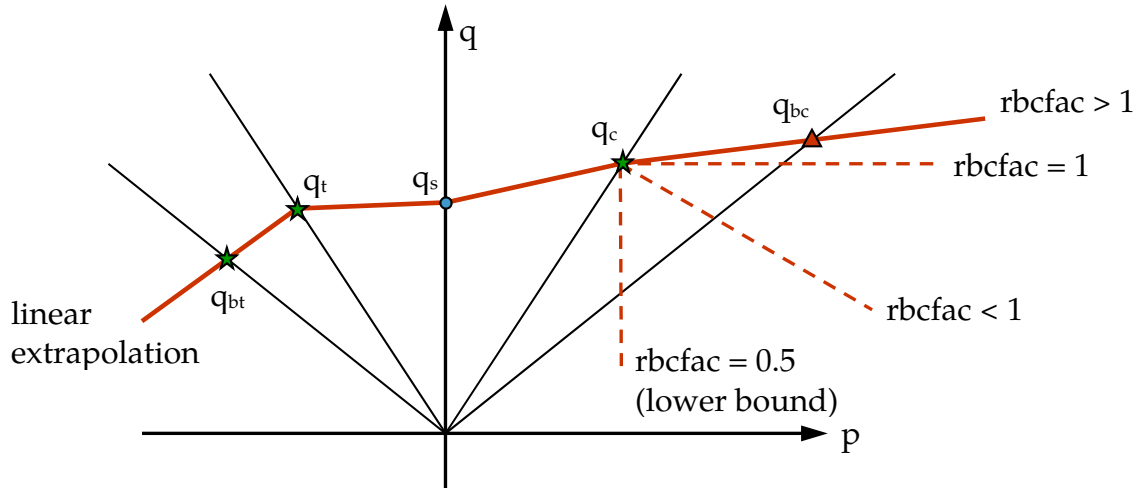

Figure 2-106

Since the damaging curve acts on the yield values, the inelastic results are effected by the damage curve. As a means to circumvent this, the load curve LCID-D may be given a negative ID. This will lead to an internal conversion of from nominal to effective stresses (ASSR).

2. Since the generality of arbitrary curve inputs allows to generate unsolvable yield surfaces, SAMP may modify curves internally. This will always lead to warning messages at the beginning of the simulation run. One modification that is not allowed are negative tangents of the last two data points of any of the yield curves.
3. If RBCFAC is nonzero the yield surface in I_1 - σ_{vm} -stress space is constructed such, that a multi-linear yield surface is gained. RBCFAC allows to modify then behavior in biaxial compression.
4. Extra history variables are as follows: 2 = plastic strain in tension/compression, 3 = plastic strain in shear, 4 = biaxial plastic strain, 5 = damage, 6 = volumetric plastic strain, 16 = plastic strain rate in tension/compression, 17 = plastic strain rate in shear, and 18 = biaxial plastic strain rate.



q	von Mises stress	bt	biaxial tension
p	pressure	t	tension
★	required input data	s	shear
●	optional input data	c	compression
▲	extrapolated data	bc	biaxial compression

$$rbcfac = \frac{q_{bc}}{q_c}$$

MAT_188**MAT_THERMO_ELASTO_VISCOPLASTIC_CREEP*****MAT_THERMO_ELASTO_VISCOPLASTIC_CREEP**

This is Material Type 188. In this model, creep is described separately from plasticity using Garafalo's steady-state hyperbolic sine creep law or Norton's power law. Viscous effects of plastic strain rate are considered using the Cowper-Symonds model. Young's modulus, Poisson's ratio, thermal expansion coefficient, yield stress, material parameters of Cowper-Symonds model as well as the isotropic and kinematic hardening parameters are all assumed to be temperature dependent. Application scope includes: simulation of solder joints in electronic packaging, modeling of tube brazing process, creep age forming, etc.

Card 1	1	2	3	4	5	6	7	8
Variable	MID	R0	E	PR	SIGY	ALPHA	LCSS	REFTEM
Type	A8	F	F	F	F	F	F	F

Card 2	1	2	3	4	5	6	7	8
Variable	QR1	CR1	QR2	CR2	QX1	CX1	QX2	CX2
Type	F	F	F	F	F	F	F	F

Card 3	1	2	3	4	5	6	7	8
Variable	C	P	LCE	LCPR	LCSIGY	LCQR	LCQX	LCALPH
Type	F	F	F	F	F	F	F	F

Card 4	1	2	3	4	5	6	7	8
Variable	LCC	LCP	LCCR	LCCX	CRPA	CRPB	CRPQ	CRPM
Type	F	F	F	F	F	F	F	F

Optional card 5

Card 5	1	2	3	4	5	6	7	8
Variable	CRPLAW							
Type	F							

VARIABLE**DESCRIPTION**

MID	Material identification. A unique number or label not exceeding 8 characters must be specified.
RO	Mass density.
E	Young's modulus
PR	Poisson's ratio
SIGY	Initial yield stress
ALPHA	Thermal expansion coefficient
LCSS	Load curve ID or Table ID. The load curve ID defines effective stress versus effective plastic strain. The table ID defines for each temperature value a load curve ID giving the stress versus effective plastic strain for that rate. The stress versus effective plastic strain curve for the lowest value of temperature is used if the temperature falls below the minimum value. Likewise, the stress versus effective plastic strain curve for the highest value of temperature is used if the temperature exceeds the maximum value. Card 2 is ignored with this option.
REFTEM	Reference temperature that defines thermal expansion coefficient
QR1	Isotropic hardening parameter Q_{r1}
CR1	Isotropic hardening parameter C_{r1}
QR2	Isotropic hardening parameter Q_{r2}
CR2	Isotropic hardening parameter C_{r2}
QX1	Kinematic hardening parameter $Q_{\chi1}$
CX1	Kinematic hardening parameter $C_{\chi1}$

VARIABLE	DESCRIPTION
QX2	Kinematic hardening parameter $Q_{\chi 2}$
CX2	Kinematic hardening parameter $C_{\chi 2}$
C	Viscous material parameter C
P	Viscous material parameter P
LCE	Load curve for scaling Young's modulus as a function of temperature
LCPR	Load curve for scaling Poisson's ratio as a function of temperature
LCSIGY	Load curve for scaling initial yield stress as a function of temperature
LCQR	Load curve for scaling the isotropic hardening parameters QR1 and QR2 or the stress given by the load curve LCSS as a function of temperature
LCQX	Load curve for scaling the kinematic hardening parameters QX1 and QX2 as a function of temperature
LCALPH	Load curve for scaling the thermal expansion coefficient as a function of temperature
LCC	Load curve for scaling the viscous material parameter C as a function of temperature
LCP	Load curve for scaling the viscous material parameter P as a function of temperature
LCCR	Load curve for scaling the isotropic hardening parameters CR1 and CR2 as a function of temperature
LCCX	Load curve for scaling the isotropic hardening parameters CX1 and CX2 as a function of temperature
CRPA	Creep law parameter A GT.0.0: Constant value LT.0.0: Load curve ID = (-CRPA) which defines A as a function of temperature.

VARIABLE	DESCRIPTION
CRPB	Creep law parameter B GT.0.0: Constant value LT.0.0: Load curve ID = (-CRPB) which defines B as a function of temperature.
CRPQ	Creep law parameter Q GT.0.0: Constant value LT.0.0: Load curve ID = (-CRPQ) which defines Q as a function of temperature.
CRPM	Creep law parameter m GT.0.0: Constant value LT.0.0: Load curve ID = (-CRPM) which defines m as a function of temperature.
CRPLAW	Creep law definition (see Remarks): EQ.0.0: Garofalo's hyperbolic sine law (default). EQ.1.0: Norton's power law.

Remarks:

If LCSS is not given any value the uniaxial stress-strain curve has the form

$$\sigma(\varepsilon_{\text{eff}}^p) = \sigma_0 + Q_{r1}[1 - \exp(-C_{r1}\varepsilon_{\text{eff}}^p)] + Q_{r2}[1 - \exp(-C_{r2}\varepsilon_{\text{eff}}^p)] \\ + Q_{\chi1}[1 - \exp(-C_{\chi1}\varepsilon_{\text{eff}}^p)] + Q_{\chi2}[1 - \exp(-C_{\chi2}\varepsilon_{\text{eff}}^p)].$$

Viscous effects are accounted for using the Cowper-Symonds model, which scales the yield stress with the factor:

$$1 + \left(\frac{\dot{\varepsilon}_{\text{eff}}^p}{C}\right)^{1/p}.$$

For CRPLAW = 0, the steady-state creep strain rate of Garafalo's hyperbolic sine equation is given by

$$\dot{\varepsilon}^c = A[\sinh(B\tau^e)]^m \exp\left(-\frac{Q}{T}\right).$$

For CRPLAW = 1, the steady-state creep strain rate is given by Norton's power law equation:

$$\dot{\epsilon}^c = A(\tau^e)^B t^m.$$

In the above, τ^e is the effective elastic stress in the von Mises sense, T is the temperature and t is the time. The following is a schematic overview of the resulting stress update. The multiaxial creep strain increment is given by

$$\Delta\epsilon^c = \Delta\epsilon^c \frac{3\tau^e}{2\tau^e}$$

where τ^e is the elastic deviatoric stress tensor. Similarly the plastic and thermal strain increments are given by

$$\Delta\epsilon^p = \Delta\epsilon^p \frac{3\tau^e}{2\tau^e}$$

$$\Delta\epsilon^T = \alpha_{t+\Delta t}(T - T_{\text{ref}})\mathbf{I} - \epsilon_t^T$$

where α is the thermal expansion coefficient (note the definition compared to that of other materials). Adding it all together, the stress update is given by

$$\sigma_{t+\Delta t} = \mathbf{C}_{t+\Delta t}(\epsilon_t^e + \Delta\epsilon - \Delta\epsilon^p - \Delta\epsilon^c - \Delta\epsilon^T)$$

The plasticity is isotropic or kinematic but with a von Mises yield criterion, the subscript in the equation above indicates the simulation time of evaluation. Internally, this stress update requires the solution of a nonlinear equation in the effective stress, the viscoelastic strain increment and potentially the plastic strain increment.

***MAT_ANISOTROPIC_THERMOELASTIC**

This is Material Type 189. This model characterizes elastic materials whose elastic properties are temperature-dependent.

Card 1	1	2	3	4	5	6	7	8
Variable	MID	R0	TA1	TA2	TA3	TA4	TA5	TA6
Type	A8	F	F	F	F	F	F	F

Card 2	1	2	3	4	5	6	7	8
Variable	C11	C12	C13	C14	C15	C16	C22	C23
Type	F	F	F	F	F	F	F	F

Card 3	1	2	3	4	5	6	7	8
Variable	C24	C25	C26	C33	C34	C35	C36	C44
Type	F	F	F	F	F	F	F	F

Card 4	1	2	3	4	5	6	7	8
Variable	C45	C46	C55	C56	C66	TGE	TREF	AOPT
Type	F	F	F	F	F	F	F	F

Card 5	1	2	3	4	5	6	7	8
Variable	XP	YP	ZP	A1	A2	A3	MACF	
Type	F	F	F	F	F	F	F	

Card 6	1	2	3	4	5	6	7	8
Variable	V1	V2	V3	D1	D2	D3	BETA	REF
Type	F	F	F	F	F	F	F	F

VARIABLE**DESCRIPTION**

MID	Material identification. A unique number or label not exceeding 8 characters must be specified.
RO	Mass density.
TAi	Curve IDs defining the coefficients of thermal expansion for the six components of strain tensor as function of temperature.
CIJ	Curve IDs defining the 6×6 symmetric constitutive matrix in material coordinate system as function of temperature. Note that 1 corresponds to the <i>a</i> material direction, 2 to the <i>b</i> material direction, and 3 to the <i>c</i> material direction.
TGE	Curve ID defining the structural damping coefficient as function of temperature.
TREF	Reference temperature for the calculation of thermal loads or the definition of thermal expansion coefficients.
AOPT	Material axes option, (see MAT_ANISOTROPIC_ELASTIC/MAT_002 for a complete description.) <ul style="list-style-type: none"> EQ.0.0: locally orthotropic with material axes determined by element nodes 1, 2, and 4, as with *DEFINE_COORDINATE_NODES. EQ.1.0: locally orthotropic with material axes determined by a point in space and the global location of the element center; this is the a-direction. EQ.2.0: globally orthotropic with material axes determined by vectors defined below, as with *DEFINE_COORDINATE_VECTOR. EQ.3.0: locally orthotropic material axes determined by rotating the material axes about the element normal by an angle, BETA, from a line in the plane of the element defined by the cross product of the vector v with the element nor-

VARIABLE	DESCRIPTION
	mal. EQ.4.0: locally orthotropic in cylindrical coordinate system with the material axes determined by a vector \mathbf{v} , and an originating point, P , which define the centerline axis. LT.0.0: the absolute value of AOPT is a coordinate system ID number (CID on *DEFINE_COORDINATE_NODES, *DEFINE_COORDINATE_SYSTEM or *DEFINE_COORDINATE_VECTOR). Available in R3 version of 971 and later.
XP, YP, ZP	XP, YP, ZP define coordinates of point \mathbf{p} for AOPT = 1 and 4.
A1, A2, A3	a1, a2, a3 define components of vector \mathbf{a} for AOPT = 2.
MACF	Material axis change flag for brick elements (see MAT_002 for a complete description.)
D1, D2, D3	d1, d2, d3 define components of vector \mathbf{d} for AOPT = 2.
V1, V2, V3	v1, v2, v3 define components of vector \mathbf{v} for AOPT = 3 and 4.
BETA	Material angle in degrees for AOPT = 3, may be overwritten on the element card, see *ELEMENT_SOLID_ORTHO.
REF	Use initial geometry to initialize the stress tensor (see MAT_002 for a complete description.)

***MAT_FLD_3-PARAMETER_BARLAT**

This is Material Type 190. This model was developed by Barlat and Lian [1989] for modeling sheets with anisotropic materials under plane stress conditions. This material allows the use of the Lankford parameters for the definition of the anisotropy. This particular development is due to Barlat and Lian [1989]. It has been modified to include a failure criterion based on the Forming Limit Diagram. The curve can be input as a load curve, or calculated based on the n-value and sheet thickness.

Card 1	1	2	3	4	5	6	7	8
Variable	MID	R0	E	PR	HR	P1	P2	ITER
Type	A8	F	F	F	F	F	F	F

Card 2	1	2	3	4	5	6	7	8
Variable	M	R00	R45	R90	LCID	E0	SPI	P3
Type	F	F	F	F	I	F	F	F

Card 3	1	2	3	4	5	6	7	8
Variable	AOPT	C	P	FLDCID	RN	RT	FLDSAFE	FLDNIPF
Type	F	F	F	I	F	F	F	F

Card 4	1	2	3	4	5	6	7	8
Variable				A1	A2	A3		
Type				F	F	F		

Card 5	1	2	3	4	5	6	7	8
Variable	V1	V2	V3	D1	D2	D3	BETA	
Type	F	F	F	F	F	F	F	

VARIABLE**DESCRIPTION**

MID	Material identification. A unique number or label not exceeding 8 characters must be specified.
RO	Mass density.
E	Young's modulus, E
PR	Poisson's ratio, ν
HR	Hardening rule: EQ.1.0: linear (default), EQ.2.0: exponential (Swift) EQ.3.0: load curve EQ.4.0: exponential (Voce) EQ.5.0: exponential (Gosh) EQ.6.0: exponential (Hockett-Sherby)
P1	Material parameter: HR.EQ.1.0: Tangent modulus, HR.EQ.2.0: k, strength coefficient for Swift exponential hardening HR.EQ.4.0: a, coefficient for Voce exponential hardening HR.EQ.5.0: k, strength coefficient for Gosh exponential hardening HR.EQ.6.0: a, coefficient for Hockett-Sherby exponential hardening

VARIABLE	DESCRIPTION
P2	Material parameter: HR.EQ.1.0: Yield stress HR.EQ.2.0: n, exponent for Swift exponential hardening HR.EQ.4.0: c, coefficient for Voce exponential hardening HR.EQ.5.0: n, exponent for Gosh exponential hardening HR.EQ.6.0: c, coefficient for Hocket-Sherby exponential hardening
ITER	Iteration flag for speed: ITER.EQ.0.0: fully iterative ITER.EQ.1.0: fixed at three iterations Generally, ITER = 0 is recommended. However, ITER = 1 is somewhat faster and may give acceptable results in most problems.
M	m, exponent in Barlat's yield surface
R00	R ₀₀ , Lankford parameter determined from experiments
R45	R ₄₅ , Lankford parameter determined from experiments
R90	R ₉₀ , Lankford parameter determined from experiments
LCID	load curve ID for the load curve hardening rule
E0	Material parameter HR.EQ.2.0: ϵ_0 for determining initial yield stress for Swift exponential hardening. (Default = 0.0) HR.EQ.4.0: b, coefficient for Voce exponential hardening HR.EQ.5.0: ϵ_0 for determining initial yield stress for Gosh exponential hardening. (Default = 0.0) HR.EQ.6.0: b, coefficient for Hocket-Sherby exponential hardening

VARIABLE	DESCRIPTION
SPI	<p>If ε_0 is zero above and HR.EQ.2.0. (Default = 0.0)</p> <p>EQ.0.0: $\varepsilon_0 = (E/k)^{1/(n-1)}$</p> <p>LE.0.2: $\varepsilon_0 = \text{SPI}$</p> <p>GT.0.2: $\varepsilon_0 = (\text{SPI}/k)^{1/n}$</p>
P3	<p>Material parameter:</p> <p>HR.EQ.5.0: p, parameter for Gosh exponential hardening</p> <p>HR.EQ.6.0: n, exponent for Hocket-Sherby exponential hardening</p>
AOPT	<p>Material axes option (see MAT_OPTION TROPIC_ELASTIC for a more complete description):</p> <p>EQ.0.0: locally orthotropic with material axes determined by element nodes 1, 2, and 4, as with *DEFINE_COORDINATE_NODES, and then rotated about the shell element normal by the angle BETA.</p> <p>EQ.2.0: globally orthotropic with material axes determined by vectors defined below, as with *DEFINE_COORDINATE_VECTOR.</p> <p>EQ.3.0: locally orthotropic material axes determined by rotating the material axes about the element normal by an angle, BETA, from a line in the plane of the element defined by the cross product of the vector v with the element normal.</p> <p>LT.0.0: the absolute value of AOPT is a coordinate system ID number (CID on *DEFINE_COORDINATE_NODES, *DEFINE_COORDINATE_SYSTEM or *DEFINE_COORDINATE_VECTOR). Available in R3 version of 971 and later.</p>
C	C in Cowper-Symonds strain rate model
P	p in Cowper-Symonds strain rate model, p = 0.0 for no strain rate effects

VARIABLE	DESCRIPTION
FLDCID	Load curve ID defining the Forming Limit Diagram. Minor strains in percent are defined as abscissa values and Major strains in percent are defined as ordinate values. The forming limit diagram is shown in Figure 2-28 . In defining the curve list pairs of minor and major strains starting with the left most point and ending with the right most point, see *DEFINE_CURVE.
RN	Hardening exponent equivalent to the n-value in a power law hardening law. If the parameter FLDCID is not defined, this value in combination with the value RT can be used to calculate a forming limit curve to allow for failure.
RT	Sheet thickness used for calculating a forming limit curve. This value does not override the sheet thickness in any way. It is only used in conjunction with the parameter RN to calculate a forming limit curve if the parameter FLDCID is not defined.
FLDSAFE	A safety offset of the forming limit curve. This value should be input as a percentage (ex. 10 not 0.10). This safety margin will be applied to the forming limit curve defined by FLDCID or the curve calculated by RN and RT.
FLDNIPF	Numerical integration points failure treatment. <p>GT.0.0: The number of element integration points that must fail before the element is deleted. By default, if one integration point has strains above the forming limit curve, the element is flagged for deletion.</p> <p>LT.0.0: The element is deleted when all integration points within a relative distance of -FLDNIPF from the mid surface have failed (value between -1.0 and 0.0).</p>
A1, A2, A3	Components of vector a for AOPT = 2.
V1, V2, V3	Components of vector v for AOPT = 3.
D1, D2, D3	Components of vector d for AOPT = 2.
BETA	Material angle in degrees for AOPT = 0 and 3, may be overridden on the element card, see *ELEMENT_SHELL_BETA.

Remarks:

See material 36 for the theoretical basis.

The forming limit curve can be input directly as a curve by specifying a load curve id with the parameter FLDCID. When defining such a curve, the major and minor strains must be input as percentages.

Alternatively, the parameters RN and RT can be used to calculate a forming limit curve. The use of RN and RT is not recommended for non-ferrous materials. RN and RT are ignored if a non-zero FLDCID is defined.

The first history variable is the maximum strain ratio defined by:

$$\frac{\varepsilon_{\text{major_workpiece}}}{\varepsilon_{\text{major_fld}}}$$

corresponding to $\varepsilon_{\text{minor_workpiece}}$. A value between 0 and 1 indicates that the strains lie below the forming limit curve. Values above 1 indicate that the strains are above the forming limit curve.

***MAT_SEISMIC_BEAM**

Purpose: This is Material Type 191. This material enables lumped plasticity to be developed at the 'node 2' end of Belytschko-Schwer beams (resultant formulation). The plastic yield surface allows interaction between the two moments and the axial force.

Card 1	1	2	3	4	5	6	7	8
Variable	MID	RO	E	PR	ASFLAG	FTYPE	DEGRAD	IFEMA
Type	A8	F	F	F	F	I	I	I
Default	none	none	none	none	0.0	1	0	0

Card 2	1	2	3	4	5	6	7	8
Variable	LCPMS	SFS	LCPMT	SFT	LCAT	SFAT	LCAC	SFAC
Type	F	F	F	F	F	F	F	F
Default	none	1.0	LCMPS	1.0	none	1.0	LCAT	1.0

This card 3 format is used when FTYPE = 1 (default).

Card 3	1	2	3	4	5	6	7	8
Variable	ALPHA	BETA	GAMMA	DELTA	A	B	FOFFS	
Type	F	F	F	F	F	F	F	
Default	see note	see note	see note	see note	see note	see note	0.0	

This card 3 format is used when FTYPE = 2.

Card 3	1	2	3	4	5	6	7	8
Variable	SIGY	D	W	TF	TW			
Type	F	F	F	F	F			
Default	none	none	none	none	none			

This card 3 format is used when FTYPE = 4.

Card 3	1	2	3	4	5	6	7	8
Variable	PHI_T	PHI_C	PHI_B					
Type	F	F	F					
Default	0.8	0.85	0.9					

This card 3 format is used when FTYPE = 5.

Card 3	1	2	3	4	5	6	7	8
Variable	ALPHA	BETA	GAMMA	DELTA	PHI_T	PHI_C	PHI_B	
Type	F	F	F	F	F	F	F	
Default	none	none	1.4	none	1.0	1.0	1.0	

FEMA limits Card 1. Additional card for IFEMA > 0.

Card 4	1	2	3	4	5	6	7	8
Variable	PR1	PR2	PR3	PR4				
Type	F	F	F	F				
Default	0	0	0	0				

FEMA limits Card 2. Additional card for IFEMA = 2.

Card 5	1	2	3	4	5	6	7	8
Variable	TS1	TS2	TS3	TS4	CS1	CS2	CS3	CS4
Type	F	F	F	F	F	F	F	F
Default	0	0	0	0	TS1	TS2	TS3	TS4

VARIABLE**DESCRIPTION**

MID	Material identification. A unique number or label not exceeding 8 characters must be specified.
RO	Mass density.
E	Young's modulus.
PR	Poisson's ratio.
ASFLAG	Axial strain definition for force-strain curves, degradation and FEMA output: EQ.0.0: true (log) total strain EQ.1.0: change in length EQ.2.0: nominal total strain EQ.3.0: FEMA plastic strain (= nominal total strain minus elastic strain)

VARIABLE	DESCRIPTION
FTYPE	Formulation type for interaction EQ.1: Parabolic coefficients, axial load and biaxial bending (default). EQ.2: Japanese code, axial force and major axis bending. EQ.4: AISC utilization calculation but no yielding EQ.5: AS4100 utilization calculation but no yielding
DEGRADE	Flag for degrading moment behavior (see Remarks) EQ.0: Behavior as in previous versions EQ.1: Fatigue-type degrading moment-rotation behavior EQ.2: FEMA-type degrading moment-rotation behavior
IFEMA	Flag for input of FEMA thresholds EQ.0: No input EQ.1: Input of rotation thresholds only EQ.2: Input of rotation and axial strain thresholds
LCPMS	Load curve ID giving plastic moment vs. Plastic rotation at node 2 about local s-axis. See *DEFINE_CURVE.
SFS	Scale factor on s-moment at node 2.
LCPMT	Load curve ID giving plastic moment vs. Plastic rotation at node 2 about local t-axis. See *DEFINE_CURVE.
SFT	Scale factor on t-moment at node 2.
LCAT	Load curve ID giving axial tensile yield force vs. total tensile (elastic + plastic) strain or vs. elongation. See AOPT above. All values are positive. See *DEFINE_CURVE.
SFAT	Scale factor on axial tensile force.
LCAC	Load curve ID giving compressive yield force vs. total compressive (elastic + plastic) strain or vs. elongation. See AOPT above. All values are positive. See *DEFINE_CURVE.
SFAC	Scale factor on axial tensile force.
ALPHA	Parameter to define yield surface.

VARIABLE	DESCRIPTION
BETA	Parameter to define yield surface.
GAMMA	Parameter to define yield surface.
DELTA	Parameter to define yield surface.
A	Parameter to define yield surface.
B	Parameter to define yield surface.
FOFFS	Force offset for yield surface (see Remarks).
SIGY	Yield stress of material.
D	Depth of section used to calculate interaction curve.
W	Width of section used to calculate interaction curve.
TF	Flange thickness of section used to calculate interaction curve.
TW	Web thickness used to calculate interaction curve.
PHI_T	Factor on tensile capacity, ϕ_t
PHI_C	Factor on compression capacity, ϕ_c
PHI_B	Factor on bending capacity, ϕ_b
PR1 - PR4	Plastic rotation thresholds 1 to 4
TS1 - TS4	Tensile axial strain thresholds 1 to 4
CS1 - CS4	Compressive axial strain thresholds 1 to 4

Remarks:

Yield surface for formulation type 1 is of the form:

$$\psi = \left(\frac{M_s}{M_{ys}} \right)^\alpha + \left(\frac{M_t}{M_{yt}} \right)^\beta + A \left(\frac{F}{F_y} \right)^\gamma + B \left(\frac{F}{F_y} \right)^\delta - 1$$

Where,

M_s, M_t = moments about local s and t axes

M_{ys}, M_{yt} = current yield moments

F = axial force

F_y = Yield force; LCAC in compression or LCAT in tension

$\alpha, \beta, \gamma, \delta$ = Input parameters; must be greater than or equal to 1.1

A, B = input parameters

If $\alpha, \beta, \gamma, \delta, A$ and B are all set to zero then the following default values are used:

ALPHA	=	2.0
BETA	=	2.0
GAMMA	=	2.0
DELTA	=	4.0
A	=	2.0
B	=	-1.0

FOFFS offsets the yield surface parallel to the axial force axis. It is the compressive axial force at which the maximum bending moment capacity about the local s-axis (determined by LCPMS and SFS), and that about the local t-axis (determined by LCPMT and SFT), occur. For steel beams and columns, the value of FOFFS is usually zero. For reinforced concrete beams, columns and shear walls, the maximum bending moment capacity occurs corresponding to a certain compressive axial force, FOFFS. The value of FOFFS can be input as either positive or negative. Internally, LS-DYNA converts FOFFS to, and regards compressive axial force as, negative.

Interaction surface FTYPE 4 calculates a utilisation parameter using the yield force and moment data given on card 2, but the elements remain elastic even when the forces or moments exceed yield values. This is done for consistency with the design code OBE AISC LRFD (2000). The utilisation calculation is as follows:

$$\text{Utilisation} = \frac{K_1 F}{\phi F_y} + \frac{K_2}{\phi_b} \left(\frac{M_s}{M_{ys}} + \frac{M_t}{M_{yt}} \right)$$

where,

$M_s, M_t, M_{ys}, M_{yt}, F_y$ are defined as in the preceding equation

and,

ϕ = from PHI_T under tension; PHI_C under compression

ϕ_b = take from PHI_B

$$K_1 = \begin{cases} 0.5 & \frac{F}{\phi F_y} < 0.2 \\ 1.0 & \frac{F}{\phi F_y} \geq 0.2 \end{cases}$$

$$K_2 = \begin{cases} 1.0 & \frac{F}{\phi F_y} < 0.2 \\ 8/9 & \frac{F}{\phi F_y} \geq 0.2 \end{cases}$$

Interaction surface FTYPE 5 is similar to type 4 (calculates a utilisation parameter using the yield data, but the elements do not yield). The equations are taken from Australian code AS4100. The user must select appropriate values of α , β , γ and δ using the various clauses of Section 8 of AS4100. It is assumed that the local s-axis is the major axis for bending.

$$\text{Utilisation} = \max(U_1, U_2, U_3, U_4, U_5)$$

$$U_1 = \frac{F}{\beta \phi_c F_{yc}} \quad \text{used for members in compression}$$

$$U_2 = \frac{F}{\phi_t F_{yt}} \quad \text{used for members in tension}$$

$$U_3 = \left[\frac{M_s}{K_2 \phi_b M_{ys}} \right]^\gamma + \left[\frac{M_t}{K_1 \phi_b M_{yt}} \right]^\gamma \quad \text{used for members in compression}$$

$$U_4 = \left[\frac{M_s}{K_4 \phi_b M_{ys}} \right]^\gamma + \left[\frac{M_t}{K_3 \phi_b M_{yt}} \right]^\gamma \quad \text{used for members in tension}$$

$$U_5 = \frac{F}{\phi_c F_{yc}} + \frac{M_s}{\phi_b M_{ys}} + \frac{M_t}{\phi_b M_{yt}} \quad \text{used for all members}$$

where,

$M_s, M_t, F, M_{ys}, M_{yt}, F_{yt}, F_{yc}$ are as defined above

and,

$$K_1 = 1.0 - \frac{F}{\beta \phi_c F_{yc}}$$

$$K_2 = \min \left[K_1, \alpha \left(1.0 - \frac{F}{\delta \phi_c F_{yc}} \right) \right]$$

$$K_3 = 1.0 - \frac{F}{\phi_t F_{yt}}$$

$$K_4 = \min \left[K_3, \alpha \left(1.0 + \frac{F}{\phi_t F_{yt}} \right) \right]$$

where

K_1, K_2, K_3, K_4 are subject to a minimum value of 10^{-6} ,

$\alpha, \beta, \gamma, \delta, \phi_t, \phi_c, \phi_b$ are input parameters

The option for degrading moment behavior changes the meaning of the plastic moment-rotation curve as follows:

If $DEGRAD = 0$ (not recommended), the x-axis points on the curve represent current plastic rotation (i.e. total rotation minus the elastic component of rotation). This quantity can be positive or negative depending on the direction of rotation; during hysteresis the behavior will repeatedly follow backwards and forwards along the same curve. The curve should include negative and positive rotation and moment values. This option is retained so that results from existing models will be unchanged.

If $DEGRAD = 1$, the x-axis points represent cumulative absolute plastic rotation. This quantity is always positive, and increases whenever there is plastic rotation in either direction. Thus, during hysteresis, the yield moments are taken from points in the input curve with increasingly positive rotation. If the curve shows a degrading behavior (reducing moment with rotation), then, once degraded by plastic rotation, the yield moment can never recover to its initial value. This option can be thought of as having “fatigue-type” hysteretic damage behavior, where all plastic cycles contribute to the total damage.

If $DEGRAD = 2$, the x-axis points represent the high-tide value (always positive) of the plastic rotation. This quantity increases only when the absolute value of plastic rotation exceeds the previously recorded maximum. If smaller cycles follow a larger cycle, the plastic moment during the small cycles will be constant, since the high-tide plastic rotation is not altered by the small cycles. Degrading moment-rotation behavior is possible. This option can be thought of as showing rotation-controlled damage, and follows the FEMA approach for treating fracturing joints.

$DEGRAD$ applies also to the axial behavior. The same options are available as for rotation: $DEGRAD = 0$ gives unchanged behavior from previous versions; $DEGRAD = 1$ gives a fatigue-type behavior using cumulative plastic strain; and $DEGRAD = 2$ gives FEMA-type behavior, where the axial load capacity depends on the high-tide tensile and compressive strains. The definition of strain for this purpose is according to AOPT on Card 1 – it is expected that $AOPT = 2$ will be used with $DEGRAD = 2$. The “axial strain” variable plotted by post-processors is the variable defined by AOPT.

The output variables plotted as “plastic rotation” have special meanings for this material model as follows – note that hinges form only at Node 2:

“Plastic rotation at End 1” is really a high-tide mark of absolute plastic rotation at Node 2, defined as follows:

1. Current plastic rotation is the total rotation minus the elastic component of rotation.
2. Take the absolute value of the current plastic rotation, and record the maximum achieved up to the current time. This is the high-tide mark of plastic rotation.

If $DEGRAD = 0$, “Plastic rotation at End 2” is the current plastic rotation at Node 2.

If DEGRAD = 1 or 2, "Plastic rotation at End 2" is the current total rotation at Node 2.

The total rotation is a more intuitively understood parameter, e.g. for plotting hysteresis loops. However, with DEGRAD = 0, the previous meaning of that output variable has been retained such that results from existing models are unchanged.

FEMA thresholds are the plastic rotations at which the element is deemed to have passed from one category to the next, e.g. "Elastic", "Immediate Occupancy", "Life Safe", etc. The high-tide plastic rotation (maximum of Y and Z) is checked against the user-defined limits FEMA1, FEMA2, etc. The output flag is then set to 0, 1, 2, 3, or 4: 0 means that the rotation is less than FEMA1; 1 means that the rotation is between FEMA1 and FEMA2, and so on. By contouring this flag, it is possible to see quickly which joints have passed critical thresholds.

For this material model, special output parameters are written to the d3plot and d3thdt files. The number of output parameters for beam elements is automatically increased to 20 (in addition to the six standard resultants) when parts of this material type are present. Some post-processors may interpret this data as if the elements were integrated beams with 4 integration points. Depending on the post-processor used, the data may be accessed as follows:

Extra variable 16 (or Integration point 4 Axial Stress):	FEMA rotation flag
Extra variable 17 (or Integration point 4 XY Shear Stress):	Current utilization
Extra variable 18 (or Integration point 4 ZX Shear Stress):	Maximum utilization to date
Extra variable 20 (or Integration point 4 Axial Strain):	FEMA axial flag

"Utilization" is the yield parameter, where 1.0 is on the yield surface.

*MAT_SOIL_BRICK

Purpose: This is Material Type 192. It is intended for modeling over-consolidated clay.

Card 1	1	2	3	4	5	6	7	8
Variable	MID	RO	RLAMDA	RKAPPA	RIOTA	RBETA1	RBETA2	RMU
Type	A8	F	F	F	F	F	F	F
Default								1.0

Card 2	1	2	3	4	5	6	7	8
Variable	RNU	RLCID	TOL	PGCL	SUB-INC	BLK	GRAV	THEORY
Type	F	F	F	F	F	F	F	I
Default			0.0005				9.807	0

Additional card for THEORY > 0.

Card 3	1	2	3	4	5	6	7	8
Variable	RVHHH	XSICRIT	ALPHA	RVH	RNU21	ANISO_4		
Type	F	F	F	F	F	F		
Default	0	0	0	0	0	0		

VARIABLE

DESCRIPTION

- MID Material identification. A unique number or label not exceeding 8 characters must be specified.
- RO Mass density
- RLAMDA Material coefficient

VARIABLE	DESCRIPTION
RKAPPA	Material coefficient
RIOTA	Material coefficient
RBETA1	Material coefficient
RBETA2	Material coefficient
RMU	Shape factor coefficient. This parameter will modify the shape of the yield surface used. 1.0 implies a von Mises type surface, but 1.1 to 1.25 is more indicative of soils. The default value is 1.0.
RNU	Poisson's ratio
RLCID	Load curve identification number referring to a curve defining up to 10 pairs of 'string-length' vs G/Gmax points.
TOL	User defined tolerance for convergence checking. Default value is set to 0.02.
PGCL	Pre-consolidation ground level. This parameter defines the maximum surface level (relative to $z = 0.0$ in the model) of the soil throughout geological history. This is used calculate the maximum over burden pressure on the soil elements.
SUB-INC	User defined strain increment size. This is the maximum strain increment that the material model can normally cope with. If the value is exceeded a warning is echoed to the d3hsp file.
BLK	The elastic bulk stiffness of the soil. This is used for the contact stiffness only.
GRAV	The gravitational acceleration. This is used to calculate the element stresses due the overlying soil. Default is set to 9.807 m/s^2 .
THEORY	Version of material subroutines used (See Remarks). EQ.0: 1995 version, vectorized (Default) EQ.4: 2003 version, unvectorized
RVHHH	Anisotropy ratio G_{vh} / G_{hh} (default = Isotropic behavior)
XSICRIT	Anisotropy parameter
ALPHA	Anisotropy parameter

VARIABLE	DESCRIPTION
RVH	Anisotropy ratio E_v / E_h
RNU21	Anisotropy ratio ν_2 / ν_1
ANISO_4	Anisotropy parameter

Remarks:

1. This material type requires that the model is oriented such that the z-axis is defined in the upward direction. Compressive initial stress must be defined, e.g. using *INITIAL_STRESS_SOLID or *INITIAL_STRESS_DEPTH.

The recommended unit system is kN, meters, seconds, tonnes. There are some built-in defaults that assume stress units of KN/m².

Over-consolidated clays have suffered previous loading to higher stress levels than are present at the start of the analysis. This could have occurred due to ice sheets during previous ice ages, or the presence of soil or rock that has subsequently been eroded. The maximum vertical stress during that time is assumed to be:

$$\sigma_{VMAX} = RO \times GRAV \times (PGCL - Z_{el})$$

where

RO, GRAV, and PGCL = input parameters

Z_{el} = z coordinate of center of element

Since that time, the material has been unloaded until the vertical stress equals the user-defined initial vertical stress. The previous load/unload history has a significant effect on subsequent behavior, e.g. the horizontal stress in an over-consolidated clay may be greater than the vertical stress.

This material model creates a load/unload cycle for a sample element of each material of this type, stores in a scratch file the horizontal stress and history variables as a function of the vertical stress, and interpolates these quantities from the defined initial vertical stress for each element. Therefore the initial horizontal stress seen in the output files will be different from the input initial horizontal stress.

This material model is developed for a Geotechnical FE program (Oasys Ltd.'s SAFE) written by Arup. The default THEORY = 0 gives a vectorized version ported from SAFE in the 1990's. Since then the material model has been developed further in SAFE; the most recent porting is accessed using THEORY = 4 (recommended); however, this version is not vectorized and will run more slowly on most computer platforms.

2. The shape factor for a typical soil would be 1.25. Do not use values higher than 1.35.

***MAT_DRUCKER_PRAGER**

Purpose: This is Material Type 193. This material enables soil to be modeled effectively. The parameters used to define the yield surface are familiar geotechnical parameters (i.e. angle of friction). The modified Drucker-Prager yield surface is used in this material model enabling the shape of the surface to be distorted into a more realistic definition for soils.

Card 1	1	2	3	4	5	6	7	8
Variable	MID	RO	GMOD	RNU	RKF	PHI	CVAL	PSI
Type	A8	F	F	F	F	F	F	F
Default					1.0			0.0

Card 2	1	2	3	4	5	6	7	8
Variable	STR_LIM							
Type	F							
Default	0.005							

Card 3	1	2	3	4	5	6	7	8
Variable	GMODDP	PHIDP	CVALDP	PSIDP	GMODGR	PHIGR	CVALGR	PSIGR
Type	F	F	F	F	F	F	F	F
Default	0.0	0.0	0.0	0.0	0.0	0.0	0.0	0.0

VARIABLE**DESCRIPTION**

MID Material identification. A unique number or label not exceeding 8 characters must be specified.

RO Mass density

VARIABLE	DESCRIPTION
GMOD	Elastic shear modulus
RNU	Poisson's ratio
RKF	Failure surface shape parameter
PHI	Angle of friction (radians)
CVAL	Cohesion value
PSI	Dilation angle (radians)
STR_LIM	Minimum shear strength of material is given by STR_LIM*CVAL
GMODDP	Depth at which shear modulus (GMOD) is correct
PHIDP	Depth at which angle of friction (PHI) is correct
CVALDP	Depth at which cohesion value (CVAL) is correct
PSIDP	Depth at which dilation angle (PSI) is correct
GMODGR	Gradient at which shear modulus (GMOD) increases with depth
PHIGR	Gradient at which friction angle (PHI) increases with depth
CVALGR	Gradient at which cohesion value (CVAL) increases with depth
PSIGR	Gradient at which dilation angle (PSI) increases with depth

Remarks:

1. This material type requires that the model is oriented such that the z-axis is defined in the upward direction. The key parameters are defined such that may vary with depth (i.e. the z-axis).
2. The shape factor for a typical soil would be 0.8, but should not be pushed further than 0.75.
3. If STR_LIM is set to less than 0.005, the value is reset to 0.005.

***MAT_RC_SHEAR_WALL**

Purpose: This is Material Type 194. It is for shell elements only. It uses empirically-derived algorithms to model the effect of cyclic shear loading on reinforced concrete walls. It is primarily intended for modeling squat shear walls, but can also be used for slabs. Because the combined effect of concrete and reinforcement is included in the empirical data, crude meshes can be used. The model has been designed such that the minimum amount of input is needed: generally, only the variables on the first card need to be defined.

Card 1	1	2	3	4	5	6	7	8
Variable	MID	RO	E	PR	TMAX			I
Type	A8	F	F	F	F			
Default	none	none	none	0.0	0.0			

Include the following data if “Uniform Building Code” formula for maximum shear strength or tensile cracking are required – otherwise leave blank.

Card 2	1	2	3	4	5	6	7	8
Variable	FC	PREF	FYIELD	SIG0	UNCONV	ALPHA	FT	ERIENF
Type	F	F	F	F	F	F	F	F
Default	0.0	0.0	0.0	0.0	0.0	0.0	0.0	0.0

Card 3	1	2	3	4	5	6	7	8
Variable	A	B	C	D	E	F		
Type	F	F	F	F	F	F		
Default	0.05	0.55	0.125	0.66	0.25	1.0		

Card 4	1	2	3	4	5	6	7	8
Variable	Y1	Y2	Y3	Y4	Y5			
Type	F	F	F	F	F			
Default	0.0	0.0	0.0	0.0	0.0			

Card 5	1	2	3	4	5	6	7	8
Variable	T1	T2	T3	T4	T5			
Type	F	F	F	F	F			
Default	0.0	0.0	0.0	0.0	0.0			

Card 6	1	2	3	4	5	6	7	8
Variable	AOPT							
Type	F							
Default	0.0							

Card 7	1	2	3	4	5	6	7	8
Variable	XP	YP	ZP	A1	A2	A3		
Type	F	F	F	F	F	F		
Default	0.0	0.0	0.0	0.0	0.0	0.0		

Card 8	1	2	3	4	5	6	7	8
Variable	V1	V2	V3	D1	D2	D3	BETA	
Type	F	F	F	F	F	F	F	
Default	0.0	0.0	0.0	0.0	0.0	0.0	0.0	

VARIABLE**DESCRIPTION**

MID	Material identification. A unique number or label not exceeding 8 characters must be specified.
RO	Mass density
E	Young's Modulus
PR	Poisson's Ratio
TMAX	Ultimate in-plane shear stress. If set to zero, LS-DYNA will calculate TMAX based on the formulae in the Universal Building Code, using the data on card 2. See Remarks.
FC	Unconfined Compressive Strength of concrete (used in the calculation of ultimate shear stress; crushing behavior is not modeled)
PREF	Percent reinforcement, e.g. if 1.2% reinforcement, enter 1.2
FYIELD	Yield stress of reinforcement
SIG0	Overburden stress (in-plane compressive stress) - used in the calculation of ultimate shear stress. Usually sig0 is left as zero.
UCONV	Unit conversion factor. $UCONV = \sqrt{(1.0 \text{ psi in the model stress units})}$. This is needed because the ultimate tensile stress of concrete is expressed as $\sqrt{(FC)}$ where FC is in psi. Therefore a unit conversion factor of $\sqrt{(\text{psi}/\text{stress unit})}$ is required. Examples: $UCONV = 0.083$ if stress unit is MN/m ² or N/mm ² $UCONV = 83.3$ if stress unit is N/m ²
ALPHA	Shear span factor - see below.
FT	Cracking stress in direct tension - see notes below. Default is 8% of the cylinder strength.

VARIABLE	DESCRIPTION
ERIENF	Young's Modulus of reinforcement. Used in calculation of post-cracked stiffness - see notes below.
A	Hysteresis constants determining the shape of the hysteresis loops.
B	Hysteresis constants determining the shape of the hysteresis loops.
C	Hysteresis constants determining the shape of the hysteresis loops.
D	Hysteresis constants determining the shape of the hysteresis loops.
E	Hysteresis constants determining the shape of the hysteresis loops.
F	Strength degradation factor. After the ultimate shear stress has been achieved, F multiplies the maximum shear stress from the curve for subsequent reloading. F = 1.0 implies no strength degradation (default). F = 0.5 implies that the strength is halved for subsequent reloading.
Y1, Y2, ..., Y5	Shear strain points on stress-strain curve. By default these are calculated from the values on card 1. See below for more guidance.
T1, T2, ..., T5	Shear stress points on stress-strain curve. By default these are calculated from the values on card 1. See below for more guidance.
AOPT	<p>Material axes option:</p> <p>EQ.0.0: locally orthotropic with material axes determined by element nodes as shown in Figure 2-3, and then rotated about the shell element normal by the angle BETA. Nodes 1, 2, and 4 of an element are identical to the nodes used for the definition of a coordinate system as by *DEFINE_COORDINATE_NODES.</p> <p>EQ.2.0: globally orthotropic with material axes determined by vectors defined below, as with *DEFINE_COORDINATE_VECTOR.</p> <p>EQ.3.0: applicable to shell elements only. This option determines locally orthotropic material axes by offsetting the material axes by an angle to be specified from a line in the plane of the shell determined by taking the cross product of the vector v defined below with the shell normal vector.</p> <p>LT.0.0: the absolute value of AOPT is a coordinate system ID number (CID on *DEFINE_COORDINATE_NODES, *DEFINE_COORDINATE_SYSTEM or *DEFINE_COOR-</p>

VARIABLE	DESCRIPTION
	DINATE_VECTOR). Available in R3 version of 971 and later.
XP, YP, ZP	Coordinates of point p for AOPT = 1.
A1, A2, A3	Components of vector a for AOPT = 2.
V1, V2, V3	Components of vector v for AOPT = 3.
D1, D2, D3	Components of vector d for AOPT = 2.
BETA	Material angle in degrees for AOPT = 0 and 3, may be overridden on the element card, see *ELEMENT_SHELL_BETA.

Remarks:

The element is linear elastic except for in-plane shear and tensile cracking effects. Crushing due to direct compressive stresses are modeled only insofar as there is an in-plane shear stress component. It is not recommended that this model be used where nonlinear response to direct compressive or loads is important.

Note that the in-plane shear stress is defined as the shear stress in the element's local x-y plane (txy). This is not necessarily equal to the maximum shear stress in the plane: for example, if the principal stresses are at 45 degrees to the local axes, txy is zero. Therefore it is important to ensure that the local axes are appropriate - for a shear wall the local axes should be vertical or horizontal. By default, local X points from node 1 to node 2 of the element. It is possible to change the local axes by using AOPT > 0.

If TMAX is set to zero, the ultimate shear stress is calculated using a formula in the Uniform Building Code 1997, section 1921.6.5:

$$TMAX_{UBC} = UCONV \times ALPHA \times \sqrt{FC} + RO \times FY$$

where,

- UCONV = unit conversion factor, 0.083 for SI units (MN)
- ALPHA = aspect ratio, = 2.0 unless ratio h/l < 2.0 in which case alpha varies linearly from 2.0 at h/l = 2.0 to 3.0 at h/l = 1.5.
- FC = unconfined compressive strength of concrete
- RO = fraction of reinforcement = percent reinforcement/100
- FY = yield stress of reinforcement

To this we add shear stress due to the overburden to obtain the ultimate shear stress:

$$TMAX_{UBC} = TMAX_{UBC} + SIG0$$

where

SIG0 = in plane compressive stress under static equilibrium conditions

The UBC formula for ultimate shear stress is generally conservative (predicts that the wall is weaker than shown in test), sometimes by 50% or more. A less conservative formula is that of Fukuzawa:

$$TMAX = \max \left[\left(0.4 + \frac{A_c}{A_w} \right), 1 \right] \times 2.7 \times \left(1.9 + \frac{M}{L_v} \right) \times UCONV + \sqrt{FC} + 0.5 \times RO \times FY + SIG0$$

where

A_c = Cross-sectional area of stiffening features such as columns or flanges

A_w = Cross-sectional area of wall

M/L_v = Aspect ratio of wall (height/length)

Other terms are as above. This formula is not included in the material model: TMAX should be calculated by hand and entered on Card 1 if the Fukuzawa formula is required.

It should be noted that none of the available formulae, including Fukuzawa, predict the ultimate shear stress accurately for all situations. Variance from the experimental results can be as great as 50%.

The shear stress vs shear strain curve is then constructed automatically as follows, using the algorithm of Fukuzawa extended by Arup:

1. Assume ultimate shear strain, $\gamma_u = 0.0048$
2. First point on curve (concrete cracking) at $(0.3TMAX/G, 0.3TMAX)$ where G is the elastic shear modulus given by $E/2(1+\nu)$
3. Second point (reinforcement yield) at $(0.5\gamma_u, 0.8TMAX)$
4. Third point (ultimate strength) at $(\gamma_u, TMAX)$
5. Fourth point (onset of strength reduction) at $(2\gamma_u, TMAX)$
6. Fifth point (failure) at $(3\gamma_u, 0.6TMAX)$.

After failure, the shear stress drops to zero. The curve points can be entered by the user if desired, in which case they over-ride the automatically calculated curve. However, it is anticipated that in most cases the default curve will be preferred due to ease of input.

Hysteresis follows the algorithm of Shiga as for the squat shear wall spring (see *MAT_SPRING_SQUAT_SHEARWALL). The hysteresis constants A,B,C,D,E can be entered by the user if desired but it is generally recommended that the default values be used.

Cracking in tension is checked for the local x and y directions only – this is calculated separately from the in-plane shear. A trilinear response is assumed, with turning points at concrete cracking and reinforcement yielding. The three regimes are:

1. Pre-cracking, linear elastic response is assumed using the overall Young's Modulus on Card 1.
2. **Cracking occurs in the local x or y directions when the tensile stress in that direction exceeds the concrete tensile strength FT** (if not input on Card 2, this defaults to 8% of the compressive strength FC). Post-cracking, a linear stress-strain response is assumed up to reinforcement yield at a strain defined by reinforcement yield stress divided by reinforcement Young's Modulus.
3. Post-yield, a constant stress is assumed (no work hardening).

Unloading returns to the origin of the stress-strain curve.

For compressive strains the response is always linear elastic using the overall Young's Modulus on Card 1.

If insufficient data is entered, no cracking occurs in the model. As a minimum, FC and FY are needed.

Extra variables are available for post-processing as follows:

Extra variable 1: Current shear strain

Extra variable 2: Shear status: 0,1,2,3,4 or 5– see below

Extra variable 3: Maximum direct strain so far in local X direction (for tensile cracking)

Extra variable 4: Maximum direct strain so far in local Y direction (for tensile cracking)

Extra variable 5: Tensile status: 0,1 or 2 = elastic, cracked, or yielded respectively.

The shear status shows how far along the shear stress-strain curve each element has progressed, e.g. status 2 means that the element has passed the second point on the curve. These status levels correspond to performance criteria in building design codes such as FEMA.

***MAT_CONCRETE_BEAM**

This is Material Type 195 for beam elements. An elasto-plastic material with an arbitrary stress versus strain curve and arbitrary strain rate dependency can be defined. See also Remark below. Also, failure based on a plastic strain or a minimum time step size can be defined.

Card 1	1	2	3	4	5	6	7	8
Variable	MID	RO	E	PR	SIGY	ETAN	FAIL	TDEL
Type	A8	F	F	F	F	F	F	F
Default	none	none	none	none	none	0.0	10.E+20	10.E+20

Card 2	1	2	3	4	5	6	7	8
Variable	C	P	LCSS	LCSR				
Type	F	F	F	F				
Default	0	0	0	0				

Card 3	1	2	3	4	5	6	7	8
Variable	NOTEN	TENCUT	SDR					
Type	I	F	F					
Default	0	E15.0	0.0					

VARIABLE**DESCRIPTION**

MID Material identification. A unique number or label not exceeding 8 characters must be specified.

RO Mass density.

VARIABLE	DESCRIPTION
E	Young's modulus.
PR	Poisson's ratio.
SIGY	Yield stress.
ETAN	Tangent modulus, ignored if (LCSS.GT.0) is defined.
FAIL	Failure flag. LT.0.0: user defined failure subroutine is called to determine failure EQ.0.0: failure is not considered. This option is recommended if failure is not of interest since many calculations will be saved. GT.0.0: plastic strain to failure. When the plastic strain reaches this value, the element is deleted from the calculation.
TDEL	Minimum time step size for automatic element deletion.
C	Strain rate parameter, C, see formula below.
P	Strain rate parameter, P, see formula below.
LCSS	Load curve ID or Table ID. Load curve ID defining effective stress versus effective plastic strain. If defined EPS1-EPS8 and ES1-ES8 are ignored. The table ID defines for each strain rate value a load curve ID giving the stress versus effective plastic strain for that rate, See Figure 2-9 stress versus effective plastic strain curve for the lowest value of strain rate is used if the strain rate falls below the minimum value. Likewise, the stress versus effective plastic strain curve for the highest value of strain rate is used if the strain rate exceeds the maximum value. The strain rate parameters: C and P;
LCSR	Load curve ID defining strain rate scaling effect on yield stress.
NOTEN	No-tension flag, EQ.0: beam takes tension, EQ.1: beam takes no tension, EQ.2: beam takes tension up to value given by TENCUT.
TENCUT	Tension cutoff value.

VARIABLE	DESCRIPTION
SDR	Stiffness degradation factor.

Remarks:

The stress strain behavior may be treated by a bilinear stress strain curve by defining the tangent modulus, ETAN. An effective stress versus effective plastic strain curve (LCSS) may be input instead of defining ETAN. The cost is roughly the same for either approach. The most general approach is to use the table definition (LCSS) discussed below.

Three options to account for strain rate effects are possible.

1. Strain rate may be accounted for using the Cowper and Symonds model which scales the yield stress with the factor

$$1 + \left(\frac{\dot{\epsilon}}{C}\right)^{1/p}$$

where $\dot{\epsilon}$ is the strain rate. $\dot{\epsilon} = \sqrt{\dot{\epsilon}_{ij}\dot{\epsilon}_{ij}}$.

2. For complete generality a load curve (LCSR) to scale the yield stress may be input instead. In this curve the scale factor versus strain rate is defined.
3. If different stress versus strain curves can be provided for various strain rates, the option using the reference to a table (LCSS) can be used.

***MAT_GENERAL_SPRING_DISCRETE_BEAM**

This is Material Type 196. This model permits elastic and elastoplastic springs with damping to be represented with a discrete beam element type6 by using six springs each acting about one of the six local degrees-of-freedom. For elastic behavior, a load curve defines force or moment versus displacement or rotation. For inelastic behavior, a load curve yield force or moment versus plastic deflection or rotation, which can vary in tension and compression. The two nodes defining a beam may be coincident to give a zero length beam, or offset to give a finite length beam. For finite length discrete beams the absolute value of the variable SCOOR in the SECTION_BEAM input should be set to a value of 2.0, which causes the local r-axis to be aligned along the two nodes of the beam to give physically correct behavior. The distance between the nodes of a beam should not affect the behavior of this material model. A triad is used to orient the beam for the directional springs.

Card 1	1	2	3	4	5	6	7	8
Variable	MID	RO						
Type	A8	F						

Degree of Freedom Card Pairs. For each active degree of freedom include a pair of cards 2 and 3. This data is terminated by the next keyword ("*") card or when all six degrees of freedom have been specified.

Card 2	1	2	3	4	5	6	7	8
Variable	DOF	TYPE	K	D	CDF	TDF		
Type	I	I	F	F	F	F		

Card 3	1	2	3	4	5	6	7	8
Variable	FLCID	HLCID	C1	C2	DLE	GLCID		
Type	F	F	F	F	F	I		

VARIABLE	DESCRIPTION
MID	Material identification. A unique number or label not exceeding 8 characters must be specified.
RO	Mass density, see also volume in *SECTION_BEAM definition.
DOF	Active degree-of-freedom, a number between 1 and 6 inclusive. Each value of DOF can only be used once. The active degree-of-freedom is measured in the local coordinate system for the discrete beam element.
TYPE	The default behavior is elastic. For inelastic behavior input 1.
K	Elastic loading/unloading stiffness. This is required input for inelastic behavior.
D	Optional viscous damping coefficient.
CDF	Compressive displacement at failure. Input as a positive number. After failure, no forces are carried. This option does not apply to zero length springs. EQ.0.0: inactive.
TDF	Tensile displacement at failure. After failure, no forces are carried. EQ.0.0: inactive.
FLCID	Load curve ID, see *DEFINE_CURVE. For option TYPE = 0, this curve defines force or moment versus deflection for nonlinear elastic behavior. For option TYPE = 1, this curve defines the yield force versus plastic deflection. If the origin of the curve is at (0,0) the force magnitude is identical in tension and compression, i.e., only the sign changes. If not, the yield stress in the compression is used when the spring force is negative. The plastic displacement increases monotonically in this implementation. The load curve is required input.
HLCID	Load curve ID, see *DEFINE_CURVE, defining force versus relative velocity (Optional). If the origin of the curve is at (0,0) the force magnitude is identical for a given magnitude of the relative velocity, i.e., only the sign changes.
C1	Damping coefficient.
C2	Damping coefficient

VARIABLE	DESCRIPTION
DLE	Factor to scale time units.
GLCID	Optional load curve ID, see *DEFINE_CURVE, defining a scale factor versus deflection for load curve ID, HLCID. If zero, a scale factor of unity is assumed.

Remarks:

If TYPE = 0, elastic behavior is obtained. In this case, if the linear spring stiffness is used, the force, F , is given by:

$$F = F_0 + K \times \Delta L + D \times \Delta \dot{L}$$

but if the load curve ID is specified, the force is then given by:

$$F = F_0 + K f(\Delta L) \left[1 + C1 \times \Delta \dot{L} + C2 \times \text{sgn}(\Delta \dot{L}) \ln \left(\max \left\{ 1, \frac{|\Delta \dot{L}|}{DLE} \right\} \right) \right] + D \times \Delta \dot{L} \\ + g(\Delta L)h(\Delta \dot{L})$$

In these equations, ΔL is the change in length

$$\Delta L = \text{currentlength} - \text{initiallength}$$

If TYPE = 1, inelastic behavior is obtained. In this case, the yield force is taken from the load curve:

$$F^Y = F_y(\Delta L^{\text{plastic}})$$

where L^{plastic} is the plastic deflection. A trial force is computed as:

$$F^T = F^n + K \times \Delta \dot{L}(\Delta t)$$

and is checked against the yield force to determine F :

$$F = \begin{cases} F^Y & \text{if } F^T > F^Y \\ F^T & \text{if } F^T \leq F^Y \end{cases}$$

The final force, which includes rate effects and damping, is given by:

$$F^{n+1} = F \times \left[1 + C1 \times \Delta \dot{L} + C2 \times \text{sgn}(\Delta \dot{L}) \ln \left(\max \left\{ 1, \frac{|\Delta \dot{L}|}{DLE} \right\} \right) \right] + D \times \Delta \dot{L} + g(\Delta L)h(\Delta \dot{L})$$

Unless the origin of the curve starts at (0,0), the negative part of the curve is used when the spring force is negative where the negative of the plastic displacement is used to interpolate, F_y . The positive part of the curve is used whenever the force is positive.

The cross sectional area is defined on the section card for the discrete beam elements, See *SECTION_BEAM. The square root of this area is used as the contact thickness offset if these elements are included in the contact treatment.

***MAT_SEISMIC_ISOLATOR**

This is Material Type 197 for discrete beam elements. Sliding (pendulum) and elastomeric seismic isolation bearings can be modeled, applying bi-directional coupled plasticity theory. The hysteretic behavior was proposed by Wen [1976] and Park, Wen, and Ang [1986]. The sliding bearing behavior is recommended by Zayas, Low and Mahin [1990]. The algorithm used for implementation was presented by Nagarajaiah, Reinhorn, and Constantinou [1991]. Further options for tension-carrying friction bearings are as recommended by Roussis and Constantinou [2006]. Element formulation type 6 must be used. Local axes are defined on *SECTION_BEAM; the default is the global axis system. It is expected that the local z-axis will be vertical.

Card 1	1	2	3	4	5	6	7	8
Variable	MID	R0	A	GAMMA	BETA	DISPY	STIFFV	ITYPE
Type	A8	F	F	F	F	F	F	I
Default	none	none	1.0	0.5	0.5	0.0	0.0	0.0

Card 2	1	2	3	4	5	6	7	8
Variable	PRELOAD	DAMP	MX1	MX2	MY1	MY2		
Type	F	F	F	F	F	F		
Default	0	1.0	0	0	0	0		

Sliding Isolator Card. This card is used for ITYPE = 0 or 2. Leave this card *blank* for elastomeric isolator (TYPE = 1).

Card 3	1	2	3	4	5	6	7	8
Variable	FMAX	DELF	AFRIC	RADX	RADY	RADB	STIFFL	STIFFTS
Type	F	F	F	F	F	F	F	F
Default	0	0	0	1.0e20	1.0e20	1.0e20	STIFFV	0

Card 4 for ITYPE = 1 or 2. leave blank for sliding isolator ITYPE = 0:

Card 4	1	2	3	4	5	6	7	8
Variable	FORCEY	ALPHA	STIFFT	DFAIL	FMAXYC	FMAXXT	FMAXYT	YLOCK
Type	F	F	F	F	F	F	F	F
Default	0	0	0.5 × STIFFV	1.0e20	FMAX	FMAX	FMAX	0.0

VARIABLE

DESCRIPTION

MID	Material identification. A unique number or label not exceeding 8 characters must be specified.
RO	Mass density.
A	Nondimensional variable - see below
GAMMA	Nondimensional variable - see below
BETA	Nondimensional variable - see below
DISPY	Yield displacement (length units - must be > 0.0)
STIFFV	Vertical stiffness (force/length units)

VARIABLE	DESCRIPTION
ITYPE	Type: EQ.0: sliding (spherical or cylindrical) EQ.1: elastomeric EQ.2: sliding (two perpendicular curved beams)
PRELOAD	Vertical preload not explicitly modeled (force units)
DAMP	Damping ratio (nondimensional)
MX1, MX2	Moment factor at ends 1 and 2 in local X-direction
MY1, MY2	Moment factor at ends 1 and 2 in local Y-direction
FMAX	Maximum friction coefficient (dynamic)
DELFC	Difference between maximum friction and static friction coefficient
AFRIC	Velocity multiplier in sliding friction equation (time/length units)
RADX	Radius for sliding in local X direction
RADY	Radius for sliding in local Y direction
RADB	Radius of retaining ring
STIFFL	Stiffness for lateral contact against the retaining ring
STIFFTS	Stiffness for tensile vertical response (sliding isolator - default = 0)
FORCEY	Yield force. Used for elastomeric type (ITYPE = 1). Leave blank for sliding type (0, and 2).
ALPHA	Ratio of postyielding stiffness to preyielding stiffness. Used for elastomeric type (ITYPE = 1). Leave blank for sliding type (0, and 2).
STIFFT	Stiffness for tensile vertical response (elastomeric isolator). Used for elastomeric type (ITYPE = 1). Leave blank for sliding type (0, and 2).
DFAIL	Lateral displacement at which the isolator fails. Used for elastomeric type (ITYPE = 1). Leave blank for sliding type (0, and 2).
FMAXYC	Max friction coefficient (dynamic) for local Y-axis (compression). Used for ITYPE = 2. Leave blank for ITYPE = 0 or 1.

VARIABLE	DESCRIPTION
FMAXXT	Max friction coefficient (dynamic) for local X-axis (tension). Used for ITYPE = 2. Leave blank for ITYPE = 0 or 1.
FMAXYT	Max friction coefficient (dynamic) for local Y-axis (tension). Used for ITYPE = 2. Leave blank for ITYPE = 0 or 1.
YLOCK	Stiffness locking the local Y-displacement (optional -single-axis sliding). Used for ITYPE = 2. Leave blank for ITYPE = 0 or 1.

Remarks:

The horizontal behavior of both types is governed by plastic history variables Z_x , Z_y that evolve according to equations given in the reference; A , γ and β and the yield displacement are the input parameters for this. The intention is to provide smooth build-up, rotation and reversal of forces in response to bidirectional displacement histories in the horizontal plane. The theoretical model has been correlated to experiments on seismic isolators.

The RADX, RADY inputs for the sliding isolator are optional. If left blank, the sliding surface is assumed to be flat. A cylindrical surface is obtained by defining either RADX or RADY; a spherical surface can be defined by setting $RADX = RADY$. The effect of the curved surface is to add a restoring force proportional to the horizontal displacement from the center. As seen in elevation, the top of the isolator will follow a curved trajectory, lifting as it displaces away from the center.

The vertical behavior for all types is linear elastic, but with different stiffnesses for tension and compression. By default, the tensile stiffness is zero for the sliding types.

The vertical behavior for the elastomeric type is linear elastic; in the case of uplift, the tensile stiffness will be different to the compressive stiffness. For the sliding type, compression is treated as linear elastic but no tension can be carried.

Vertical preload can be modeled either explicitly (for example, by defining gravity), or by using the PRELOAD input. PRELOAD does not lead to any application of vertical force to the model. It is added to the compression in the element before calculating the friction force and tensile/compressive vertical behavior.

ITYPE = 0 is used to model a single (spherical) pendulum bearing. Triple pendulum bearings can be modelled using three of these elements in series, following the method described by Fenz and Constantinou 2008. The input properties for the three elements (given by \bar{R}_{eff1} , $\bar{\mu}_1$, \bar{d}_1 , \bar{a}_1 , etc) are calculated from the properties of the actual triple bearing (given by R_{eff1} , μ_1 , d_1 , a_1 , etc) as follows:

ITYPE = 2 is intended to model uplift-prevention sliding isolators that consist of two perpendicular curved beams joined by a connector that can slide in slots on both beams. The beams are aligned in the local X and Y axes respectively. The vertical displacement is the sum of the displacements induced by the respective curvatures and slider displacements along the two beams. Single-axis sliding is obtained by using YLOCK to lock the local-Y displacement. To resist uplift, STIFFTS must be defined (recommended value: same as STIFFV). This isolator type allows different friction coefficients on each beam, and different values in tension and compression. The total friction, taking into account sliding velocity and the friction history functions, is first calculated using FMAX and then scaled by FMAXXT/FMAX etc as appropriate. For this reason, FMAX should not be zero.

DAMP is the fraction of critical damping for free vertical vibration of the isolator, based on the mass of the isolator (including any attached lumped masses) and its vertical stiffness. The viscosity is reduced automatically if it would otherwise infringe numerical stability. Damping is generally recommended: oscillations in the vertical force would have a direct effect on friction forces in sliding isolators; for isolators with curved surfaces, vertical oscillations can be excited as the isolator slides up and down the curved surface. It may occasionally be necessary to increase DAMP if these oscillations become significant.

This element has no rotational stiffness - a pin joint is assumed. However, if required, moments can be generated according to the vertical load multiplied by the lateral displacement of the isolator. The moment about the local X-axis (i.e. the moment that is dependent on lateral displacement in the local Y-direction) is reacted on nodes 1 and 2 of the element in the proportions MX1 and MX2 respectively. Similarly, moments about the local Y-axis are reacted in the proportions MY1, MY2. These inputs effectively determine the location of the pin joint.

For example, a pin at the base of the column could be modeled by setting $MX1 = MY1 = 1.0$, $MX2 = MY2 = 0.0$ and ensuring that node 1 is on the foundation, node 2 at the base of the column - then all the moment is transferred to the foundation. For the same model, $MX1 = MY1 = 0.0$, $MX2 = MY2 = 1.0$ would imply a pin at the top of the foundation - all the moment is transferred to the column. Some isolator designs have the pin at the bottom for moments about one horizontal axis, and at the top for the other axis - these can be modeled by setting $MX1 = MY2 = 1.0$, $MX2 = MY1 = 0.0$. It is expected that all $MX1,2$, etc lie between 0 and 1, and that $MX1+MX2 = 1.0$ (or both can be zero) - e.g. $MX1 = MX2 = 0.5$ is permitted - but no error checks are performed to ensure this; similarly for $MY1 + MY2$.

Density should be set to a reasonable value, say 2000 to 8000 kg/m³. The element mass will be calculated as density x volume (volume is entered on *SECTION_BEAM).

Note on values for *SECTION_BEAM:

1. Set ELFORM to 6 (discrete beam)
2. VOL (the element volume) might typically be set to 0.1m³

3. INER needs to be non-zero (say 1.0) but the value has no effect on the solution since the element has no rotational stiffness.
4. CID can be left blank if the isolator is aligned in the global coordinate system, otherwise a coordinate system should be referenced.
5. By default, the isolator will be assumed to rotate with the average rotation of its two nodes. If the base of the column rotates slightly the isolator will no longer be perfectly horizontal: this can cause unexpected vertical displacements coupled with the horizontal motion. To avoid this, rotation of the local axes of the isolator can be eliminated by setting RRCON, SRCON and TRCON to 1.0. This does not introduce any rotational restraint to the model, it only prevents the orientation of the isolator from changing as the model deforms.
6. All other parameters on *SECTION_BEAM can be left blank.

Post-processing note: as with other discrete beam material models, the force described in post-processors as “Axial” is really the force in the local X-direction; “Y-Shear” is really the force in the local Y-direction; and “Z-Shear” is really the force in the local Z-direction.

***MAT_JOINTED_ROCK**

This is Material Type 198. Joints (planes of weakness) are assumed to exist throughout the material at a spacing small enough to be considered ubiquitous. The planes are assumed to lie at constant orientations defined on this material card. Up to three planes can be defined for each material. See *MAT_MOHR_COULOMB (*MAT_173) for a preferred alternative to this material model.

Card 1	1	2	3	4	5	6	7	8
Variable	MID	RO	GMOD	RNU	RKF	PHI	CVAL	PSI
Type	A8	F	F	F	F	F	F	F
Default					1.0			0.0

Card 2	1	2	3	4	5	6	7	8
Variable	STR_LIM	NPLANES	ELASTIC	LCCPDR	LCCPT	LCCJDR	LCCJT	LCSFAC
Type	F	I	I	I	I	I	I	I
Default	0.005	0	0	0	0	0	0	0

Card 3	1	2	3	4	5	6	7	8
Variable	GMODDP	PHIDP	CVALDP	PSIDP	GMODGR	PHIGR	CVALGR	PSIGR
Type	F	F	F	F	F	F	F	F
Default	0.0	0.0	0.0	0.0	0.0	0.0	0.0	0.0

Repeat Card 4 for each plane (maximum 3 planes):

Card 4	1	2	3	4	5	6	7	8
Variable	DIP	STRIKE	CPLANE	FRPLANE	TPLANE	SHRMAX	LOCAL	
Type	F	F	F	F	F	F	F	
Default	0.0	0.0	0.0	0.0	0.0	1.e20	0.0	

VARIABLE**DESCRIPTION**

MID	Material identification. A unique number or label not exceeding 8 characters must be specified.
RO	Mass density
GMOD	Elastic shear modulus
RNU	Poisson's ratio
RKF	Failure surface shape parameter
PHI	Angle of friction (radians)
CVAL	Cohesion value
PSI	Dilation angle (radians)
STR_LIM	Minimum shear strength of material is given by STR_LIM*CVAL
NPLANES	Number of joint planes (maximum 3)
ELASTIC	Flag = 1 for elastic behavior only
LCCPDR	Load curve for extra cohesion for parent material (dynamic relaxation)
LCCPT	Load curve for extra cohesion for parent material (transient)
LCCJDR	Load curve for extra cohesion for joints (dynamic relaxation)
LCCJT	Load curve for extra cohesion for joints (transient)
LCSFAC	Load curve giving factor on strength vs time

VARIABLE	DESCRIPTION
GMODDP	Depth at which shear modulus (GMOD) is correct
PHIDP	Depth at which angle of friction (PHI) is correct
CVALDP	Depth at which cohesion value (CVAL) is correct
PSIDP	Depth at which dilation angle (PSI) is correct
GMODGR	Gradient at which shear modulus (GMOD) increases with depth
PHIGR	Gradient at which friction angle (PHI) increases with depth
CVALGR	Gradient at which cohesion value (CVAL) increases with depth
PSIGR	Gradient at which dilation angle (PSI) increases with depth
DIP	Angle of the plane in degrees below the horizontal
DIPANG	Plan view angle (degrees) of downhill vector drawn on the plane
CPLANE	Cohesion for shear behavior on plane
PHPLANE	Friction angle for shear behavior on plane (degrees)
TPLANE	Tensile strength across plane (generally zero or very small)
SHRMAX	Max shear stress on plane (upper limit, independent of compression)
LOCAL	EQ.0: DIP and DIPANG are with respect to the global axes

Remarks:

1. The joint plane orientations are defined by the angle of a “downhill vector” drawn on the plane, i.e. the vector is oriented within the plane to obtain the maximum possible downhill angle. DIP is the angle of this line below the horizontal. DIPANG is the plan-view angle of the line (pointing down hill) measured clockwise from the global Y-axis about the global Z-axis.
2. The joint planes rotate with the rigid body motion of the elements, irrespective of whether their initial definitions are in the global or local axis system.
3. The full facilities of the modified Drucker Prager model for the matrix material can be used – see description of Material type 193. Alternatively, to speed up the calculation, the ELASTIC flag can be set to 1, in which case the yield surface will not be

considered and only RO, GMOD, RNU, GMODDP, GMODGR and the joint planes will be used.

4. This material type requires that the model is oriented such that the z-axis is defined in the upward direction. The key parameters are defined such that may vary with depth (i.e. the z-axis)
5. The shape factor for a typical soil would be 0.8, but should not be pushed further than 0.75.
6. If STR_LIM is set to less than 0.005, the value is reset to 0.005.
7. A correction has been introduced into the Drucker Prager model, such that the yield surface never infringes the Mohr-Coulomb criterion. This means that the model does not give the same results as a "pure" Drucker Prager model.
8. The load curves LCCPDR, LCCPT, LCCJDR, LCCJT allow additional cohesion to be specified as a function of time. The cohesion is additional to that specified in the material parameters. This is intended for use during the initial stages of an analysis to allow application of gravity or other loads without cracking or yielding, and for the cracking or yielding then to be introduced in a controlled manner. This is done by specifying extra cohesion that exceeds the expected stresses initially, then declining to zero. If no curves are specified, no extra cohesion is applied.
9. The load curve for factor on strength applies simultaneously to the cohesion and tan (friction angle) of parent material and all joints. This feature is intended for reducing the strength of the material gradually, to explore factors of safety. If no curve is present, a constant factor of 1 is assumed. Values much greater than 1.0 may cause problems with stability.
10. Extra variables for plotting. By setting NEIPH on *DATABASE_EXTENT_BINARY to 15, the following variables can be plotted in D3PLOT and T/HIS:
 - Extra Variable 1: mobilized strength fraction for base material
 - Extra Variable 2: rk0 for base material
 - Extra Variable 3: rlamda for base material
 - Extra Variable 4: crack opening strain for plane 1
 - Extra Variable 5: crack opening strain for plane 2
 - Extra Variable 6: crack opening strain for plane 3
 - Extra Variable 7: crack accumulated shear strain for plane 1
 - Extra Variable 8: crack accumulated shear strain for plane 2
 - Extra Variable 9: crack accumulated shear strain for plane 3
 - Extra Variable 10: current shear utilization for plane 1
 - Extra Variable 11: current shear utilization for plane 2
 - Extra Variable 12: current shear utilization for plane 3
 - Extra Variable 13: maximum shear utilization to date for plane 1
 - Extra Variable 14: maximum shear utilization to date for plane 2
 - Extra Variable 15: maximum shear utilization to date for plane 3

11. Joint planes would generally be defined in the global axis system if they are taken from survey data. However, the material model can also be used to represent masonry, in which case the weak planes represent the cement and lie parallel to the local element axes.

***MAT_STEEL_EC3**

This is Material Type 202. Tables and formulae from Eurocode 3 are used to derive the mechanical properties and their variation with temperature, although these can be overridden by user-defined curves. It is currently available only for Hughes-Liu beam elements. Warning, this material is still under development and should be used with caution.

Card 1	1	2	3	4	5	6	7	8
Variable	MID	RO	E	PR	SIGY			
Type	A8	F	F	F	F			
Default	none	none	none	none	none			

Card 2	1	2	3	4	5	6	7	8
Variable	LC_E	LC_PR	LC_AL	TBL_SS	LC_FS			
Type	F	F	F	F	F			
Default	none	none	none	none	none			

Card 3 *must* be included but left blank.

Card 3	1	2	3	4	5	6	7	8
Variable								
Type								
Default								

VARIABLE**DESCRIPTION**

MID	Material identification. A unique number or label not exceeding 8 characters must be specified.
RO	Mass density.

VARIABLE	DESCRIPTION
E	Young's modulus – a reasonable value must be provided even if LC_E is also input. See notes.
PR	Poisson's ratio.
SIGY	Initial yield stress, σ_{y0} .
LC_E	Optional Loadcurve ID: Young's Modulus vs Temperature (overrides E and factors from EC3).
LC_PR	Optional Loadcurve ID: Poisson's Ratio vs Temperature (overrides PR).
LC_AL	Optional Loadcurve ID: alpha vs temperature (over-rides thermal expansion data from EC3).
TBL_SS	Optional Table ID containing stress-strain curves at different temperatures (overrides curves from EC3).
LC_FS	Optional Loadcurve ID: failure strain vs temperature.

Remarks:

1. This material model is intended for modelling structural steel in fires.
2. By default, only E, PR and SIGY have to be defined. Eurocode 3 (EC3) Section 3.2 specifies the stress-strain behaviour of carbon steels at temperatures between 20C and 1200C. The stress-strain curves given in EC3 are scaled within the material model such that the maximum stress at low temperatures is SIGY, see graph below.
3. By default, the Young's Modulus E will be scaled by a factor which is a function of temperature as specified in EC3. The factor is 1.0 at low temperature.
4. By default, the thermal expansion coefficient as a function of temperature will be as specified in EC3 Section 3.4.1.1.
5. LC_E, LC_PR and LC_AL are optional; they should have temperature on the x-axis and the material property on the y-axis, with the points in order of increasing temperature. If present (i.e. non-zero) they over-ride E, PR, and the relationships from EC3. However, a reasonable value for E should always be included, since these values will be used for purposes such as contact stiffness calculation.
6. TBL_SS is optional. If present, TBL_SS must be the ID of a *DEFINE_TABLE. TBL_SS overrides SIGY and the stress-strain relationships from EC3. The field VALUE on the *DEFINE_TABLE should contain the temperature at which each stress-

strain curve is applicable; the temperatures should be in ascending order. The curves that follow the temperature values have (true) plastic strain on the x-axis, (true) yield stress on the y-axis as per other LS-DYNA elasto-plastic material models. As with all instances of *DEFINE TABLE, the curves containing the stress-strain data must immediately follow the *DEFINE_TABLE input data and must be in the correct order (i.e. the same order as the temperatures).

- 7. Temperature can be defined by any of the *LOAD_THERMAL methods. The temperature does not have to start at zero: the initial temperature will be taken as a reference temperature for each element, so non-zero initial temperatures will not cause thermal shock effects.

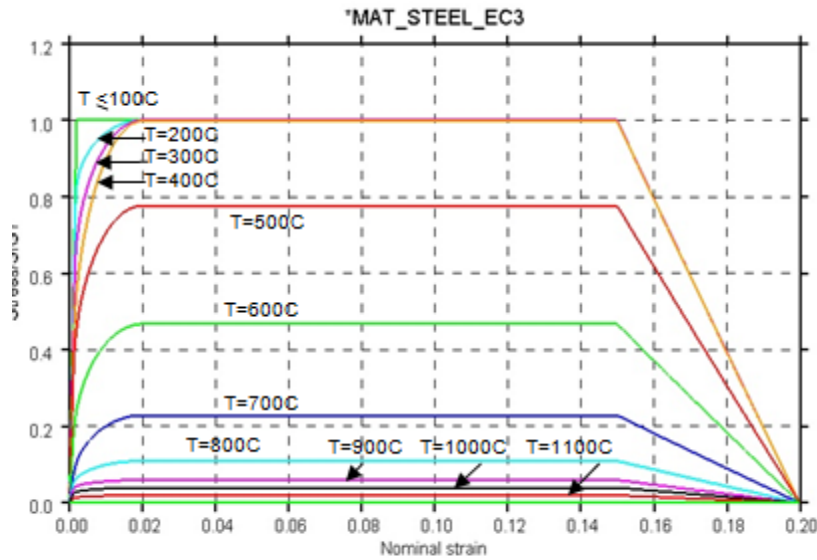

Figure 2-107.

***MAT_BOLT_BEAM**

This is Material Type 208 for use with beam elements using ELFORM = 6 (Discrete Beam). The beam elements must have nonzero initial length so that the directions in which tension and compression act can be distinguished. See notes below.

Card 1	1	2	3	4	5	6	7	8
Variable	MID	RO	KAX	KSHR	blank	blank	FPRE	TRAMP
Type	A8	F	F	F			F	F
Default	none	none	0.0	0.0			0.0	0.0

Card 2	1	2	3	4	5	6	7	8
Variable	LCAX	LCSHR	FRIC	CLEAR	DAFAIL	DRFAIL	DAMAG	TOPRE
Type	I	I	F	F	F	F	F	F
Default	0	0	0.0	0.0	1.E20	1.E20	0.1	0.0

Card 3 *must* be included but left blank.

Card 3	1	2	3	4	5	6	7	8
Variable								
Type								
Default								

VARIABLE**DESCRIPTION**

MID	Material identification. A unique number or label not exceeding 8 characters must be specified.
RO	Mass density.

VARIABLE	DESCRIPTION
G	Shear modulus.
KAX	Axial elastic stiffness (Force/Length units).
KSHR	Shear elastic stiffness (Force/Length units).
FPRE	Preload force.
TRAMP	Time duration during which preload is ramped up.
LCAX	Load curve giving axial load versus displacement (x-axis = displacement (length units), y-axis = force).
LCSHR	Load curve ID or table ID giving lateral load versus displacement (x-axis - displacement (length units), y-axis - force). In the table case, each curve in the table represents lateral load versus displacement at a given (current) axial load, i.e. the values in the table are axial forces.
FRIC	Friction coefficient resisting sliding of bolt head/nut (non-dimensional).
CLEAR	Radial clearance (gap between bolt shank and the inner diameter of the hole) (length units).
DAFAIL	Axial tensile displacement to failure (length units).
DRFAIL	Radial displacement to failure (excludes clearance).
DAMAG	Fraction of above displacements between initiation & completion of failure.
TOPRE	Time at which preload application begins.

Remarks:

The element represents a bolted joint. The axial response is tensile-only. Instead of generating a compressive axial load, it is assumed that a gap would develop between the bolt head (or nut) and the surface of the plate. Contact between the bolted surfaces must be modelled separately, e.g. using *CONTACT.

Curves LCAX, LCSHR give yield force versus plastic displacement for the axial and shear directions. The force increments are calculated from the elastic stiffnesses, subject to the yield force limits given by the curves.

CLEAR allows the bolt to slide in shear, resisted by friction between bolt head/nut and the surfaces of the plates, from the initial position at the centre of the hole. CLEAR is the total sliding shear displacement before contact occurs between the bolt shank and the inside surface of the hole. Sliding shear displacement is not included in the displacement used for LCSHR; LCSHR is intended to represent the behaviour after the bolt shank contacts the edge of the hole.

Output: beam "axial" or "X" force is the axial force in the beam. "shear-Y" and "shear-Z" are the shear forces.

Other output is written to the d3plot and d3thdt files in the places where post-processors expect to find the stress and strain at the first two integration points for integrated beams.

<u>Post-Processing data component</u>	<u>Actual meaning</u>
Int. Pt 1, Axial Stress	Change of length
Int Pt 1, XY Shear stress	Sliding shear displacement in local Y
Int Pt 1, ZX Shear stress	Sliding shear displacement in local Z
Int Pt 1, Plastic strain	Resultant shear sliding displacement
Int Pt 1, Axial strain	Axial plastic displacement
Int. Pt 2, Axial Stress	Shear plastic displacement excluding sliding
Int Pt 2, XY Shear stress	-
Int Pt 2, ZX Shear stress	-
Int Pt 2, Plastic strain	-
Int Pt 2, Axial strain	-

***MAT_CODAM2**

This is material type 219. This material model is the second generation of the UBC Composite Damage Model (CODAM2) for brick, shell, and thick shell elements developed at The University of British Columbia. The model is a sub-laminate-based continuum damage mechanics model for fiber reinforced composite laminates made up of transversely isotropic layers. The material model includes an optional non-local averaging and element erosion.

Card 1	1	2	3	4	5	6	7	8
Variable	MID	RO	EA	EB		PRBA		PRCB
Type	A8	F	F	F		F		F
Default	none	none	none	none		none		none

Card 2	1	2	3	4	5	6	7	8
Variable	GAB			NLAYER	R1	R2	NFREQ	
Type	F			I	F	F	I	
Default	none			0	0.0	0.0	0	

Card 3	1	2	3	4	5	6	7	8
Variable	XP	YP	ZP	A1	A2	A3	AOPT	
Type	F	F	F	F	F	F	I	
Default	0.0	0.0	0.0	0.0	0.0	0.0	0	

Card 4	1	2	3	4	5	6	7	8
Variable	V1	V2	V3	D1	D2	D3	BETA	MACF
Type	F	F	F	F	F	F	F	I
Default	0.0	0.0	0.0	0.0	0.0	0.0	0.0	0

Angle Cards. For each of the NLayer layers specify on angle. Include as many cards as needed to set NLayer values.

Card 5	1	2	3	4	5	6	7	8
Variable	ANGLE1	ANGLE2	ANGLE3	ANGLE4	ANGLE5	ANGLE6	ANGLE7	ANGLE8
Type	F	F	F	F	F	F	F	F
Default	none	none	none	none	none	none	none	none

Card 6	1	2	3	4	5	6	7	8
Variable	IMATT	IFIBT	ILOCT	IDELT	SMATT	SFIBT	SLOCT	SDELT
Type	F	F	F	F	F	F	F	F
Default	none	none	none	none	none	none	none	none

Card 7	1	2	3	4	5	6	7	8
Variable	IMATC	IFIBC	ILOCC	IDELC	SMATC	SFIBC	SLOCC	SDELC
Type	F	F	F	F	F	F	F	F
Default	none	none	none	none	none	none	none	none

Card 8	1	2	3	4	5	6	7	8
Variable	ERODE	ERPAR1	ERPAR2	RESIDS				
Type	I	F	F	F				
Default	0	none	none	0				

VARIABLE**DESCRIPTION**

MID	Material identification. A unique number or label not exceeding 8 characters must be specified.
RO	Mass density
EA	E_a , Young's modulus in a-direction = Modulus along the direction of fibers.
EB	E_b , Young's modulus in b-direction = Modulus transverse to fibers.
PRBA	ν_{ba} , Poisson's ratio, ba (minor in-plane Poisson's ratio).
PRCB	ν_{cb} , Poisson's ratio, cb (Poisson's ratio in the plane of isotropy).
GAB	G_{ab} , Shear modulus, ab (in-plane shear modulus).
NLAYER	Number of layers in the sub-laminate excluding symmetry. As an example, in a $[0/45/-45/90]_{3s}$, NLAYER = 4.
R1	Non-local averaging radius.
R2	Currently not used.
NFREQ	Number of time steps between update of neighbor list for nonlocal smoothing. EQ.0: Do only one search at the start of the calculation
XP, YP, ZP	Coordinates of point p for AOPT = 1 and 4.
A1, A2, A3	Components of vector a for AOPT = 2.
AOPT	Material axes option (see MAT_OPTIONTROPIC_ELASTIC for a more complete description): EQ.0.0: locally orthotropic with material axes determined by ele-

VARIABLE	DESCRIPTION
	<p>ment nodes 1, 2, and 4, as with *DEFINE_COORDINATE_NODES.</p> <p>EQ.1.0: locally orthotropic with material axes determined by a point in space and the global location of the element center; this is the a-direction. This option is for solid elements only.</p> <p>EQ.2.0: globally orthotropic with material axes determined by vectors defined below, as with *DEFINE_COORDINATE_VECTOR.</p> <p>EQ.3.0: locally orthotropic material axes determined by rotating the material axes about the element normal by an angle, BETA, from a line in the plane of the element defined by the cross product of the vector \mathbf{v} with the element normal.</p> <p>EQ.4.0: locally orthotropic in cylindrical coordinate system with the material axes determined by a vector \mathbf{v}, and an originating point, p, which define the centerline axis. This option is for solid elements only.</p> <p>LT.0.0: the absolute value of AOPT is a coordinate system ID number (CID on *DEFINE_COORDINATE_NODES, *DEFINE_COORDINATE_SYSTEM or *DEFINE_COORDINATE_VECTOR).</p>
V1, V2, V3	Components of vector \mathbf{v} for AOPT = 3 and 4.
D1, D2, D3	Components of vector \mathbf{d} for AOPT = 2.
BETA	Material angle in degrees for AOPT = 3, may be overridden on the element card, see *ELEMENT_SHELL_BETA or *ELEMENT_SOLID_ORTHO.
MACF	<p>Material axes change flag for brick elements:</p> <p>EQ.1: No change, default,</p> <p>EQ.2: switch material axes a and b,</p> <p>EQ.3: switch material axes a and c,</p> <p>EQ.4: switch material axes b and c.</p>
ANGLE $_i$	Rotation angle in degrees of layers with respect to the material axes. Input one for each layer.

VARIABLE	DESCRIPTION
IMATT	Initiation strain for damage in matrix (transverse) under tensile condition.
IFIBT	Initiation strain for damage in the fiber (longitudinal) under tensile condition.
ILOCT	Initiation strain for the anti-locking mechanism. This parameter should be equal to the saturation strain for the fiber damage mechanism under tensile condition.
IDELT	Not working in the current version. Can be used for visualization purpose only.
SMATT	Saturation strain for damage in matrix (transverse) under tensile condition.
SFIBT	Saturation strain for damage in the fiber (longitudinal) under tensile condition.
SLOCT	Saturation strain for the anti-locking mechanism under tensile condition. The recommended value for this parameter is (ILOCT+0.02).
SDELT	Not working in the current version. Can be used for visualization purpose only.
IMATC	Initiation strain for damage in matrix (transverse) under compressive condition.
IFIBC	Initiation strain for damage in the fiber (longitudinal) under compressive condition.
ILOCC	Initiation strain for the anti-locking mechanism. This parameter should be equal to the saturation strain for the fiber damage mechanism under compressive condition.
IDELC	Initiation strain for delamination. Not working in the current version. Can be used for visualization purpose only.
SMATC	Saturation strain for damage in matrix (transverse) under compressive condition.
SFIBC	Saturation strain for damage in the fiber (longitudinal) under compressive condition.

VARIABLE	DESCRIPTION
SLOCC	Saturation strain for the anti-locking mechanism under compressive condition. The recommended value for this parameter is (ILOCC+0.02).
SDELCL	Delamination strain. Not working in the current version. Can be used for visualization purpose only.
ERODE	Erosion Flag (see remarks) EQ.0: Erosion is turned off. EQ.1: Non-local strain based erosion criterion. EQ.2: Local strain based erosion criterion. EQ.3: Use both ERODE = 1 and ERODE = 2 criteria.
ERPAR1	The erosion parameter #1 used in ERODE types 1 and 3. ERPAR1 >= 1.0 and the recommended value is ERPAR1 = 1.2.
ERPAR2	The erosion parameter #2 used in ERODE types 2 and 3. The recommended value is five times SLOC defined in cards 7 and 8.
RESIDS	Residual strength for layer damage

Model Description:

CODAM2 is developed for modeling the nonlinear, progressive damage behavior of laminated fiber-reinforced plastic materials. The model is based on the work by (Forghani, 2011; Forghani et al. 2011a; Forghani et al. 2011b) and is an extension of the original model, CODAM (Williams et al. 2003).

Briefly, the model uses a continuum damage mechanics approach and the following assumptions have been made in its development:

1. The material is an orthotropic medium consisting of a number of repeating units through the thickness of the laminate, called sub-laminates. e.g. . [0/±45/90] in a [0/±45/90]_{8S} laminate.
2. The nonlinear behavior of the composite sub-laminate is only caused by damage evolution. Nonlinear elastic or plastic deformations are not considered.

Formulation:

The in-plane secant stiffness of the damaged laminate is represented as the summation of the effective contributions of the layers in the laminate as shown.

$$\mathbf{A}^d = \sum \mathbf{T}_k^T \mathbf{Q}_k^d \mathbf{T}_k t_k$$

where T_k is the transformation matrix for the strain vector, and Q_k^d is the in-plane secant stiffness of k^{th} layer in the principal orthotropic plane, and t_k is the thickness of the k^{th} layer of an n -layered laminate.

A physically-based and yet simple approach has been employed here to derive the damaged stiffness matrix. Two reduction coefficients, R_f and R_m , that represent the reduction of stiffness in the longitudinal (fiber) and transverse (matrix) directions have been employed. The shear modulus has also been reduced by the matrix reduction parameter. The major and minor Poisson's ratios have been reduced by R_f and R_m respectively. A sub-laminate-level reduction, R_L , is incorporated to avoid spurious stress locking in the damaged zone. This would lead to an effective reduced stiffness matrix Q_k^d . The reduction coefficients are equal to 1 in the undamaged condition and gradually decrease to 0 for a saturated damage condition.

$$Q_k^d = R_L \begin{bmatrix} \frac{R_f E_1}{1 - R_f R_m \nu_{12} \nu_{21}} & \frac{R_f R_m \nu_{12} E_2}{1 - R_f R_m \nu_{12} \nu_{21}} & 0 \\ R_f R_m \nu_{12} E_2 & R_m E_2 & 0 \\ \frac{R_f R_m \nu_{12} E_2}{1 - R_f R_m \nu_{12} \nu_{21}} & \frac{R_m E_2}{1 - R_f R_m \nu_{12} \nu_{21}} & 0 \\ 0 & 0 & R_m G_{12} \end{bmatrix}_k = Q_k^{dT}$$

where E_1 , E_2 , ν_{12} , ν_{21} , and G_{12} are the elastic constants of the lamina.

Damage Evolution:

In CODAM2, the evolution of damage mechanisms are expressed in terms of equivalent strain parameters. The equivalent strain function that governs the fiber stiffness reduction parameter is written in terms of the longitudinal normal strains by

$$\varepsilon_{f,k}^{\text{eq}} = \varepsilon_{11,k} \quad ; k = 1 \dots n$$

The equivalent strain function that governs the matrix stiffness reduction parameter is written in an interactive form in terms of the transverse and shear components of the local strain.

$$\varepsilon_{m,k}^{\text{eq}} = \text{sign}(\varepsilon_{22,k}) \sqrt{(\varepsilon_{22,k})^2 + \left(\frac{\gamma_{12,k}}{2}\right)^2} \quad ; k = 1 \dots n$$

The sign of the transverse normal strain plays a very important role in the initiation and growth of damage since it indicates the compressive or tensile nature of the transverse stress. Therefore, the equivalent strain for the matrix damage carries the sign of the transverse normal strain.

Evolution of the overall damage mechanism (anti-locking) is written in terms of the maximum principal strains.

$$\varepsilon_L^{\text{eq}} = \max[\text{prn}(\varepsilon)]$$

Within the framework of non-local strain-softening formulations adopted here, all damage modes, be it intra-laminar (i.e. fiber and matrix damage) or overall sub-laminate modes are considered to be a function of the non-local (averaged) equivalent strain defined as:

$$\bar{\varepsilon}_\alpha^{\text{eq}} = \int_{\Omega_x} \varepsilon_\alpha^{\text{eq}}(\mathbf{x}) w_\alpha(\mathbf{X} - \mathbf{x}) d\Omega$$

where the subscript α denotes the mode of damage: fiber ($\alpha = f$) and matrix ($\alpha = m$) damage in each layer, k , within the sub-laminate or associated with the overall sub-laminate, namely, locking ($\alpha = L$). Thus, for a given sub-laminate with n layers, $\varepsilon_\alpha^{\text{eq}}$ and $\bar{\varepsilon}_\alpha^{\text{eq}}$ are vectors of size $2n + 1$. \mathbf{X} represents the position vector of the original point of interest and \mathbf{x} denotes the position vector of all other points (Gauss points) in the averaging zone denoted by Ω . In classical isotropic non-local averaging approach, this zone is taken to be spherical (or circular in 2D) with a radius of r (named R1 in the material input card). The parameter, r , which affects the size of the averaging zone, introduces a length scale into the model that is linked directly to the predicted size of the damage zone. Averaging is done with a bell-shaped weight function, w_α , evaluated by

$$w_\alpha = \left[1 - \left(\frac{d}{r} \right)^2 \right]^2$$

where d is the distance from the integration point of interest to another integration point with the averaging zone.

The damage parameters, ω , are calculated as a function of the corresponding averaged equivalent strains. In CODAM2 the damage parameters are assumed to grow as a hyperbolic function of the damage potential (non-local equivalent strains) such that when used in conjunction with stiffness reduction factors that vary linearly with the damage parameters they result in a linear strain-softening response (or a bilinear stress-strain curve) for each mode of damage

$$\omega_\alpha = \frac{(|\bar{\varepsilon}_\alpha^{\text{eq}}| - \varepsilon_\alpha^i) \varepsilon_\alpha^s}{(\varepsilon_\alpha^s - \varepsilon_\alpha^i) |\bar{\varepsilon}_\alpha^{\text{eq}}|} \quad ; \quad \text{for}(|\bar{\varepsilon}_\alpha^{\text{eq}}| - \varepsilon_\alpha^i) > 0$$

where superscripts i and s denote, respectively, the damage initiation and saturation values of the strain quantities to which they are assigned. The initiation and saturation parameters are defined in material cards #6 and #7. Damage is considered to be a monotonically increasing function of time, t , such that

$$\omega_\alpha = \max[\omega_\alpha^\tau \mid \tau \leq t, \omega_\alpha^t]$$

where ω_α^t is the value of ω_α for the current time (load state), and ω_α^τ represents the state of damage at previous times $\tau \leq t$.

Damage is applied by scaling the layer stress by reduction parameters

$$R_\alpha = 1 - \omega_\alpha$$

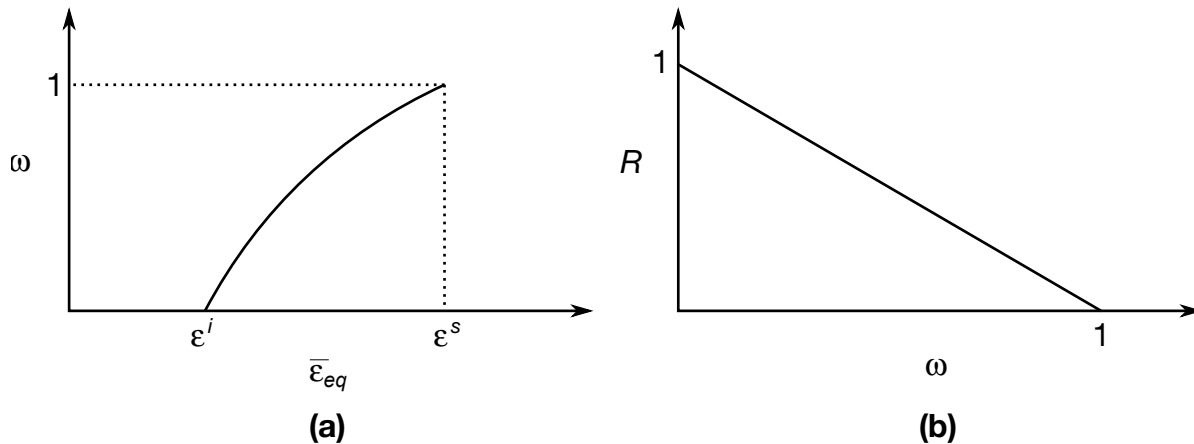

Figure 2-108. illustrations of (a) damage parameter and (b) reduction parameter.

where $\alpha = f$ and $\alpha = m$. The layer stresses are summed and then then scaled by reduction parameter

$$R_L = 1 - \omega_L.$$

Figures [2-108](#) (a) and (b) show the relationship between the damage and reduction parameters

If the parameter RESIDS > 0, damage in the layers is limited such that

$$R_f = \max(\text{RESIDS}, 1 - \omega_f)$$

$$R_m = \max(\text{RESIDS}, 1 - \omega_m)$$

Element Erosion:

When ERODE > 0, an erosion criterion is checked at each integration point. Shell elements and thick shell elements will be deleted when the erosion criterion has been met at all integration points. Brick elements will be deleted when the erosion criterion is met at any of the integration points. For ERODE = 1, the erosion criterion is met when maximum principal strain exceeds either SLOCT × ERPAR1 for elements in tension, or SLOCC × ERPAR1 for elements in compression. Elements are in tension when the magnitude of the first principal strain is greater than the magnitude of the third principal strain and in compression when the third principal strain is larger. When R > 0, the ERODE = 1 criterion is checked using the non-local (averaged) principal strain. For ERODE = 2, the erosion criterion is met when the local (non-averaged) maximum principal strain exceeds ERPAR2. For ERODE = 3, both of these erosion criteria are checked. For visualization purposes, the ratio of the maximum principal strain over the limit is stored in the location of plastic strain which is written by default to the ELOUT and D3PLOT files.

History Variables:

History variables for CODAM2 are enumerated in the following tables. To include them in the D3PLOT database, use NEIPH (bricks) or NEIPS (shells) on *DATABASE_EXTENT_BINARY. For brick elements, add 4 to the variable numbers in the table because the first 6 history variables are reserved.

Damage parameters

VARIABLE #	DESCRIPTION
3	Overall (anti-locking) Damage.
4	Delamination Damage (for visualization only)
5	Fiber damage in the first layer
6	Matrix damage in the first layer
7	Fiber damage in the second layer
8	Matrix damage in the second layer
:	:
$3 + 2 \times \text{NLAYER}$	Fiber damage in the last layer
$4 + 2 \times \text{NLAYER}$	Matrix damage in the last layer

Equivalent Strains used to evaluate damage (averaged if R1 > 0)

VARIABLE #	DESCRIPTION
$5 + 2 \times \text{NLAYER}$	$\varepsilon_R^{\text{eq}}$
$6 + 2 \times \text{NLAYER}$	$\varepsilon_{f,1}^{\text{eq}}$
$7 + 2 \times \text{NLAYER}$	$\varepsilon_{m,1}^{\text{eq}}$
$8 + 2 \times \text{NLAYER}$	$\varepsilon_{f,2}^{\text{eq}}$
$9 + 2 \times \text{NLAYER}$	$\varepsilon_{m,2}^{\text{eq}}$
⋮	⋮
$4 + 4 \times \text{NLAYER}$	$\varepsilon_{f,n}^{\text{eq}}$
$5 + 4 \times \text{NLAYER}$	$\varepsilon_{f,n}^{\text{eq}}$

Total Strain

VARIABLE #	DESCRIPTION
$6 + 4 \times \text{NLAYER}$	ε_x
$7 + 4 \times \text{NLAYER}$	ε_y
$8 + 4 \times \text{NLAYER}$	ε_z
$9 + 4 \times \text{NLAYER}$	γ_{xy}
$10 + 4 \times \text{NLAYER}$	γ_{yz}
$11 + 4 \times \text{NLAYER}$	γ_{zx}

***MAT_DRY_FABRIC**

This is Material Type 214. This material model can be used to model high strength woven fabrics, such as Kevlar® 49, with transverse orthotropic behavior for use in structural systems where high energy absorption is required (Bansal et al., Naik et al., Stahlecker et al.). The major applications of the model are for the materials used in propulsion engine containment system, body armor and personal protections.

Woven dry fabrics are described in terms of two principal material directions, longitudinal warp and transverse fill yarns. The primary failure mode in these materials is the breaking of either transverse or longitudinal yarn. An equivalent continuum formulation is used and an element is designated as having failed when it reaches some critical value for strain in either directions. A linearized approximation to a typical stress-strain curve is shown in [Figure 2-109](#), and to a typical engineering shear stress-strain curve is shown in the figure corresponding to the GAB i field in the variable list. Note that the principal directions are labeled a for the warp and b for the fill, and the direction c is orthogonal to a and b .

The material model is available for membrane elements and it is recommended to use a double precision version of LS-DYNA.

Card 1	1	2	3	4	5	6	7	8
Variable	MID	RO	EA	EB	GAB1	GAB2	GAB3	
Type	A8	F	F	F	F	F	F	

Card 2	1	2	3	4	5	6	7	8
Variable	GBC	GCA	GAMAB1	GAMAB2				
Type	F	F	F	F				

Card 3	1	2	3	4	5	6	7	8
Variable	AOPT		XP	YP	ZP	A1	A2	A3
Type	F		F	F	F	F	F	F

Card 4	1	2	3	4	5	6	7	8
Variable	V1	V2	V3	D1	D2	D3	BETA	
Type	F	F	F	F	F	F	F	

Card 5	1	2	3	4	5	6	7	8
Variable	EACRF	EBCRF	EACRP	EBCRP				
Type	F	F	F	F				
Remarks	2	2						

Card 6	1	2	3	4	5	6	7	8
Variable	EASF	EBSF	EUNLF	ECOMF	EAMAX	EBMAX	SIGPOST	
Type	F	F	F	F	F	F	F	
Remarks	2	2	2	2				

Card 7	1	2	3	4	5	6	7	8
Variable	CCE	PCE	CSE	PSE	DFAC	EMAX	EAFAIL	EBFAIL
Type	F	F	F	F	F	F	F	F
Remarks	1	1	1	1	3	4	4	4

VARIABLE

DESCRIPTION

MID Material identification. A unique number or label not exceeding 8 characters must be specified.

RO Continuum equivalent mass density.

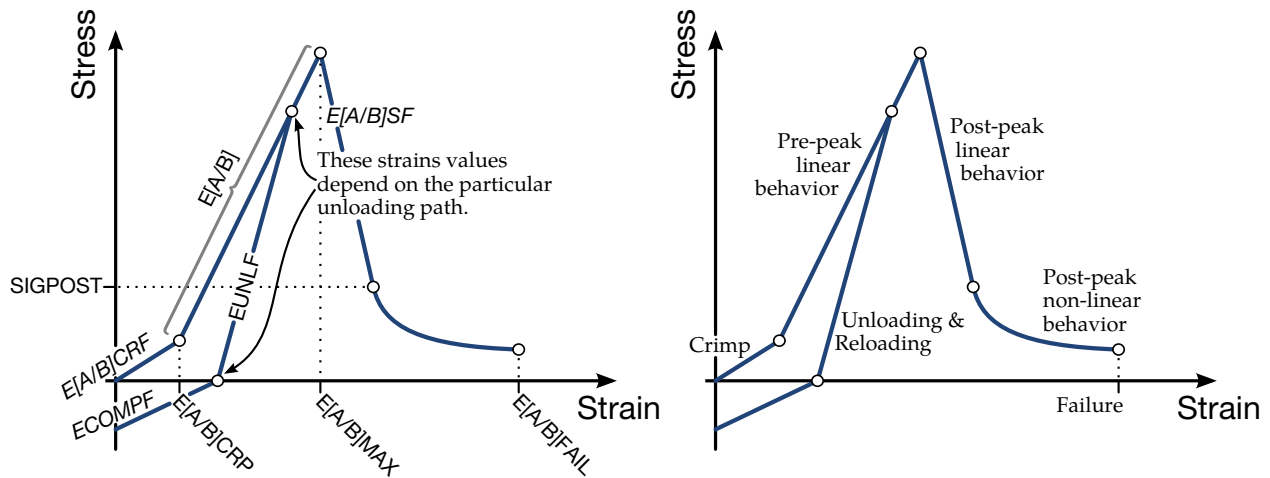

Figure 2-109. Stress – Strain curve for *MAT_DRY_FABRIC. This curve models the force-response in the longitudinal and transverse directions.

VARIABLE	DESCRIPTION
EA	Modulus of elasticity in the longitudinal (warp) direction, which corresponds to the slope of segment AB in Figure 2-109 .
EB	Modulus of elasticity in the transverse (fill) direction, which corresponds to the slope of segment of AB Figure 2-109 .
GABi / GAMABi	Shear stress-strain behavior is modeled as piecewise linear in three segments. <i>See the figure to the right.</i> The shear moduli GABi correspond to the slope of the i th segment. The start and end points for the segments are specified in the GAMAB[1-2] fields. <div data-bbox="906 1108 1421 1507" data-label="Figure"> </div>
GBC	G_{bc} , Shear modulus in <i>bc</i> direction.
GCA	G_{ca} , Shear modulus in <i>ca</i> direction.
AOPT	Material axes option. See *MAT_OPTIONTROPIC_ELASTIC for a more complete description:

EQ.0.0: locally orthotropic with material axes determined by element nodes 1, 2, and 4, as with *DEFINE_COORDINATE_NODES, and then rotated about the element normal by an angle BETA.

VARIABLE	DESCRIPTION
	EQ.2.0: globally orthotropic with material axes determined by vectors defined below, as with *DEFINE_COORDINATE_VECTOR.
	EQ.3.0: locally orthotropic material axes determined by rotating the material axes about the element normal by an angle, BETA, from a line in the plane of the element defined by the cross product of the vector \mathbf{v} with the element normal.
	LT.0.0: the absolute value of AOPT is a coordinate system ID number (CID on *DEFINE_COORDINATE_NODES, *DEFINE_COORDINATE_SYSTEM or *DEFINE_COORDINATE_VECTOR). Available in R3 version of 971 and later.
XP, YP, ZP	Components of vector \mathbf{x} .
A1, A2, A3	Components of vector \mathbf{a} for AOPT = 2.
V1, V2, V3	Components of vector \mathbf{v} for AOPT = 3.
D1, D2, D3	Components of vector \mathbf{d} for AOPT = 2.
BETA	Material angle in degrees for AOPT = 0 and 3, may be overridden on the element card, see *ELEMENT_SHELL_BETA.
EACRF	Factor for crimp region modulus of elasticity in longitudinal direction (See Figure 2-109):
	$E_{a,crimp} = E_{a,crimpfac}E, \quad E_{a,crimpfac} = EACRF$
EBCRF	Factor for crimp region modulus of elasticity in transverse direction (See Figure 2-109):
	$E_{b,crimp} = E_{b,crimpfac}E, \quad E_{b,crimpfac} = EBCRF$
EACRP	Crimp strain in longitudinal direction (See Figure 2-109):
	$\varepsilon_{a,crimp}$
EBCRP	Crimp strain in transverse direction (See Figure 2-109):
	$\varepsilon_{b,crimp}$

VARIABLE	DESCRIPTION
EASF	Factor for post-peak region modulus of elasticity in longitudinal direction (see Figure 2-109): $E_{a,soft} = E_{a,softfac}E, \quad E_{a,softfac} = \text{EASF}$
EBSF	Factor for post-peak region modulus of elasticity in transverse direction (see Figure 2-109): $E_{b,soft} = E_{b,softfac}E, \quad E_{b,softfac} = \text{EBSF}$
EUNLF	Factor for unloading modulus of elasticity (See Figure 2-109): $E_{unload} = E_{unloadfac}E, \quad E_{unloadfac} = \text{EUNLF}$
ECOMPF	Factor for compression zone modulus of elasticity (see Figure 2-109): $E_{comp} = E_{compfac}E, \quad E_{compfac} = \text{ECOMPF}$
EAMAX	Strain at peak stress in longitudinal direction (see Figure 2-109): $\epsilon_{a,max}$
EBMAX	Strain at peak stress in transverse direction (see Figure 2-109): $\epsilon_{b,max}$
SIGPOST	Stress value in post-peak region at which nonlinear behavior begins (see Figure 2-109): σ_{post}
CCE	Strain rate parameter C , Cowper-Symonds factor for modulus. If zero, rate effects are not considered.
PCE	Strain rate parameter P , Cowper-Symonds factor for modulus. If zero, rate effects are not considered.
CSE	Strain rate parameter C , Cowper-Symonds factor for stress to peak / failure. If zero, rate effects are not considered.
PSE	Strain rate parameter P , Cowper-Symonds factor for stress to peak / failure. If zero, rate effects are not considered.
DFAC	Damage factor: d_{fac}

VARIABLE	DESCRIPTION
EMAX	Erosion strain of element: ϵ_{\max}
EAFAIL	Erosion strain in longitudinal direction (see Figure 2-109): $\epsilon_{a,\text{fail}}$
EBFAIL	Erosion strain in transverse direction (see Figure 2-109): $\epsilon_{b,\text{fail}}$

Remarks:

1. Strain rate effects are accounted for using a Cowper-Symonds model which scales the stress according to the strain rate:

$$\sigma^{\text{adj}} = \sigma \left(1 + \frac{\dot{\epsilon}}{C} \right)^{\frac{1}{P}}$$

In the above equation σ is the quasi-static stress, σ^{adj} is the adjusted stress accounting for strain rate $\dot{\epsilon}$, C (CCE) and P (PCE) are the Cowper-Symonds factors and have to be determined experimentally for each material.

The model captures the non-linear strain rate effects in many materials. With its less than unity exponent, $1/p$, this model captures the rapid increase in material properties at low strain rate, while increasing less rapidly at very high strain rates. Because stress is a function of strain rate the elastic stiffness also is:

$$\mathbf{E}^{\text{adj}} = \mathbf{E} \left(1 + \frac{\dot{\epsilon}}{C} \right)^{\frac{1}{P}}$$

where \mathbf{E}^{adj} is the adjusted elastic stiffness. Additionally, the strains to peak and strains to failure are assumed to follow a Cowper-Symonds model with, *possibly different*, constants

$$\epsilon^{\text{adj}} = \epsilon \left(1 + \frac{\dot{\epsilon}}{C_s} \right)^{\frac{1}{P_s}}$$

where, ϵ^{adj} is the adjusted effective strain to peak stress or strain to failure, and C_s and P_s are CSE and PSE respectively.

2. When strained beyond the peak stress, the stress decreases linearly until it attains a value equal to SIGPOST, at which point the stress-strain relation becomes nonlinear. In the non-linear region the stress is given by

$$\sigma = \sigma_{\text{post}} \left[1 - \left(\frac{\varepsilon - \varepsilon_{[a/b],\text{post}}}{\varepsilon_{[a/b],\text{fail}} - \varepsilon_{[a/b],\text{post}}} \right)^{d_{\text{fac}}} \right]$$

where σ_{post} and $\varepsilon_{\text{post}}$ are, respectively, the stress and strain demarcating the onset of nonlinear behavior. The value of SIGPOST is the same in both the transverse and longitudinal directions, whereas $\varepsilon_{a,\text{post}}$ and $\varepsilon_{b,\text{post}}$ depend on direction and are derived internally from EASF, EBSF, and SIGPOST. The failure strain, $\varepsilon_{[a/b],\text{fail}}$, specifies the onset of failure and differs in the longitudinal and transverse directions. Lastly the exponent, d_{fac} , determines the shape of nonlinear stress-strain curve between $\varepsilon_{\text{post}}$ and $\varepsilon_{[a/b],\text{fail}}$.

3. The element is eroded if either (a) or (b) is satisfied:

- a) $\varepsilon_a > \varepsilon_{a,\text{fail}}$ and $\varepsilon_b > \varepsilon_{b,\text{fail}}$
- b) $\varepsilon_a > \varepsilon_{\text{max}}$ and $\varepsilon_b > \varepsilon_{\text{max}}$.

***MAT_RIGID_DISCRETE**

This is Material Type 220, a rigid material for shells or solids. Unlike *MAT_020, a *MAT_220 part can be discretized into multiple disjoint pieces and have each piece behave as an independent rigid body. The inertia properties for the disjoint pieces are determined directly from the finite element discretization.

Nodes of a *MAT_220 part cannot be shared by any other rigid part. A *MAT_220 part may share nodes with deformable solids but it should not share nodes with deformable structural elements (shells, beams) as only the translational forces are transmitted through the shared nodes.

This material option can be used to model granular material where the grains interact through an automatic single surface contact definition. Another possible use includes modeling bolts as rigid bodies where the bolts belong to the same part ID. This model eliminates the need to represent each rigid piece with a unique part ID.

Card	1	2	3	4	5	6	7	8
Variable	MID	RO	E	PR				
Type	A8	F	F	F				
Default	none	none	none	none				

VARIABLE**DESCRIPTION**

MID	Material identification. A unique number or label not exceeding 8 characters must be specified.
RO	Mass density.
E	Young's modulus.
PR	Poisson's ratio.

***MAT_ORTHOTROPIC_SIMPLIFIED_DAMAGE**

This is Material Type 221. An orthotropic material with optional simplified damage and optional failure for composites can be defined. This model is valid only for 3D solid elements, with reduced or full integration. The elastic behavior is the same as MAT_022. Nine damage variables are defined, applicable to E_a , E_b , E_c , (damage is different in tension and compression), and G_{ab} , G_{bc} and G_{ca} . In addition, nine failure criteria on strains are available. When failure occurs, elements are deleted (erosion). Failure depends on the number of integration points failed through the element. See the material description below.

Card 1	1	2	3	4	5	6	7	8
Variable	MID	RO	EA	EB	EC	PRBA	PRCA	PRCB
Type	A8	F	F	F	F	F	F	F
Default	none	none	none	none	none	none	none	none

Card 2	1	2	3	4	5	6	7	8
Variable	GAB	GBC	GCA		AOPT	MACF		
Type	F	F	F		F	I		
Default	none	none	none		0.0	0		

Card 3	1	2	3	4	5	6	7	8
Variable	XP	YP	ZP	A1	A2	A3		
Type	F	F	F	F	F	F		
Default	0.0	0.0	0.0	0.0	0.0	0.0		

Card 4	1	2	3	4	5	6	7	8
Variable	V1	V2	V3	D1	D2	D3	BETA	
Type	F	F	F	F	F	F	F	
Default	0.0	0.0	0.0	0.0	0.0	0.0	0.0	

Card 5	1	2	3	4	5	6	7	8
Variable	NERODE	NDAM	EPS1TF	EPS2TF	EPS3TF	EPS1CF	EPS2CF	EPS3CF
Type	I	I	F	F	F	F	F	F
Default	0	0	1.E20	1.E20	1.E20	-1.E20	-1.E20	-1.E20

Card 6	1	2	3	4	5	6	7	8
Variable	EPS12F	EPS23F	EPS13F	EPSD1T	DPSC1T	CDAM1T	EPSD2T	EPSC2T
Type	F	F	F	F	F	F	F	F
Default	1.E20	1.E20	1.E20	0.	0.	0.	0.	0.

Card 7	1	2	3	4	5	6	7	8
Variable	CDAM2T	EPSD3T	EPSC3T	CDAM3T	EPSD1C	EPSC1C	CDAM1C	EPSD2C
Type	I	I	F	F	F	F	F	F
Default	0.	0.	0.	0.	0.	0.	0.	0.

Card 8	1	2	3	4	5	6	7	8
Variable	EPSC2C	CDAM2C	EPSD3C	EPSC3C	CDAM3C	EPSD12	EPSC12	CDAM12
Type	F	F	F	F	F	F	F	F
Default	0.	0.	0.	0.	0.	0.	0.	0.

Card 9	1	2	3	4	5	6	7	8
Variable	EPSD23	EPSC23	CDAM23	EPSD31	EPSC31	CDAM31		
Type	F	F	F	F	F	F		
Default	0.	0.	0.	0.	0.	0.		

VARIABLE**DESCRIPTION**

MID	Material identification. A unique number or label not exceeding 8 characters must be specified.
RO	Mass density
EA	E_a , Young's modulus in a-direction.
EB	E_b , Young's modulus in b-direction.
EC	E_c , Young's modulus in c-direction.
PRBA	ν_{ba} , Poisson ratio, ba.
PRCA	ν_{ca} , Poisson ratio, ca.
PRCB	ν_{cb} , Poisson ratio, cb.
GAB	G_{ab} , Shear modulus, ab.
GBC	G_{bc} , Shear modulus, bc.
GCA	G_{ca} , Shear modulus, ca.
AOPT	Material axes option (see MAT_OPTIONTROPIC_ELASTIC for a

VARIABLE	DESCRIPTION
	more complete description):
	EQ.0.0: locally orthotropic with material axes determined by element nodes 1, 2, and 4, as with *DEFINE_COORDINATE_NODES.
	EQ.1.0: locally orthotropic with material axes determined by a point in space and the global location of the element center; this is the a-direction. This option is for solid elements only.
	EQ.2.0: globally orthotropic with material axes determined by vectors defined below, as with *DEFINE_COORDINATE_VECTOR.
	EQ.3.0: locally orthotropic material axes determined by rotating the material axes about the element normal by an angle, BETA, from a line in the plane of the element defined by the cross product of the vector v with the element normal.
	EQ.4.0: locally orthotropic in cylindrical coordinate system with the material axes determined by a vector v, and an originating point, p, which define the centerline axis. This option is for solid elements only.
	LT.0.0: the absolute value of AOPT is a coordinate system ID number (CID on *DEFINE_COORDINATE_NODES, *DEFINE_COORDINATE_SYSTEM or *DEFINE_COORDINATE_VECTOR).
MACF	Material axes change flag for brick elements:
	EQ.1: No change, default,
	EQ.2: switch material axes a and b,
	EQ.3: switch material axes a and c,
	EQ.4: switch material axes b and c.
XP, YP, ZP	Coordinates of point p for AOPT = 1 and 4.
A1, A2, A3	Components of vector a for AOPT = 2.
V1, V2, V3	Components of vector v for AOPT = 3 and 4.
D1, D2, D3	Components of vector d for AOPT = 2.

VARIABLE	DESCRIPTION
BETA	Material angle in degrees for AOPT = 3, may be overridden on the element card, see *ELEMENT_SOLID_ORTHO.
NERODE	Failure and erosion flag: EQ.0: No failure (default) EQ.1: Failure as soon as one failure criterion is reached in all integration points EQ.2: Failure as soon as one failure criterion is reached in at least one integration point EQ.3: Failure as soon as a tension or compression failure criterion in the a-direction is reached for one integration point EQ.4: Failure as soon as a tension or compression failure criterion in the b-direction is reached for one integration point EQ.5: Failure as soon as a tension or compression failure criterion in the c-direction is reached for one integration point EQ.6: Failure as soon as tension or compression failure criteria in both the a- and b-directions are reached at a single integration point or at 2 different integration points EQ.7: Failure as soon as tension or compression failure criteria in both the b- and c-directions are reached at a single integration point or at 2 different integration points EQ.8: Failure as soon as tension or compression failure criteria in both the a- and c-directions are reached at a single integration point or at 2 different integration points EQ.9: Failure as soon as tension or compression failure criteria in the 3 directions are reached at a single integration point or at different integration points
NDAM	Damage flag: EQ.0: No damage (default) EQ.1: Damage in tension only (null for compression) EQ.2: Damage in tension and compression
EPS1TF	Failure strain in tension along the a-direction
EPS2TF	Failure strain in tension along the b-direction
EPS3TF	Failure strain in tension along the c-direction

VARIABLE	DESCRIPTION
EPS1CF	Failure strain in compression along the a-direction
EPS2CF	Failure strain in compression along the b-direction
EPS3CF	Failure strain in compression along the c-direction
EPS12F	Failure shear strain in the ab-plane
EPS23F	Failure shear strain in the bc-plane
EPS13F	Failure shear strain in the ac-plane
EPD1T	Damage threshold in tension along the a-direction, ϵ_{1t}^s
EPD2T	Damage threshold in tension along the b-direction, ϵ_{2t}^s
EPD3T	Damage threshold in tension along the c-direction, ϵ_{3t}^s
EPD1C	Damage threshold in compression along the a-direction, ϵ_{1c}^s
EPD2C	Damage threshold in compression along the b-direction, ϵ_{2c}^s
EPD3C	Damage threshold in compression along the c-direction, ϵ_{3c}^s
EPSC1T	Critical damage threshold in tension along the a-direction, ϵ_{1t}^c
EPSC2T	Critical damage threshold in tension along the b-direction, ϵ_{2t}^c
EPSC3T	Critical damage threshold in tension along the c-direction, ϵ_{3t}^c
EPSC1C	Critical damage threshold in compression along the a-direction, ϵ_{1c}^c
EPSC2C	Critical damage threshold in compression along the b-direction, ϵ_{2c}^c
EPSC3C	Critical damage threshold in compression along the c-direction, ϵ_{3c}^c
CDAM1T	Critical damage in tension along the a-direction, D_{1t}^c
CDAM2T	Critical damage in tension along the b-direction, D_{2t}^c
CDAM3T	Critical damage in tension along the c-direction, D_{3t}^c
CDAM1C	Critical damage in compression along the a-direction, D_{1c}^c
CDAM2C	Critical damage in compression along the b-direction, D_{2c}^c
CDAM3C	Critical damage in compression along the c-direction, D_{3c}^c

VARIABLE	DESCRIPTION
CDAM3C	Critical damage in compression along the c-direction, D_{3c}^c
EPSD12	Damage threshold for shear in the ab-plane, ε_{12}^s
EPSC12	Critical damage threshold for shear in the ab-plane, ε_{12}^c
CDAM12	Critical damage for shear in the ab-plane, D_{12}^c
EPSD23	Damage threshold for shear in the bc-plane, ε_{23}^s
EPSC23	Critical damage threshold for shear in the bc-plane, ε_{23}^c
CDAM23	Critical damage for shear in the bc-plane, D_{23}^c
EPSD31	Damage threshold for shear in the ac-plane, ε_{31}^s
EPSC31	Critical damage threshold for shear in the ac-plane, ε_{31}^c
CDAM31	Critical damage for shear in the ac-plane, D_{31}^c

Remarks:

If $\varepsilon_k^c < \varepsilon_k^s$, no damage is considered. Failure occurs only when failure strain is reached.

Failure can occur along the 3 orthotropic directions, in tension, in compression and for shear behavior. Nine failure strains drive the failure. When failure occurs, elements are deleted (erosion). Under the control of the NERODE flag, failure may occur either when only one integration point has failed, when several integration points have failed or when all integrations points have failed.

Damage applies to the 3 Young's moduli and the 3 shear moduli. Damage is different for tension and compression. Nine damage variables are used: d_{1t} , d_{2t} , d_{3t} , d_{1c} , d_{2c} , d_{3c} , d_{12} , d_{23} , d_{13} . The damaged flexibility matrix is:

$$-S^{\text{dam}} = \begin{pmatrix} \frac{1}{E_a(1-d_{1t/c})} & \frac{-v_{ba}}{E_b} & \frac{-v_{ca}}{E_c} & 0 & 0 & 0 \\ \frac{-v_{ba}}{E_b} & \frac{1}{E_b(1-d_{2t/c})} & \frac{-v_{cb}}{E_c} & 0 & 0 & 0 \\ \frac{-v_{ca}}{E_c} & \frac{-v_{cb}}{E_c} & \frac{1}{E_c(1-d_{3t/c})} & 0 & 0 & 0 \\ 0 & 0 & 0 & \frac{1}{G_{ab}(1-d_{12})} & 0 & 0 \\ 0 & 0 & 0 & 0 & \frac{1}{G_{bc}(1-d_{23})} & 0 \\ 0 & 0 & 0 & 0 & 0 & \frac{1}{G_{ca}(1-d_{31})} \end{pmatrix}$$

The nine damage variables are calculated as follows:

$$d_k = \max \left(d_k; D_k^c \left\langle \frac{\varepsilon_k - \varepsilon_k^s}{\varepsilon_k^c - \varepsilon_k^s} \right\rangle_+ \right)$$

with $k = 1t, 2t, 3t, 1c, 2c, 3c, 12, 23, 31$.

$$\langle \ \rangle_+ \text{ is the positive part: } \langle x \rangle_+ = \begin{cases} x & \text{if } x > 0 \\ 0 & \text{if } x < 0 \end{cases}$$

Damage in compression may be deactivated with the NDAM flag. In this case, damage in compression is null, and only damage in tension and for shear behavior are taken into account.

The nine damage variables may be post-processed through additional variables. The number of additional variables for solids written to the d3plot and d3thdt databases is input by the optional *DATABASE_EXTENT_BINARY card as variable NEIPH. These additional variables are tabulated below:

History Variable	Description	Value	LS-PrePost history variable
d _{1t}	damage in traction along a	0 - no damage 0 < d _k ≤ D _k ^c - damage	plastic strain
d _{2t}	damage in traction along b		1
d _{3t}	damage in traction along c		2
d _{1c}	damage in compression along a		3
d _{2c}	damage in compression along b		4
d _{3c}	damage in compression along c		5
d ₁₂	shear damage in ab-plane		6
d ₂₃	shear damage in bc-plane		7
d ₁₃	shear damage in ac-plane		8

The first damage variable is stored as in the place of effective plastic strain. The eight other damage variables may be plotted in LS-PrePost as element history variables.

***MAT_TABULATED_JOHNSON_COOK**

This is Material Type 224. An elasto-viscoplastic material with arbitrary stress versus strain curve(s) and arbitrary strain rate dependency can be defined. Plastic heating causes adiabatic temperature increase and material softening. Optional plastic failure strain can be defined as a function of triaxiality, strain rate, temperature and/or element size. This material model resembles the original Johnson-Cook material (see *MAT_015) but with the possibility of general tabulated input parameters.

An equation of state (*EOS) is optional for solid elements, tshell formulations 3 and 5, and 2D continuum elements, and is invoked by setting EOSID to a nonzero value in *PART. If an equation of state is used, only the deviatoric stresses are calculated by the material model and the pressure is calculated by the equation of state.

Card 1	1	2	3	4	5	6	7	8
Variable	MID	RO	E	PR	CP	TR	BETA	NUMINT
Type	A8	F	F	F	F	F	F	F
Default	none	none	none	none	none	0.0	1.0	1.0

Card 2	1	2	3	4	5	6	7	8
Variable	LCK1	LCKT	LCF	LCG	LCH	LCI		
Type	F	F	F	F	F	F		
Default	0	0	0	0	0	0		

Optional card 3

Card 3	1	2	3	4	5	6	7	8
Variable	FAILOPT	NUMAVG	NCYFAIL					
Type	F	F	F					

VARIABLE	DESCRIPTION
MID	Material identification. A unique number or label not exceeding 8 characters must be specified.
RO	Mass density.
E	Young's modulus: GT.0.0: constant value is used LT.0.0: temperature dependent Young's modulus given by load curve ID = -E (starting with release 971 R6)
PR	Poisson's ratio.
CP	Specific heat (superseded by heat capacity in *MAT_THERMAL_OPTION if a coupled thermal/structural analysis).
TR	Room temperature.
BETA	Amount of plastic work converted into heat.
NUMINT	GT.0.0: Number of integration points which must fail before the element is deleted. Available for shells and solids. LT.0.0: NUMINT is percentage of integration points/layers which must fail before shell element fails. For fully integrated shells, a methodology is used where a layer fails if one integration point fails and then the given percentage of layers must fail before the element fails. Only available for shells except as noted below EQ.-200: Turns off erosion for shells and solids. Not recommended unless used in conjunction with *CONSTRAINED_TIED_NODES_FAILURE.
LCK1	Load curve ID or Table ID. The load curve ID defines effective stress as a function of effective plastic strain. The table ID defines for each plastic strain rate value a load curve ID giving the (isothermal) effective stress versus effective plastic strain for that rate.
LCKT	Table ID defining for each temperature value a load curve ID giving the (quasi-static) effective stress versus effective plastic strain for that temperature.

VARIABLE	DESCRIPTION
LCF	Load curve ID or Table ID. The load curve ID defines plastic failure strain (or scale factor – see Remarks) as a function of triaxiality. The table ID defines for each Lode parameter a load curve ID giving the plastic failure strain versus triaxiality for that Lode parameter. (Table option only for solids and not yet generally supported). See Remarks for a description of the combination of LCF, LCG, LCH, and LCI.
LCG	Load curve ID defining plastic failure strain (or scale factor – see Remarks) as a function of plastic strain rate. See Remarks for a description of the combination of LCF, LCG, LCH, and LCI.
LCH	Load curve ID defining plastic failure strain (or scale factor – see Remarks) as a function of temperature. See Remarks for a description of the combination of LCF, LCG, LCH, and LCI.
LCI	Load curve ID or Table ID. The load curve ID defines plastic failure strain (or scale factor – see Remarks) as a function of element size. The table ID defines for each triaxiality a load curve ID giving the plastic failure strain versus element size for that triaxiality. See Remarks for a description of the combination of LCF, LCG, LCH, and LCI.
FAILOPT	Flag for additional failure criterion F_2 , see Remarks. EQ.0.0: off (default) EQ.1.0: on
NUMAVG	Number of time steps for running average for plastic failure strain in the additional failure criterion.
NCYFAIL	Number of time steps that the additional failure criterion must be met before element deletion.

Remarks:

The flow stress σ_y is expressed as a function of plastic strain ϵ_p , plastic strain rate $\dot{\epsilon}_p$ and temperature T via the following formula (using load curves/tables LCK1 and LCKT):

$$s_y = k_1(\epsilon_p, \dot{\epsilon}_p) \frac{k_t(\epsilon_p, T)}{k_t(\epsilon_p, T_R)}$$

Note that T_R is a material parameter and should correspond to the temperature used when performing the room temperature tensile tests. If simulations are to be performed with an

initial temperature T_I deviating from T_R then this temperature should be set using *INITIAL_STRESS_SOLID/SHELL by setting the following history variables:

History variable #11 (solids) or #7 (shells)

$$\frac{(T_I - T_R)C_p\rho}{\beta}$$

History variable #14 (solids) or #10 (shells)

$$T_I$$

Optional plastic failure strain is defined as a function of triaxiality p/σ_{vm} , Lode parameter, plastic strain rate $\dot{\epsilon}_p$, temperature T and element size l_0 (square root of element area for shells and volume over maximum area for solids) by

$$\epsilon_{pf} = f\left(\frac{p}{\sigma_{vm}}, \frac{27J_3}{2\sigma_{vm}^3}\right)g(\dot{\epsilon}_p)h(T)i(l_c)$$

using load curves/tables LCF, LCG, LCH and LCI. If more than one of these four variables LCF, LCG, LCH and LCI are defined, be aware that the net plastic failure strain is essentially the product of multiple functions as shown in the above equation. This means that one and only one of the variables LCF, LCG, LCH, and LCI can point to curve(s) that have plastic strain along the curve ordinate. The remaining nonzero variable(s) LCF, LCG, LCH, and LCI should point to curve(s) that have a unitless scaling factor along the curve ordinate.

A typical failure curve LCF for metal sheet, modeled with shell elements is shown in [Figure 2-110](#). Triaxiality should be monotonically increasing in this curve. A reasonable range for triaxiality is -2/3 to 2/3 if shell elements are used (plane stress). For 3-dimensional stress states (solid elements), the possible range of triaxiality goes from $-\infty$ to $+\infty$, but to get a good resolution in the internal load curve discretization (depending on parameter LCINT of *CONTROL_SOLUTION) one should define lower limits, e.g. -1 to 1 if LCINT = 100 (default).

The default failure criterion of this material model depends on plastic strain evolution $\dot{\epsilon}_p$ and on plastic failure strain ϵ_{pf} and is obtained by accumulation over time:

$$F = \int \frac{\dot{\epsilon}_p}{\epsilon_{pf}} dt$$

where element erosion takes place when $F \geq 1$. This accumulation provides load-path dependent treatment of failure.

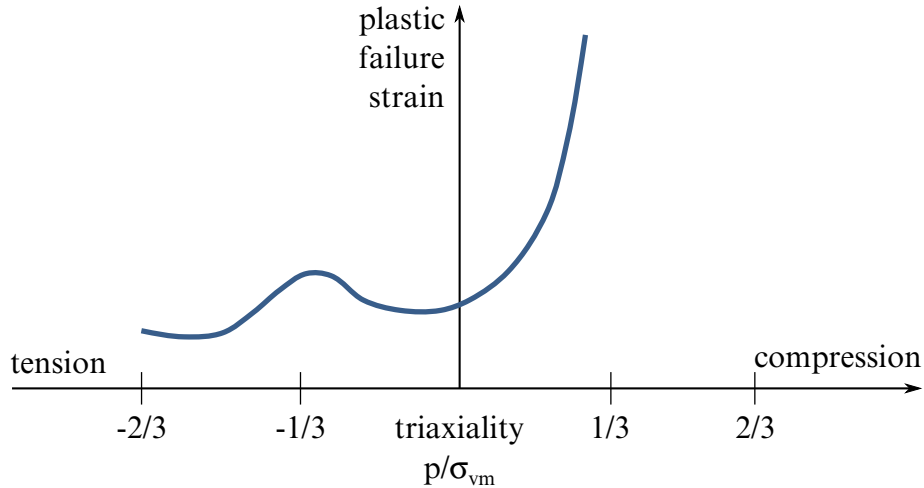

Figure 2-110. Typical failure curve for metal sheet, modeled with shell elements

An additional, load-path independent, failure criterion can be invoked by setting FAILOPT = 1, where the current state of plastic strain is used:

$$F_2 = \frac{\epsilon_p}{\epsilon_{pf}}$$

Two additional parameters can be used as countermeasures against stress oscillations for this failure criterion. When NUMAVG is invoked, plastic failure strain is averaged over NUMAVG time steps for the F_2 criterion. NUMAVG cannot exceed 30. NCYFAIL defines the number of cycles that $F_2 \geq 1$ must be met before element deletion takes place.

Temperature increase is caused by plastic work

$$T = T_R + \frac{\beta}{C_p \rho} \int \sigma_y \dot{\epsilon}_p$$

with room temperature T_R , dissipation factor β , specific heat C_p , and density ρ .

For *CONSTRAINED_TIED_NODES_WITH_FAILURE, the failure is based on the damage instead to the plastic strain.

History variables may be post-processed through additional variables. The number of additional variables for shells/solids written to the d3plot and d3thdt databases is input by the optional *DATABASE_EXTENT_BINARY card as variable NEIPS/NEIPH. The relevant additional variables of this material model are tabulated below:

LS-PrePost history variable #	Shell elements	LS-PrePost history variable #	Solid elements
1	<i>plastic strain rate</i>	5	<i>plastic strain rate</i>
7	<i>plastic work</i>	8	<i>plastic failure strain</i>
8	<i>ratio of plastic strain to plastic failure strain</i>	9	<i>triaxiality</i>
9	<i>element size</i>	10	<i>Lode parameter</i>
10	<i>temperature</i>	11	<i>plastic work</i>
11	<i>plastic failure strain</i>	12	<i>ratio of plastic strain to plastic failure strain</i>
12	<i>triaxiality</i>	13	<i>element size</i>
		14	<i>temperature</i>

***MAT_VISCOPLASTIC_MIXED_HARDENING**

This is Material Type 225. An elasto-viscoplastic material with an arbitrary stress versus strain curve and arbitrary strain rate dependency can be defined. Kinematic, isotropic, or a combination of kinematic and isotropic hardening can be specified. Also, failure based on plastic strain can be defined.

Card 1	1	2	3	4	5	6	7	8
Variable	MID	RO	E	PR	LCSS	BETA		
Type	A8	F	F	F	I	F		
Default	none	none	none	none	none	0.0		

Card 2	1	2	3	4	5	6	7	8
Variable	FAIL							
Type	F							
Default	1.0E+20							

VARIABLE**DESCRIPTION**

MID	Material identification. A unique number or label not exceeding 8 characters must be specified.
RO	Mass density.
E	Young's modulus.
PR	Poisson's ratio.

VARIABLE	DESCRIPTION
LCSS	<p>Load curve ID or Table ID. Load curve ID defining effective stress versus effective plastic strain The table ID defines for each strain rate value a load curve ID giving the stress versus effective plastic strain for that rate, See Figure 2-12. The stress versus effective plastic strain curve for the lowest value of strain rate is used if the strain rate falls below the minimum value. Likewise, the stress versus effective plastic strain curve for the highest value of strain rate is used if the strain rate exceeds the maximum value. NOTE: The strain rate values defined in the table may be given as the natural logarithm of the strain rate. If the <i>first</i> stress-strain curve in the table corresponds to a negative strain rate, LS-DYNA assumes that the natural logarithm of the strain rate value is used. Since the tables are internally discretized to equally space the points, natural logarithms are necessary, for example, if the curves correspond to rates from 10.e-04 to 10.e+04.</p>
BETA	<p>Hardening parameter, $0 < \text{BETA} < 1$.</p> <p>EQ.0.0: Pure kinematic hardening</p> <p>EQ.1.0: Pure isotropic hardening</p> <p>0.0 < BETA < 1.0: Mixed hardening</p>
FAIL	<p>Failure flag.</p> <p>LT.0.0: User defined failure subroutine is called to determine failure</p> <p>EQ.0.0: Failure is not considered. This option is recommended if failure is not of interest since many calculations will be saved.</p> <p>GT.0.0: Plastic strain to failure. When the plastic strain reaches this value, the element is deleted from the calculation..</p>

***MAT_KINEMATIC_HARDENING_BARLAT89**

This is Material Type 226. This model combines Yoshida non-linear kinematic hardening rule (*MAT_125) with the 3-parameter material model of Barlat and Lian [1989] (*MAT_36) to model metal sheets under cyclic plasticity loading and with anisotropy in plane stress condition. Lankford parameters are used for the definition of the anisotropy. Yoshida's theory describes the hardening rule with 'two surfaces' method: the yield surface and the bounding surface. In the forming process, the yield surface does not change in size, but its center moves with deformation; the bounding surface changes both in size and location.

Card 1	1	2	3	4	5	6	7	8
Variable	MID	R0	E	PR	M	R00	R45	R90
Type	I	F	F	F	F	F	F	F
Default	none	0.0	0.0	0.0	0.0	0.0	0.0	none

Card 2	1	2	3	4	5	6	7	8
Variable	CB	Y	SC	K	RSAT	SB	H	HLCID
Type	F	F	F	F	F	F	F	I
Default	0.0	0.0	0.0	0.0	0.0	0.0	0.0	none

Card 3	1	2	3	4	5	6	7	8
Variable	AOPT	IOPT	C1	C2				
Type	F	I	F	F				
Default	none	none	0.0	0.0				

Card 4	1	2	3	4	5	6	7	8
Variable	XP	YP	ZP	A1	A2	A3		
Type	F	F	F	F	F	F		
Default	none	none	none	none	none	none		

Card 5	1	2	3	4	5	6	7	8
Variable	V1	V2	V3	D1	D2	D3	BETA	
Type	F	F	F	F	F	F	F	
Default	none	none	none	none	none	none	none	

VARIABLE**DESCRIPTION**

MID	Material identification. A unique number must be specified.
RO	Mass density.
E	Young's modulus, E.
PR	Poisson's ratio, ν .
M	m , exponent in Barlat's yield criterion.
R ₀₀	R ₀₀ , Lankford parameter in 0 degree direction.
R ₄₅	R ₄₅ , Lankford parameter in 45 degree direction.
R ₉₀	R ₉₀ , Lankford parameter in 90 degree direction.
CB	The uppercase B defined in the Yoshida's equations.
Y	Hardening parameter as defined in the Yoshida's equations.
SC	The lowercase c defined in the Yoshida's equations.
K	Hardening parameter as defined in the Yoshida's equations.

VARIABLE	DESCRIPTION
RSAT	Hardening parameter as defined in the Yoshida's equations.
SB	The lowercase b as defined in the Yoshida's equations.
H	Anisotropic parameter associated with work-hardening stagnation, defined in the Yoshida's equations.
HLCID	Load curve ID in keyword *DEFINE_CURVE, where true strain and true stress relationship is characterized. The load curve is optional, and is used for error calculation only.
IOPT	Kinematic hardening rule flag: EQ.0: Original Yoshida formulation, EQ.1: Modified formulation: Define C1, C2 as below.
C1, C2	Constants used to modify R: $R = RSAT \times [(C_1 + \bar{\epsilon}^p)^{c_2} - C_1^{c_2}]$
AOPT	Material axes option (see MAT_OPTION TROPIC_ELASTIC for a more complete description): EQ.0.0: locally orthotropic with material axes determined by element nodes 1, 2, and 4, as with *DEFINE_COORDINATE_NODES, and then rotated about the shell element normal by the angle BETA. EQ.2.0: globally orthotropic with material axes determined by vectors defined below, as with *DEFINE_COORDINATE_VECTOR: EQ.3.0: locally orthotropic material axes determined by rotating the material axes about the element normal by an angle, BETA, from a line in the plane of the element defined by the cross product of the vector v with the element normal: LT.0.0: the absolute value of AOPT is a coordinate system ID number (CID on *DEFINE_COORDINATE_NODES, *DEFINE_COORDINATE_SYSTEM or *DEFINE_COORDINATE_VECTOR): Available with the R3 release of Version 971 and later.
XP, YP, ZP	Coordinates of point p for AOPT = 1.
A1, A2, A3	Components of vector a for AOPT = 2.

VARIABLE	DESCRIPTION
V1, V2, V3	Components of vector v for AOPT = 3.
D1, D2, D3	Components of vector d for AOPT = 2.
BETA	Material angle in degrees for AOPT = 0 and 3, may be overridden on the element card, see *ELEMENT_SHELL_BETA.

On Barlat and Lian's yield criterion:

The R-values are defined as the ratio of instantaneous width change to instantaneous thickness change. That is, assume that the width *W* and thickness *T* are measured as function of strain. Then the corresponding R-value is given by:

$$R = \frac{\frac{dW}{d\varepsilon} / W}{\frac{dT}{d\varepsilon} / T}$$

Input R00, R45 and R90 to define sheet anisotropy in the rolling, 45 degree and 90 degree direction.

Barlat and Lian's [1989] anisotropic yield criterion Φ for plane stress is defined as:

$$\Phi = a|K_1 + K_2|^m + a|K_1 - K_2|^m + c|2K_2|^m = 2\sigma_Y^m$$

for face centered cubic (FCC) materials exponent $m = 8$ is recommended and for body centered cubic (BCC) materials $m = 6$ may be used. Detailed description on the criterion can be found in *MAT_036 manual pages.

On Yoshida nonlinear kinematic hardening model:

The Yoshida's model accounts for cyclic plasticity including Bauschinger effect and cyclic hardening behavior. For detailed Yoshida's theory of nonlinear kinematic hardening rule and definitions of material constants *CB*, *Y*, *SC*, *K*, *RSAT*, *SB*, and *H*, refer to **Remarks** in *MAT_125 manual pages and in the original paper, "A model of large-strain cyclic plasticity describing the Bauschinger effect and workhardening stagnation", by Yoshida, F. and Uemori, T., *Int. J. Plasticity*, vol. 18, 661-689, 2002.

Further improvements in the original Yoshida's model, as described in a paper "Determination of Nonlinear Isotropic/Kinematic Hardening Constitutive Parameter for AHSS using Tension and Compression Tests", by Shi, M.F., Zhu, X.H., Xia, C., and Stoughton, T., in *NUMISHEET 2008 proceedings*, 137-142, 2008, included modifications to allow work hardening in large strain deformation region, avoiding the problem of earlier saturation, especially for Advanced High Strength Steel (AHSS). These types of steels exhibit continuous strain hardening behavior and a non-saturated isotropic hardening function. As described in the paper,

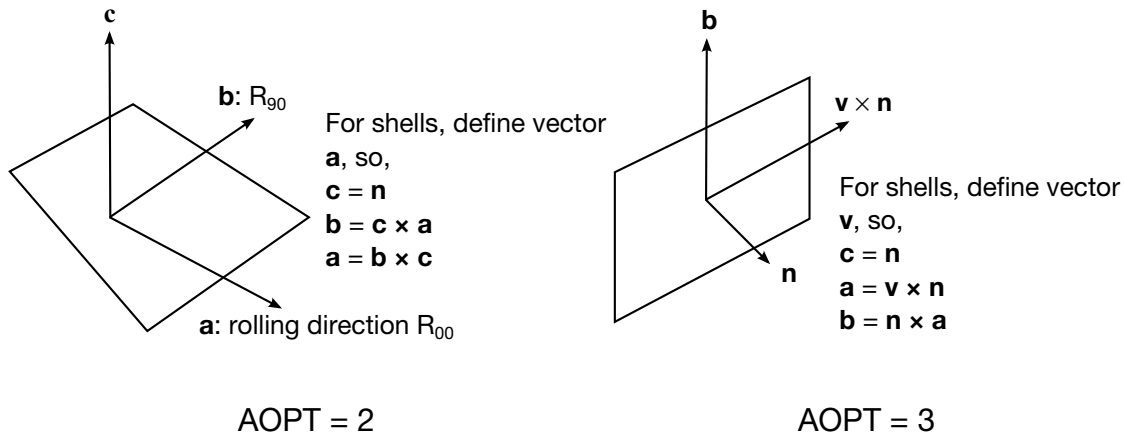

Figure 2-111. Defining sheet metal rolling direction.

the evolution equation for R (a part of the current radius of the bounding surface in deviatoric stress space), as is with the saturation type of isotropic hardening rule proposed in the original Yoshida model,

$$\dot{R} = m(R_{sat} - R)\dot{p}$$

is modified as,

$$R = RSAT \times [(C_1 + \bar{\epsilon}^p)^{c_2} - C_1^{c_2}]$$

For saturation type of isotropic hardening rule, set IOPT = 0, applicable to most of Aluminum sheet materials. In addition, the paper provides detailed variables used for this material model for DDQ, HSLA, DP600, DP780 and DP980 materials. Since the symbols used in the paper are different from what are used here, the following table provides a reference between symbols used in the paper and variables here in this keyword:

B	Y	C	m	K	b	h	e^0	N
CB	Y	SC	K	Rsat	SB	H	C1	C2

Using the modified formulation and the material properties provided by the paper, the predicted and tested results compare very well both in a full cycle tension and compression test and in a pre-strained tension and compression test, according to the paper. A set of experiments are required to fit (optimize) the Yoshida material constants, and these experiments include a uniaxial tension test (used for HLCID), a full cycle tension and compression test and a multiple cycle tension and compression test.

Defining the rolling direction of a sheet metal:

The variable AOPT is used to define the rolling direction of the sheet metals. For shells, AOPT of 2 or 3 are relevant. When AOPT = 2, define vector components of **a** in the direction of the rolling (R_{00}); when AOPT = 3, define vector components of **v** perpendicular to the rolling direction, as shown in [Figure 2-111](#).

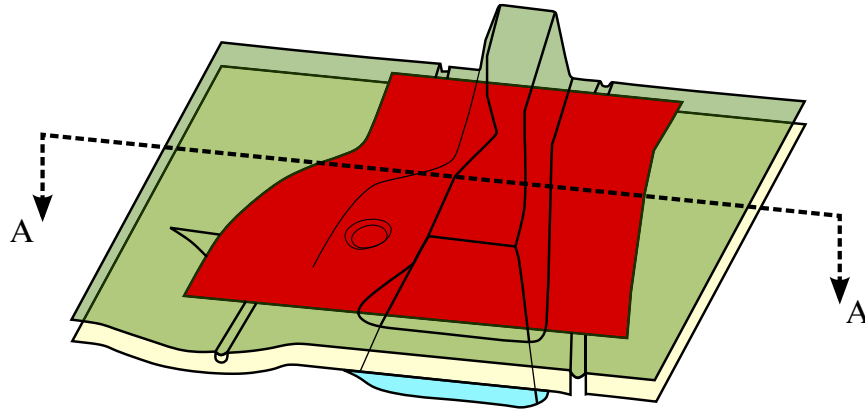

Figure 2-112. The NUMISHEET 2005 cross member and section definition.

Application:

Application of the modified Yoshida’s hardening rule in the metal forming industry has shown significant improvement in springback prediction accuracy, which is a pre-requisite for a successful stamping tool compensation, especially for AHSS type of sheet materials.

In an example shown in [Figure 2-112](#), springback simulation was performed following drawing and trimming on the NUMISHEET 2005 cross member for aluminum alloy AL5182-O, using *MAT_226. In [Figure 2-113](#), springback shape was recovered from section A-A ([Figure 2-112](#)), and compared with those results from simulation using *MAT_037 and *MAT_125. Though all are remarkably close, results with *MAT_226 on the cross section (Y = -370 mm) show better springback correlation to the measured test data than those with *MAT_125 and *MAT_37.

To improve convergence, it is recommended that *CONTROL_IMPLICIT_FORMING type ‘1’ be used when conducting springback simulation.

Revision information:

This material model is available in LS-DYNA R5 Revision 57717 or later releases.

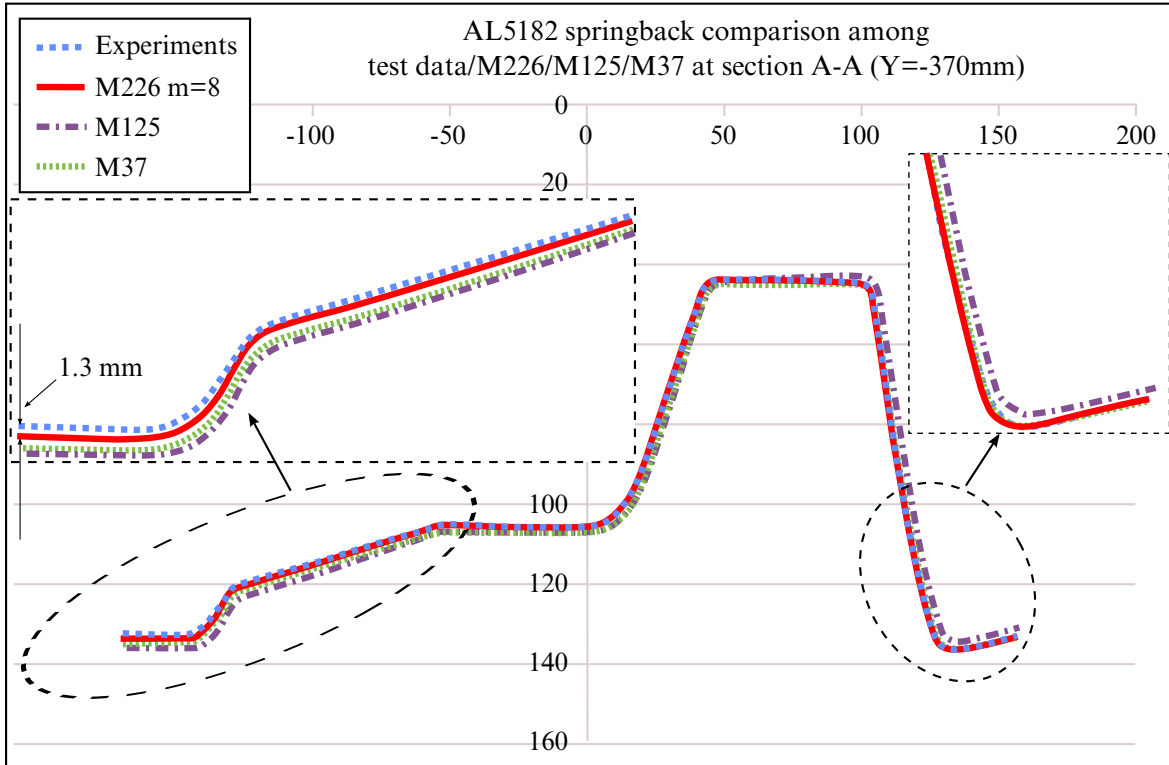

Figure 2-113. Springback prediction with *MAT_226 (Material properties courtesy of Ford Motor Company Research and Innovation Laboratory).

***MAT_PML_ELASTIC**

This is Material Type 230. This is a perfectly-matched layer (PML) material — an absorbing layer material used to simulate wave propagation in an unbounded isotropic elastic medium — and is available only for solid 8-node bricks (element type 2). This material implements the 3D version of the Basu-Chopra PML [Basu and Chopra (2003,2004), Basu (2009)].

Card	1	2	3	4	5	6	7	8
Variable	MID	RO	E	PR				
Type	A8	F	F	F				
Default	none	none	none	none				

VARIABLE**DESCRIPTION**

MID	Material identification. A unique number or label not exceeding 8 characters must be specified.
RO	Mass density.
E	Young's modulus.
PR	Poisson's ratio.

Remarks:

1. A layer of this material may be placed at a boundary of a bounded domain to simulate unboundedness of the domain at that boundary: the layer absorbs and attenuates waves propagating outward from the domain, without any significant reflection of the waves back into the bounded domain. The layer cannot support any static displacement.
2. It is assumed the material in the bounded domain near the layer is, or behaves like, an isotropic linear elastic material. The material properties of the layer should be set to the corresponding properties of this material.
3. The layer should form a cuboid box around the bounded domain, with the axes of the box aligned with the coordinate axes. Various faces of this box may be open, as required by the geometry of the problem, e.g., for a half-space problem, the "top" of the box should be open.

4. Internally, LS-DYNA will partition the entire PML into regions which form the "faces", "edges" and "corners" of the above cuboid box, and generate a new material for each region. This partitioning will be visible in the d3plot file. The user may safely ignore this partitioning.
5. The layer should have 5-10 elements through its depth. Typically, 5-6 elements are sufficient if the excitation source is reasonably distant from the layer, and 8-10 elements if it is close. The size of the elements should be similar to that of elements in the bounded domain near the layer, and should be small enough to sufficiently discretize all significant wavelengths in the problem.
6. The nodes on the outer boundary of the layer should be fully constrained.
7. The stress and strain values reported by this material do not have any physical significance.

***MAT_PML_ELASTIC_FLUID**

This is Material Type 230_FLUID. This is a perfectly-matched layer (PML) material with a pressure fluid constitutive law, to be used in a wave-absorbing layer adjacent to a fluid material (*MAT_ELASTIC_FLUID) in order to simulate wave propagation in an unbounded fluid medium. See the Remarks sections of *MAT_PML_ELASTIC (*MAT_230) and *MAT_ELASTIC_FLUID (*MAT_001_FLUID) for further details.

Card	1	2	3	4	5	6	7	8
Variable	MID	RO	K	VC				
Type	A8	F	F	F				
Default	none	none	none	none				

VARIABLE**DESCRIPTION**

MID	Material identification. A unique number or label not exceeding 8 characters must be specified.
RO	Mass density
K	Bulk modulus
VC	Tensor viscosity coefficient

***MAT_PML_ACOUSTIC**

This is Material Type 231. This is a perfectly-matched layer (PML) material — an absorbing layer material used to simulate wave propagation in an unbounded acoustic medium — and can be used only with the acoustic pressure element formulation (element type 14). This material implements the 3D version of the Basu-Chopra PML for anti-plane motion [Basu and Chopra (2003,2004), Basu (2009)].

Card	1	2	3	4	5	6	7	8
Variable	MID	RO	C					
Type	A8	F	F					
Default	none	none	none					

VARIABLE**DESCRIPTION**

MID	Material identification. A unique number or label not exceeding 8 characters must be specified.
RO	Mass density
C	Sound speed

Remarks:

1. A layer of this material may be placed at a boundary of a bounded domain to simulate unboundedness of the domain at that boundary: the layer absorbs and attenuates waves propagating outward from the domain, without any significant reflection of the waves back into the bounded domain. The layer cannot support any hydrostatic pressure.
2. It is assumed the material in the bounded domain near the layer is an acoustic material. The material properties of the layer should be set to the corresponding properties of this material.
3. The layer should form a cuboid box around the bounded domain, with the axes of the box aligned with the coordinate axes. Various faces of this box may be open, as required by the geometry of the problem, e.g., for a half-space problem, the “top” of the box should be open.
4. Internally, LS-DYNA will partition the entire PML into regions which form the “faces”, “edges” and “corners” of the above cuboid box, and generate a new mate-

rial for each region. This partitioning will be visible in the d3plot file. The user may safely ignore this partitioning.

5. The layer should have 5-10 elements through its depth. Typically, 5-6 elements are sufficient if the excitation source is reasonably distant from the layer, and 8-10 elements if it is close. The size of the elements should be similar to that of elements in the bounded domain near the layer, and should be small enough to sufficiently discretize all significant wavelengths in the problem.
6. The nodes on the outer boundary of the layer should be fully constrained.
7. The pressure values reported by this material do not have any physical significance.

***MAT_BIOT_HYSTERETIC**

This is Material Type 232. This is a Biot linear hysteretic material, to be used for modeling the nearly-frequency-independent viscoelastic behaviour of soils subjected to cyclic loading, e.g. in soil-structure interaction analysis [Spanos and Tsavachidis (2001), Makris and Zhang (2000), Muscolini, Palmeri and Ricciardelli (2005)]. The hysteretic damping coefficient for the model is computed from a prescribed damping ratio by calibrating with an equivalent viscous damping model for a single-degree-of-freedom system. The damping increases the stiffness of the model and thus reduces the computed time-step size.

Card	1	2	3	4	5	6	7	8
Variable	MID	RO	E	PR	ZT	FD		
Type	A8	F	F	F	F	F		
Default	none	none	none	none	0.0	3.25		

VARIABLE**DESCRIPTION**

MID	Material identification. A unique number or label not exceeding 8 characters must be specified.
RO	Mass density.
E	Young's modulus.
PR	Poisson's ratio.
ZT	Damping ratio
FD	Dominant excitation frequency in Hz

Remarks:

1. The stress is computed as a function of the strain rate as

$$\sigma(t) = \int_0^t C_R(t - \tau) \dot{\epsilon}(\tau) d\tau$$

where

$$C_R(t) = C \left[1 + \frac{2\eta}{\pi} E_1(\beta t) \right]$$

with C being the elastic isotropic constitutive tensor, η the hysteretic damping factor, and $\beta = 2\pi f_d/10$, where f_d is the dominant excitation frequency in Hz. The function E_1 is given by

$$E_1(s) = \int_s^{\infty} \frac{e^{-\zeta}}{\zeta} d\zeta$$

For efficient implementation, this function is approximated by a 5-term Prony series as

$$E_1(s) \approx \sum_{k=1}^5 b_k e^{a_k s}$$

such that $b_k > 0$.

2. The hysteretic damping factor η is obtained from the prescribed damping ratio ζ as

$$\eta = \pi\zeta/\text{atan}(10) = 2.14\zeta$$

by assuming that, for a single degree-of-freedom system, the energy dissipated per cycle by the hysteretic material is the same as that by a viscous damper, if the excitation frequency matches the natural frequency of the system.

3. The consistent Young's modulus for this model is given by

$$E_c = E \left[1 + \frac{2\eta}{\pi} g \right]$$

where

$$g = \sum_{k=1}^5 b_k \frac{1}{a_k \beta \Delta t_n} [\exp(a_k \beta \Delta t_n) - 1]$$

Because $g > 0$, the computed element time-step size is smaller than that for the corresponding elastic element. Furthermore, the time-step size computed at any time depends on the previous time-step size. It can be demonstrated that the new computed time-step size stays within a narrow range of the previous time-step size, and for a uniform mesh, converges to a constant value. For $f_d = 3.25\text{Hz}$ and $\zeta = 0.05$, the percentage decrease in time-step size can be expected to be about 12-15% for initial time-step sizes of less than 0.02 secs, and about 7-10% for initial time-step sizes larger than 0.02 secs.

4. The default value of the dominant frequency is chosen to be valid for earthquake excitation.

***MAT_CAZACU_BARLAT**

This is Material Type 233. This material model is for Hexagonal Closed Packet (HCP) metals and is based on the work by Cazacu et al. (2006). This model is capable of describing the yielding asymmetry between tension and compression for such materials. Moreover, a parameter fit is optional and can be used to find the material parameters that describe the experimental yield stresses. The experimental data that the user should supply consists of yield stresses for tension and compression in the 00 direction, tension in the 45 and the 90 directions, and a biaxial tension test.

Card 1	1	2	3	4	5	6	7	8
Variable	MID	R0	E	PR	HR	P1	P2	ITER
Type	A8	F	F	F	F	F	F	F

Card 2	1	2	3	4	5	6	7	8
Variable	A	C11	C22	C33	LCID	E0	K	P3
Type	F	F	F	F	I	F	F	F

Card 3	1	2	3	4	5	6	7	8
Variable	AOPT				C12	C13	C23	C44
Type	F				F	F	F	F

Card 4	1	2	3	4	5	6	7	8
Variable				A1	A2	A3		
Type				F	F	F		

Card 5	1	2	3	4	5	6	7	8
Variable	V1	V2	V3	D1	D2	D3	BETA	FIT
Type	F	F	F	F	F	F	F	I

VARIABLE**DESCRIPTION**

MID	Material Identification number.
RO	Constant Mass density.
E	Young's modulus E.GT.0.0: constant value E.LT.0.0: load curve ID (-E) which defines the Young's modulus as a function of plastic strain.
PR	Poisson's ratio
HR	Hardening rules: HR.EQ.1.0: linear hardening (default) HR.EQ.2.0: exponential hardening (Swift) HR.EQ.3.0: load curve HR.EQ.4.0: exponential hardening (Voce) HR.EQ.5.0: exponential hardening (Gosh) HR.EQ.6.0: exponential hardening (Hocken-Sherby)
P1	Material parameter: HR.EQ.1.0: tangent modulus HR.EQ.2.0: q, coefficient for exponential hardening law (Swift) HR.EQ.4.0: a, coefficient for exponential hardening law (Voce) HR.EQ.5.0: q, coefficient for exponential hardening law (Gosh) HR.EQ.6.0: a, coefficient for exponential hardening law (Hockett-Sherby)

VARIABLE	DESCRIPTION
P2	Material parameter: HR.EQ.1.0: yield stress for the linear hardening law HR.EQ.2.0: n, coefficient for (Swift) exponential hardening HR.EQ.4.0: c, coefficient for exponential hardening law (Voce) HR.EQ.5.0: n, coefficient for exponential hardening law (Gosh) HR.EQ.6.0: c, coefficient for exponential hardening law (Hockett-Sherby)
ITER	Iteration flag for speed: ITER.EQ.0.0: fully iterative ITER.EQ.1.0: fixed at three iterations. Generally, ITER = 0.0 is recommended. However, ITER = 1.0 is faster and may give acceptable results in most problems.
A	Exponent in Cazacu-Barlat's orthotropic yield surface ($A > 1$)
C11	Material parameter (see card 5 pos. 8): FIT.EQ.1.0 or EQ.2.0: yield stress for tension in the 00 direction FIT.EQ.0.0: material parameter c11
C22	Material parameter (see card 5 pos.8): FIT.EQ.1.0 or EQ.2.0: yield stress for tension in the 45 direction FIT.EQ.0.0: material parameter c22
C33	Material parameter (see card 5 pos.8): FIT.EQ.1.0 or EQ.2.0: yield stress for tension in the 90 direction FIT.EQ.0.0: material parameter c33
LCID	Load curve ID for the hardening law (HR.EQ.3.0)

VARIABLE	DESCRIPTION
E0	Material parameter: HR.EQ.2.0: initial yield stress for exponential hardening law (Swift) (default = 0.0) HR.EQ.4.0: b, coefficient for exponential hardening (Voce) HR.EQ.5.0: initial yield stress for exponential hardening (Gosh), Default = 0.0 HR.EQ.6.0: b, coefficient for exponential hardening law (Hocket-Sherby)
K	Material parameter (see card 5 pos.8): FIT.EQ.1.0 or EQ.2.0: yield stress for compression in the 00 direction FIT.EQ.0.0: material parameter (-1 < k<1)
P3	Material parameter: HR.EQ.5.0: p, coefficient for exponential hardening (Gosh) HR.EQ.6.0: n, exponent for exponential hardening law (Hocket-Sherby)

VARIABLE	DESCRIPTION
AOPT	<p>Material axes option (see MAT_OPTIONTROPIC_ELASTIC for more complete description).</p> <p>AOPT.EQ.0.0: locally orthotropic with material axes determined by element nodes 1, 2 and 4, as with *DEFINE_COORDINATE_NODES, and then rotated about the shell element normal by the angle BETA.</p> <p>AOPT.EQ.2.0: globally orthotropic with material axes determined by vectors defined below, as with *DEFINED_COORDINATE_VECTOR.</p> <p>AOPT.EQ.3.0: locally orthotropic material axes determined by rotating the material axes about the element normal by an angle BETA, from a line in the plane of the element defined by the cross product of the vector V with the element normal.</p> <p>AOPT.LT.0.0: the absolute value of AOPT is coordinate system ID (CID on *DEFINE_COORDINATE_NODES, *DEFINE_COORDINATE_SYSTEM, or *DEFINED_COORDINATE_VECTOR). Available with the R3 release of 971 and later.</p>
C12	Material parameter. If parameter identification (FIT = 1.0) is turned on C12 is not used.
C13	Material parameter. If parameter identification (FIT = 1.0) is turned on C13 = 0.0
C23	Material parameter. If parameter identification (FIT = 1.0) is turned on C23 = 0.0
C44	<p>Material parameter (see card 5 pos.8)</p> <p>FIT.EQ.1.0 or EQ.2.0: yield stress for the balanced biaxial tension test.</p> <p>FIT.EQ.0.0: material parameter c44</p>
A1 - A3	Components of vector a for AOPT = 2.0
V1 - V3	Components of vector v for AOPT = 3.0
D1 - D3	Components of vector d for AOPT = 2.0

VARIABLE	DESCRIPTION
BETA	Material angle in degrees for AOPT = 0 and 3. NOTE, may be overridden on the element card, see *ELEMENT_SHELL_BETA
FIT	Flag for parameter identification algorithm: <ul style="list-style-type: none"> FIT.EQ.0.0: No parameter identification routine is used. The variables K, C11, C22, C33, C44, C12, C13 and C23 are interpreted as material parameters. FIT.EQ.1.0: Parameter fit is used. The variables C11, C22, C33, C44 and K are interpreted as yield stresses in the 00, 45, 90 degree directions, the balanced biaxial tension and the 00 degree compression, respectively. NOTE: it is recommended to always check the d3hsp file to see the fitted parameters before complex jobs are submitted. FIT.EQ.2.0: Same as EQ.1.0 but also produce contour plots of the yield surface. For each material three LS-PrePost ready xy-data files are created; Contour1_x, Contour2_x and Contour3_x where x equal the material numbers.

Remarks:

The material model #233 (MAT_CAZACU_BARLAT) is aimed for modeling materials with strength differential and orthotropic behavior under plane stress. The yield condition includes a parameter k that describes the asymmetry between yield in tension and compression. Moreover, to include the anisotropic behavior the stress deviator \mathbf{S} undergoes a linear transformation. The principal values of the Cauchy stress deviator are substituted with the principal values of the transformed tensor \mathbf{Z} , which is represented as a vector field, defined as:

$$\mathbf{Z} = \mathbf{C}\mathbf{S} \quad (233.1)$$

where \mathbf{S} is the field comprised of the four stresses deviator components $S_I = (s_{11}, s_{22}, s_{33}, s_{12})$,

$$\mathbf{s} = \boldsymbol{\sigma} - \frac{1}{3} \text{tr}(\boldsymbol{\sigma})\boldsymbol{\delta},$$

where $\text{tr}(\boldsymbol{\sigma})$ is the trace of the Cauchy stress tensor and $\boldsymbol{\delta}$ is the Kronecker delta. For the 2D plane stress condition, the orthotropic condition gives 7 independent coefficients. The tensor \mathbf{C} is represented by the 4x4 matrix

$$C_{IJ} = \begin{pmatrix} c_{11} & c_{12} & c_{13} & \\ c_{12} & c_{22} & c_{23} & \\ c_{13} & c_{23} & c_{33} & \\ & & & c_{44} \end{pmatrix}.$$

The principal values of \mathbf{Z} are denoted $\Sigma_1, \Sigma_2, \Sigma_3$ and are given as the eigenvalues to the matrix composed by the components $\Sigma_{xx}, \Sigma_{yy}, \Sigma_{zz}, \Sigma_{xy}$ through

$$\Sigma_1 = \frac{1}{2} \left(\Sigma_{xx} + \Sigma_{yy} + \sqrt{(\Sigma_{xx} - \Sigma_{yy})^2 + 4\Sigma_{xy}^2} \right),$$

$$\Sigma_2 = \frac{1}{2} \left(\Sigma_{xx} + \Sigma_{yy} - \sqrt{(\Sigma_{xx} - \Sigma_{yy})^2 + 4\Sigma_{xy}^2} \right),$$

$$\Sigma_3 = \Sigma_{zz}$$

where

$$3\Sigma_{xx} = (2c_{11} - c_{12} - c_{13})\sigma_{xx} + (-c_{11} + 2c_{12} - c_{13})\sigma_{yy},$$

$$3\Sigma_{yy} = (2c_{12} - c_{22} - c_{23})\sigma_{xx} + (-c_{12} + 2c_{22} - c_{23})\sigma_{yy},$$

$$3\Sigma_{zz} = (2c_{13} - c_{23} - c_{33})\sigma_{xx} + (-c_{13} + 2c_{23} - c_{33})\sigma_{yy},$$

$$\Sigma_{xy} = c_{44}\sigma_{12}$$

Note that the symmetry of Σ_{xy} follows from the symmetry of the Cauchy stress tensor.

The yield condition is written on the following form:

$$f(\Sigma, k, \varepsilon_{ep}) = \sigma_{\text{eff}}(\Sigma_1, \Sigma_2, \Sigma_3, k) - \sigma_y(\varepsilon_{ep}) \leq 0 \quad (233.2)$$

where $\sigma_y(\varepsilon_{ep})$ is a function representing the current yield stress dependent on current effective plastic strain and k is the asymmetric parameter for yield in compression and tension. The effective stress σ_{eff} is given by

$$\sigma_{\text{eff}} = [(|\Sigma_1| - k\Sigma_1)^a + (|\Sigma_2| - k\Sigma_2)^a + (|\Sigma_3| - k\Sigma_3)^a]^{1/a} \quad (233.3)$$

where $k \in [-1, 1], a \geq 1$. Now, let σ_{00}^T and σ_{00}^C represent the yield stress along the rolling (00 degree) direction in tension and compression, respectively. Furthermore let σ_{45}^T and σ_{90}^T represent the yield stresses in the 45 and the 90 degree directions, and last let σ_B^T be the balanced biaxial yield stress in tension. Following Cazacu et al. (2006) the yield stresses can easily be derived.

To simplify the equations it is preferable to make the following definitions:

$$\begin{aligned}\Phi_1 &= \frac{1}{3}(2c_{11} - c_{12} - c_{13}) & \Psi_1 &= \frac{1}{3}(-c_{11} + 2c_{12} - c_{13}) \\ \Phi_2 &= \frac{1}{3}(2c_{12} - c_{22} - c_{23}) \quad \text{and} & \Psi_2 &= \frac{1}{3}(-c_{12} + 2c_{22} - c_{23}) \\ \Phi_3 &= \frac{1}{3}(2c_{13} - c_{23} - c_{33}) & \Psi_3 &= \frac{1}{3}(-c_{13} + 2c_{23} - c_{33})\end{aligned}$$

The yield stresses can now be written as:

1. In the 00 degree direction:

$$\begin{aligned}\sigma_{00}^T &= \left[\frac{(\sigma_{eff})^a}{(|\Phi_1| - k\Phi_1)^a + (|\Phi_2| - k\Phi_2)^a + (|\Phi_3| - k\Phi_3)^a} \right]^{1/a}, \\ \sigma_{00}^C &= \left[\frac{(\sigma_{eff})^a}{(|\Phi_1| + k\Phi_1)^a + (|\Phi_2| + k\Phi_2)^a + (|\Phi_3| + k\Phi_3)^a} \right]^{1/a}\end{aligned} \quad (233.4)$$

2. In the 45 degree direction:

$$\sigma_{45}^T = \left[\frac{(\sigma_{eff})^a}{(|\Lambda_1| - k\Lambda_1)^a + (|\Lambda_2| - k\Lambda_2)^a + (|\Lambda_3| - k\Lambda_3)^a} \right]^{1/a} \quad (233.5)$$

where

$$\begin{aligned}\Lambda_1 &= \frac{1}{4} \left[\Phi_1 + \Phi_2 + \Psi_1 + \Psi_2 + \sqrt{(\Phi_1 + \Psi_1 - \Phi_2 - \Psi_2)^2 + 4c_{44}^2} \right], \\ \Lambda_2 &= \frac{1}{4} \left[\Phi_1 + \Phi_2 + \Psi_1 + \Psi_2 - \sqrt{(\Phi_1 + \Psi_1 - \Phi_2 - \Psi_2)^2 + 4c_{44}^2} \right], \\ \Lambda_3 &= \frac{1}{2} [\Phi_3 + \Psi_3].\end{aligned}$$

3. In the 90 degree direction:

$$\sigma_{90}^T = \left[\frac{(\sigma_{eff})^a}{(|\Psi_1| - k\Psi_1)^a + (|\Psi_2| - k\Psi_2)^a + (|\Psi_3| - k\Psi_3)^a} \right]^{1/a} \quad (233.6)$$

4. In the balanced biaxial yield occurs when both σ_{xx} and σ_{yy} are equal to:

$$\sigma_B^T = \left[\frac{(\sigma_{eff})^a}{(|\Omega_1| - k\Omega_1)^a + (|\Omega_2| - k\Omega_2)^a + (|\Omega_3| - k\Omega_3)^a} \right]^{1/a} \quad (233.7)$$

where

$$\Omega_1 = \frac{1}{3}(c_{11} + c_{12} - 2c_{13})$$

$$\Omega_2 = \frac{1}{3}(c_{12} + c_{22} - 2c_{23})$$

$$\Omega_3 = \frac{1}{3}(c_{13} + c_{23} - 2c_{33})$$

Hardening laws:

The implemented hardening laws are the following:

1. The Swift hardening law
2. The Voce hardening law
3. The Gosh hardening law
4. The Hocket-Sherby hardening law
5. A loading curve, where the yield stress is given as a function of the effective plastic strain

The Swift's hardening law can be written

$$\sigma_y(\varepsilon_{ep}) = q(\varepsilon_0 + \varepsilon_{ep})^n$$

where q and n are material parameters.

The Voce's equation says that the yield stress can be written in the following form

$$\sigma_y(\varepsilon_{ep}) = a - be^{-c\varepsilon_{ep}}$$

where a , b and c are material parameters. The Gosh's equation is similar to Swift's equation. They only differ by a constant

$$\sigma_y(\varepsilon_{ep}) = q(\varepsilon_0 + \varepsilon_{ep})^n - p$$

where q , ε_0 , n and p are material constants. The Hocket-Sherby equation resemble the Voce's equation, but with an additional parameter added

$$\sigma_y(\varepsilon_{ep}) = a - be^{-c\varepsilon_{ep}^n}$$

where a , b , c and n are material parameters.

Constitutive relation and material stiffness:

The classical elastic constitutive equation for linear deformations is the well-known Hooke's law. This relation written in a rate formulation is given by

$$\dot{\sigma} = \mathbf{D}\dot{\varepsilon}_e \quad (233.8)$$

where ε_e is the elastic strain and \mathbf{D} is the constitutive matrix. An over imposed dot indicates differentiation respect to time. Introducing the total strain ε and the plastic strain ε_p , Eq. (233.8) is classically rewritten as

$$\dot{\sigma} = \mathbf{D}(\dot{\varepsilon} - \dot{\varepsilon}_p) \quad (233.9)$$

where

$$\mathbf{D} = \frac{E}{1-\nu^2} \begin{pmatrix} 1 & \nu & & & \\ \nu & 1 & & & \\ & & \frac{1-\nu}{2} & & \\ & & & \frac{1-\nu}{2} & \\ & & & & \frac{1-\nu}{2} \end{pmatrix} \text{ and } (\dot{\varepsilon} - \dot{\varepsilon}_p) = \begin{pmatrix} \dot{\varepsilon}_{11} - (\dot{\varepsilon}_p)_{11} \\ \dot{\varepsilon}_{22} - (\dot{\varepsilon}_p)_{22} \\ 2[\dot{\varepsilon}_{12} - (\dot{\varepsilon}_p)_{12}] \\ 2[\dot{\varepsilon}_{13} - (\dot{\varepsilon}_p)_{13}] \\ 2[\dot{\varepsilon}_{23} - (\dot{\varepsilon}_p)_{23}] \end{pmatrix}.$$

The parameters E and ν are the Young's modulus and Poisson's ratio, respectively.

The material stiffness \mathbf{D}_p that is needed for e.g., implicit analysis can be calculated from (233.9) as

$$\mathbf{D}_p = \frac{\partial \dot{\sigma}}{\partial \dot{\varepsilon}}$$

The associative flow rule for the plastic strain is usually written

$$\dot{\varepsilon}_p = \dot{\lambda} \frac{\partial f}{\partial \sigma} \quad (233.10)$$

and the consistency condition reads

$$\frac{df}{d\sigma} \dot{\sigma} + \frac{df}{d\varepsilon_{ep}} \dot{\varepsilon}_{ep} = 0. \quad (233.11)$$

Note that the centralized "dot" means scalar product between two vectors. Using standard calculus one easily derives from (1.9), (1.10) and (1.11) an expression for the stress rate

$$\dot{\sigma} = \left[\mathbf{D} - \frac{\left(\mathbf{D} \frac{df}{d\sigma} \right) \cdot \left(\mathbf{D} \frac{df}{d\sigma} \right)}{\frac{df}{d\sigma} \cdot \left(\mathbf{D} \frac{df}{d\sigma} \right) - \frac{df}{d\varepsilon_{ep}}} \right] \dot{\varepsilon} \quad (233.12)$$

That means that the material stiffness used for implicit analysis is given by

$$\mathbf{D}_p = \mathbf{D} - \frac{\left(\mathbf{D} \frac{df}{d\sigma} \right) \cdot \left(\mathbf{D} \frac{df}{d\sigma} \right)}{\frac{df}{d\sigma} \cdot \left(\mathbf{D} \frac{df}{d\sigma} \right) - \frac{df}{d\varepsilon_{ep}}}. \quad (233.13)$$

To be able to do a stress update we need to calculate the tangent stiffness and the derivative with respect to the corresponding hardening law.

When a suitable hardening law has been chosen the corresponding derivative is simple and will be left out from this document. However, the stress gradient of the yield surface is more complicated and will be outlined here.

$$\begin{aligned} \frac{df}{d\sigma_{11}} = & \frac{df}{d\Sigma_3} \frac{1}{2} \frac{df}{d\Sigma_1} \left[\left(1 + \frac{\Sigma_{xx} - \Sigma_{yy}}{\sqrt{\Sigma_T}} \right) \Phi_1 + \left(1 - \frac{\Sigma_{xx} - \Sigma_{yy}}{\sqrt{\Sigma_T}} \right) \Phi_2 \right] \\ & + \frac{1}{2} \frac{df}{d\Sigma_2} \left[\left(1 - \frac{\Sigma_{xx} - \Sigma_{yy}}{\sqrt{\Sigma_T}} \right) \Phi_1 + \left(1 + \frac{\Sigma_{xx} - \Sigma_{yy}}{\sqrt{\Sigma_T}} \right) \Phi_2 \right] + \Phi_3 \end{aligned} \quad (233.14)$$

$$\begin{aligned} \frac{df}{d\sigma_{22}} = & \frac{1}{2} \frac{df}{d\Sigma_1} \left[\left(1 + \frac{\Sigma_{xx} - \Sigma_{yy}}{\sqrt{\Sigma_T}} \right) \Psi_1 + \left(1 - \frac{\Sigma_{xx} - \Sigma_{yy}}{\sqrt{\Sigma_T}} \right) \Psi_2 \right] \\ & + \frac{1}{2} \frac{df}{d\Sigma_2} \left[\left(1 - \frac{\Sigma_{xx} - \Sigma_{yy}}{\sqrt{\Sigma_T}} \right) \Psi_1 + \left(1 + \frac{\Sigma_{xx} - \Sigma_{yy}}{\sqrt{\Sigma_T}} \right) \Psi_2 \right] + \frac{df}{d\Sigma_3} \Psi_3 \end{aligned} \quad (233.15)$$

and the derivative with respect to the shear stress component is

$$\frac{df}{d\sigma_{12}} = c_{44} \frac{2\Sigma_{xy}}{\sqrt{\Sigma_T}} \left(\frac{df}{d\Sigma_1} - \frac{df}{d\Sigma_2} \right) \quad (233.16)$$

where

$$\Sigma_T = (\Sigma_{xx} - \Sigma_{yy})^2 + 4\Sigma_{xy}^2 \quad (233.17)$$

and

$$\frac{df}{d\Sigma_i} = f(\Sigma, k, \varepsilon_{ep})^{\frac{1}{a}-1} (|\Sigma_i| - k\Sigma_i)^{a-1} (\text{sgn}(\Sigma_i) - k) \quad \text{for } i = 1, 2, 3 \quad (233.18)$$

Implementation:

Assume that the stress and strain is known at time t^n . A trial stress $\tilde{\sigma}^{n+1}$ at time t^{n+1} is calculated by assuming a pure elastic deformation, i.e.,

$$\tilde{\sigma}^{n+1} = \sigma^n + \mathbf{D}(\boldsymbol{\varepsilon}^{n+1} - \boldsymbol{\varepsilon}^n) \quad (233.19)$$

Now, if $f(\Sigma, k, \varepsilon_{ep}) \leq 0$ the deformation is pure elastic and the new stress and plastic strain are determined as

$$\begin{aligned} \sigma^{n+1} &= \tilde{\sigma}^{n+1} \\ \varepsilon_{ep}^{n+1} &= \varepsilon_{ep}^n \end{aligned} \quad (233.20)$$

and the thickness strain increment is given by

$$\Delta\varepsilon_{33} = \varepsilon_{33}^{n+1} - \varepsilon_{33}^n = -\frac{\nu}{1-\nu}(\Delta\varepsilon_{11} + \Delta\varepsilon_{22}) \quad (233.21)$$

If the deformation is not pure elastic the stress is not inside the yield surface and a plastic iterative procedure must take place.

1. Set $m = 0$, $\sigma_{(0)}^{n+1} = \tilde{\sigma}^{n+1}$, $\varepsilon_{\text{ep}(0)}^{n+1} = \varepsilon_{\text{ep}}^n$ and $\Delta\varepsilon_{11}^{p(0)} = \Delta\varepsilon_{22}^{p(0)} = 0$
2. Determine the plastic multiplier as

$$\Delta\lambda = \frac{f(\sigma_{(m)}^{n+1}, \varepsilon_{\text{ep}(m)}^{n+1})}{\frac{df}{d\sigma}(\sigma_{(m)}^{n+1}) \cdot \mathbf{D} \frac{df}{d\sigma}(\sigma_{(m)}^{n+1}) - \frac{df}{d\varepsilon_{\text{ep}}}(\varepsilon_{\text{ep}(m)}^{n+1})} \quad (233.21)$$

3. Perform a plastic corrector step: $\sigma_{(m+1)}^{n+1} = \sigma_{(m)}^{n+1} - \Delta\lambda \mathbf{D} \frac{df}{d\sigma}(\sigma_{(m)}^{n+1})$ and find the increments in plastic strain according to

$$\begin{aligned} \varepsilon_{\text{ep}(m+1)}^{n+1} &= \varepsilon_{\text{ep}(m)}^{n+1} + \Delta\lambda \\ \Delta\varepsilon_{11}^{p(n+1)} &= \Delta\varepsilon_{11}^{p(n)} + \Delta\lambda \frac{df}{d\sigma_{11}}(\sigma_{(m)}^{n+1}) \\ \Delta\varepsilon_{22}^{p(n+1)} &= \Delta\varepsilon_{22}^{p(n)} + \Delta\lambda \frac{df}{d\sigma_{22}}(\sigma_{(m)}^{n+1}) \end{aligned} \quad (233.22)$$

4. If $|f(\sigma_{(m+1)}^{n+1}, \varepsilon_{\text{ep}}^n)| < \text{tol}$ or $m = m_{\text{max}}$; stop and set

$$\begin{aligned} \sigma^{n+1} &= \sigma_{(m+1)}^{n+1}, \varepsilon_{\text{ep}}^{n+1} = \varepsilon_{\text{ep}(m+1)}^{n+1}, \\ \Delta\varepsilon_{11}^p &= \Delta\varepsilon_{11}^{p(m+1)}, \Delta\varepsilon_{22}^p = \Delta\varepsilon_{22}^{p(m+1)}, \end{aligned} \quad (233.23)$$

otherwise set $m = m + 1$ and return to 2.

The thickness strain increment is for plastic yield calculated as

$$\Delta\varepsilon_{33} = -\frac{1}{1-\nu}(\Delta\varepsilon_{11} + \Delta\varepsilon_{22}) - \left(1 - \frac{\nu}{1-\nu}\right)(\Delta\varepsilon_{11}^p + \Delta\varepsilon_{22}^p) \quad (233.24)$$

***MAT_VISCOELASTIC_LOOSE_FABRIC**

This is Material Type 234 developed by Ivanov and Tabiei [2004]. The model is a mechanism incorporating the crimping of the fibers as well as the trellising with reorientation of the yarns and the locking phenomenon observed in loose fabric. The equilibrium of the mechanism allows the straightening of the fibers depending on the fiber tension. The contact force at the fiber cross over point determines the rotational friction dissipating a part of the impact energy. The stress-strain relationship is viscoelastic based on a three-element model. The failure of the fibers is strain rate dependent. *DAMPING_MASS is recommended to be used in conjunction with this material model. This material is valid for modeling the elastic and viscoelastic response of loose fabric used in body armor, blade containments, and airbags.

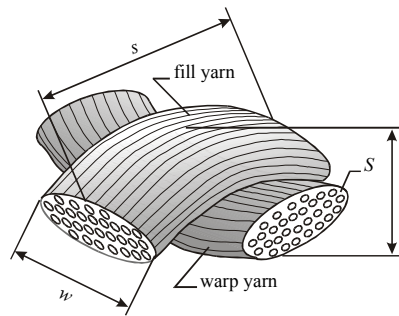

Figure 2-114. Representative Volume Cell (RVC) of the model

Card 1	1	2	3	4	5	6	7	8
Variable	MID	R0	E1	E2	G12	EU	THL	THI
Type	A8	F	F	F	F	F	F	F

Card 2	1	2	3	4	5	6	7	8
Variable	TA	W	s	T	H	S	EKA	EUA
Type	F	F	F	F	F	F	F	F

Card 3	1	2	3	4	5	6	7	8
Variable	VMB	C	G23	EKB	AOPT			
Type	F	F	F	F	F			

Card 4	1	2	3	4	5	6	7	8
Variable	Not used	Not used	Not used	A1	A2	A3		
Type				F	F	F		

Card 5	1	2	3	4	5	6	7	8
Variable	V1	V2	V3	D1	D2	D3		
Type	F	F	F	F	F	F		

VARIABLE**DESCRIPTION**

MID	Material identification. A unique number or label not exceeding 8 characters must be specified.
RO	Mass density.
E1	E_1 , Young's modulus in the yarn axial-direction.
E2	E_2 , Young's modulus in the yarn transverse-direction.
G12	G_{12} , Shear modulus of the yarns.
EU	Ultimate strain at failure.
THL	Yarn locking angle.
THI	Initial brade angle.
TA	Transition angle to locking.
W	Fiber width.

VARIABLE	DESCRIPTION
S	Span between the fibers.
T	Real fiber thickness.
H	Effective fiber thickness.
S	Fiber cross-sectional area.
EKA	Elastic constant of element "a".
EUA	Ultimate strain of element "a".
VMB	Damping coefficient of element "b".
C	Coefficient of friction between the fibers.
G23	transverse shear modulus.
Ekb	Elastic constant of element "b"
AOPT	Material axes option (see MAT_OPTIONTROPIC_ELASTIC for more complete description). AOPT.EQ.0.0: locally orthotropic with material axes determined by element nodes 1, 2 and 4, as with *DEFINE_COORDINATE_NODES. AOPT.EQ.2.0: globally orthotropic with material axes determined by vectors defined below, as with *DEFINED_COORDINATE_VECTOR. AOPT.EQ.3.0: locally orthotropic material axes defined by the cross product of the vector V with the element normal. AOPT.LT.0.0: the absolute value of AOPT is coordinate system ID (CID on *DEFINE_COORDINATE_NODES, *DEFINE_COORDINATE_SYSTEM, or *DEFINED_COORDINATE_VECTOR). Available with the R3 release of 971 and later.

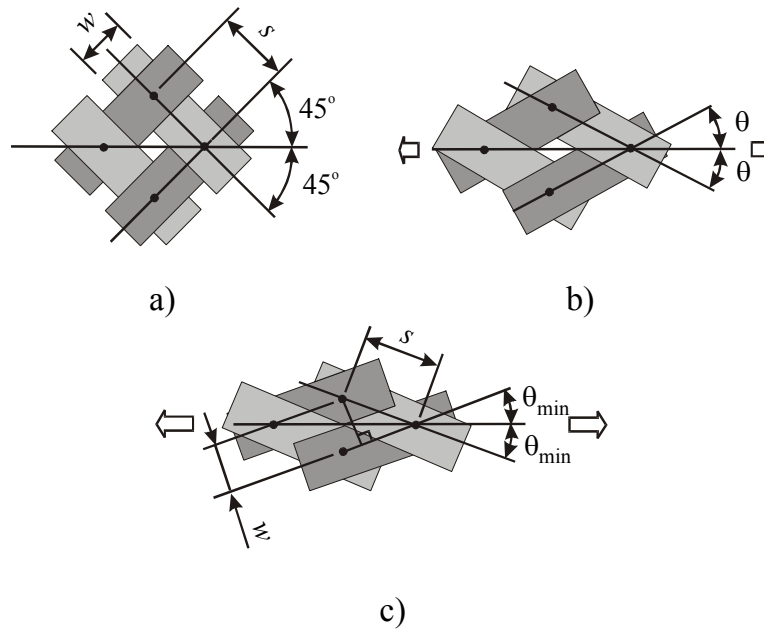

Figure 2-115. Plain woven fabric as trellis mechanism: a) initial state; b) slightly stretched in bias direction; c) stretched to locking.

Remarks:

The parameters of the Representative Volume Cell (RVC) are: the yarn span, s , the fabric thickness, t , the yarn width, w , and the yarn cross-sectional area, A . The initially orthogonal yarns (see Fig. 2-115a) are free to rotate (see Fig. 2-115b) up to some angle and after that the lateral contact between the yarns causes the locking of the trellis mechanism and the packing of the yarns (see Fig. 2-115c). The minimum braid angle, θ_{\min} , can be calculated from the geometry and the architecture of the fabric material having the yarn width, w , and the span between the yarns, s :

$$\sin(2\theta_{\min}) = \frac{w}{s}$$

The other constrain angles as the locking range angle, θ_{lock} , and the maximum braid angle, θ_{\max} , (see Fig) are easy to be determined then:

$$\theta_{\text{lock}} = 45^\circ - \theta_{\min} , \quad \theta_{\max} = 45^\circ + \theta_{\text{lock}}$$

The material behavior of the yarn can be simply described by a combination of one Maxwell element without the dashpot and one Kelvin-Voigt element. The 1-D model of viscoelasticity is shown in [figure 2-116](#). The differential equation of viscoelasticity of the yarns can be derived from the model equilibrium as in the following equation:

$$(K_a + K_b)\sigma + \mu_b \dot{\sigma} = K_a K_b \varepsilon + \mu_b K_a \dot{\varepsilon}$$

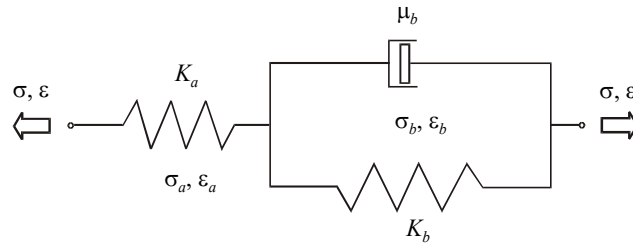

Figure 2-116. Three-element viscoelasticity model

The input parameters for the viscoelasticity model of the material are only the static Young’s modulus E_1 , the Hookian spring coefficient (EKA) K_a , the viscosity coefficient (VMB) μ_b , the static ultimate strain (EU) ε_{\max} , and the Hookian spring ultimate strain (EUA) $\varepsilon_{b\max}$. The other parameters can be obtained as follows:

$$K_b = \frac{K_a E_1}{K_a - E_1}$$

$$\varepsilon_{b\max} = \frac{K_a - E_1}{K_a} \varepsilon_{\max}$$

Applying the Eq. (18) for the fill and the warp yarns, we obtain the stress increments in the yarns, $\Delta\sigma_f$ and $\Delta\sigma_w$. The stress in the yarns is updated for the next time step:

$$\sigma_f^{(n+1)} = \sigma_f^{(n)} + \Delta\sigma_f^{(n)} \quad , \quad \sigma_w^{(n+1)} = \sigma_w^{(n)} + \Delta\sigma_w^{(n)}$$

We can imagine that the RVC is smeared to the parallelepiped in order to transform the stress acting on the yarn cross-section to the stress acting on the element wall. The thickness of the membrane shell element used should be equal to the effective thickness, t_e , that can be found by dividing the areal density of the fabric by its mass density. The in-plane stress components acting on the RVC walls in the material direction of the yarns are calculated as follows for the fill and warp directions:

$$\sigma_{f11}^{(n+1)} = \frac{2\sigma_f^{(n+1)} S}{s t_e} \quad , \quad \sigma_{w11}^{(n+1)} = \frac{2\sigma_w^{(n+1)} S}{s t_e}$$

$$\sigma_{f22}^{(n+1)} = \sigma_{f22}^{(n)} + \alpha E_2 \Delta\varepsilon_{f22}^{(n)} \quad , \quad \sigma_{w22}^{(n+1)} = \sigma_{w22}^{(n)} + \alpha E_2 \Delta\varepsilon_{w22}^{(n)}$$

$$\sigma_{f12}^{(n+1)} = \sigma_{f12}^{(n)} + \alpha G_{12} \Delta\varepsilon_{f12}^{(n)} \quad , \quad \sigma_{w12}^{(n+1)} = \sigma_{w12}^{(n)} + \alpha G_{12} \Delta\varepsilon_{w12}^{(n)}$$

where E_2 is the transverse Young’s modulus of the yarns, G_{12} is the longitudinal shear modulus, and α is the lateral contact factor. The lateral contact factor is zero when the trellis mechanism is open and unity if the mechanism is locked with full lateral contact between the yarns. There is a transition range, $\Delta\theta (TA)$, of the average braid angle θ in which the lateral contact factor, α , is a linear function of the average braid angle. The graph of the function $\alpha(\theta)$ is shown in Fig. [2-117](#)

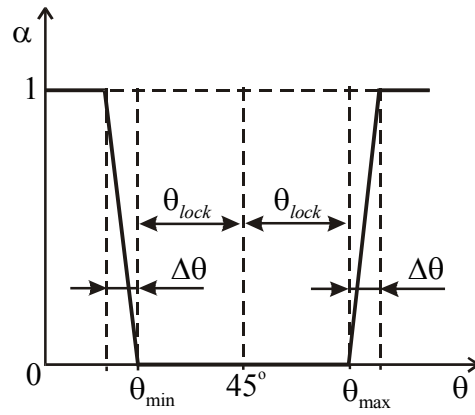

Figure 2-117. The lateral contact factor as a function of average braid angle θ .

***MAT_MICROMECHANICS_DRY_FABRIC**

This is Material Type 235 developed by Tabiei and Ivanov [2001]. The material model derivation utilizes the micro-mechanical approach and the homogenization technique usually used in composite material models. The model accounts for reorientation of the yarns and the fabric architecture. The behavior of the flexible fabric material is achieved by discounting the shear moduli of the material in free state, which allows the simulation of the trellis mechanism before packing the yarns. This material is valid for modeling the elastic response of loose fabric used in inflatable structures, parachutes, body armor, blade containments, and airbags.

Card 1	1	2	3	4	5	6	7	8
Variable	MID	RO	E1	E2	G12	G23	V12	V23
Type	A8	F	F	F	F	F	F	F

Card 2	1	2	3	4	5	6	7	8
Variable	XT	THI	THL	BFI	BWI	DSCF	CNST	ATLR
Type	F	F	F	F	F	F	F	F

Card 3	1	2	3	4	5	6	7	8
Variable	VMB	VME	TRS	FFLG	AOPT			
Type	F	F	F	F	F			

Card 4	1	2	3	4	5	6	7	8
Variable	Not used	Not used	Not used	A1	A2	A3		
Type				F	F	F		

Card 5	1	2	3	4	5	6	7	8
Variable	V1	V2	V3	D1	D2	D3		
Type	F	F	F	F	F	F		

VARIABLE**DESCRIPTION**

MID	Material identification. A unique number or label not exceeding 8 characters must be specified.
RO	Mass density.
E1	E_1 , Young's modulus of the yarn in axial-direction.
E2	E_2 , Young's modulus of the yarn in transverse-direction.
G12	G_{12} , shear modulus of the yarns.
G23	G_{23} , transverse shear modulus of the yarns.
V12	Poisson's ratio.
V23	Transverse Poisson's ratio.
XT	Stress or strain to failure (see FFLG).
THI	Initial brade angle.
THL	Yarn locking angle.
BFI	Initial undulation angle in fill direction.
BWI	Initial undulation angle in warp direction.
DSCF	Discount factor
CNST	Reorientation damping constant
ATLR	Angle tolerance for locking
VME	Viscous modulus for normal strain rate
VMS	Viscous modulus for shear strain rate
TRS	Transverse shear modulus of the fabric layer

VARIABLE	DESCRIPTION
FFLG	Flag for stress-based or strain-based failure EQ.0: XT is a stress to failure NE.0: XT is a strain to failure
AOPT	Material axes option (see MAT_OPTIONTROPIC_ELASTIC for more complete description). AOPT.EQ.0.0: locally orthotropic with material axes determined by element nodes 1, 2 and 4, as with *DEFINE_COORDINATE_NODES. AOPT.EQ.2.0: globally orthotropic with material axes determined by vectors defined below, as with *DEFINED_COORDINATE_VECTOR. AOPT.EQ.3.0: locally orthotropic material axes defined by the cross product of the vector V with the element normal. AOPT.LT.0.0: the absolute value of AOPT is coordinate system ID (CID on *DEFINE_COORDINATE_NODES, *DEFINE_COORDINATE_SYSTEM, or *DEFINED_COORDINATE_VECTOR). Available with the R3 release of 971 and later.
A1 - A3	Components of vector a for AOPT = 2.0
V1 - V3	Components of vector v for AOPT = 3.0
D1 - D3	Components of vector d for AOPT = 2.0

Remarks:

The Representative Volume Cell (RVC) approach is utilized in the micro-mechanical model development. The direction of the yarn in each sub-cell is determined by two angles – the braid angle, θ (*the initial braid angle is 45 degrees*), and the undulation angle of the yarn, which is different for the fill and warp-yarns, β_f and β_w (the initial undulations are normal few degrees), respectively. The starting point for the homogenization of the material properties is the determination of the yarn stiffness matrices.

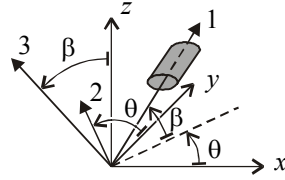

Yarn Orientation

The elasticity tensor is given by

$$[C'] = [S']^{-1} = \begin{bmatrix} \frac{1}{E_1} & -\frac{\nu_{12}}{E_1} & -\frac{\nu_{12}}{E_1} & 0 & 0 & 0 \\ -\frac{\nu_{12}}{E_1} & \frac{1}{E_2} & -\frac{\nu_{23}}{E_2} & 0 & 0 & 0 \\ -\frac{\nu_{12}}{E_1} & -\frac{\nu_{23}}{E_2} & \frac{1}{E_2} & 0 & 0 & 0 \\ 0 & 0 & 0 & \frac{1}{\mu G_{12}} & 0 & 0 \\ 0 & 0 & 0 & 0 & \frac{1}{\mu G_{23}} & 0 \\ 0 & 0 & 0 & 0 & 0 & \frac{1}{\mu G_{12}} \end{bmatrix}^{-1}$$

where E_1 , E_2 , ν_{12} , ν_{23} , G_{12} and G_{23} are Young's moduli, Poisson's ratios, and the shear moduli of the yarn material, respectively. μ is a discount factor, which is function of the braid angle, θ , and has value between μ_0 and 1 as shown in the next figure. Initially, in free stress state, the discount factor is a small value ($DSCF = \mu_0 \ll 1$) and the material has very small resistance to shear deformation if any.

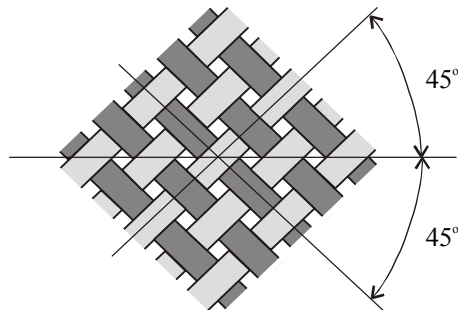

Plain Woven Fabric: Free State

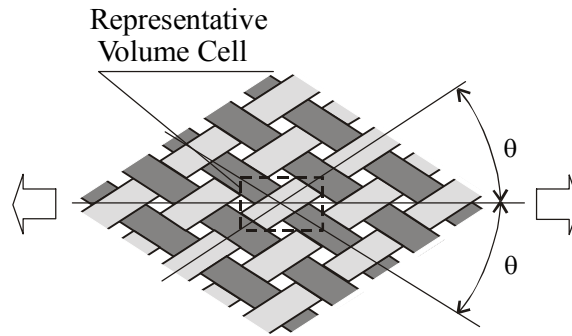

Plain Woven Fabric: Stretched

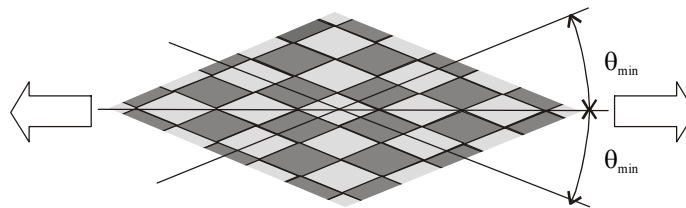

Plain Woven Fabric: Compacted

When the locking occurs, the fabric yarns are packed and they behave like elastic media. The discount factor is unity as shown in the next figure. The micro-mechanical model is developed to account for the reorientation of the yarns up to the locking angle. The locking angle, θ_{lock} , can be obtained from the yarn width and the spacing parameter of the fabric using simple geometrical relationship. The transition range, $\Delta\theta$ (angle tolerance for locking), can be chosen to be as small as possible, but big enough to prevent high frequency oscillations in transition to compacted state and depends on the range to the locking angle and the dynamics of the simulated problem. Reorientation damping constant is defined to damp some of the high frequency oscillations. A simple rate effect is added by defining the viscous modulus for normal or shear strain rate ($VMB*\epsilon_{11or22}$ for normal components and $VMS*\epsilon_{12}$ for the shear components).

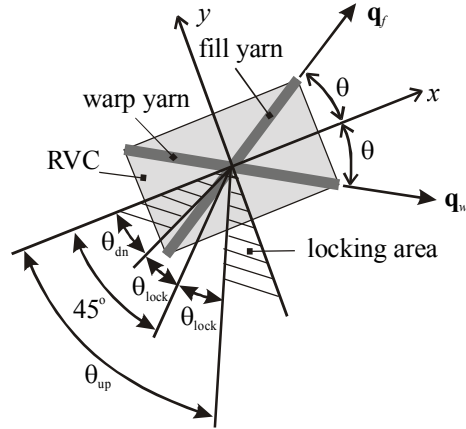

Locking Angles

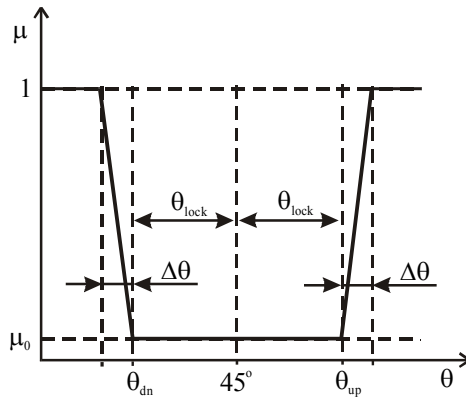

Discount factor as a function of braid angle, θ

***MAT_SCC_ON_RCC**

This is Material Type 236 developed by Carney, Lee, Goldberg, and Santhanam [2007]. This model simulates silicon carbide coating on Reinforced Carbon-Carbon (RCC), a ceramic matrix and is based upon a quasi-orthotropic, linear-elastic, plane-stress model. Additional constitutive model attributes include a simple (i.e. non-damage model based) option that can model the tension crack requirement: a “stress-cutoff” in tension. This option satisfies the tension crack requirements by limiting the stress in tension but not compression, and having the tensile “yielding” (i.e. the stress-cutoff) be fully recoverable – not plasticity or damage based.

Card 1	1	2	3	4	5	6	7	8
Variable	MID	RO	E0	E1	E2	E3	E4	E5
Type	A8	F	F	F	F	F	F	F

Card 2	1	2	3	4	5	6	7	8
Variable	PR	G	G_SCL	TSL	EPS_TAN			
Type	F	F	F	F	F			

VARIABLE**DESCRIPTION**

MID	Material identification. A unique number or label not exceeding 8 characters must be specified.
RO	Mass density.
E0	E ₀ , See Remarks below.
E1	E ₁ , See Remarks below.
E2	E ₂ , See Remarks below.
E3	E ₃ , See Remarks below.
E4	E ₄ , See Remarks below.
E5	E ₅ , Young’s modulus of the yarn in transverse-direction.
PR	Poisson’s ratio.

VARIABLE	DESCRIPTION
G	Shear modulus
G_SCL	Shear modulus multiplier (default = 1.0).
TSL	Tensile limit stress
EPS_TAN	Strain at which E = tangent to the polynomial curve.

Remarks:

This model for the silicon carbide coating on RCC is based upon a quasi-orthotropic, linear-elastic, plane-stress model, given by:

$$\begin{Bmatrix} \sigma_1 \\ \sigma_2 \\ \tau_{12} \end{Bmatrix} = \begin{bmatrix} \frac{E}{1-\nu^2} & \frac{\nu E}{1-\nu^2} & 0 \\ \frac{\nu E}{1-\nu^2} & \frac{E}{1-\nu^2} & 0 \\ 0 & 0 & G_{12} \end{bmatrix} \begin{Bmatrix} \varepsilon_1 \\ \varepsilon_2 \\ \gamma_{12} \end{Bmatrix}$$

Additional constitutive model requirements include a simple (i.e. non-damage model based) option that can model the tension crack requirement: a “stress-cutoff” in tension. This option satisfies the tension crack requirements by limiting the stress in tension but not compression, and having the tensile “yielding” (i.e. the stress-cutoff) be fully recoverable – not plasticity or damage based.

The tension stress-cutoff separately resets the stress to a limit value when it is exceeded in each of the two principal directions. There is also a strain-based memory criterion that ensures unloading follows the same path as loading: the “memory criterion” is the tension stress assuming that no stress cutoffs were in effect. In this way, when the memory criterion exceeds the user-specified cutoff stress, the actual stress will be set to that value. When the element unloads and the memory criterion falls back below the stress cutoff, normal behavior resumes. Using this criterion is a simple way to ensure that unloading does not result in any hysteresis. The cutoff criterion cannot be based on an effective stress value because effective stress does not discriminate between tension and compression, and also includes shear. This means that the in plane, 1- and 2- directions must be modeled as independent to use the stress cutoff. Because the Poisson’s ratio is not zero, this assumption is not true for cracks that may arbitrarily lie along any direction. However, careful examination of damaged RCC shows that generally, the surface cracks do tend to lie in the fabric directions, meaning that cracks tend to open in the 1- or the 2- direction independently. So the assumption of directional independence for tension cracks may be appropriate for the coating because of this observed orthotropy.

The quasi-orthotropic, linear-elastic, plane-stress model with tension stress cutoff (to simulate tension cracks) can model the as-fabricated coating properties, which do not show

nonlinearities, but not the non-linear response of the flight-degraded material. Explicit finite element analysis (FEA) lends itself to *nonlinear-elastic* stress-strain relation instead of linear-elastic. Thus, instead of $\sigma = \mathbf{E}\varepsilon$, the modulus will be defined as a function of some effective strain quantity, or $\sigma = \mathbf{E}(\varepsilon_{\text{eff}}) \cdot \varepsilon$, even though it is uncertain, from the available data, whether or not the coating response is completely nonlinear-elastic, and does not include some damage mechanism.

This nonlinear-elastic model cannot be implemented into a closed form solution or into an implicit solver; however, for explicit FEA such as is used for LS-DYNA impact analysis, the modulus can be adjusted at each time step to a higher or lower value as desired. In order to model the desired S-shape response curve of flight-degraded RCC coating, a function of strain that replicates the desired response must be found. It is assumed that the nonlinearities in the material are recoverable (elastic) and that the modulus is communicative between the 1- and 2- directions (going against the tension-crack assumption that the two directions do not interact). Sometimes stability can be a problem for this type of nonlinearity modeling, however, stability was not found to be a problem with the material constants used for the coating.

The von Mises strain is selected for the effective strain definition as it couples the 3-dimensional loading but reduces to uniaxial data, so that the desired uniaxial compressive response can be reproduced. So,

$$\varepsilon_{\text{eff}} = \frac{1}{\sqrt{2}} \frac{1}{1 + \nu} \sqrt{(\varepsilon_1 - \varepsilon_2)^2 + (\varepsilon_2 - \varepsilon_3)^2 + (\varepsilon_1 - \varepsilon_3)^2 + 3\gamma_{12}^2}$$

where for a 2-D, isotropic shell element case, the z-direction strain is given by:

$$\varepsilon_3 = \frac{-\nu}{1 - \nu} (\varepsilon_1 + \varepsilon_2)$$

The function for modulus is implemented as an arbitrary 5th order polynomial:

$$E(\varepsilon_{\text{eff}}) = A_0\varepsilon_{\text{eff}}^0 + A_1\varepsilon_{\text{eff}}^1 + \dots + A_5\varepsilon_{\text{eff}}^5$$

In the case of as-fabricated material the first coefficient (A_0) is simply the modulus E, and the other coefficients ($A_{n>0}$) are zero, reducing to a 0th order polynomial, or linear. To match the degraded stress-strain compression curve, a higher order polynomial is needed. Six conditions on stress were used (stress and its derivative at beginning, middle, and end of the curve) to obtain a 5th order polynomial, and then the derivative of that equation was taken to obtain modulus as a function of strain, yielding a 4th order polynomial that represents the degraded coating modulus vs. strain curve.

For values of strain which exceed the failure strain observed in the laminate compression tests, the higher order polynomial will no longer match the test data. Therefore, after a specified effective-strain, representing failure, the modulus is defined to be the tangent of the polynomial curve. As a result, the stress/strain response has a continuous derivative, which aids in avoiding numerical instabilities. The test data does not clearly define the

failure strain of the coating, but in the impact test it appears that the coating has a higher compressive failure strain in bending than the laminate failure strain.

The two dominant modes of loading which cause coating loss on the impact side of the RCC (the front-side) are in-plane compression and transverse shear. The in-plane compression is measured by the peak out of plane tensile strain, ϵ_3 . As there is no direct loading of a shell element in this direction, ϵ_3 is computed through Poisson's relation $\epsilon_3 = \frac{-\nu}{1-\nu}(\epsilon_1 + \epsilon_2)$. When ϵ_3 is tensile, it implies that the average of ϵ_1 and ϵ_2 is compressive. This failure mode will likely dominate when the RCC undergoes large bending, putting the front-side coating in high compressive strains. It is expected that a transverse shear failure mode will dominate when the debris source is very hard or very fast. By definition, the shell element cannot give a precise account of the transverse shear throughout the RCC's thickness. However, the Belytschko-Tsay shell element formulation in LS-DYNA has a first-order approximation of transverse shear that is based on the out-of-plane nodal displacements and rotations that should suffice to give a qualitative evaluation of the transverse shear. By this formulation, the transverse shear is constant through the entire shell thickness and thus violates surface-traction conditions. The constitutive model implementation records the peak value of the tensile out-of-plane strain (ϵ_3) and peak root-mean-sum transverse-shear: $\sqrt{\epsilon_{13}^2 + \epsilon_{23}^2}$.

***MAT_PML_HYSTERETIC**

This is Material Type 237. This is a perfectly-matched layer (PML) material with a Biot linear hysteretic constitutive law, to be used in a wave-absorbing layer adjacent to a Biot hysteretic material (*MAT_BIOT_HYSTERETIC) in order to simulate wave propagation in an unbounded medium with material damping. This material is the visco-elastic counterpart of the elastic PML material (*MAT_PML_ELASTIC). See the Remarks sections of *MAT_PML_ELASTIC (*MAT_230) and *MAT_BIOT_HYSTERETIC (*MAT_232) for further details.

Card	1	2	3	4	5	6	7	8
Variable	MID	RO	E	PR	ZT	FD		
Type	A8	F	F	F	F	F		
Default	none	none	none	none	0.0	3.25		

VARIABLE**DESCRIPTION**

MID	Material identification. A unique number or label not exceeding 8 characters must be specified.
RO	Mass density.
E	Young's modulus.
PR	Poisson's ratio.
ZT	Damping ratio
FD	Dominant excitation frequency in Hz

***MAT_PERT_PIECEWISE_LINEAR_PLASTICITY**

This is Material Type 238. It is a duplicate of Material Type 24 (*MAT_PIECEWISE_LINEAR_PLASTICITY) modified for use with *PERTURBATION_MATERIAL and solid elements in an explicit analysis. It should give exactly the same values as the original material, if used exactly the same. It exists as a separate material type because of the speed penalty (an approximately 10% increase in the overall execution time) associated with the use of a material perturbation.

See Material Type 24 (*MAT_PIECEWISE_LINEAR_PLASTICITY) for a description of the material parameters. All of the documentation for Material Type 24 applies. Recommend practice is to first create the input deck using Material Type 24. Additionally, the CMP variable in the *PERTURBATION_MATERIAL must be set to affect a specific variables in the MAT_238 definition as defined in the following table; for example, CMP = 5 will perturb the yield stress.

CMP value	Material variable
3	E
5	SIGY
6	ETAN
7	FAIL

*MAT_240

*MAT_COHESIVE_MIXED_MODE_ELASTOPLASTIC_RATE

*MAT_COHESIVE_MIXED_MODE_ELASTOPLASTIC_RATE

This is Material Type 240. This model is a rate-dependent, elastic-ideally plastic cohesive zone model. It includes a tri-linear traction-separation law with a quadratic yield and damage initiation criterion in mixed-mode loading, while the damage evolution is governed by a power-law formulation. It can be used with solid element types 19 and 20, and is not available for other solid element formulations. See the remarks after *SECTION_SOLID for a description of element types 19 and 20.

Card 1	1	2	3	4	5	6	7	8
Variable	MID	RO	ROFLG	INTFAIL	EMOD	GMOD	THICK	OUTPUT
Type	A8	F	F	F	F	F	F	F

Card 2	1	2	3	4	5	6	7	8
Variable	G1C_0	G1C_INF	EDOT_G1	T0	T1	EDOT_T	FG1	
Type	F	F	F	F	F	F	F	

Card 3	1	2	3	4	5	6	7	8
Variable	G2C_0	G2C_INF	EDOT_G2	S0	S1	EDOT_S	FG2	
Type	F	F	F	F	F	F	F	

VARIABLE

DESCRIPTION

MID	Material identification. A unique number or label not exceeding 8 characters must be specified.
RO	Mass density
ROFLG	Flag for whether density is specified per unit area or volume. ROFLG = 0 specified density per unit volume (default), and ROFLG = 1 specifies the density is per unit area for controlling the mass of cohesive elements with an initial volume of zero.

VARIABLE	DESCRIPTION
INTFAIL	The number of integration points required for the cohesive element to be deleted. If it is zero, the element won't be deleted even if it satisfies the failure criterion. The value of INTFAIL may range from 1 to 4, with 1 the recommended value.
EMOD	The Young's modulus of the material
GMOD	The shear modulus of the material
THICK	GT.0.0: Cohesive thickness LE.0.0: Initial thickness is calculated from nodal coordinates
OUTPUT	Time interval at which output is written into FORT.11-File
G1C_0	GT.0.0: Energy release rate G _{IC} in Mode I LE.0.0: Lower bound value of rate-dependent G _{IC}
G1C_INF	Upper bound value of rate-dependent G _{IC} (only considered if G1C_0 < 0)
EDOT_G1	Equivalent strain rate at yield initiation to describe the rate dependency of G _{IC} (only considered if G1C_0 < 0)
T0	GT.0.0: Yield stress in Mode I LT.0.0: Rate-dependency is considered, Parameter T0
T1	Parameter T1, only considered if T0 < 0: GT.0.0: Quadratic logarithmic model LT.0.0: Linear logarithmic model
EDOT_T	Equivalent strain rate at yield initiation to describe the rate dependency of the yield stress in Mode I (only considered if T0 < 0)
FG1	Parameter f _{G1} to describe the tri-linear shape of the traction-separation law in Mode I
G2C_0	GT.0.0: Energy release rate G _{IIC} in Mode II LE.0.0: Lower bound value of rate-dependent G _{IIC}
G2C_INF	Upper bound value of G _{IIC} (only considered if G2C_0 < 0)

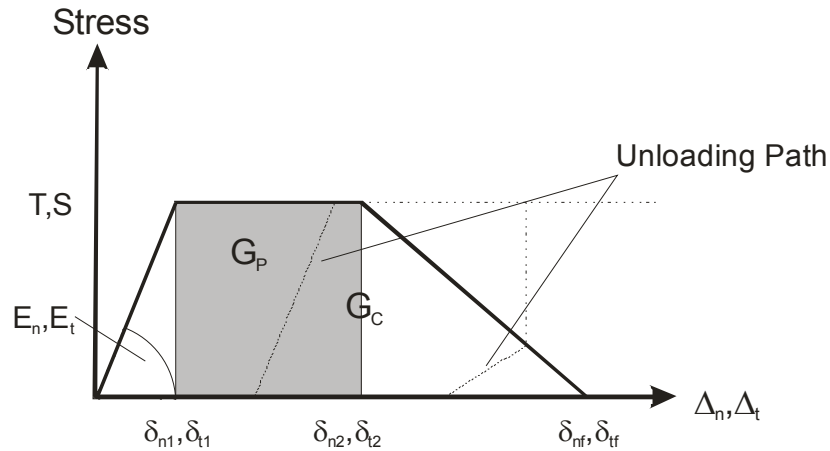

Figure 2-118. Trilinear traction separation law

VARIABLE	DESCRIPTION
EDOT_G2	Equivalent strain rate at yield initiation to describe the rate dependency of G_{IIC} (only considered if $G2C_0 < 0$)
S0	GT.0.0: Yield stress in Mode II LT.0.0: Rate-dependency is considered, Parameter S0
S1	Parameter S1, only considered if $S0 < 0$: GT.0.0: Quadratic logarithmic model is applied LT.0.0: Linear logarithmic model is applied
EDOT_S	Equivalent strain rate at yield initiation to describe the rate dependency of the yield stress in Mode II (only considered if $S0 < 0$)
FG2	Parameter f_{c2} to describe the tri-linear shape of the traction-separation law in Mode II

Remarks:

The model is a tri-linear elastic-ideally plastic Cohesive Zone Model, which was developed by Marzi et al. [2009]. It looks similar to *MAT_185, but considers effects of plasticity and rate-dependency. Since the entire separation at failure is plastic, no brittle fracture behavior can be modeled with this material type.

The separations Δ_n in normal (peel) and Δ_t in tangential (shear) direction are calculated from the element's separations in the integration points,

$$\Delta_n = \max(u_n, 0)$$

and

$$\Delta_t = \sqrt{u_{t1}^2 + u_{t2}^2},$$

u_n , u_{t1} and u_{t2} are the separations in normal and in the both tangential directions of the element coordinate system. The total (mixed-mode) separation Δ_m is determined by

$$\Delta_m = \sqrt{\Delta_n^2 + \Delta_t^2}.$$

The initial stiffnesses in both modes are calculated from the elastic Young's and shear moduli and are respectively,

$$E_n = \frac{\text{EMOD}}{\text{THICK}}$$

$$E_t = \frac{\text{GMOD}}{\text{THICK}'},$$

Where THICK, the element's thickness, is an input parameter. Unless the input THICK > 0 it is calculated from the distance between the initial positions of the element's corner nodes (Nodes 1-5, 2-6, 3-7 and 4-8, respectively).

While the total energy under the traction-separation law is given by G_C , one further parameter is needed to describe the exact shape of the tri-linear material model. If the area (energy) under the constant stress (plateau) region is denoted G_P (see 2-118), a parameter f_G defines the shape of the traction-separation law,

for mode I loading:

$$0 \leq f_{G1} = \frac{G_{I,P}}{G_{IC}} < 1 - \frac{T^2}{2G_{IC}E_n} < 1$$

for mode II loading:

$$0 \leq f_{G2} = \frac{G_{II,P}}{G_{IIC}} < 1 - \frac{S^2}{2G_{IIC}E_t} < 1$$

While f_{G1} and f_{G2} are always constant values, T , S , G_{IC} and G_{IIC} may be chosen as functions of an equivalent strain rate $\dot{\epsilon}_{eq}$, which is evaluated by

$$\dot{\epsilon}_{eq} = \frac{\sqrt{\dot{u}_n^2 + \dot{u}_{t1}^2 + \dot{u}_{t2}^2}}{\text{THICK}},$$

where \dot{u}_n , \dot{u}_{t1} and \dot{u}_{t2} are the velocities corresponding to the separations u_n , u_{t1} and u_{t2} .

For the yield stresses, two rate dependent formulations are implemented:

1. A quadratic logarithmic function:

for mode I if $T0 < 0$ and $T1 > 0$:

$$T(\dot{\epsilon}_{eq}) = |T0| + |T1| \left[\max \left(0, \ln \frac{\dot{\epsilon}_{eq}}{EDOT_T} \right) \right]^2$$

for mode II if $S0 < 0$ and $S1 > 0$:

$$S(\dot{\epsilon}_{eq}) = |S0| + |S1| \left[\max \left(0, \ln \frac{\dot{\epsilon}_{eq}}{EDOT_S} \right) \right]^2$$

2. A linear logarithmic function:

for mode I if $T0 < 0$ and $T1 < 0$:

$$T(\dot{\epsilon}_{eq}) = |T0| + |T1| \max \left(0, \ln \frac{\dot{\epsilon}_{eq}}{EDOT_T} \right)$$

for mode II if $S0 < 0$ and $S1 < 0$:

$$S(\dot{\epsilon}_{eq}) = |S0| + |S1| \max \left(0, \ln \frac{\dot{\epsilon}_{eq}}{EDOT_S} \right)$$

Alternatively, T and S can be set to constant values:

for mode I if $T0 > 0$:

$$T(\dot{\epsilon}_{eq}) = T0$$

for mode II if $S0 > 0$:

$$S(\dot{\epsilon}_{eq}) = S0$$

The rate-dependency of the fracture energies are given by

if $G1C_0 < 0$:

$$G_{IC}(\dot{\epsilon}_{eq}) = |G1C_0| + (G1C_INF - |G1C_0|) \exp \left(- \frac{EDOT_G1}{\dot{\epsilon}_{eq}} \right)$$

if $G2C_0 < 0$:

$$G_{IIC}(\dot{\epsilon}_{eq}) = |G2C_0| + (G2C_INF - |G2C_0|) \exp \left(- \frac{EDOT_G2}{\dot{\epsilon}_{eq}} \right)$$

If positive values are chosen for $G1C_0$ or $G2C_0$, no rate-dependency is considered for this parameter and its value remains constant as specified by the user.

It should be noticed, that the equivalent strain rate $\dot{\epsilon}_{eq}$ is updated until $\Delta_m > \delta_{m1}$, then the model behavior depends on the equivalent strain rate at yield initiation.

Having defined the parameters describing the single modes, the mixed-mode behavior is formulated by quadratic initiation criteria for both yield stress and damage initiation, while the damage evolution follows a Power-Law.

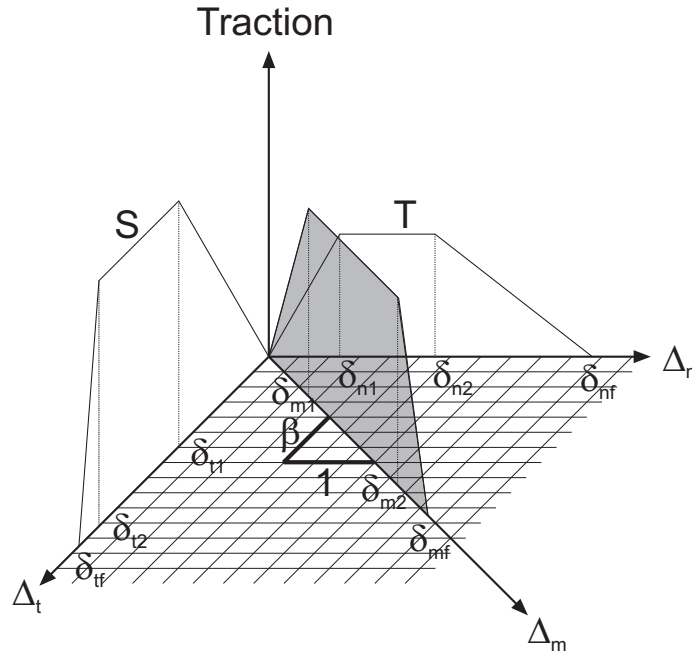

Figure 2-119. Trilinear mixed mode traction-separation law

Due to reasons of readability, the following simplifications are made,

$$T = T(\dot{\epsilon}_{eq}), S = S(\dot{\epsilon}_{eq}), G_{IC} = G_{IC}(\dot{\epsilon}_{eq}) \text{ and } G_{IIC} = G_{IIC}(\dot{\epsilon}_{eq}).$$

The mixed-mode yield initiation displacement δ_{m1} is defined as

$$\delta_{m1} = \delta_{n1} \delta_{t1} \sqrt{\frac{1 + \beta^2}{\delta_{t1}^2 + (\beta \delta_{n1})^2}},$$

where $\delta_{n1} = \frac{T}{E_n}$ and $\delta_{t1} = \frac{S}{E_t}$ are the single-mode yield initiation displacements and $\beta = \frac{\delta_{t1}}{\delta_{n1}}$ is the mixed-mode ratio. Analog to the yield initiation, the damage initiation displacement δ_{m2} is defined:

$$\delta_{m2} = \delta_{n2} \delta_{t2} \sqrt{\frac{1 + \beta^2}{\delta_{t2}^2 + (\beta \delta_{n2})^2}},$$

where

$$\delta_{n2} = \delta_{n1} + \frac{f_{G1} G_{IC}}{T}$$

$$\delta_{t2} = \delta_{t1} + \frac{f_{G2} G_{IIC}}{S}.$$

With $\gamma = \arccos\left(\frac{\langle u_n \rangle}{\Delta_m}\right)$, the ultimate (failure) displacement δ_{mf} can be written,

$$\delta_{mf} = \frac{\delta_{m1}(\delta_{m1} - \delta_{m2})E_n G_{IIC} \cos^2 \gamma + G_{IC}(2G_{IIC} + \delta_{m1}(\delta_{m1} - \delta_{m2})E_t \sin^2 \gamma)}{\delta_{m1}(E_n G_{IIC} \cos^2 \gamma + E_t G_{IC} \sin^2 \gamma)}.$$

This formulation describes a power-law damage evolution with an exponent $\eta = 1.0$ (see *MAT_138).

After the shape of the mixed-mode traction-separation law has been determined by δ_{m1} , δ_{m2} and δ_{mf} , the plastic separation in each element direction, $u_{n,P}$, $u_{t1,P}$ and $u_{t2,P}$ can be calculated. The plastic separation in peel direction is given by

$$u_{n,P} = \max(u_{n,P,\Delta t-1}, u_n - \delta_{m1} \sin \gamma, 0).$$

In shear direction, a shear yield separation $\delta_{t,y}$,

$$\delta_{t,y} = \sqrt{(u_{t1} - u_{t1,P,\Delta t-1})^2 + (u_{t2} - u_{t2,P,\Delta t-1})^2},$$

is defined. If $\delta_{t,y} > \delta_{m1} \sin \gamma$, the plastic shear separations in the element coordinate system are updated,

$$u_{t1,P} = u_{t1,P,\Delta t-1} + u_{t1} - u_{t1,\Delta t-1}$$

$$u_{t2,P} = u_{t2,P,\Delta t-1} + u_{t2} - u_{t2,\Delta t-1}.$$

In the formulas above, $\Delta t - 1$ indicates the individual value from the last time increment. In case $\Delta_m > \delta_{m2}$, the damage initiation criterion is satisfied and a damage variable D increases monotonically,

$$D = \max\left(\frac{\Delta_m - \delta_{m2}}{\delta_{mf} - \delta_{m2}}, D_{\Delta t-1}, 0\right).$$

When $\Delta_m > \delta_{mf}$, complete damage ($D = 1$) is reached and the element fails in the corresponding integration point.

Finally, the peel and the shear stresses in element directions are calculated,

$$\sigma_{t1} = E_t(1 - D)(u_{t1} - u_{t1,P})$$

$$\sigma_{t2} = E_t(1 - D)(u_{t2} - u_{t2,P}).$$

In peel direction, no damage under pressure loads is considered if $u_n - u_{n,P} > 0$

$$\sigma_n = E_n(u_n - u_{n,P})$$

otherwise,

$$\sigma_n = E_n(1 - D)(u_n - u_{n,P})$$

Reference:

S. Marzi, O. Hesebeck, M. Brede and F. Kleiner (2009), A Rate-Dependent, Elasto-Plastic Cohesive Zone Mixed-Mode Model for Crash Analysis of Adhesively Bonded Joints, In Proceeding: *7th European LS-DYNA Conference, Salzburg*

***MAT_JOHNSON_HOLMQUIST_JH1**

This is Material Type 241. This Johnson-Holmquist Plasticity Damage Model is useful for modeling ceramics, glass and other brittle materials. This version corresponds to the original version of the model, JH1, and Material Type 110 corresponds to JH2, the updated model.

Card 1	1	2	3	4	5	6	7	8
Variable	MID	RO	G	P1	S1	P2	S2	C
Type	A8	F	F	F	F	F	F	F

Card 2	1	2	3	4	5	6	7	8
Variable	EPSI	T		ALPHA	SFMAX	BETA	DP1	
Type	F	F	F	F	F	F	F	

Card 3	1	2	3	4	5	6	7	8
Variable	EPFMIN	EPFMAX	K1	K2	K3	FS		
Type	F	F	F	F	F	F		

VARIABLE**DESCRIPTION**

MID	Material identification. A unique number or label not exceeding 8 characters must be specified.
RO	Density.
G	Shear modulus.
P1	Pressure point 1 for intact material.
S1	Effective stress at P1.
P2	Pressure point 2 for intact material.
S2	Effective stress at P2.

VARIABLE	DESCRIPTION
C	Strain rate sensitivity factor.
EPSI	Quasi-static threshold strain rate. See *MAT_015.
T	Maximum tensile pressure strength. This value is positive in tension.
ALPHA	Initial slope of the fractured material strength curve. See Figure 2-120 .
SFMAX	Maximum strength of the fractured material.
BETA	Fraction of elastic energy loss converted to hydrostatic energy (affects bulking pressure (history variable 1) that accompanies damage).
DP1	Maximum compressive pressure strength. This value is positive in compression.
EPFMIN	Plastic strain for fracture at tensile pressure T. See Figure 2-121 .
EPFMAX	Plastic strain for fracture at compressive pressure DP1. See Figure 2-120 .
K1	First pressure coefficient (equivalent to the bulk modulus).
K2	Second pressure coefficient.
K3	Third pressure coefficient.
FS	Element deletion criteria. LT.0: delete if $P < FS$ (tensile failure). EQ.0: no element deletion (default). GT.0: delete element if the $\bar{\epsilon}^p > FS$.

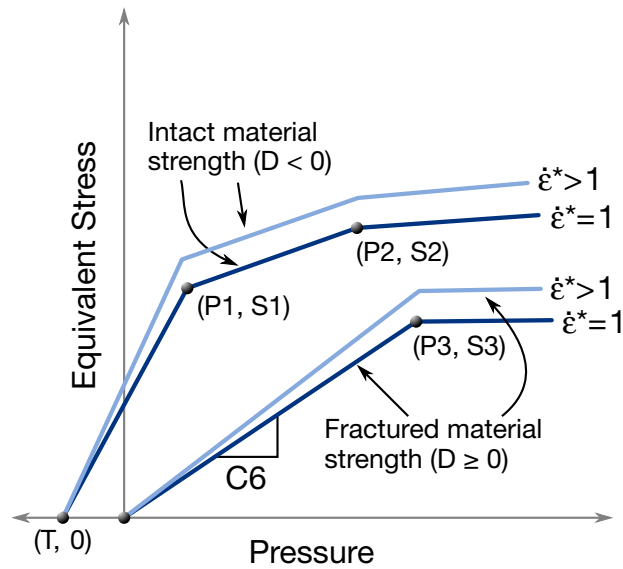

Figure 2-120. Strength: equivalent stress versus pressure.

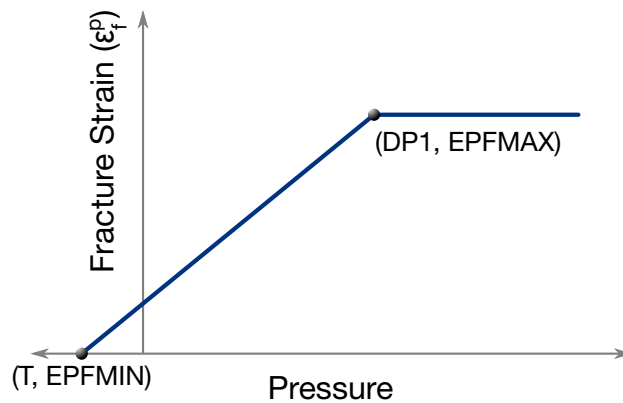

Figure 2-121. Fracture strain versus pressure.

Remarks:

The equivalent stress for both intact and fractured ceramic-type materials is given by

$$\sigma_y = (1 + c \ln \epsilon^*) \sigma(P)$$

where $\sigma(P)$ is evaluated according to [Figure 2-120](#).

$$D = \sum \Delta \epsilon^p / \epsilon_f^p(P)$$

represents the accumulated damage (history variable 2) based upon the increase in plastic strain per computational cycle and the plastic strain to fracture is evaluated according to [Figure 2-121](#).

In undamaged material, the hydrostatic pressure is given by

$$P = k_1\mu + k_2\mu^2 + k_3\mu^3 + \Delta P$$

in compression and by

$$P = k_1\mu + \Delta P$$

in tension where $\mu = \rho/\rho_0 - 1$. A fraction, between 0 and 1, of the elastic energy loss, β , is converted into hydrostatic potential energy (pressure). The pressure increment, ΔP , associated with the increment in the hydrostatic potential energy is calculated at fracture, where σ_y and σ_y^f are the intact and failed yield stresses respectively. This pressure increment is applied both in compression and tension, which is not true for JH2 where the increment is added only in compression.

$$\Delta P = -k_1\mu_f + \sqrt{(k_1\mu_f)^2 + 2\beta k_1\Delta U}$$

$$\Delta U = \frac{\sigma_y - \sigma_y^f}{6G}$$

*MAT_242

*MAT_KINEMATIC_HARDENING_BARLAT2000

*MAT_KINEMATIC_HARDENING_BARLAT2000

This is Material Type 242. This model combines Yoshida non-linear kinematic hardening rule (*MAT_125) with the 8-parameter material model of Barlat and Lian (2003) (*MAT_133) to model metal sheets under cyclic plasticity loading and with anisotropy in plane stress condition. Also see manual pages in *MAT_226.

Card 1	1	2	3	4	5	6	7	8
Variable	MID	R0	E	PR			M	
Type	I	F	F	F			F	
Default	none	0.0	0.0	0.0			none	

Card 2	1	2	3	4	5	6	7	8
Variable	ALPHA1	ALPHA2	ALPHA3	ALPHA4	ALPHA5	ALPHA6	ALPHA7	ALPHA8
Type	F	F	F	F	F	F	F	I
Default	0.0	0.0	0.0	0.0	0.0	0.0	0.0	none

Card 3	1	2	3	4	5	6	7	8
Variable								
Type								
Default								

Card 4	1	2	3	4	5	6	7	8
Variable								
Type								
Default								

Card 5	1	2	3	4	5	6	7	8
Variable	CB	Y	C	K	RSAT	SB	H	
Type	F	F	F	F	F	F	F	
Default	none	none	none	none	none	none	none	

Card 6	1	2	3	4	5	6	7	8
Variable	AOPT		IOPT	C1	C2			
Type	I		I	F	F			
Default	none		none	0.0	0.0			

Card 7	1	2	3	4	5	6	7	8
Variable	XP	YP	ZP	A1	A2	A3		
Type	F	F	F	F	F	F		
Default	none	none	none	none	none	none		

Card 8	1	2	3	4	5	6	7	8
Variable	V1	V2	V3	D1	D2	D3		
Type	F	F	F	F	F	F		
Default	none	none	none	none	none	none		

VARIABLE**DESCRIPTION**

MID	Material identification. A unique number must be specified.
RO	Mass density,
E	Young's modulus, E,
PR	Poisson's ratio, ν ,
M	Flow potential exponent,
ALPHA1	α_1 , material constant in Barlat's yield equation,
ALPHA2	α_2 , material constant in Barlat's yield equation,
ALPHA3	α_3 , material constant in Barlat's yield equation,
ALPHA4	α_4 , material constant in Barlat's yield equation,
ALPHA5	α_5 , material constant in Barlat's yield equation,
ALPHA6	α_6 , material constant in Barlat's yield equation,
ALPHA7	α_7 , material constant in Barlat's yield equation,
ALPHA8	α_8 , material constant in Barlat's yield equation,
CB	The uppercase B defined in the Yoshida's equations,
Y	Anisotropic parameter associated with work-hardening stagnation, defined in the Yoshida's equations,
SC	The lowercase c defined in the Yoshida's equations,
K	Hardening parameter as defined in the Yoshida's equations,
RSAT	Hardening parameter as defined in the Yoshida's equations,
SB	The lowercase b as defined in the Yoshida's equations,

VARIABLE	DESCRIPTION
H	Anisotropic parameter associated with work-hardening stagnation, defined in the following Yoshida's equations,
AOPT	Material axes option (see MAT_OPTIONTROPIC_ELASTIC for a more complete description): EQ.0.0: locally orthotropic with material axes determined by element nodes 1, 2, and 4, as with *DEFINE_COORDINATE_NODES. EQ.2.0: globally orthotropic with material axes determined by vectors defined below, as with *DEFINE_COORDINATE_VECTOR. EQ.3.0: locally orthotropic material axes determined by rotating the material axes about the element normal by an angle, BETA, from a line in the plane of the element defined by the cross product of the vector \mathbf{v} with the element normal. LT.0.0: the absolute value of AOPT is a coordinate system ID number (CID on *DEFINE_COORDINATE_NODES, *DEFINE_COORDINATE_SYSTEM or *DEFINE_COORDINATE_VECTOR). Available with the R3 release of Version 971 and later.
IOPT	Kinematic hardening rule flag: EQ.0: Original Yoshida formulation, EQ.1: Modified formulation. Define C1, C2 below,
C1, C2	Constants used to modify R: $R = \text{RSAT} \times [(C_1 + \bar{\epsilon}^p)^{c_2} - C_1^{c_2}]$
XP, YP, ZP	Coordinates of point \mathbf{p} for AOPT = 1,
A1, A2, A3	Components of vector \mathbf{a} for AOPT = 2,
V1, V2, V3	Components of vector \mathbf{v} for AOPT = 3,
D1, D2, D3	Components of vector \mathbf{d} for AOPT = 2.

Remarks:

1. A total of eight parameters (α_1 to α_8) are needed to describe the yield surface. The parameters can be determined with tensile tests in three directions and an equal

biaxial tension test. For detailed theoretical background and material parameters of some typical FCC materials, please see remarks in *MAT_133 and Barlat's 2003 paper.

2. NUMISHEET 2005 provided a complete set of the parameters of AL5182-O for Benchmark #2, the cross member, as below (flow potential exponent $M = 8$):

α_1	α_2	α_3	α_4	α_5	α_6	α_7	α_8
0.94	1.08	0.97	1.0	1.0	1.02	1.03	1.11

3. For a more detailed description on the Yoshida model and parameters, please see Remarks in *MAT_226 and *MAT_125.
4. For information on variable AOPT please see remarks in *MAT_226.
5. To improve convergence, it is recommended that *CONTROL_IMPLICIT_FORMING type '1' be used when conducting springback simulation.
6. This material model is available in LS-DYNA R5 Revision 58432 or later releases.

***MAT_HILL_90**

This is Material Type 243. This model was developed by Hill [1990] for modeling sheets with anisotropic materials under plane stress conditions. This material allows the use of the Lankford parameters for the definition of the anisotropy. All features of this model are the same as in *MAT_036, only the yield condition and associated flow rules are replaced by the Hill90 equations.

Card 1	1	2	3	4	5	6	7	8
Variable	MID	R0	E	PR	HR	P1	P2	ITER
Type	A8	F	F	F	F	F	F	F

Card 2	1	2	3	4	5	6	7	8
Variable	M	R00 / AH	R45 / BH	R90 / CH	LCID	E0	SPI	P3
Type	F	F	F	F	I	F	F	F

Hardening Card. Additional Card for $M < 0$.

Card 3	1	2	3	4	5	6	7	8
Variable	CRC1	CRA1	CRC2	CRA2	CRC3	CRA3	CRC4	CRA4
Type	F	F	F	F	F	F	F	F

Card 4	1	2	3	4	5	6	7	8
Variable	AOPT	C	P	VLCID		FLAG		
Type	F	F	F	I		F		

Card 5	1	2	3	4	5	6	7	8
Variable				A1	A2	A3		
Type				F	F	F		

Card 6	1	2	3	4	5	6	7	8
Variable	V1	V2	V3	D1	D2	D3	BETA	
Type	F	F	F	F	F	F	F	

This card is optional.

Card 6	1	2	3	4	5	6	7	8
Variable	USRFAIL							
Type	F							

VARIABLE	DESCRIPTION
MID	Material identification. A unique number or label not exceeding 8 characters must be specified.
RO	Mass density.
E	Young's modulus, E GT.0.0: Constant value, LT.0.0: Load curve ID = (-E) which defines Young's Modulus as a function of plastic strain. See Remark 1.
PR	Poisson's ratio, ν

VARIABLE	DESCRIPTION
HR	Hardening rule: EQ.1.0: linear (default), EQ.2.0: exponential (Swift) EQ.3.0: load curve or table with strain rate effects EQ.4.0: exponential (Voce) EQ.5.0: exponential (Gosh) EQ.6.0: exponential (Hockett-Sherby) EQ.7.0: load curves in three directions EQ.8.0: table with temperature dependence EQ.9.0: 3d table with temperature and strain rate dependence
P1	Material parameter: HR.EQ.1.0: Tangent modulus, HR.EQ.2.0: k, strength coefficient for Swift exponential hardening HR.EQ.4.0: a, coefficient for Voce exponential hardening HR.EQ.5.0: k, strength coefficient for Gosh exponential hardening HR.EQ.6.0: a, coefficient for Hockett-Sherby exponential hardening HR.EQ.7.0: load curve ID for hardening in 45 degree direction. See Remark 2.
P2	Material parameter: HR.EQ.1.0: Yield stress HR.EQ.2.0: n, exponent for Swift exponential hardening HR.EQ.4.0: c, coefficient for Voce exponential hardening HR.EQ.5.0: n, exponent for Gosh exponential hardening HR.EQ.6.0: c, coefficient for Hockett-Sherby exponential hardening HR.EQ.7.0: load curve ID for hardening in 90 degree direction. See Remark 2.

VARIABLE	DESCRIPTION
ITER	Iteration flag for speed: ITER.EQ.0.0: fully iterative ITER.EQ.1.0: fixed at three iterations Generally, ITER = 0 is recommended. However, ITER = 1 is somewhat faster and may give acceptable results in most problems.
M	m, exponent in Hill's yield surface, absolute value is used if negative. Typically, m ranges between 1 and 2 for low-r materials, such as aluminum (AA6111: $m \approx 1.5$), and is greater than 2 for high r-values, as in steel (DP600: $m \approx 4$).
CRCN	Chaboche-Roussiler hardening parameter, see remarks.
CRCA	Chaboche-Roussiler hardening parameter, see remarks.
R00	R ₀₀ , Lankford parameter in 0 degree direction GT.0.0: Constant value, LT.0.0: Load curve or Table ID = (-R00) which defines R value as a function of plastic strain (Curve) or as a function of temperature and plastic strain (Table). See Remark 3.
R45	R ₄₅ , Lankford parameter in 45 degree direction GT.0.0: Constant value, LT.0.0: Load curve or Table ID = (-R45) which defines R value as a function of plastic strain (Curve) or as a function of temperature and plastic strain (Table). See Remarks 2 and 3.
R90	R ₉₀ , Lankford parameter in 90 degree direction GT.0.0: Constant value, LT.0.0: Load curve or Table ID = (-R90) which defines R value as a function of plastic strain (Curve) or as a function of temperature and plastic strain (Table). See Remarks 2 and 3.
AH	a, Hill90 parameter, which is read instead of R00 if FLAG = 1.
BH	b, Hill90 parameter, which is read instead of R45 if FLAG = 1.
CH	c, Hill90 parameter, which is read instead of R90 if FLAG = 1.

VARIABLE	DESCRIPTION
LCID	Load curve/table ID for hardening in the 0 degree direction. See Remark 1.
E0	<p>Material parameter</p> <p>HR.EQ.2.0: ϵ_0 for determining initial yield stress for Swift exponential hardening. (Default = 0.0)</p> <p>HR.EQ.4.0: b, coefficient for Voce exponential hardening</p> <p>HR.EQ.5.0: ϵ_0 for determining initial yield stress for Gosh exponential hardening. (Default = 0.0)</p> <p>HR.EQ.6.0: b, coefficient for Hockett-Sherby exponential hardening</p>
SPI	<p>if ϵ_0 is zero above and HR = 2.0. (Default = 0.0)</p> <p>EQ.0.0: $\epsilon_0 = (E/k)^{1/(n-1)}$</p> <p>LE.0.02: $\epsilon_0 = \text{SPI}$</p> <p>GT.0.02: $\epsilon_0 = (\text{SPI}/k)^{1/n}$</p> <p>If HR = 5.0 the strain at plastic yield is determined by an iterative procedure based on the same principles as for HR.EQ.2.0.</p>
P3	<p>Material parameter:</p> <p>HR.EQ.5.0: p, parameter for Gosh exponential hardening</p> <p>HR.EQ.6.0: n, exponent for Hockett-Sherby exponential hardening</p>
AOPT	<p>Material axes option (see MAT_OPTIONTROPIC_ELASTIC for a more complete description):</p> <p>EQ.0.0: locally orthotropic with material axes determined by element nodes 1, 2, and 4, as with *DEFINE_COORDINATE_NODES, and then rotated about the shell element normal by the angle BETA.</p> <p>EQ.2.0: globally orthotropic with material axes determined by vectors defined below, as with *DEFINE_COORDINATE_VECTOR.</p> <p>EQ.3.0: locally orthotropic material axes determined by rotating the material axes about the element normal by an angle, BETA, from a line in the plane of the element defined by the cross product of the vector v with the element nor-</p>

VARIABLE	DESCRIPTION
	mal.
	LT.0.0: the absolute value of AOPT is a coordinate system ID number (CID on *DEFINE_COORDINATE_NODES, *DEFINE_COORDINATE_SYSTEM or *DEFINE_COORDINATE_VECTOR). Available with the R3 release of Version 971 and later.
C	C in Cowper-Symonds strain rate model
P	p in Cowper-Symonds strain rate model, p = 0.0 for no strain rate effects
VLCID	Volume correction curve ID defining the relative volume change (change in volume relative to the initial volume) as a function of the effective plastic strain. This is only used when nonzero. See Remark 1.
FLAG	Flag for interpretation of parameters. If FLAG = 1, parameters AH, BH, and CH are read instead of R00, R45, and R90. See Remark 4.
XP, YP, ZP	Coordinates of point p for AOPT = 1.
A1, A2, A3	Components of vector a for AOPT = 2.
V1, V2, V3	Components of vector v for AOPT = 3.
D1, D2, D3	Components of vector d for AOPT = 2.
BETA	Material angle in degrees for AOPT = 0 and 3, may be overridden on the element card, see *ELEMENT_SHELL_BETA.
USRFAIL	User defined failure flag USRFAIL.EQ.0: no user subroutine is called USRFAIL.EQ.1: user subroutine matusr_24 in dyn21.f is called

Remarks:

1. The effective plastic strain used in this model is defined to be plastic work equivalent. A consequence of this is that for parameters defined as functions of effective plastic strain, the rolling (00) direction should be used as reference direction. For instance, the hardening curve for HR = 3 is the stress as function of strain for uniaxial tension in the rolling direction, VLCID curve should give the relative volume change as function of strain for uniaxial tension in the rolling direction and load

curve given by -E should give the Young's modulus as function of strain for uniaxial tension in the rolling direction. Optionally the curve can be substituted for a table defining hardening as function of plastic strain rate (HR = 3) or temperature (HR = 8).

2. Exceptions from the rule above are curves defined as functions of plastic strain in the 45 and 90 directions, i.e., P1 and P2 for HR = 7 and negative R45 or R90. The hardening curves are here defined as measured stress as function of measured plastic strain for uniaxial tension in the direction of interest, i.e., as determined from experimental testing using a standard procedure. Moreover, the curves defining the R values are as function of the measured plastic strain for uniaxial tension in the direction of interest. These curves are transformed internally to be used with the effective stress and strain properties in the actual model. The effective plastic strain does not coincide with the plastic strain components in other directions than the rolling direction and may be somewhat confusing to the user. Therefore the von Mises work equivalent plastic strain is output as history variable #2 if HR = 7 or if any of the R-values is defined as function of the plastic strain.
3. The R-values in curves are defined as the ratio of instantaneous width change to instantaneous thickness change. That is, assume that the width W and thickness T are measured as function of strain. Then the corresponding R-value is given by:

$$R = \frac{\frac{dW}{d\varepsilon}/W}{\frac{dT}{d\varepsilon}/T}$$

4. The anisotropic yield criterion Φ for plane stress is defined as:

$$\Phi = K_1^m + K_3 \cdot K_2^{(m/2)-1} + c^m \cdot K_4^{m/2} = (1 + c^m - 2a + b)\sigma_Y^m$$

where σ_Y is the yield stress and $K_i = 1,4$ are given by:

$$K_1 = |\sigma_x + \sigma_y|$$

$$K_2 = |\sigma_x^2 + \sigma_y^2 + 2\sigma_{xy}^2|$$

$$K_3 = -2a(\sigma_x^2 - \sigma_y^2) + b(\sigma_x - \sigma_y)^2$$

$$K_4 = |(\sigma_x - \sigma_y)^2 + 4\sigma_{xy}^2|$$

If FLAG = 0, the anisotropic material constants a, b, and c are obtained through R_{00} , R_{45} , and R_{90} using these 3 equations:

$$1 + 2R_{00} = \frac{c^m - a + \{(m+2)/2m\}b}{1 - a + \{(m-2)/2m\}b}$$

$$1 + 2R_{45} = c^m$$

$$1 + 2R_{90} = \frac{c^m + a + \{(m+2)/2m\}b}{1 + a + \{(m-2)/2m\}b}$$

If FLAG = 1, material parameters a (AH), b (BH), and c (CH) are used directly.

For material parameters a, b, c, and m, the following condition has to be fulfilled, otherwise an error termination occurs:

$$1 + c^m - 2a + b > 0$$

Two even more strict conditions should ensure convexity of the yield surface according to Hill (1990). A warning message will be dumped if at least one of them is violated:

$$b > -2\left(\frac{m}{2}\right)^{-1} c^m$$

$$b > a^2 - c^m$$

The yield strength of the material can be expressed in terms of k and n:

$$\sigma_Y = k\varepsilon^n = k(\varepsilon_{yp} + \bar{\varepsilon}^p)^n$$

where ε_{yp} is the elastic strain to yield and $\bar{\varepsilon}^p$ is the effective plastic strain (logarithmic). If SIGY is set to zero, the strain to yield is found by solving for the intersection of the linearly elastic loading equation with the strain hardening equation:

$$\sigma = E\varepsilon$$

$$\sigma = k\varepsilon^n$$

which gives the elastic strain at yield as:

$$\varepsilon_{yp} = \left(\frac{E}{k}\right)^{\left[\frac{1}{n-1}\right]}$$

If SIGY yield is nonzero and greater than 0.02 then:

$$\varepsilon_{yp} = \left(\frac{\sigma_Y}{k}\right)^{\left[\frac{1}{n}\right]}$$

The other available hardening models include the Voce equation given by

$$\sigma_Y(\varepsilon_p) = a - be^{-c\varepsilon_p},$$

the Gosh equation given by

$$\sigma_Y(\varepsilon_p) = k(\varepsilon_0 + \varepsilon_p)^n - p,$$

and finally the Hockett-Sherby equation given by

$$\sigma_Y(\varepsilon_p) = a - be^{-c\varepsilon_p^n}.$$

For the Gosh hardening law, the interpretation of the variable SPI is the same, i.e., if set to zero the strain at yield is determined implicitly from the intersection of the strain hardening equation with the linear elastic equation.

To include strain rate effects in the model we multiply the yield stress by a factor depending on the effective plastic strain rate. We use the Cowper-Symonds' model, hence the yield stress can be written

$$\sigma_Y(\varepsilon_p, \dot{\varepsilon}_p) = \sigma_Y^s(\varepsilon_p) \left\{ 1 + \left(\frac{\dot{\varepsilon}_p}{C} \right)^{1/p} \right\}$$

where σ_Y^s denotes the static yield stress, C and p are material parameters, $\dot{\varepsilon}_p$ is the effective plastic strain rate.

5. A kinematic hardening model is implemented following the works of Chaboche and Roussilier. A back stress α is introduced such that the effective stress is computed as

$$\sigma_{\text{eff}} = \sigma_{\text{eff}}(\sigma_{11} - 2\alpha_{11} - \alpha_{22}, \sigma_{22} - 2\alpha_{22} - \alpha_{11}, \sigma_{12} - \alpha_{12})$$

The back stress is the sum of up to four terms according to

$$\alpha_{ij} = \sum_{k=1}^4 \alpha_{ij}^k$$

and the evolution of each back stress component is as follows

$$\delta \alpha_{ij}^k = C_k \left(a_k \frac{s_{ij}}{\sigma_{\text{eff}}} - \alpha_{ij}^k \right) \delta \varepsilon_p$$

where C_k and a_k are material parameters, s_{ij} is the deviatoric stress tensor, σ_{eff} is the effective stress and ε_p is the effective plastic strain.

***MAT_UHS_STEEL**

This material model is developed for both shell and solid models. It is mainly suited for hot stamping processes where phase transformations are crucial. It has five phases and it is assumed that the blank is fully austenitized before cooling. The basic constitutive model is based on the work done by P. Akerstrom [2, 7].

Automatic switching between cooling and heating of the blank is under development. To activate the heating algorithm you need to set HEAT = 1 or 2 and add the appropriate input Cards. See the description of the HEAT parameter below. HEAT = 0 as is the default activates only the cooling algorithm and no extra cards need to be read in. Also note that for HEAT = 0 you **must** check that the initial temperature of this material is above the start temperature for the ferrite transformation. The transformation temperatures are echoed in the message and in the d3hsp file.

If HEAT > 0 the temperature that instantaneous transform all ferrite back to austenite is also echoed in the message file. If you want to heat up to 100% austenite you must let the specimen's temperature exceed that temperature.

If you are new to this material model please read the Remarks section where some of the parameters are explained in more detail.

New advanced features:

1. Young's modulus and Poisson ratio can now be given as temperature dependent load curves or by a table definition with a load curve for each phase (Remark 7).
2. Latent heat can now be given for each phase (Remark 8).
3. Thermal expansion can now be given for each phase (Remark 9).
4. Advanced reaction kinetic modifications includes the ability to tailor the start temperatures and the activation energies. The Martensite start temperature can be dependent on the plastic strain and triaxiality, and the activation energies can be scaled with the plastic strain as well.
5. Hardness calculation improved when tempering is active. Improvements are achieved in the bainite and martensite phases (experimental) (Remark 10).

NOTE: For this material "weight%" means "ppm × 10 ⁻⁴ ".

Card 1	1	2	3	4	5	6	7	8
Variable	MID	RO	E	PR	TUNIT	CRSH	PHASE	HEAT
Type	I	F	F	F	F	I	I	I
Defaults	none	none	none	none	3600	0	0	0

Card 2	1	2	3	4	5	6	7	8
Variable	LCY1	LCY2	LCY3	LCY4	LCY5	KFER	KPER	B
Type	I	I	I	I	I	F	F	F
Defaults	none	none	none	none	none	0.0	0.0	0.0

Card 3	1	2	3	4	5	6	7	8
Variable	C	Co	Mo	Cr	Ni	Mn	Si	V
Type	F	F	F	F	F	F	F	F
Defaults	0.0	0.0	0.0	0.0	0.0	0.0	0.0	0.0

Card 4	1	2	3	4	5	6	7	8
Variable	W	Cu	P	Al	As	Ti		
Type	F	F	F	F	F	F		
Defaults	0.0	0.0	0.0	0.0	0.0	0.0		

Card 5	1	2	3	4	5	6	7	8
Variable	THEXP1	THEXP5	LCTH1	LCTH5	TREF	LAT1	LAT5	TABTH
Type	F	F	I	I	F	F	F	I
Defaults	0.0	0.0	none	none	273.15	0.0	0.0	none

Card 6	1	2	3	4	5	6	7	8
Variable	QR2	QR3	QR4	ALPHA	GRAIN	TOFFE	TOFPE	TOFBA
Type	F	F	F	F	F	F	F	F
Defaults	0.0	0.0	0.0	0.0	0.0	0.0	0.0	0.0

Card 7	1	2	3	4	5	6	7	8
Variable	PLMEM2	PLMEM3	PLMEM4	PLMEM5	STRC	STRP	REACT	TEMPER
Type	I	F	F	F	F	F	I	I
Defaults	0.0	0.0	0.0	0.0	0.0	0.0	0	0

Heat Card 1. Additional Card for HEAT = 1.

Card 8	1	2	3	4	5	6	7	8
Variable	AUST	FERR	PEAR	BAIN	MART	GRK	GRQR	TAU1
Type	F	F	F	F	F	F	F	F
Default	0.0	0.0	0.0	0.0	0.0	0.0	0.0	2.08E+8

Heat Card 2. Additional Card for HEAT =1.

Card 9	1	2	3	4	5	6	7	8
Variable	GRA	GRB	EXPA	EXPB	GRCC	GRCM	HEATN	TAU2
Type	F	F	F	F	F	F	F	F
Default	3.11	7520.	1.0	1.0	none	none	1.0	4.806

Reaction Card. Addition card for REACT = 1.

Card 10	1	2	3	4	5	6	7	8
Variable	FS	PS	BS	MS	MSIG	LCEPS23	LCEPS4	LCEPS5
Type	F	F	F	F	F	I	I	I
Default	0.0	0.0	0.0	0.0	none	none	none	none

Tempering Card. Additional card for TEMPR = 1.

Card 11	1	2	3	4	5	6	7	8
Variable	LCH4	LCH5	DTCRIT	TSAMP				
Type	I	I	F	F				
Default	0	0	0.0	0.0				

VARIABLE	DESCRIPTION	BASELINE VALUE
MID	Material ID, a unique number has to be chosen.	
RO	Material density	7830 Kg/m ³

VARIABLE	DESCRIPTION	BASELINE VALUE
E	<p>Youngs' modulus:</p> <p>GT.0.0: constant value is used</p> <p>LT.0.0: LCID or TABID. Temperature dependent Youngs' modulus given by load curve ID = -E or a Table ID = -E. When using a table to describe the Youngs modulus see Remark 7 for more information.</p>	100.e+09 Pa [1]
PR	<p>Poisson's ratio:</p> <p>GT.0.0: constant value</p> <p>LT.0.0: LCID or TABID: Temperature dependent Poisson ratio given by load curve or table ID = -PR. The table input is described in Remark 7.</p>	0.30 [1]
TUNIT	<p>Number of time units per hour. Default is seconds, that is 3600 time units per hour. It is used only for hardness calculations.</p>	3600.
CRSH	<p>Switch to use a simple and fast material model but with the actual phases active.</p> <p>EQ.0: The original model were phase transitions are active and trip is used.</p> <p>EQ.1: A simpler and faster version. This option is mainly when transferring the quenched blank into a crash analysis where all properties from the cooling are maintained. This option must be used with a *INTERFACE_SPRINGBACK keyword and should be used after a quenching analysis.</p> <p>EQ.2: Same as 0 but trip effect is not used.</p>	0

VARIABLE	DESCRIPTION	BASELINE VALUE
PHASE	Switch to exclude middle phases from the simulation. EQ.0: All phases ACTIVE default) EQ.1: pearlite and bainite ACTIVE EQ.2: bainite ACTIVE EQ.3: ferrite and pearlite ACTIVE EQ.4: ferrite and bainite ACTIVE EQ.5: NO ACTIVE middle phases (only austenite -> martensite)	0
HEAT	Switch to activate the heating algorithms EQ.0: Heating is not activated. That means that no transformation to Austenite is possible. EQ.1: Heating is activated: That means that only transformation to Austenite is possible. EQ.2: Automatic switching between cooling and heating. LS-DYNA checks the temperature gradient and calls the appropriate algorithms. For example, this can be used to simulate the heat affected zone during welding. LT.0: Switch between cooling and heating is defined by a time dependent load curve with id ABS(HEAT). The ordinate should be 1.0 when heating is applied and 0.0 if cooling is preferable.	

VARIABLE	DESCRIPTION	BASELINE VALUE
LCY1	<p>Load curve or Table ID for austenite hardening.</p> <p><u>IF LCID</u></p> <p>input yield stress versus effective plastic strain.</p> <p><u>IF TABID.GT.0:</u></p> <p>2D table. Input temperatures as table values and hardening curves as targets for those temperatures (see *DEFINE_TABLE)</p> <p><u>IF TABID.LT.0:</u></p> <p>3D table. Input temperatures as main table values and strain rates as values for the sub tables, and hardening curves as targets for those strain rates.</p>	[5]
LCY2	Load curve ID for ferrite hardening (stress versus eff. pl. str.)	
LCY3	Load curve or Table ID for pearlite. See LCY1 for description.	
LCY4	Load curve or Table ID for bainite. See LCY1 for description.	
LCY5	Load curve or Table ID for martensite. See LCY1 for description.	
KFERR	Correction factor for boron in the ferrite reaction.	1.9e+05 [2]
KPEAR	Correction factor for boron in the pearlite reaction.	3.1e+03 [2]
B	Boron [weight %]	0.003 [2, 4]
C	Carbon [weight %]	0.23 [2, 4]
Co	Cobolt [weight %]	0.0 [2, 4]
Mo	Molybdenum [weight %]	0.0 [2, 4]
Cr	Chromium [weight %]	0.21 [2, 4]
Ni	Nickel [weight %]	0.0 [2, 4]

VARIABLE	DESCRIPTION	BASELINE VALUE
Mn	Manganese [weight %]	1.25 [2, 4]
Si	Silicon [weight %]	0.29 [2, 4]
V	Vanadium [weight %]	0.0 [2, 4]
W	Tungsten [weight %]	0.0
Cu	copper [weight %]	0.0
P	Phosphorous [weight %]	0.013
Al	Aluminium [weight %]	0.0
As	Arsenic [weight %]	0.0
Ti	Titanium [weight %]	0.0
THEXP1	Coefficient of thermal expansion in austenite	25.1e-06 1/K [7]
THEXP5	Coefficient of thermal expansion in martensite	11.1e-06 1/K [7]
LCTH1	Load curve for the thermal expansion coefficient for austenite: LT.0.0: curve ID = -LA and TREF is used as reference temperature GT.0.0: curve ID = LA	0
LCTH5	Load curve for the thermal expansion coefficient for martensite: LT.0.0: curve ID = -LA and TREF is used as reference temperature GT.0.0: curve ID = LA	0
TREF	Reference temperature for thermal expansion. Used if and only if LA.LT.0.0 or/and LM.LT.0.0	293.15
LAT1	Latent heat for the decomposition of austenite into ferrite, pearlite and bainite. GT.0.0: Constant value LT.0.0: Curve ID or Table ID: See remark 8 for more information.	590.e+06 J/m ³ [2]

VARIABLE	DESCRIPTION	BASELINE VALUE
LAT5	Latent heat for the decomposition of austenite into martensite. GT.0.0: Constant value LT.0.0: Curve ID:Note that LAT 5 is ignored if a Table ID is used in LAT1.	640.e+06 J/m ³ [2]
TABTH	Table definition for thermal expansion. With this option active THEXP1, THEXP2, LCTH1 and LCTH5 are ignored. See remarks for more information how to input this table. GT.0: A table for instantaneous thermal expansion (TREF is ignored). LT.0: A table with thermal expansion with reference to TREF.	
QR2	Activation energy divided by the universal gas constant for the diffusion reaction of the austenite-ferrite reaction: Q2/R. R = 8.314472 [J/mol K].	10324 K [3] = (23000 cal/mole) × (4.184 J/cal) / (8.314 J/mole/K)
QR3	Activation energy divided by the universal gas constant for the diffusion reaction for the austenite-pearlite reaction: Q3/R. R = 8.314472 [J/mol K].	13432. K [3]
QR4	Activation energy divided by the universal gas constant for the diffusion reaction for the austenite-bainite reaction: Q4/R. R = 8.314472 [J/mol K].	15068. K [3]
ALPHA	Material constant for the martensite phase. A value of 0.011 means that 90% of the available austenite is transformed into martensite at 210 degrees below the martensite start temperature (see messag file for information), whereas a value of 0.033 means a 99.9% transformation.	0.011
GRAIN	ASTM grain size number for austenite, usually a number between 7 and 11.	6.8
TOFFE	Number of degrees that the ferrite is bleeding over into the pearlite reaction.	0.0

<u>VARIABLE</u>	<u>DESCRIPTION</u>	<u>BASELINE VALUE</u>
TOFPE	Number of degrees that the pearlite is bleeding over into the bainite reaction	0.0
TOFBA	Number of degrees that the bainite is bleeding over into the martensite reaction.	0.0
PLMEM2	Memory coefficient for the plastic strain that is carried over from the austenite. A value of 1 means that all plastic strains from austenite is transferred to the <i>ferrite</i> phase and a value of 0 means that nothing is transferred.	0.0
PLMEM3	Same as PLMEM2 but between austenite and pearlite.	0.0
PLMEM4	Same as PLMEM2 but between austenite and bainite.	0.0
PLMEM5	Same as PLMEM3 but between austenite and martensite.	0.0
STRC	Effective strain rate parameter C. STRC.LT.0.0: load curve id = -STRC STRC.GT.0.0: constant value STRC.EQ.0.0: strain rate NOT active	0.0
STRP	Effective strain rate parameter P. STRP.LT.0.0: load curve id = -STRP STRP.GT.0.0: constant value STRP.EQ.0.0: strain rate NOT active	0.0
REACT	Flag for advanced reaction kinetics input. One additional input card is read. EQ.1.0: Active EQ.0.0: Inactive	0.0
TEMPER	Flag for tempering input. One additional input card is read. EQ.1.0: Active EQ.0.0: Inactive	0.0

VARIABLE	DESCRIPTION	BASELINE VALUE
AUST	If a heating process is initiated at $t = 0$ this parameters sets the initial amount of austenite in the blank. If heating is activated at $t > 0$ during a simulation this value is ignored. Note that, $\text{AUST} + \text{FERR} + \text{PEAR} + \text{BAIN} + \text{MART} = 1.0$	0.0
FERR	See AUST for description	0.0
PEAR	See AUST for description	0.0
BAIN	See AUST for description	0.0
MART	See AUST for description	0.0
GRK	Growth parameter k ($\mu\text{m}^2/\text{sec}$)	1.0E+11[9]
GRQR	Grain growth activation energy (J/mol) divided by the universal gas constant. Q/R where $R = 8.314472$ (J/mol K)	3.0E+4[9]
TAU1	Empirical grain growth parameter c_1 describing the function $\tau(T)$	2.08E+8 [9]
GRA	Grain growth parameter A	[9]
GRB	Grain growth parameter B. A table of recommended values of GRA and GRB is included in Remark 7.	[9]
EXPA	Grain growth parameter a	1.0 [9]
EXPB	Grain growth parameter b	1.0 [9]
GRCC	Grain growth parameter with the concentration of non metals in the blank, weight% of C or N	[9]
GRCM	Grain growth parameter with the concentration of metals in the blank, lowest weight% of Cr, V, Nb, Ti, Al.	[9]
HEATN	Grain growth parameter n for the austenite formation	1.0[9]
TAU2	Empirical grain growth parameter c_2 describing the function $\tau(T)$	4.806[9]

<u>VARIABLE</u>	<u>DESCRIPTION</u>	<u>BASELINE VALUE</u>
FS	Manual start temperature Ferrite	
PS	Manual start temperature Pearlite	
BS	Manual start temperature Bainite	
MS	Manual start temperature Martensite	
MSIG	<p>Describes the increase of martensite start temperature due to applied stress.</p> <p>LT.0: Load Curve ID describes MSIG as a function of triaxiality (pressure / effective stress).</p> $MS^* = MS + MSIG \times \sigma_{eff}$	
LCEPS23	<p>Load Curve ID dependent on plastic strain that scales the activation energy QR2 and QR3.</p> $QRx = Qx \times CEPS23(\epsilon_{pl}) / R$	
LCEPS4	<p>Load Curve ID dependent on plastic strain that scales the activation energy QR4.</p> $QR4 = Q4 \times LCEPS4(\epsilon_{pl}) / R$	
LCEPS5	<p>Load Curve ID which describe the increase of the martensite start temperature as a function of plastic strain.</p> $MS^* = MS + MSIG \times \sigma_{eff} + LCEPS5(\epsilon_{pl})$	
LCH4	Load curve ID of Vicker hardness vs. temperature for Bainite hardness calculation.	
LCH5	Load curve ID of Vicker hardness vs. temperature for Martensite hardness calculation.	
DTCRIT	Critical cooling rate to detect holding phase.	
TSAMP	Sampling interval for temperature rate monitoring to detect the holding phase	

Discussion:

The phase distribution during cooling is calculated by solving the following rate equation for each phase transition

$$\dot{X}_k = g_k(G, C, T_k, Q_k) f_k(X_k), \quad k = 2,3,4$$

where g_k is a function, taken from Li et al., dependent on the grain number G , the chemical composition C , the temperature T and the activation energy Q . Moreover, the function f is dependent on the actual phase $X_k = x_k/x_{eq}$

$$f_k(X_k) = X_k^{0.4(X_k-1)} (1 - X_k)^{0.4X_k}, \quad k = 2,3,4$$

The true amount of martensite, i.e., $k = 5$, is modelled by using the true amount of the austenite left after the bainite phase:

$$x_5 = x_1 [1 - e^{-\alpha(MS-T)}],$$

where x_1 is the true amount of austenite left for the reaction, α is a material dependent constant and MS is the start temperature of the martensite reaction.

The start temperatures are automatically calculated based on the composition:

1. Ferrite,

$$FS(K) = 1185 - 203\sqrt{C} - 15.2Ni + 44.7Si + 104V + 31.5Mo + 13.1W - 30Mn - 11Cr \\ - 20Cu + 700P + 400Al + 120As + 400Ti$$

2. Pearlite,

$$PS(K) = 996 - 10.7Mn - 16.9Ni + 29Si + 16.9Cr + 290As + 6.4W$$

3. Bainite,

$$BS(K) = 910 - 58C - 35Mn - 15Ni - 34Cr - 41Mo$$

4. Martensite,

$$MS(K) = 812 - 423C - 30.4Mn - 17.7Ni - 12.1Cr - 7.5Mo + 10Co - 7.5Si$$

The automatic start temperatures are printed to the *messag* file and if they are not accurate enough you can manually set them in the input deck (must be set in absolute temperature, Kelvin). If $HEAT > 0$, the temperature $FSnc$ (ferrite without C) is also echoed. If the specimen exceeds that temperature all ferrite that is left is instantaneous transformed to austenite.

Remarks:

1. History variables 1-8 include the different phases, the Vickers hardness, the yield stress and the ASTM grain size number. Set NEIPS = 8 (shells) or NEIPH = 8 (solids) on *DATABASE_EXTENT_BINARY.

History Variable	Description
1	Amount austenite
2	Amount ferrite
3	Amount pearlite
4	Amount bainite
5	Amount martensite
6	Vickers hardness
7	Yield stress
8	ASTM grain size number (a low value means large grains and vice versa)

2. To exclude a phase from the simulation, set the PHASE parameter accordingly.
3. Note that both strain rate parameters must be set to include the effect. It is possible to use a temperature dependent load curve for both parameters simultaneously or for one parameter keeping the other constant.
4. TUNIT is time units per hour and is only used for calculating the Vicker Hardness, as default it is assumed that the time unit is seconds. If other time unit is used, for example milli seconds, then TUNIT must be changed to $TUNIT = 3.6 \times 10^6$
5. The thermal speedup factor TSF of *CONTROL_THERMAL_SOLVER is used to scale reaction kinetics and hardness calculations in this material model. On the other hand, strain rate dependent properties (see LCY1 to LCY5 or STRC/STRP) are not scaled by TSF.
6. With the CRSH = 1 option it is now possible to transfer the material properties from a hot stamping simulation (CRSH = 0) into another simulation. The CRSH = 1 option reads a *dynain* file from a simulation with CRSH = 0 and keeps all the history variables (austenite, ferrite, pearlite, bainite, martensite, etc) constant. This will allow steels with inhomogeneous strength to be analysed in, for example, a crash simulation. The speed with the CRSH = 1 option is comparable with *MAT_024. Note that for keeping the speed the temperature used in the CRSH simulation should be constant and the thermal solver should be inactive.

- 7. When HEAT is activated the re-austenitization and grain growth algorithms are also activated. The grain growth is activated when the temperature exceeds a threshold value that is given by

$$T = \frac{B}{A - \log_{10}[(GRCM)^a(GRCC)^b]}$$

and the rate equation for the grain growth is,

$$\dot{g} = \frac{k}{2g} e^{-\frac{Q}{RT}}$$

The rate equation for the phase re-austenitization is given in Oddy (1996) and is here mirrored

$$\dot{x}_a = n \left[\ln \left(\frac{x_{eu}}{x_{eu} - x_a} \right) \right]^{\frac{n-1}{n}} \left[\frac{x_{eu} - x_a}{\tau(T)} \right]$$

where n is the parameter HEATN. The temperature dependent function $\tau(T)$ is given from Oddy as $\tau(T) = c_1(T - T_s)^{c_2}$. The empirical parameters c_1 and c_2 are calibrated in Oddy to 2.06E+8 and 4.806 respectively. Note that τ above given in **seconds**.

Recommended values for GRA and GRB are given in the following table.

Compound	Metal	Non-metal	GRA	GRB
Cr ₂₃ C ₆	Cr	C	5.90	7375
V ₄ C ₃	V	C _{0.75}	5.36	8000
TiC	Ti	C	2.75	7000
NbC	Nb	C _{0.7}	3.11	7520
Mo ₂ C	Mo	C	5.0	7375
Nb(CN)	Nb	(CN)	2.26	6770
VN	V	N	3.46+0.12%Mn	8330
AlN	Al	N	1.03	6770
NbN	Nb	N	4.04	10230
TiN	Ti	N	0.32	8000

- 8. When using a Table ID for describing the Youngs modulus as dependent on the temperature. Use *DEFINE_TABLE_2D and set the abscissa value equal to '1' for the austenite YM-curve, equal to '2' for the ferrite YM-curve, equal to '3' for the

pearlite YM curve, equal to '4' for the bainite YM-curve and finally equal to '5' for the martensite YM-curve. If you use the PHASE option you only need to define the curves for the included phases, but you can define all five. LS-DYNA uses the number 1-5 to get the right curve for the right phase. The total YM is calculated by a linear mixture law: $YM = YM1 \times PHASE1 + \dots + YM5 \times PHASE5$. For example:

```
*DEFINE_TABLE_2D
$ The number before curve id:s define which phase the curve
$ will be applied to. 1 = Austenite, 2 = Ferrite, 3 = Pearlite,
$ 4 = Bainite and 5 = Martensite.
      1000      0.0      0.0
              1.0              100
              2.0              200
              3.0              300
              4.0              400
              5.0              500

$
$ Define curves 100 - 500
*DEFINE_CURVE
$ Austenite Temp (K) - YM-Curve (MPa)
      100      0      1.0      1.0
      1300.0      50.E+3
      223.0      210.E+3
```

9. When using a Table ID for the Latent heat (LAT1) you can describe all phase transition individually. Use *DEFINE_TABLE_2D and set the abscissa values to the corresponding phase transition number. That is, '2' for the Austenite – Ferrite, '3' for the Austenite – Pearlite, '4' for the Austenite – Bainite and '5' for the Austenite – Martensite. See Remark 7 for an example of a correct table definition. If a curve is missing, the corresponding latent heat for that transition will be set to zero. Also, when a table is used the LAT2 is ignored. If HEAT.GT.0 you also have the option to include latent heat for the transition back to Austenite. This latent heat curve is marked as '1' in the table definition of LAT1.
10. When using a Table ID for the Thermal expansion you can tailor the expansion for each phase. That is, you can have a curve for each of the 5 phases (austenite, ferrite, pearlite, bainite and martensite). The input is identical to the above table definitions. The Table must have the abscissa values between '1' and '5' where the number correspond to phase '1' to '5'. To exclude one phase from influencing the thermal expansion you simply input a curve that is zero for that phase or even easier, exclude that phase number in the table definition. For example to exclude the bainite phase you only define the table with curves for the indices '1', '2', '3' and '5'.
11. When TEMPERING is activated with TEMPER = 1 the original hardness calculation for Bainite and Martensite are changed to an incremental update formula. The total hardness is given by $\sum_{i=1}^5 HV_i \times x_i$. When holding phases are detected the hardness for Bainite and Martensite is updated according to

$$HV_4^{n+1} = \frac{x_4^n}{x_4^{n+1}} HV_4^n + \frac{\Delta x_4}{x_4^{n+1}} h_4(T), \quad \Delta x_4 = x_4^{n+1} - x_4^n$$

$$HV_5^{n+1} = \frac{x_5^n}{x_5^{n+1}} HV_5^n + \frac{\Delta x_5}{x_5^{n+1}} h_5(T), \quad \Delta x_5 = x_5^{n+1} - x_5^n$$

We detect the holding phase for Bainite and Martensite when the temperature is in the appropriate range and if average temperature rate is below DTCRIT. The average temperature rate is calculated as $\frac{T_{\text{tresh}}}{t_{\text{tresh}}}$ where the $T_{\text{tresh}}^{n+1} = T_{\text{tresh}}^n + |\dot{T}|\Delta t$ and $t_{\text{tresh}}^{n+1} = t_{\text{tresh}}^n + \Delta t$. The average temperature and time are updated until $t_{\text{tresh}} \geq t_{\text{samp}}$.

References:

1. Numisheet 2008 Proceedings, The Numisheet 2008 Benchmark Study, Chapter 3, Benchmark 3, Continuous Press Hardening, Interlaken, Switzerland, Sept. 2008.
2. P. Akerstrom and M. Oldenburg, "Austenite Decomposition During Press hardening of a Boron Steel – Computer Simulation and Test", Journal of Material processing technology, 174 (2006), pp399-406.
3. M.V Li, D.V Niebuhr, L.L Meekisho and D.G Atteridge, "A Computatinal model for te prediction of steel hardenability", Metallurgical and materials transactions B, 29B, 661-672, 1998.
4. D.F. Watt, "An Algorithm for Modelling Microstructural Development in Weld heat-Affected Zones (Part A) Reaction Kinetics", Acta metal. Vol. 36., No. 11, pp. 3029-3035, 1988.
5. ThyssenKrupp Steel, "Hot Press hardening Manganese-boron Steels MBW", product information Manganese-boron Steels, Sept. 2008.
6. Malek Naderi, "Hot Stamping of Ultra High Strength Steels", Doctor of Engineering Dissertation, Technical University Aachen, Germany, 2007.
7. P. Akerstrom, "Numerical Implementation of a Constitutive model for Simulation of Hot Stamping", Division of Solid Mechanics, Lulea University of technology, Sweden.
8. Malek Naderi, "A numerical and Experimental Investigation into Hot Stamping of Boron Alloyed Heat treated Steels", Steel research Int. 79 (2008) No. 2.
9. A.S. Oddy, J.M.J. McDill and L. Karlsson, "Microstructural predictions including arbitrary thermal histories, reaustenitization and carbon segregation effects" (1996).

Boron steel composition from the literature:

Element	HAZ code	Akerstrom (2)	Naderi (8)	ThyssenKrupp(4) (max amount)
B		0.003	0.003	0.005
C	0.168	0.23	0.230	0.250
Co				
Mo	0.036			0.250
Cr	0.255	0.211	0.160	0.250
Ni	0.015			
Mn	1.497	1.25	1.18	1.40
Si	0.473	0.29	0.220	0.400
V	0.026			
W				
Cu	0.025			
P	0.012	0.013	0.015	0.025
Al	0.020			
As				
Ti			0.040	0.05
S		0.003	0.001	0.010

***MAT_PML_{OPTION}TROPIC_ELASTIC**

This is Material Type 245. This is a perfectly-matched layer (PML) material for orthotropic or anisotropic media, to be used in a wave-absorbing layer adjacent to an orthotropic/anisotropic material (*MAT_{OPTION}TROPIC_ELASTIC) in order to simulate wave propagation in an unbounded ortho/anisotropic medium.

This material is a variant of MAT_PML_ELASTIC (MAT_230) and is available only for solid 8-node bricks (element type 2). The input cards exactly follow *MAT_{OPTION}TROPIC_ELASTIC as shown below. See the variable descriptions and Remarks section of *MAT_{OPTION}TROPIC_ELASTIC (*MAT_002) for further details.

Available options include:

ORTHO

ANISO

such that the keyword cards appear:

*MAT_PML_ORTHOTROPIC_ELASTIC or MAT_245 (4 cards follow)

*MAT_PML_ANISOTROPIC_ELASTIC or MAT_245_ANISO (5 cards follow)

Orthotropic Card 1. Card 1 format used for ORTHO keyword option.

Card 1	1	2	3	4	5	6	7	8
Variable	MID	RO	EA	EB	EC	PRBA	PRCA	PRCB
Type	A8	F	F	F	F	F	F	F

Orthotropic Card 2. Card 1 format used for ORTHO keyword option.

Card 2	1	2	3	4	5	6	7	8
Variable	GAB	GBC	GCA	AOPT	G	SIGF		
Type	F	F	F	F	F	F		

Anisotropic Card 1. Card 1 format used for ANISO keyword option.

Card 1	1	2	3	4	5	6	7	8
Variable	MID	R0	C11	C12	C22	C13	C23	C33
Type	A8	F	F	F	F	F	F	F

Anisotropic Card 2. Card 2 format used for ANISO keyword option.

Card 2	1	2	3	4	5	6	7	8
Variable	C14	C24	C34	C44	C15	C25	C35	C45
Type	F	F	F	F	F	F	F	F

Anisotropic Card 1. Additional card for ANISO keyword option.

Card 3	1	2	3	4	5	6	7	8
Variable	C55	C16	C26	C36	C46	C56	C66	AOPT
Type	F	F	F	F	F	F	F	F

Card 4	1	2	3	4	5	6	7	8
Variable	XP	YP	ZP	A1	A2	A3	MACF	
Type	F	F	F	F	F	F	I	

Card 5	1	2	3	4	5	6	7	8
Variable	V1	V2	V3	D1	D2	D3	BETA	REF
Type	F	F	F	F	F	F	F	F

Remarks:

1. A layer of this material may be placed at a boundary of a bounded domain to simulate unboundedness of the domain at that boundary: the layer absorbs and attenuates waves propagating outward from the domain, without any significant reflection of the waves back into the bounded domain. The layer cannot support any static displacement.
2. It is assumed the material in the bounded domain near the layer is, or behaves like, a linear ortho/anisotropic material. The material properties of the layer should be set to the corresponding properties of this material.
3. The layer should form a cuboid box around the bounded domain, with the axes of the box aligned with the coordinate axes. Various faces of this box may be open, as required by the geometry of the problem, e.g., for a half-space problem, the "top" of the box should be open.
4. Internally, LS-DYNA will partition the entire PML into regions which form the "faces", "edges" and "corners" of the above cuboid box, and generate a new material for each region. This partitioning will be visible in the d3plot file. The user may safely ignore this partitioning.
5. The layer should have 5-10 elements through its depth. Typically, 5-6 elements are sufficient if the excitation source is reasonably distant from the layer, and 8-10 elements if it is close. The size of the elements should be similar to that of elements in the bounded domain near the layer, and should be small enough to sufficiently discretize all significant wavelengths in the problem.
6. The nodes on the outer boundary of the layer should be fully constrained.
7. The stress and strain values reported by this material do not have any physical significance.

***MAT_PML_NULL**

This is Material Type 246. This is a perfectly-matched layer (PML) material with a pressure fluid constitutive law computed using an equation of state, to be used in a wave-absorbing layer adjacent to a fluid material (*MAT_NULL with an EOS) in order to simulate wave propagation in an unbounded fluid medium. Only *EOS_LINEAR_POLYNOMIAL and *EOS_GRUNEISEN are allowed with this material. See the Remarks section of *MAT_NULL (*MAT_009) for further details. Accurate results are to be expected only for the case where the EOS presents a linear relationship between the pressure and volumetric strain.

This material is a variant of MAT_PML_ELASTIC (MAT_230) and is available only for solid 8-node bricks (element type 2).

Card	1	2	3	4	5	6	7	8
Variable	MID	RO	MU					
Type	A8	F	F					
Default	none	none	0.0					

VARIABLE**DESCRIPTION**

MID	Material identification. A unique number or label not exceeding 8 characters must be specified.
RO	Mass density.
MU	Dynamic viscosity coefficient

Remarks:

1. A layer of this material may be placed at a boundary of a bounded domain to simulate unboundedness of the domain at that boundary: the layer absorbs and attenuates waves propagating outward from the domain, without any significant reflection of the waves back into the bounded domain. The layer cannot support any static displacement.
2. It is assumed the material in the bounded domain near the layer is, or behaves like, an linear fluid material. The material properties of the layer should be set to the corresponding properties of this material.
3. The layer should form a cuboid box around the bounded domain, with the axes of the box aligned with the coordinate axes. Various faces of this box may be open, as

required by the geometry of the problem, e.g., for a half-space problem, the “top” of the box should be open.

4. Internally, LS-DYNA will partition the entire PML into regions which form the “faces”, “edges” and “corners” of the above cuboid box, and generate a new material for each region. This partitioning will be visible in the d3plot file. The user may safely ignore this partitioning.
5. The layer should have 5-10 elements through its depth. Typically, 5-6 elements are sufficient if the excitation source is reasonably distant from the layer, and 8-10 elements if it is close. The size of the elements should be similar to that of elements in the bounded domain near the layer, and should be small enough to sufficiently discretize all significant wavelengths in the problem.
6. The nodes on the outer boundary of the layer should be fully constrained.
7. The stress and strain values reported by this material do not have any physical significance.

***MAT_TAILORED_PROPERTIES**

This is Material Type 251. It is similar to MAT_PIECEWISE_LINEAR_PLASTICITY or MAT_024 (see full description there), except for the 3-D table option that uses a history variable (e.g. hardness, temperature, ...) from a previous calculation to evaluate the plastic behavior as a function of 1) history variable, 2) strain rate, and 3) plastic strain. Only available for shell elements.

Card 1	1	2	3	4	5	6	7	8
Variable	MID	R0	E	PR			FAIL	TDEL
Type	A8	F	F	F			F	F
Default	none	none	none	none			10.E+20	0

Card 2	1	2	3	4	5	6	7	8
Variable			LCSS		VP	HISVN	PHASE	
Type			F		F	I	F	
Default			0		0	0	0	

Card 3	1	2	3	4	5	6	7	8
Variable	EPS1	EPS2	EPS3	EPS4	EPS5	EPS6	EPS7	EPS8
Type	F	F	F	F	F	F	F	F
Default	0	0	0	0	0	0	0	0

Card 4	1	2	3	4	5	6	7	8
Variable	ES1	ES2	ES3	ES4	ES5	ES6	ES7	ES8
Type	F	F	F	F	F	F	F	F
Default	0	0	0	0	0	0	0	0

VARIABLE**DESCRIPTION**

MID	Material identification. A unique number or label not exceeding 8 characters must be specified.
RO	Mass density.
E	Young's modulus.
PR	Poisson's ratio.
FAIL	<p>Failure flag.</p> <p>LT.0.0: User defined failure subroutine, matusr_24 in dyn21.F, is called to determine failure</p> <p>EQ.0.0: Failure is not considered. This option is recommended if failure is not of interest since many calculations will be saved.</p> <p>GT.0.0: Effective plastic strain to failure. When the plastic strain reaches this value, the element is deleted from the calculation.</p>
TDEL	Minimum time step size for automatic element deletion.
LCSS	Load curve ID or Table ID (see full description of MAT_024). Load curve for stress vs. plastic strain. 2-D table for stress vs. plastic strain as a function of strain rates. 3-D table for stress vs. plastic strain as a function of strain rates as a function of history variable values (see HISVN).
VP	<p>Formulation for rate effects:</p> <p>EQ.0.0: Scale yield stress (default),</p> <p>EQ.1.0: Viscoplastic formulation.</p>

VARIABLE	DESCRIPTION
HISVN	Location of history variable in the history array of *INITIAL_STRESS_SHELL that is used to evaluate the 3-D table LCSS.
PHASE	Constant value to evaluate the 3-D table LCSS. Only used if HISVN = 0.
EPS1 - EPS8	Effective plastic strain values (optional). At least 2 points should be defined. The first point must be zero corresponding to the initial yield stress.
ES1 - ES8	Corresponding yield stress values to EPS1 - EPS8.

Remarks:

If the 3-D table is used for LCSS, interpolation is used to find the corresponding stress value for the current plastic strain, strain rate, and history variable. In addition, extrapolation is used for the history variable evaluation, which means that some upper and lower “limit curves” have to be used, if extrapolation is not desired.

If material history is written to dynain file using *INTERFACE_SPRINGBACK_LSDYNA, the history variable of material 251 (e.g. hardness, temperature, ...) is written to position HISV6 of *INITIAL_STRESS_SHELL.

It is recommended to set HISVN = 6 and to put the history variable on position HISV6 if *MAT_251 is used in combination with *MAT_ADD_...

***MAT_TOUGHENED_ADHESIVE_POLYMER**

This is Material Type 252, the Toughened Adhesive Polymer model (TAPO). It is based on non-associated $I_1 - J_2$ plasticity constitutive equations and was specifically developed to represent the mechanical behaviour of crash optimized high-strength adhesives under combined shear and tensile loading. This model includes material softening due to damage, rate-dependency, and a constitutive description for the mechanical behaviour of bonded connections under compression.

A detailed description of this material can be found in Burbulla [2013]. This material model can be used with solid elements or with cohesive elements in combination with *MAT_ADD_COHESIVE.

Card 1	1	2	3	4	5	6	7	8
Variable	MID	RO	E	PR	FLG	JCFL	DOPT	
Type	A8	F	F	F	I	I	I	

Card 2	1	2	3	4	5	6	7	8
Variable		TAU0	Q	B	H	C	GAM0	GAMM
Type		F	F	F	F	F	F	F

Card 3	1	2	3	4	5	6	7	8
Variable	A10	A20	A1H	A2H	A2S	POW		
Type	F	F	F	F	F	F		

Card 4	1	2	3	4	5	6	7	8
Variable			D1	D2	D3	D4	D1C	D2C
Type			F	F	F	F	F	F

VARIABLE	DESCRIPTION
MID	Material identification. A unique number or label not exceeding 8 characters must be specified.
RO	Mass density ρ .
E	Young's modulus E .
PR	Poisson's ratio ν .
FLG	Flag to choose between yield functions f and \hat{f} , see Remarks. EQ.0.0: Cap in tension. and <i>Drucker & Prager</i> in compression, EQ.2.0: Cap in tension. and <i>von Mises</i> in compression.
JCFL	Johnson & Cook constitutive failure criterion flag, see Remarks. EQ.0.0: use triaxiality factor only in tension, EQ.1.0: use triaxiality factor in tension and compression.
DOPT	Damage criterion flag \hat{D} or \check{D} , see Remarks. EQ.0.0: damage model uses damage plastic strain r , EQ.1.0: damage model uses plastic arc length γ_v .
TAU0	Initial shear yield stress τ_0 .
Q	Isotropic nonlinear hardening modulus q .
B	Isotropic exponential decay parameter b .
H	Isotropic linear hardening modulus H .
C	Strain rate coefficient C .
GAM0	Quasi-static threshold strain rate γ_0 .
GAMM	Maximum threshold strain rate γ_m .
A10	Yield function parameter: initial value a_{10} of $a_1 = \hat{a}_1(r)$.
A20	Yield function parameter: initial value a_{20} of $a_2 = \hat{a}_2(r)$.
A1H	Yield function parameter a_1^H for formative hardening (ignored if FLG.EQ.2).

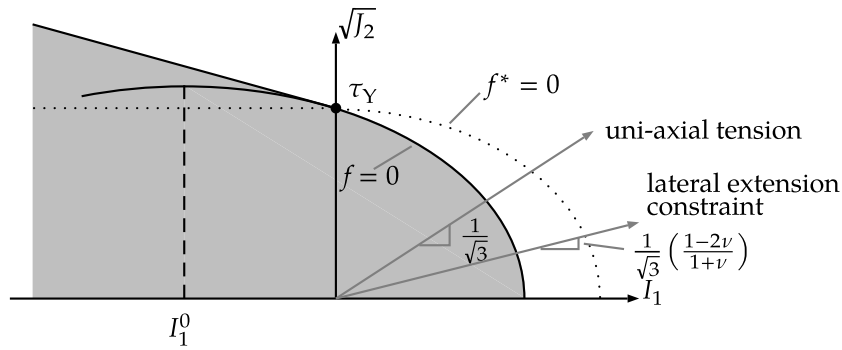

Figure 2-122. Yield function f and plastic flow potential f^*

VARIABLE	DESCRIPTION
A2H	Yield function parameter a_2^H for formative hardening (ignored if FLG.EQ.2).
A2S	Plastic potential parameter a_2^* for hydrostatic stress term.
POW	Exponent n of the phenomenological damage model.
D1	Johnson & Cook failure parameter d_1 .
D2	Johnson & Cook failure parameter d_2 .
D3	Johnson & Cook failure parameter d_3 .
D4	Johnson & Cook rate dependent failure parameter d_4 .
D1C	Johnson & Cook damage threshold parameter d_{1c} .
D2C	Johnson & Cook damage threshold parameter d_{2c} .

Remarks:

Two different I_1 - J_2 yield criteria for isotropic plasticity can be defined by parameter FLG:

1. FLG = 0 is used for the yield criterion f which is changed at the case of hydrostatic pressure $I_1 = 0$ into the *Drucker & Prager* model (DP)

$$f := \frac{J_2}{(1-D)^2} + \frac{1}{\sqrt{3}} a_1 \tau_0 \frac{I_1}{1-D} + \frac{a_2}{3} \left\langle \frac{I_1}{1-D} \right\rangle^2 - \tau_Y^2 = 0$$

with the *Macauley* bracket $\langle \bullet \rangle$, the first invariant of the stress tensor $I_1 = \text{tr } \sigma$, and the second invariant of the stress deviator $J_2 = (1/2)\text{tr}(\mathbf{s})^2$, see [Figure 2-122](#).

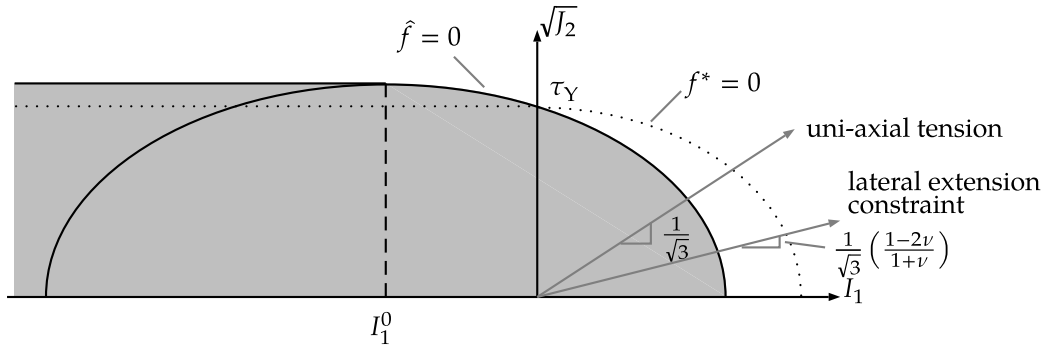

Figure 2-123. Yield function \hat{f} and plastic flow potential f^*

2. FLG = 2 is used for the yield criterion \hat{f} which is changed at the vertex into the deviatoric *von Mises* yield function – see [Figure 2-123](#) – and is used for conservative calculation in case of missing uniaxial compression or combined compression and shear experiments:

$$\hat{f} := \frac{J_2}{(1-D)^2} + \frac{a_2}{3} \left\langle \frac{I_1}{1-D} + \frac{\sqrt{3}a_1\tau_0}{2a_2} \right\rangle^2 - \left(\tau_Y^2 + \frac{a_1^2\tau_0^2}{4a_2} \right) = 0$$

The yield functions f and \hat{f} are formulated in terms of the effective stress tensor $\tilde{\sigma} = \sigma/(1-D)$ and the isotropic material damage D according to the continuum damage mechanics in Lemaitre [1992]. The stress tensor σ is defined in terms of the elastic strain ϵ^e and the isotropic damage D :

$$\sigma = (1-D)\mathbb{C}\epsilon^e$$

The continuity $(1-D)$ in the elastic constitutive equation above degrades the fourth order elastic stiffness tensor \mathbb{C} ,

$$\mathbb{C} = 2G \left(\mathbb{I} - \frac{1}{3}\mathbf{1}\otimes\mathbf{1} \right) + K \mathbf{1}\otimes\mathbf{1}$$

with shear modulus G , bulk modulus K , fourth order identity tensor \mathbb{I} , and second order identity tensor $\mathbf{1}$. The plastic strain rate $\dot{\epsilon}^P$ is given by the non-associated flow rule

$$\dot{\epsilon}^P = \lambda \frac{\partial f^*}{\partial \sigma} = \frac{\lambda}{(1-D)^2} \left(\mathbf{s} + \frac{2}{3}a_2^*\langle I_1 \rangle \mathbf{1} \right)$$

with the potential f^* and an additional parameter $a_2^* < a_2$ to reduce plastic dilatancy.

$$f^* := \frac{J_2}{(1-D)^2} + \frac{a_2^*}{3} \left\langle \frac{I_1}{1-D} \right\rangle^2 - \tau_Y^2$$

The plastic arc length $\dot{\gamma}_v$ characterizes the inelastic response of the material and is defined by the Euclidean norm:

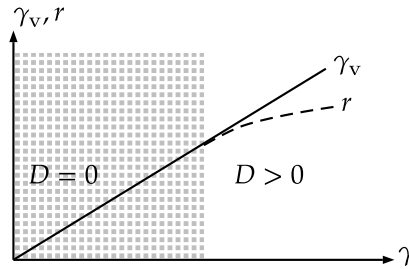

Figure 2-124. Accumulated plastic strain γ_v and damage plastic strain r versus strain γ

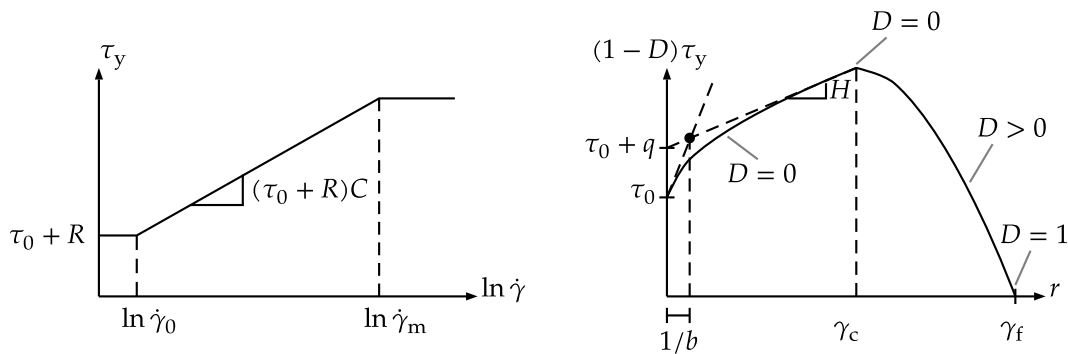

Figure 2-125. Rate-dependent tensile strength τ_Y versus effective strain rate $\dot{\gamma}$ (left) and effective damage plastic strain r (right)

$$\dot{\gamma}_v := \sqrt{2 \operatorname{tr}(\dot{\epsilon}^P)^2} = \frac{2\lambda}{(1-D)^2} \sqrt{J_2 + \frac{2}{3} (a_2^* \langle I_1 \rangle)^2}$$

In addition, the arc length of the damage plastic strain rate \dot{r} is introduced by means of the arc length $\dot{\gamma}_v$ and the continuity $(1-D)$ as in Lemaitre [1992], where $\tilde{I}_1 = I_1/(1-D)$ and $\tilde{J}_2 = J_2/(1-D)^2$ are the effective stress invariants, see [Figure 2-124](#).

$$\dot{r} := (1-D)\dot{\gamma}_v = 2\lambda \sqrt{\tilde{J}_2 + \frac{2}{3} (a_2^* \langle \tilde{I}_1 \rangle)^2}$$

The rate-dependent yield strength for shear τ_Y can be defined by two alternative expressions. The first representation is an analytic expression for τ_Y :

$$\tau_Y = (\tau_0 + R) \left[1 + C \left(\left\langle \ln \frac{\dot{\gamma}}{\dot{\gamma}_0} \right\rangle - \left\langle \ln \frac{\dot{\gamma}}{\dot{\gamma}_m} \right\rangle \right) \right], \text{ with } \dot{\gamma} = \sqrt{2 \operatorname{tr}(\dot{\epsilon})^2}$$

where the first factor $(\tau_0 + R)$ in τ_Y is given by the static yield strength with the initial yield τ_0 and the non-linear hardening contribution

$$R = q[1 - \exp(-br)] + Hr$$

The second factor [...] in τ_Y describes the rate dependency of the yield strength by a modified Johnson & Cook approach with the reference strain rates $\dot{\gamma}_0$ and $\dot{\gamma}_m$ which limit the shear strength τ_Y , see [Figure 2-125](#).

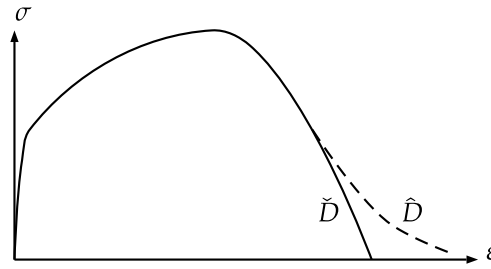

Figure 2-126. Influence of DOPT on damage softening

Toughened structural adhesives show distortional hardening under plastic flow, i.e. the yield surface changes its shape. This formative hardening can be phenomenological described by simple evolution equations of parameters $a_1 = \hat{a}_1(r) \wedge a_2 = \hat{a}_2(r)$ in the yield criterions f with the initial values a_{10} and a_{20} :

$$a_1 = \hat{a}_1(r) \wedge \dot{a}_1 = a_1^H \dot{r}$$

$$a_2 = \hat{a}_2(r) \wedge a_2 \geq 0 \wedge \dot{a}_2 = a_2^H \dot{r}$$

The parameters a_1^H and a_2^H can take positive or negative values as long as the inequality $a_2 \geq 0$ is satisfied. The criterion $a_2 \geq 0$ ensures an elliptic yield surface. The yield criterion \hat{f} uses only the initial values $a_1 = a_{10}$ and $a_2 = a_{20}$ without the distortional hardening.

The empirical isotropic damage model D is based on the approach in Lemaitre [1985]. Two different evolution equations $\hat{D}(r, \dot{r})$ and $\check{D}(\gamma_v, \dot{\gamma}_v)$ are available, [Figure 2-126](#) see. The damage variable D is formulated in terms of the damage plastic strain rate \dot{r} (DOPT = 0)

$$\dot{D} = \hat{D}(r, \dot{r}) = n \left\langle \frac{r - \gamma_c}{\gamma_f - \gamma_c} \right\rangle^{n-1} \frac{\dot{r}}{\gamma_f - \gamma_c}$$

or of the plastic arc length $\dot{\gamma}_v$ (DOPT = 1)

$$\dot{D} = \check{D}(\gamma_v, \dot{\gamma}_v) = n \left\langle \frac{\gamma_v - \gamma_c}{\gamma_f - \gamma_c} \right\rangle^{n-1} \frac{\dot{\gamma}_v}{\gamma_f - \gamma_c}$$

where r in contrast to γ_v increases non-proportionally slowly, see [Figure 2-126](#). The strains at the thresholds γ_c and γ_f for damage initiation and rupture are functions of the triaxiality $T = \sigma_m / \sigma_{eq}$ with the hydrostatic stress $\sigma_m = I_1 / 3$ and the von Mises equivalent stress $\sigma_{eq} = \sqrt{3J_2}$ as in Johnson and Cook [1985].

$$\gamma_c = [d_{1c} + d_{2c} \exp(-d_3 \langle T \rangle)] \left(1 + d_4 \left\langle \ln \frac{\dot{\gamma}}{\dot{\gamma}_0} \right\rangle \right)$$

$$\gamma_f = [d_1 + d_2 \exp(-d_3 \langle T \rangle)] \left(1 + d_4 \left\langle \ln \frac{\dot{\gamma}}{\dot{\gamma}_0} \right\rangle \right)$$

The option JCFL controls the influence of triaxiality $T = \sigma_m / \sigma_{eq}$ in the pressure range for the thresholds γ_c and γ_f . JCFL = 0 makes use of the Macauley bracket $\langle T \rangle$ for the triaxiality $T = \sigma_m / \sigma_{eq}$ and JCFL = 1 omits the Macauley bracket $\langle T \rangle$.

History Variables:

VARIABLE	DESCRIPTION
1	damage variable D
2	plastic arc length γ_v
3	damage plastic arc length r

***MAT_PIECEWISE_LINEAR_PLASTIC_THERMAL**

This is material type 255, an isotropic elastoplastic material with thermal properties. It can be used for both explicit and implicit analyses. Young’s modulus and Poisson’s ratio can depend on the temperature by defining two load curves. Moreover, the yield stress in tension and compression are given as load curves for different temperatures by using two tables. The thermal coefficient of expansion can be given as a constant ALPHA or as a load curve, see LALPHA at position 3 on card 2. A positive curve ID for LALPHA models the instantaneous thermal coefficient, whereas a negatives curve ID models the thermal coefficient relative to a reference temperature, TREF. The strain rate effects are modelled with the Cowper-Symonds rate model with the parameters C and P on card 1. Failure can be based on effective plastic strain or using the *MAT_ADD_EROSION keyword.

Card 1	1	2	3	4	5	6	7	8
Variable	MID	RO	E	PR	C	P	FAIL	TDEL
Type	A8	F	F	F	F	F	F	F

Card 2	1	2	3	4	5	6	7	8
Variable	TABIDC	TABIDT	LALPHA					
Type	I	I	I					

Card 3	1	2	3	4	5	6	7	8
Variable	ALPHA	TREF						
Type	F	F						

VARIABLE

DESCRIPTION

- MID Material identification. A unique number or label not exceeding 8 characters must be specified.
- RO Mass density.

VARIABLE	DESCRIPTION
E	Young's modulus: LT.0.0: E is the LCID for E versus temperature, GT.0.0: E is constant.
PR	Poisson's ratio. LT.0.0: PR is the LCID for Poisson's ratio versus temperature. GT.0.0: PR is constant
C	Strain rate parameter. See remark 1.
P	Strain rate parameter. See remark 1.
FAIL	Effective plastic strain when the material fails. User defined failure subroutine, matusr_24 in dyn21.F, is called to determine failure when FAIL < 0. Note that for solids the *MAT_ADD_EROSION can be used for additional failure criteria.
TDEL	A time step less then TDEL is not allowed. A step size less than TDEL trigger automatic element deletion. This option is ignored for implicit analyses.
TABIDC	Table ID for yield stress in compression, see remark 2.
TABIDT	Table ID for yield stress in tension, see remark 2.
LALPHA	Load curve ID for thermal expansion coefficient as a function of temperature. GT.0.0: the instantaneous thermal expansion coefficient based on the following formula: $d\varepsilon_{ij}^{\text{thermal}} = \alpha(T)dT\delta_{ij}$ LT.0.0: the thermal coefficient is defined relative a reference temperature TREF, such that the total thermal strain is given by: $\varepsilon_{ij}^{\text{thermal}} = \alpha(T)(T - T_{\text{ref}})\delta_{ij}$ With this option active, ALPHA is ignored.
ALPHA	Coefficient of thermal expansion

VARIABLE	DESCRIPTION
TREF	Reference temperature, which is required if and only if LALPHA is given with a negative load curve ID.

Remarks:

1. The strain rate effect is modelled by using the Cowper and Symonds model which scales the yield stress according to the factor

$$1 + \left(\frac{\dot{\epsilon}}{C}\right)^{1/P}$$

where $\dot{\epsilon} = \sqrt{\dot{\epsilon}_{ij}\dot{\epsilon}_{ij}}$ is the Euclidean norm of the total strain rate tensor.

2. The yield stresses versus effective plastic strains are given in two tables. One table for yield stresses in compression and another table for yield stresses in tension. The table indices consist of temperatures and at each temperature an unique yield stress curve must be defined. Both TABIDC and TABIDT could be 3D tables, in which temperatures are input as main table values and strain rates are defined as values for the sub tables, and hardening curves as targets for those strain rates. If the same yield stress should be used in both tension and compression, only one table needs to be defined and the same TABID is put in position 1 and 2 on card 2.
3. Two history variables are added to the d3plot file, the Young's modulus and the Poisson's ratio, respectively. They can be requested through the *DATABASE_EXTENT_BINARY keyword.
4. Nodal temperatures must be defined by using a coupled analysis or some other way to define the temperatures, such as *LOAD_THERMAL_VARIABLE or *LOAD_THERMAL_LOAD_CURVE.

***MAT_AMORPHOUS_SOLIDS_FINITE_STRAIN**

This is material type 256, an isotropic elastic-viscoplastic material model intended to describe the behaviour of amorphous solids such as polymeric glasses. The model accurately captures the hardening-softening-hardening sequence and the Bauschinger effect experimentally observed at tensile loading and unloading respectively. The formulation is based on hyperelasticity and uses the multiplicative split of the deformation gradient F which makes it naturally suitable for both large rotations and large strains. Stress computations are performed in an intermediate configuration and are therefore preceded by a pull-back and followed by a push-forward. The model was originally developed by Anand and Gurtin [2003] and implemented for solid elements by Bonnaud and Faleskog [2008]

Card 1	1	2	3	4	5	6	7	8
Variable	MID	RO	K	G	MR	LL	NU0	M
Type	A8	F	F	F	F	F	F	F

Card 2	1	2	3	4	5	6	7	8
Variable	ALPHA	H0	SCV	B	ECV	G0	S0	
Type	F	F	F	F	F	F	F	

VARIABLE**DESCRIPTION**

MID	Material identification. A unique number or label not exceeding 8 characters must be specified.
RO	Mass density
K	Bulk modulus
G	Shear modulus
MR	Kinematic hardening parameter: μ_R (see Eq.1)
LL	Kinematic hardening parameter: λ_L (see Eq.1)
NU0	Creep parameter: v_0 (see Eq.2)
M	Creep parameter: m (see Eq.2)

VARIABLE	DESCRIPTION
ALPHA	Creep parameter: α (see Eq.2)
H0	Isotropic hardening parameter: h_0 (see Eq.3-5)
SCV	Isotropic hardening parameter: s_{cv} (see Eq.3-5)
B	Isotropic hardening parameter: b (see Eq.3-5)
ECV	Isotropic hardening parameter: η_{cv} (see Eq.3-5)
G0	Isotropic hardening parameter: g_0 (see Eq.3-5)
S0	Isotropic hardening parameter: s_0 (see Eq.3-5)

Remarks:

1. Kinematic hardening gives rise to the second hardening occurrence in the hardening-softening-hardening sequence. The constants μ_R and λ_L enter the back stress μB (where B is the left Cauchy-Green deformation tensor) through the function μ according to:

$$\mu = \mu_r \left(\frac{\lambda_L}{3\lambda^p} \right) L^{-1} \left(\frac{\lambda^p}{\lambda_L} \right) \quad (256.1)$$

Where $\lambda^p = \frac{1}{\sqrt{3}} \sqrt{\text{tr}(B^p)}$ and B^p is the plastic part of the left Cauchy-Green deformation tensor and where L is the Langevin function defined by,

$$L(X) = \coth(X) - X^{-1}$$

2. This material model assumes plastic incompressibility. Nevertheless in order to account for the different behaviours in tension and compression a Drucker-Prager law is included in the creep law according to:

$$\nu^p = \nu_0 \left(\frac{\bar{\tau}}{s + \alpha\pi} \right)^{1/m} \quad (256.2)$$

Where ν^p is the equivalent plastic shear strain rate, $\bar{\tau}$ the equivalent shear stress, s the internal variable defined below and $-\pi$ the hydrostatic stress.

3. Isotropic hardening gives rise to the first hardening occurrence in the hardening-softening-hardening sequence. Two coupled internal variables are defined: s the resistance to plastic flow and η the local free volume. Their evolution equations read:

$$\dot{s} = h_0 \left[1 - \frac{s}{\tilde{s}(\eta)} \right] v^p \tag{256.3}$$

$$\dot{\eta} = g_0 \left(\frac{s}{s_{cv}} - 1 \right) v^p \tag{256.4}$$

$$\tilde{s}(\eta) = s_{cv} [1 + b(\eta_{cv} - \eta)] \tag{256.5}$$

4. Typical material parameters values are given in Ref.1 for Polycarbonate:

PolyC 1	1	2	3	4	5	6	7	8
Variable	MID	RO	K	G	MR	LL	NU0	M
Value			2.24GPa	0.857GPa	11.0MPa	1.45	0.0017s ⁻¹	0.011

PolyC 2	1	2	3	4	5	6	7	8
Variable	ALPHA	H0	SCV	B	ECV	G0	S0	
Value	0.08	2.75GPa	24.0MPa	825	0.001	0.006	20.0MPa	

[1] Anand, L., Gurtin, M.E., 2003, "A theory of amorphous solids undergoing large deformations, with application to polymeric glasses," *International Journal of Solids and Structures*, 40, pp. 1465-1487.

***MAT_LAMINATED_FRACTURE_DAIMLER_PINHO**

This is Material Type 261 which is an orthotropic continuum damage model for laminated fiber-reinforced composites. See Pinho, Iannucci and Robinson [2006]. It is based on a physical model for each failure mode and considers non-linear in-plane shear behavior.

This model is implemented for shell, thick shell and solid elements.

Remark: Laminated shell theory can be applied by setting LAMSHT ≥ 3 in *CONTROL_-SHELL.

Card 1	1	2	3	4	5	6	7	8
Variable	MID	RO	EA	EB	EC	PRBA	PRCA	PRCB
Type	A8	F	F	F	F	F	F	F

Card 2	1	2	3	4	5	6	7	8
Variable	GAB	GBC	GCA	AOPT	DAF	DKF	DMF	EFS
Type	F	F	F	F	F	F	F	F

Card 3	1	2	3	4	5	6	7	8
Variable	XP	YP	ZP	A1	A2	A3		
Type	F	F	F	F	F	F		

Card 4	1	2	3	4	5	6	7	8
Variable	V1	V2	V3	D1	D2	D3	MANGLE	
Type	F	F	F	F	F	F	F	

Card 5	1	2	3	4	5	6	7	8
Variable	ENKINK	ENA	ENB	ENT	ENL			
Type	F	F	F	F	F			

Card 6	1	2	3	4	5	6	7	8
Variable	XC	XT	YC	YT	SL			
Type	F	F	F	F	F			

Card 7	1	2	3	4	5	6	7	8
Variable	FIO	SIGY	LCSS	BETA	PFL	PUCK	SOFT	
Type	F	F	F	F	F	F	F	

VARIABLE**DESCRIPTION**

MID	Material identification. A unique number or label not exceeding 8 characters must be specified.
RO	Mass density
EA	E_a , Young's modulus in a-direction (longitudinal)
EB	E_b , Young's modulus in b-direction (transverse)
EC	E_c , Young's modulus in c-direction
PRBA	ν_{ba} , Poisson's ratio ba
PRCA	ν_{ca} , Poisson's ratio ca
PRCB	ν_{cb} , Poisson's ratio cb
GAB	G_{ab} , shear modulus ab
GBC	G_{bc} , shear modulus bc

VARIABLE	DESCRIPTION
GCA	G_{ca} , shear modulus ca
AOPT	<p>Material axes option (see MAT_OPTION TROPIC_ELASTIC for a more complete description):</p> <p>EQ.0.0: locally orthotropic with material axes determined by element nodes 1, 2, and 4, as with *DEFINE_COORDINATE_NODES, and then, for shells only, rotated about the shell element normal by an angle MANGLE.</p> <p>EQ.1.0: locally orthotropic with material axes determined by a point in space and the global location of the element center; this is the a-direction. This option is for solid elements only.</p> <p>EQ.2.0: globally orthotropic with material axes determined by vectors defined below, as with *DEFINE_COORDINATE_VECTOR.</p> <p>EQ.3.0: locally orthotropic material axes determined by rotating the material axes about the element normal by an angle (MANGLE) from a line in the plane of the element defined by the cross product of the vector v with the element normal.</p> <p>EQ.4.0: locally orthotropic in cylindrical coordinate system with the material axes determined by a vector v, and an originating point, p, which define the centerline axis. This option is for solid elements only.</p> <p>LT.0.0: the absolute value of AOPT is a coordinate system ID number (CID on *DEFINE_COORDINATE_NODES, *DEFINE_COORDINATE_SYSTEM or *DEFINE_COORDINATE_VECTOR). Available in R3 version of 971 and later.</p>
DAF	<p>Flag to control failure of an integration point based on longitudinal (fiber) tensile failure:</p> <p>EQ.0.0: IP fails if any damage variable reaches 1.0.</p> <p>EQ.1.0: no failure of IP due to fiber tensile failure (da(i)=1.0)</p>

VARIABLE	DESCRIPTION
DKF	Flag to control failure of an integration point based on longitudinal (fiber) compressive failure: EQ.0.0: IP fails if any damage variable reaches 1.0. EQ.1.0: no failure of IP due to fiber compressive failure (dkink(i)=1.0)
DMF	Flag to control failure of an integration point based on transverse (matrix) failure: EQ.0.0: IP fails if any damage variable reaches 1.0. EQ.1.0: no failure of IP due to matrix failure (dmat(i)=1.0)
EFS	Maximum effective strain for element layer failure. A value of unity would equal 100% strain. GT.0.0: fails when effective strain calculated assuming material is vol-ume preserving exceeds EFS. LT.0.0: fails when effective strain calculated from the full strain tensor exceeds EFS .
XP, YP, ZP	Coordinates of point p for AOPT = 1 and 4.
A1, A2, A3	Define components of vector a for AOPT = 2.
V1, V2, V3	Define components of vector v for AOPT = 3.
D1, D2, D3	Define components of vector d for AOPT = 2.
MANGLE	Material angle in degrees for AOPT = 0 (shells only) and 3. MANGLE may be overridden on the element card, see *ELEMENT_SHELL_BETA and *ELEMENT_SOLID_ORTHO.
ENKINK	Fracture toughness for longitudinal (fiber) compressive failure mode. GT.0.0: The given value will be regularized with the characteristic element length. LT.0.0: Load curve ID=(-ENKINK) which defines the fracture toughness for fiber compressive failure mode as a function of characteristic element length. No further regularization.

VARIABLE	DESCRIPTION
ENA	Fracture toughness for longitudinal (fiber) tensile failure mode. GT.0.0: The given value will be regularized with the characteristic element length. LT.0.0: Load curve ID=(-ENA) which defines the fracture toughness for fiber tensile failure mode as a function of characteristic element length. No further regularization.
ENB	Fracture toughness for intralaminar matrix tensile failure. GT.0.0: The given value will be regularized with the characteristic element length. LT.0.0: Load curve ID=(-ENB) which defines the fracture toughness for intralaminar matrix tensile failure as a function of characteristic element length. No further regularization.
ENT	Fracture toughness for intralaminar matrix transverse shear failure. GT.0.0: The given value will be regularized with the characteristic element length. LT.0.0: Load curve ID=(-ENT) which defines the fracture toughness for intralaminar matrix transverse shear failure as a function of characteristic element length. No further regularization.
ENL	Fracture toughness for intralaminar matrix longitudinal shear failure. GT.0.0: The given value will be regularized with the characteristic element length. LT.0.0: Load curve ID=(-ENL) which defines the fracture toughness for intralaminar matrix longitudinal shear failure as a function of characteristic element length. No further regularization.
XC	Longitudinal compressive strength, a-axis (positive value).
XT	Longitudinal tensile strength, a-axis.
YC	Transverse compressive strength, b-axis (positive value).
YT	Transverse tensile strength, b-axis.

VARIABLE	DESCRIPTION
SL	Longitudinal shear strength.
FIO	Fracture angle in pure transverse compression (in degrees, default = 53.0).
SIGY	In-plane shear yield stress.
LCSS	Load curve ID which defines the non-linear in-plane shear-stress as a function of in-plane shear-strain.
BETA	Hardening parameter for in-plane shear plasticity ($0.0 \leq \text{BETA} \leq 1.0$). EQ.0.0: Pure kinematic hardening EQ.1.0: Pure isotropic hardening $0.0 < \text{BETA} < 1.0$: mixed hardening.
PFL	Percentage of layers which must fail until crashfront is initiated. E.g. $ \text{PFL} = 80.0$, then 80 % of layers must fail until strengths are reduced in neighboring elements. Default: all layers must fail. A single layer fails if 1 in-plane IP fails ($\text{PFL} > 0$) or if 4 in-plane IPs fail ($\text{PFL} < 0$).
PUCK	Flag for evaluation and post-processing of Puck's inter-fiber-failure criterion (IFF, see Puck, Kopp and Knops [2002]). EQ.0.0: no evaluation of Puck's IFF-criterion. EQ.1.0: Puck's IFF-criterion will be evaluated.
SOFT	Softening reduction factor for material strength in crashfront elements (default = 1.0).

Remarks:

The failure surface to limit the elastic domain is assembled by four sub-surfaces, representing different failure mechanisms. They are defined as follows:

longitudinal (fiber) tension,

$$f_a = \frac{\sigma_a}{X_T} = 1$$

longitudinal (fiber) compression (3D-kinking model) – (transformation to fracture plane),

$$f_{kink} = \begin{cases} \left(\frac{\tau_T}{S_T - \mu_T \sigma_n} \right)^2 + \left(\frac{\tau_L}{S_L - \mu_L \sigma_n} \right)^2 = 1 & \text{if } \sigma_{b^m} \leq 0 \\ \left(\frac{\sigma_n}{Y_T} \right)^2 + \left(\frac{\tau_T}{S_T} \right)^2 + \left(\frac{\tau_L}{S_L} \right)^2 = 1 & \text{if } \sigma_{b^m} > 0 \end{cases}$$

with

$$S_T = \frac{Y_C}{2 \tan(\phi_0)} ; \quad \mu_T = -\frac{1}{\tan(2\phi_0)} ; \quad \mu_L = S_L \frac{\mu_T}{S_T}$$

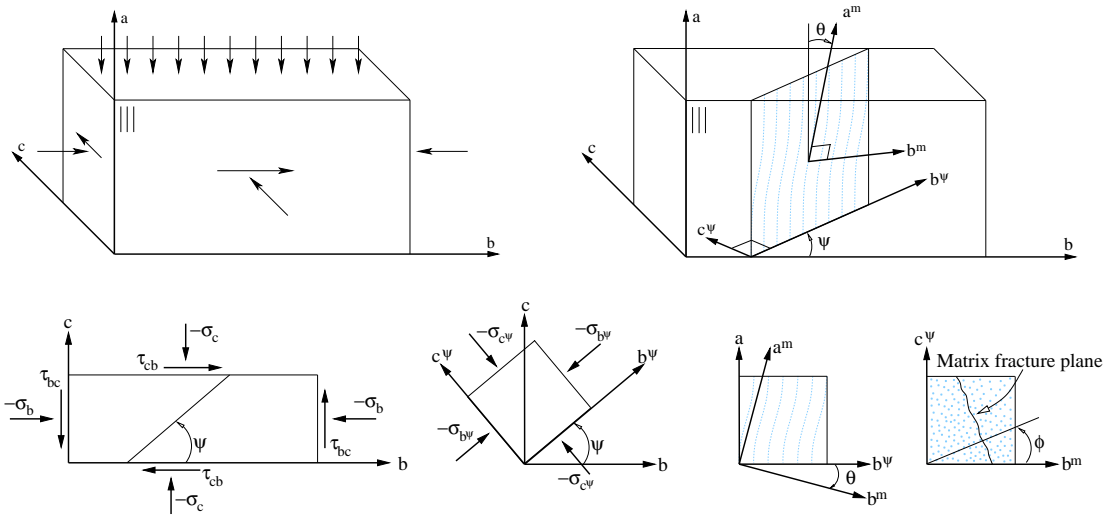

$$\begin{aligned} \sigma_n &= \frac{\sigma_{b^m} + \sigma_{c^psi}}{2} + \frac{\sigma_{b^m} - \sigma_{c^psi}}{2} \cos(2\phi) + \tau_{b^m c^psi} \sin(2\phi) \\ \tau_T &= -\frac{\sigma_{b^m} - \sigma_{c^psi}}{2} \sin(2\phi) + \tau_{b^m c^psi} \cos(2\phi) \\ \tau_L &= \tau_{a^m b^m} \cos(\phi) + \tau_{c^psi a^m} \sin(\phi) \end{aligned}$$

transverse (matrix) failure: transverse tension,

$$f_{mat} = \left(\frac{\sigma_n}{Y_T} \right)^2 + \left(\frac{\tau_T}{S_T} \right)^2 + \left(\frac{\tau_L}{S_L} \right)^2 = 1 \quad \text{if } \sigma_n \geq 0$$

with

$$\begin{aligned} \sigma_n &= \frac{\sigma_b + \sigma_c}{2} + \frac{\sigma_b - \sigma_c}{2} \cos(2\phi) + \tau_{bc} \sin(2\phi) \\ \tau_T &= -\frac{\sigma_b - \sigma_c}{2} \sin(2\phi) + \tau_{bc} \cos(2\phi) \\ \tau_L &= \tau_{ab} \cos(\phi) + \tau_{ca} \sin(\phi) \end{aligned}$$

transverse (matrix) failure: transverse compression/shear,

$$f_{mat} = \left(\frac{\tau_T}{S_T - \mu_T \sigma_n} \right)^2 + \left(\frac{\tau_L}{S_L - \mu_L \sigma_n} \right)^2 = 1 \quad \text{if } \sigma_n < 0$$

As long as the stress state is located within the failure surface the model behaves orthotropic elastic. When reaching the failure criteria the effective (undamaged) stresses will be reduced by a factor of $(1-d)$, where the damage variable d represents one of the damage variables defined for the different failure mechanisms (d_a, d_{kink}, d_{mat}). The growth of these damage variables is driven by a linear damage evolution law based on fracture toughnesses ($\Gamma \rightarrow$ ENKINK, ENA, ENB, ENT, ENL) and a characteristic internal element length (L) to account for objectivity.

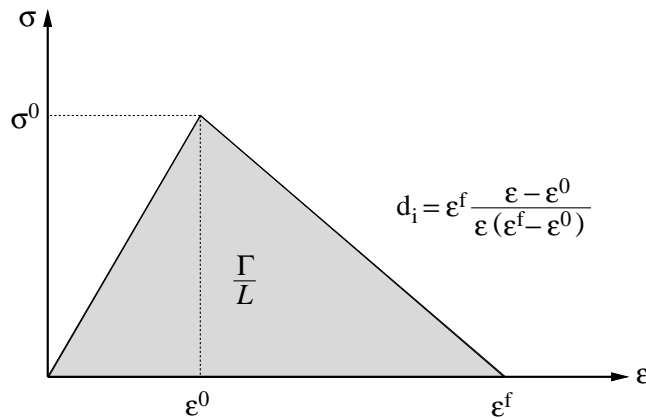

To account for the characteristic non-linear in-plane shear behavior of laminated fiber-reinforced composites a 1D elasto-plastic formulation is coupled to a linear damage behavior once the maximum allowable stress state for shear failure is reached. The non-linearity of the shear behavior can be introduced via the definition of an explicit shear stress vs. shear strain curve (LCSS) with *DEFINE_CURVE.

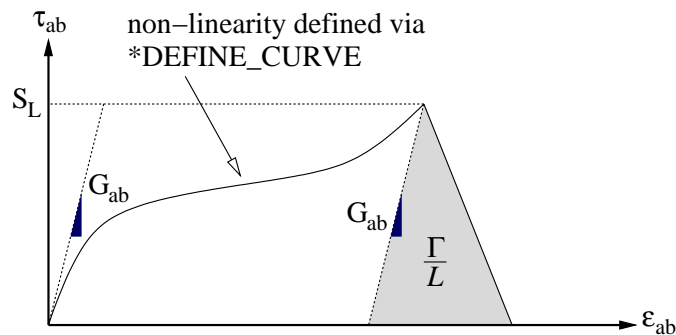

More detailed information about this material model can be found in Pinho, Iannucci and Robinson [2006].

When failure has occurred in all the composite layers (through-thickness integration points), the element is deleted. Elements which share nodes with the deleted element become “crashfront” elements and can have their strengths reduced by using the SOFT parameter. An earlier initiation of crashfront elements is possible by using the parameter PFL.

The number of additional integration point variables written to the LS-DYNA database is input by the *DATABASE_EXTENT_BINARY definition with the variable NEIPS (shells) and NEIPH (solids). These additional variables are tabulated below (*i* = integration point):

History Variable	Description	Value	LS-PrePost history variable
fa(i)	fiber tensile mode	0→1: elastic 1: failure criterion reached	1
fkink(i)	fiber compressive mode		2
fmat(i)	matrix mode		3
da(i)	damage fiber tension	0: elastic 1: fully damaged	5
dkink(i)	damage fiber compression		6
dmat(i)	damage transverse		7
dam(i)	crashfront	-1: element intact 10-8: element in crashfront +1: element failed	9
fmt_p(i)	tensile matrix mod (Puck criteria)	0→1: elastic 1: failure criterion reached	10
fmc_p(i)	compressive matrix mode (Puck criteria)		11
theta_p(i)	angle of fracture plane (radians, Puck criteria)		12

MAT_262**MAT_LAMINATED_FRACTURE_DAIMLER_CAMANHO*****MAT_LAMINATED_FRACTURE_DAIMLER_CAMANHO**

This is Material Type 262 which is an orthotropic continuum damage model for laminated fiber-reinforced composites. See Maimí, Camanho, Mayugo and Dávila [2007]. It is based on a physical model for each failure mode and considers a simplified non-linear in-plane shear behavior.

This model is implemented for shell, thick shell and solid elements.

Remark: Laminated shell theory can be applied by setting $LAMSHT \geq 3$ in *CONTROL_-SHELL.

Card 1	1	2	3	4	5	6	7	8
Variable	MID	R0	EA	EB	EC	PRBA	PRCA	PRCB
Type	A8	F	F	F	F	F	F	F

Card 2	1	2	3	4	5	6	7	8
Variable	GAB	GBC	GCA	AOPT	DAF	DKF	DMF	EFS
Type	F	F	F	F	F	F	F	F

Card 3	1	2	3	4	5	6	7	8
Variable	XP	YP	ZP	A1	A2	A3		
Type	F	F	F	F	F	F		

Card 4	1	2	3	4	5	6	7	8
Variable	V1	V2	V3	D1	D2	D3	MANGLE	
Type	F	F	F	F	F	F	F	

Card 5	1	2	3	4	5	6	7	8
Variable	GXC	GXT	GYC	GYT	GSL	GXCO	GXT0	
Type	F	F	F	F	F	F	F	

Card 6	1	2	3	4	5	6	7	8
Variable	XC	XT	YC	YT	SL	XCO	XT0	
Type	F	F	F	F	F	F	F	

Card 7	1	2	3	4	5	6	7	8
Variable	FIO	SIGY	ETAN	BETA	PFL	PUCK	SOFT	
Type	F	F	F	F	F	F	F	

VARIABLE

DESCRIPTION

- MID Material identification. A unique number or label not exceeding 8 characters must be specified.
- RO Mass density
- EA E_a , Young's modulus in a-direction (longitudinal)
- EB E_b , Young's modulus in b-direction (transverse)
- EC E_c , Young's modulus in c-direction
- PRBA ν_{ba} , Poisson's ratio ba
- PRCA ν_{ca} , Poisson's ratio ca
- PRCB ν_{cb} , Poisson's ratio cb
- GAB G_{ab} , shear modulus ab
- GBC G_{bc} , shear modulus bc

VARIABLE	DESCRIPTION
GCA	G_{ca} , shear modulus ca
AOPT	<p>Material axes option (see <i>MAT_OPTION TROPIC_ELASTIC</i> for a more complete description):</p> <p>EQ.0.0: locally orthotropic with material axes determined by element nodes 1, 2, and 4, as with <i>*DEFINE_COORDINATE_NODES</i>, and then, for shells only, rotated about the shell element normal by an angle <i>MANGLE</i>.</p> <p>EQ.1.0: locally orthotropic with material axes determined by a point in space and the global location of the element center; this is the a-direction. This option is for solid elements only.</p> <p>EQ.2.0: globally orthotropic with material axes determined by vectors defined below, as with <i>*DEFINE_COORDINATE_VECTOR</i>.</p> <p>EQ.3.0: locally orthotropic material axes determined by rotating the material axes about the element normal by an angle (<i>MANGLE</i>) from a line in the plane of the element defined by the cross product of the vector <i>v</i> with the element normal.</p> <p>EQ.4.0: locally orthotropic in cylindrical coordinate system with the material axes determined by a vector <i>v</i>, and an originating point, <i>p</i>, which define the centerline axis. This option is for solid elements only.</p> <p>LT.0.0: the absolute value of <i>AOPT</i> is a coordinate system ID number (<i>CID</i> on <i>*DEFINE_COORDINATE_NODES</i>, <i>*DEFINE_COORDINATE_SYSTEM</i> or <i>*DEFINE_COORDINATE_VECTOR</i>). Available in R3 version of 971 and later.</p>
DAF	<p>Flag to control failure of an integration point based on longitudinal (fiber) tensile failure:</p> <p>EQ.0.0: IP fails if any damage variable reaches 1.0.</p> <p>EQ.1.0: no failure of IP due to fiber tensile failure ($da(i)=1.0$)</p>

VARIABLE	DESCRIPTION
DKF	Flag to control failure of an integration point based on longitudinal (fiber) compressive failure: EQ.0.0: IP fails if any damage variable reaches 1.0. EQ.1.0: no failure of IP due to fiber compressive failure (dkink(i)=1.0)
DMF	Flag to control failure of an integration point based on transverse (matrix) failure: EQ.0.0: IP fails if any damage variable reaches 1.0. EQ.1.0: no failure of IP due to matrix failure (dmat(i)=1.0)
EFS	Maximum effective strain for element layer failure. A value of unity would equal 100% strain. GT.0.0: fails when effective strain calculated assuming material is vol-ume preserving exceeds EFS. LT.0.0: fails when effective strain calculated from the full strain tensor exceeds EFS .
XP YP ZP	Coordinates of point p for AOPT = 1 and 4.
A1 A2 A3	Define components of vector a for AOPT = 2.
V1 V2 V3	Define components of vector v for AOPT = 3.
D1 D2 D3	Define components of vector d for AOPT = 2.
MANGLE	Material angle in degrees for AOPT = 0 (shells only) and 3. MANGLE may be overridden on the element card, see *ELEMENT_SHELL_BETA and *ELEMENT_SOLID_ORTHO.
GXC	Fracture toughness for longitudinal (fiber) compressive failure mode. GT.0.0: The given value will be regularized with the characteristic element length. LT.0.0: Load curve ID=(-GXC) which defines the fracture toughness for fiber compressive failure mode as a function of characteristic element length. No further regularization.

VARIABLE	DESCRIPTION
GXT	<p>Fracture toughness for longitudinal (fiber) tensile failure mode.</p> <p>GT.0.0: The given value will be regularized with the characteristic element length.</p> <p>LT.0.0: Load curve ID=(-GXT) which defines the fracture toughness for fiber tensile failure mode as a function of characteristic element length. No further regularization.</p>
GYC	<p>Fracture toughness for transverse compressive failure mode.</p> <p>GT.0.0: The given value will be regularized with the characteristic element length.</p> <p>LT.0.0: Load curve ID=(-GYC) which defines the fracture toughness for transverse compressive failure mode as a function of characteristic element length. No further regularization.</p>
GYT	<p>Fracture toughness for transverse tensile failure mode.</p> <p>GT.0.0: The given value will be regularized with the characteristic element length.</p> <p>LT.0.0: Load curve ID=(-GYT) which defines the fracture toughness for transverse tensile failure mode as a function of characteristic element length. No further regularization.</p>
GSL	<p>Fracture toughness for in-plane shear failure mode.</p> <p>GT.0.0: The given value will be regularized with the characteristic element length.</p> <p>LT.0.0: Load curve ID=(-GSL) which defines the fracture toughness for in-plane shear failure mode as a function of characteristic element length. No further regularization.</p>
GXCO	<p>Fracture toughness for longitudinal (fiber) compressive failure mode to define bi-linear damage evolution.</p> <p>GT.0.0: The given value will be regularized with the characteristic element length.</p> <p>LT.0.0: Load curve ID=(-GXCO) which defines the fracture toughness for fiber compressive failure mode to define bi-linear damage evolution as a function of characteristic element length. No further regularization.</p>

VARIABLE	DESCRIPTION
GXTO	<p>Fracture toughness for longitudinal (fiber) tensile failure mode to define bi-linear damage evolution.</p> <p>GT.0.0: The given value will be regularized with the characteristic element length.</p> <p>LT.0.0: Load curve ID=(-GXTO) which defines the fracture toughness for fiber tensile failure mode to define bi-linear damage evolution as a function of characteristic element length. No further regularization.</p>
XC	Longitudinal compressive strength, a-axis (positive value).
XT	Longitudinal tensile strength, a-axis.
YC	Transverse compressive strength, b-axis (positive value).
YT	Transverse tensile strength, b-axis.
SL	Shear strength, ab plane.
XCO	Longitudinal compressive strength at inflection point (positive value).
XTO	Longitudinal tensile strength at inflection point.
FIO	Fracture angle in pure transverse compression (in degrees, default = 53.0).
SIGY	In-plane shear yield stress.
ETAN	Tangent modulus for in-plane shear plasticity.
BETA	<p>Hardening parameter for in-plane shear plasticity ($0.0 \leq \text{BETA} \leq 1.0$).</p> <p>EQ.0.0: Pure kinematic hardening</p> <p>EQ.1.0: Pure isotropic hardening</p> <p>$0.0 < \text{BETA} < 1.0$: mixed hardening.</p>
PFL	<p>Percentage of layers which must fail until crashfront is initiated. E.g. $\text{PFL} = 80.0$, then 80 % of layers must fail until strengths are reduced in neighboring elements. Default: all layers must fail. A single layer fails if 1 in-plane IP fails ($\text{PFL} > 0$) or if 4 in-plane IPs fail ($\text{PFL} < 0$).</p>

VARIABLE	DESCRIPTION
PUCK	Flag for evaluation and post-processing of Puck's inter-fiber-failure criterion (IFF, see Puck, Kopp and Knops [2002]). EQ.0.0: no evaluation of Puck's IFF-criterion. EQ.1.0: Puck's IFF-criterion will be evaluated.
SOFT	Softening reduction factor for material strength in crashfront elements (default = 1.0).

Remarks:

The failure surface to limit the elastic domain is assembled by four sub-surfaces, representing different failure mechanisms. They are defined as follows:

longitudinal (fiber) tension,

$$\phi_{1+} = \frac{\sigma_{11} - \nu_{12}\sigma_{22}}{X_T} = 1$$

longitudinal (fiber) compression – (transformation to fracture plane),

$$\phi_{1-} = \frac{\langle |\sigma_{12}^m| + \mu_L \sigma_{22}^m \rangle}{S_L} = 1$$

with

$$\mu_L = -\frac{S_L \cos(2\phi_0)}{Y_C \cos^2(\phi_0)}$$

$$\sigma_{22}^m = \sigma_{11} \sin^2(\varphi^c) + \sigma_{22} \cos^2(\varphi^c) - 2|\sigma_{12}| \sin(\varphi^c) \cos(\varphi^c)$$

$$\sigma_{12}^m = (\sigma_{22} - \sigma_{11}) \sin(\varphi^c) \cos(\varphi^c) + |\sigma_{12}| (\cos^2(\varphi^c) - \sin^2(\varphi^c))$$

and

$$\varphi^c = \arctan \left(\frac{1 - \sqrt{1 - 4 \left(\frac{S_L}{X_C} + \mu_L \right) \frac{S_L}{X_C}}}{2 \left(\frac{S_L}{X_C} + \mu_L \right)} \right)$$

transverse (matrix) failure: perpendicular to the laminate mid-plane,

$$\phi_{2+} = \begin{cases} \sqrt{(1-g) \frac{\sigma_{22}}{Y_T} + g \left(\frac{\sigma_{22}}{Y_T} \right)^2 + \left(\frac{\sigma_{12}}{S_L} \right)^2} = 1 & \text{if } \sigma_{22} \geq 0 \\ \frac{\langle |\sigma_{12}| + \mu_L \sigma_{22} \rangle}{S_L} = 1 & \text{if } \sigma_{22} < 0 \end{cases}$$

transverse (matrix) failure: transverse compression/shear,

$$\phi_{2-} = \sqrt{\left(\frac{\tau_T}{S_T}\right)^2 + \left(\frac{\tau_L}{S_L}\right)^2} = 1 \quad \text{if} \quad \sigma_{22} < 0$$

with

$$\begin{aligned} \mu_T &= -\frac{1}{\tan(2\phi_0)} \quad ; \quad S_T = Y_C \cos(\phi_0) \left[\sin(\phi_0) + \frac{\cos(\phi_0)}{\tan(2\phi_0)} \right] \quad ; \quad \theta \\ &= \arctan\left(\frac{-|\sigma_{12}|}{\sigma_{22} \sin(\phi_0)}\right) \end{aligned}$$

$$\tau_T = \langle -\sigma_{22} \cos(\phi_0) [\sin(\phi_0) - \mu_T \cos(\phi_0) \cos(\theta)] \rangle$$

$$\tau_L = \langle \cos(\phi_0) [|\sigma_{12}| + \mu_L \sigma_{22} \cos(\phi_0) \sin(\theta)] \rangle$$

As long as the stress state is located within the failure surface the model behaves orthotropic elastic. The constitutive law is derived on basis of a proper definition for the ply complementary free energy density G , whose second derivative with respect to the stress

tensor leads to the compliance tensor \mathbf{H} .

$$\mathbf{H} = \frac{\partial^2 G}{\partial \sigma^2} = \begin{bmatrix} \frac{1}{(1-d_1)E_1} & -\frac{\nu_{21}}{E_2} & 0 \\ -\frac{\nu_{12}}{E_1} & \frac{1}{(1-d_2)E_2} & 0 \\ 0 & 0 & \frac{1}{(1-d_6)G_{12}} \end{bmatrix} \quad ; \quad \begin{aligned} d_1 &= d_{1+} \frac{\langle \sigma_{11} \rangle}{|\sigma_{11}|} + d_{1-} \frac{\langle -\sigma_{11} \rangle}{|\sigma_{11}|} \\ d_2 &= d_{2+} \frac{\langle \sigma_{22} \rangle}{|\sigma_{22}|} + d_{2-} \frac{\langle -\sigma_{22} \rangle}{|\sigma_{22}|} \end{aligned}$$

Once the stress state reaches the failure criterion a set of scalar damage variables (d_{1-} , d_{1+} , d_{2-} , d_{2+} , d_6) is introduced associated with the different failure mechanisms. A bi-linear (longitudinal direction) and a linear (transverse direction) damage evolution law is utilized to define the development of the damage variables driven by the fracture toughness and a characteristic internal element length to account for objectivity.

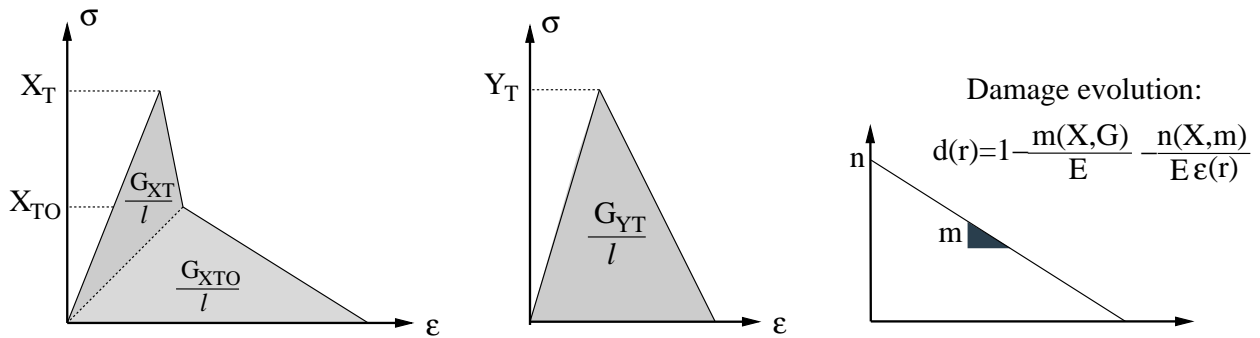

To account for the characteristic non-linear in-plane shear behavior of laminated fiber-reinforced composites a 1D elasto-plastic formulation with linear hardening is coupled to a linear damage behavior once the maximum allowable stress state for shear failure is reached.

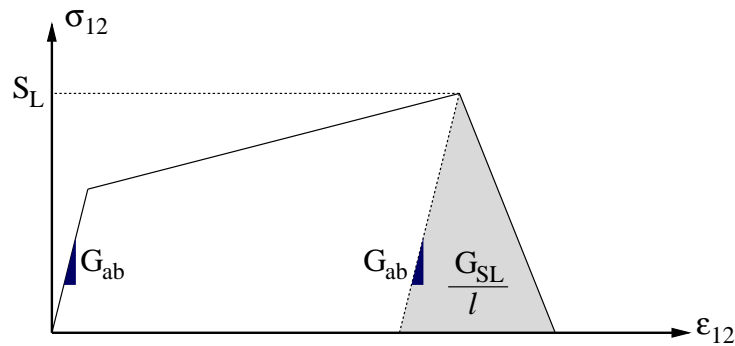

More detailed information about this material model can be found in Maimí, Camanho, Mayugo and Dávila [2007].

When failure has occurred in all the composite layers (through-thickness integration points), the element is deleted. Elements which share nodes with the deleted element become “crashfront” elements and can have their strengths reduced by using the SOFT parameter. An earlier initiation of crashfront elements is possible by using the parameter PFL.

The number of additional integration point variables written to the LS-DYNA database is input by the *DATABASE_EXTENT_BINARY definition with the variable NEIPS (shells) and NEIPH (solids). These additional variables are tabulated below (i = integration point):

History Variable	Description	Value	LS-PrePost history variable
$\phi_{1+}(i)$	fiber tensile mode	$0 \rightarrow 1$: elastic > 1 : damage	1
$\phi_{1-}(i)$	fiber compressive		2
$\phi_{2+}(i)$	tensile matrix mode		3
$\phi_{2-}(i)$	compressive matrix mode		4
$d_{1+}(i)$	damage fiber tension	0 : elastic 1 : fully damaged	5
$d_{1-}(i)$	damage fiber compression		6
$d_2(i)$	damage transverse		7
$d_6(i)$	damage in-plane shear		8
$dam(i)$	crashfront	-1 : element intact 10^{-8} : element in crashfront $+1$: element failed	9
$f_{mt_p}(i)$	tensile matrix mode (Puck criteria)	0 : elastic 1 : failure criterion reached	10
$f_{mc_p}(i)$	compressive matrix mode (Puck criteria)		11
$\theta_{p}(i)$	angle of fracture plane (radians, Puck criteria)		12

***MAT_TISSUE_DISPERSED**

This is Material Type 266. This material is an invariant formulation for dispersed orthotropy in soft tissues, e.g., heart valves, arterial walls or other tissues where one or two collagen fibers are used. The passive contribution is composed of an isotropic and two anisotropic parts. The isotropic part is a simple neo-Hookean model. The first anisotropic part is passive, with two collagen fibers to choose from: (1) a simple exponential model and (2) a more advanced crimped fiber model from Freed et al. [2005]. The second anisotropic part is active described in Guccione et al. [1993] and is used for active contraction.

Card 1	1	2	3	4	5	6	7	8
Variable	MID	R0	F	SIGMA	MU	KAPPA	ACT	INIT
Type	I	F	F	F	F	F	I	I

Card 2	1	2	3	4	5	6	7	8
Variable	FID	ORTH	C1	C2	C3	THETA	NHMOD	
Type	I	I	F	F	F	F	F	

Card 3	1	2	3	4	5	6	7	8
Variable	ACT1	ACT2	ACT3	ACT4	ACT5	ACT6	ACT7	ACT8
Type	F	F	F	F	F	F	F	F

Card 4	1	2	3	4	5	6	7	8
Variable	ACT9	ACT10						
Type	F	F						

Card 5	1	2	3	4	5	6	7	8
Variable	AOPT	BETA	XP	YP	ZP	A1	A2	A3
Type	I	F	F	F	F	F	F	F

Card 6	1	2	3	4	5	6	7	8
Variable	V1	V2	V3	D1	D2	D3		
Type	F	F	F	F	F	F		

VARIABLE**DESCRIPTION**

MID	Material identification. A unique number must be specified.
RO	Mass density.
F	Fiber dispersion parameter governs the extent to which the fiber dispersion extends to the third dimension. $F = 0$ and $F = 1$ apply to 2D splay with the normal to the membrane being in the β and the γ -directions, respectively (see Figure 2-127). $F = 0.5$ applies to 3D splay with transverse isotropy. Splay will be orthotropic whenever $F \neq 0.5$. This parameter is ignored if $INIT = 1$.
SIGMA	The parameter SIGMA governs the extent of dispersion, such that as SIGMA goes to zero, the material symmetry reduces to pure transverse isotropy. Conversely, as SIGMA becomes large, the material symmetry becomes isotropic in the plane. This parameter is ignored if $INIT = 1$.
MU	MU is the isotropic shear modulus that models elastin. MU should be chosen such that the following relation is satisfied: $0.5 (3KAPPA - 2MU) / (3KAPPA + MU) < 0.5.$ Instability can occur for implicit simulations if this quotient is close to 0.5. A modest approach is a quotient between 0.495 and 0.497.
KAPPA	Bulk modulus for the hydrostatic pressure.

VARIABLE	DESCRIPTION
ACT	ACT = 1 indicates that an active model will be used that acts in the mean fiber-direction. The active model, like the passive model, will be dispersed by SIGMA and F, or if INIT = 1, with the *INITIAL_FIELD_SOLID keyword.
INIT	INIT = 1 indicates that the anisotropy eigenvalues will be given by *INITIAL_FIELD_SOLID variables in the global coordinate system (see Remark 1).
FID	The passive fiber model number. There are two passive models available: FID = 1 or FID = 2. They are described in Remark 2.
ORTH	ORTH specifies the number (1 or 2) of fibers used. When ORTH = 2 two fiber families are used and arranged symmetrically THETA degrees from the mean fiber direction and lying in the tissue plane.
C1-C3	Passive fiber model parameters.
THETA	The angle between the mean fiber direction and the fiber families. The parameter is active only if ORTH = 2 and is particularly important in vascular tissues (e.g. arteries)
NHMOD	Neo-Hooke model flag EQ.0.0: original implementation (modified Neo-Hooke) EQ.1.0: standard Neo-Hooke model (as in umat45 of dyn21.f)
ACT1 - ACT10	Active fiber model parameters. Note that ACT10 is an input for a time dependent load curve that overrides some of the ACTx values. See section 2 below.
AOPT	Material axes option (see MAT_OPTIONTROPIC_ELASTIC for a more complete description): EQ.0.0: locally orthotropic with material axes determined by element nodes 1, 2, and 4, as with *DEFINE_COORDINATE_NODES. EQ.2.0: globally orthotropic with material axes determined by vectors defined below, as with *DEFINE_COORDINATE_VECTOR. EQ.3.0: locally orthotropic material axes determined by rotating the material axes about the element normal by an angle, BETA, from a line in the plane of the element defined by the cross product of the vector v with the element nor-

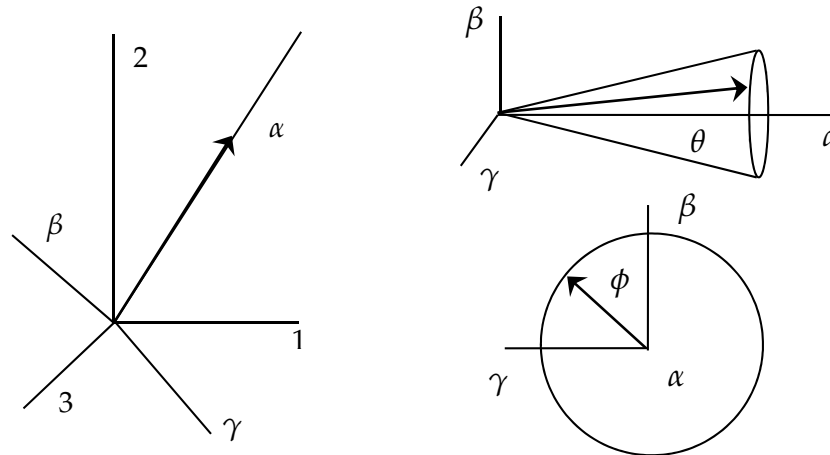

Figure 2-127. The plot on the left relates the global coordinates (1, 2, 3) to the local coordinates (α, β, γ) , selected so the mean fiber direction in the reference configuration is align with the α -axis. The plots on the right show how the unit vector for a specific fiber within the fiber distribution of a 3D tissue is oriented with respect to the mean fiber direction via angles θ and ϕ .

VARIABLE	DESCRIPTION
	mal.
	LT.0.0: the absolute value of AOPT is a coordinate system ID number (CID on *DEFINE_COORDINATE_NODES, *DEFINE_COORDINATE_SYSTEM or *DEFINE_COORDINATE_VECTOR). Available with the R3 release of Version 971 and later.
BETA	Material angle in degrees for AOPT = 3, may be overridden on the element card *ELEMANT_SOLID_ORTHO.
P1 - P3	P1, P2 and P3 define the coordinates of point P for AOPT = 1 and AOPT = 4.
A1 - A3	A1, A2 and A3 define the components of vector A for AOPT = 2.
D1 - D3	D1, D2 and D3 define components of vector D for AOPT = 2.
V1 - V3	V1, V2 and V3 define components of vector V for AOPT = 3 and AOPT = 4.

Details of the passive model can be found in Freed et al. (2005) and Einstein et al. (2005). The stress in the reference configuration consists of a deviatoric matrix term, a hydrostatic pressure term, and either one (ORTHO = 1) or two (ORTH = 2) fiber terms:

$$\mathbf{S} = \kappa J(J-1)\mathbf{C}^{-1} + \mu J^{-2/3} \mathbf{DEV} \left[\frac{1}{4} (\mathbf{I} - \bar{\mathbf{C}}^{-2}) \right] + J^{-2/3} \sum_{i=1}^n [\sigma_i(\lambda_i) + \varepsilon_i(\lambda_i)] \mathbf{DEV}[\mathbf{K}_i]$$

where \mathbf{S} is the second Piola-Kirchhoff stress tensor, J is the Jacobian of the deformation gradient, κ is the bulk modulus, σ_i is the passive fiber stress model used, and ε_i is the corresponding active fiber model used. The operator \mathbf{DEV} is the deviatoric projection:

$$\mathbf{DEV}[\bullet] = (\bullet) - \frac{1}{3} \text{tr}[(\bullet)\mathbf{C}]\mathbf{C}^{-1}$$

where \mathbf{C} is the right Cauchy-Green deformation tensor. The dispersed fourth invariant $\lambda = \sqrt{\text{tr}[\mathbf{K}\bar{\mathbf{C}}]}$, where $\bar{\mathbf{C}}$ is the isochoric part of the Cauchy-Green deformation. Note that λ is not a stretch in the classical way, since \mathbf{K} embeds the concept of dispersion. \mathbf{K} is called the dispersion tensor or anisotropy tensor and is given in global coordinates. The passive and active fiber models are defined in the fiber coordinate system. In effect the dispersion tensor rotates and weights these one dimensional models, such that they are both three-dimensional and in the Cartesian framework.

In the case where, the splay parameters SIGMA and F are specified, \mathbf{K} is given by:

$$\mathbf{K}_i = \frac{1}{2} \mathbf{Q}_i \begin{bmatrix} 1 + e^{-2\text{SIGMA}^2} & 0 & 0 \\ 0 & F(1 - e^{-2\text{SIGMA}^2}) & 0 \\ 0 & 0 & (1 - F)(1 - e^{-2\text{SIGMA}^2}) \end{bmatrix} \mathbf{Q}_i^T$$

where \mathbf{Q} is the transformation tensor that rotates from the local to the global Cartesian system. In the case when INIT = 1, the dispersion tensor is given by

$$\mathbf{K}_i = \mathbf{Q}_i \begin{pmatrix} \chi_i^1 & 0 & 0 \\ 0 & \chi_i^2 & 0 \\ 0 & 0 & \chi_i^3 \end{pmatrix} \mathbf{Q}_i^T$$

where the χ :s are given on the *INITIAL_FIELD_SOLID card. For the values to be physically meaningful $\chi_i^1 + \chi_i^2 + \chi_i^3 = 1$. It is the responsibility of the user to assure that this condition is met, no internal checking for this is done. These values typically come from diffusion tensor data taken from the myocardium.

Remarks:

1. Passive fiber models. Currently there are two models available.
 - a) If FID = 1 a crimped fiber model is used. It is solely developed for collagen fibers. Given H_0 and R_0 compute:

$$L_0 = \sqrt{(2\pi)^2 + (H_0)^2}, \Lambda = \frac{L_0}{H_0}$$

and

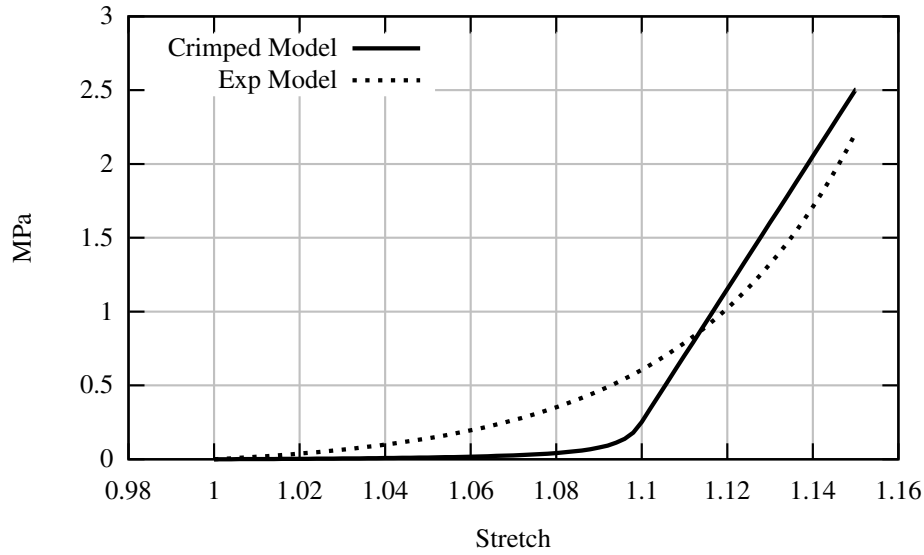

Figure 2-128. both the Crimped and the Exponential fiber models visualized. Here $\Lambda = 1.1$ is the transition point in the crimped model.

$$E_s = \frac{E_f H_0}{H_0 + \left(1 + \frac{37}{6\pi^2} + 2\frac{L_0^2}{\pi^2}\right) (L_0 - H_0)}$$

Now if the fiber stretches $\lambda < \Lambda$ the fiber stress is given by:

$$\sigma = \zeta E_s (\lambda - 1)$$

where

$$\zeta = \frac{6\pi^2 (\Lambda^2 + (4\pi^2 - 1)\lambda^2)\lambda}{\Lambda (3H_0^2 (\Lambda^2 - \lambda^2) (3\Lambda^2 + (8\pi^2 - 3)\lambda^2) + 8\pi^2 (10\Lambda^2 + (3\pi^2 - 10)\lambda^2))}$$

and if $\lambda > \Lambda$ the fiber stress equals:

$$\sigma = E_s (\lambda - 1) + E_f (\lambda - \Lambda).$$

In [Figure 2-127](#) the fiber stress is rendered with $H_0 = 27.5$, $R_0 = 2$ and the transition point becomes $\Lambda = 1.1$.

- b) The second fiber model available (FID = 2) is a simpler but more useful model for the general fiber reinforced rubber. The fiber stress is simply given by:

$$\sigma = C_1 \left[e^{\frac{C_2}{2}(\lambda^2 - 1)} - 1 \right].$$

The difference between the two fiber models is given in [Figure 2-128](#).

The active model for myofibers (ACT = 1) is defined in Guccione et al. (1993) and is given by:

$$\sigma = T_{\max} \frac{Ca_0^2}{Ca_0^2 + ECa_{50}^2} C(t)$$

where

$$ECa_{50}^2 = \frac{(Ca_0)_{\max}}{\sqrt{e^{B(l_r\sqrt{2(\lambda-1)+1}-l_0)}-1}}$$

and B is a constant, $(Ca_0)_{\max}$ is the maximum peak intracellular calcium concentration, l_0 is the sarcomere length at which no active tension develops and l_r is the stress free sarcomere length. The function $C(t)$ is defined in one of two ways. First it can be given as:

$$C(t) = \frac{1}{2} (1 - \cos\omega(t))$$

where

$$\omega = \begin{cases} \pi \frac{t}{t_0} & 0 \leq t < t_0 \\ \pi \frac{t - t_0 + t_r}{t_r} & t_0 \leq t < t_0 + t_r \\ 0 & t_0 + t_r \leq t \end{cases}$$

and $t_r = ml_R\lambda + b$. Secondly, it can also be given as a load curve. If a load curve should be used its index must be given in ACT10. Note that all variables that correspond to ω are neglected if a load curve is used. The active parameters on Card 3 and 4 are interpreted as:

ACT1	ACT2	ACT3	ACT4	ACT5	ACT6	ACT7	ACT8	ACT9	ACT10
T_{\max}	Ca_0	$(Ca_0)_{\max}$	B	l_0	t_0	m	b	l_R	LCID

References:

1. Freed AD., Einstein DR. and Vesely I., Invariant formulation for dispersed transverse isotropy in aortic heart valves – An efficient means for modeling fiber splay, Biomechan model Mechanobiol, 4, 100-117, 2005.
2. Guccione JM., Waldman LK., McCulloch AD., Mechanics of Active Contraction in Cardiac Muscle: Part II – Cylindrical Models of the Systolic Left Ventricle, J. Bio Mech, 115, 82-90, 1993.

***MAT_EIGHT_CHAIN_RUBBER**

This is Material Type 267. This is an advanced rubber-like model that is tailored for glassy polymers and similar materials. It is based on Arruda's eight chain model but enhanced with non elastic properties.

Card 1	1	2	3	4	5	6	7	8
Variable	MID	RO	K	MU	N	MULL	VISPL	VISEL
Type	I	F	F	F	I	I	I	I
Default	none	none	0.0	0.0	0	0	0	0

Card 2	1	2	3	4	5	6	7	8
Variable	YLD0	FP	GP	HP	LP	MP	NP	PMU
Type	F	F	F	F	F	F	F	F
Default	0.0	0.0	0.0	0.0	0.0	0.0	0.0	0.0

Card 3	1	2	3	4	5	6	7	8
Variable	M1	M2	M3	M4	M5	TIME	VCON	
Type	F	F	F	F	F	F	F	
Default	See MULL	See MULL	See MULL	See MULL	See MULL	0.0	9.0	

MAT_267**MAT_EIGHT_CHAIN_RUBBER**

Card 4	1	2	3	4	5	6	7	8
Variable	Q1	B1	Q2	B2	Q3	B3	Q4	B4
Type	F	F	F	F	F	F	F	F
Default	0.0	0.0	0.0	0.0	0.0	0.0	0.0	0.0

Card 5	1	2	3	4	5	6	7	8
Variable	K1	S1	K2	S2	K3	S3		
Type	F	F	F	F	F	F		
Default	0.0	0.0	0.0	0.0	0.0	0.0		

Card 6	1	2	3	4	5	6	7	8
Variable	AOPT	MACF	XP	YP	ZP	A1	A2	A3
Type	F	F	F	F	F	F	F	F
Default	0.0	0.0	0.0	0.0	0.0	0.0	0.0	.0.0

Card 7	1	2	3	4	5	6	7	8
Variable	V1	V2	V3	D1	D2	D3	THETA	
Type	F	F	F	F	F	F	F	
Default	0.0	0.0	0.0	0.0	0.0	0.0	0.0	

Card 8-14	1	2	3	4	5	6	7	8
Variable	TAUi	BETAI						
Type	F	F						
Default	0.0	0.0						

VARIABLE

DESCRIPTION

MID	Material identification. A unique number must be specified
RO	Mass density.
K	<p>Bulk modulus. To get almost incompressible behavior set this to one or two orders of magnitude higher than MU. Note that the Poisson's ratio should be kept at a realistic value.</p> $v = \frac{3K - 2MU}{2(3K + MU)}$
MU	<p>Shear modulus. MU is the product of the number of molecular chains per unit volume (n), Boltzmann's constant (k) and the absolute temperature (T). Thus MU = nkT.</p>
MULL	<p>Parameter describing which softening algorithm that shall be used.</p> <p>EQ.1: Strain based Mullins effect from Qi and Boyce, see theory section below for details</p> <p>M1 = A (Qi recommends 3.5) M2 = B (Qi recommends 18.0) M3 = Z (Qi recommends 0.7) M4 = vs (between 0 and 1 and less than vss) M5 = vss (between 0 and 1 and greater than vs)</p> <p>EQ.2: Energy based Mullins, a modified version of Roxburgh and Ogden model. M1 > 0, M2 > 0 and M3 > 0 must be set. See Theory section for details.</p>

VARIABLE	DESCRIPTION
VISPL	<p>Parameter describing which viscoplastic formulation that should be used, see the theory section for details.</p> <p>EQ.0: No viscoplasticity.</p> <p>EQ.1: 2 parameters standard model, K1 and S1 must be set.</p> <p>EQ.2: 6 parameters G'Sells model, K1,K2,K3,S1,S2 and S3 must be set.</p> <p>EQ.3: 4 parameters Strain hardening model, K1,K2,S1,S2 must be set.</p>
VISEL	<p>Option for viscoelastic behavior, see the theory section for details.</p> <p>EQ.0: No viscoelasticity.</p> <p>EQ.1: Free energy formulation based on Holzapfel and Ogden.</p> <p>EQ.2: Formulation based on stiffness ratios from Simo et al.</p>
YLD0	<p>Initial yield stress.</p> <p>EQ.0.0: No plasticity</p> <p>GT.0.0: Initial yield stress: Hardening is defined seperately.</p> <p>LT.0.0: -YLD0 is taken as the load curve ID for the yield stress versus effective plastic strain.</p>
FP-NP	<p>Parameters for Hill's general yield surface. For von mises yield criteria set FP = GP = HP = 0.5 and LP = MP = NP = 1.5.</p>
PMU	<p>Kinematic hardening parameter. It is usually equal to MU.</p>
M1 - M5	<p>Mullins parameters</p> <p>MULL.EQ.1: M1 - M5 are used</p> <p>MULL.EQ.2: M1 - M3 are used.</p>
TIME	<p>A time filter that is used to smoothen out the time derivate of the strain invariant over a TIME interval. Default is no smoothening but a value 100*TIMESTEP is recommended.</p>
VCON	<p>A material constant for the volumetric part of the strain energy. Default 9.0 but any value can be used to tailor the volumetric response. For example -2.</p>
Q1 - B4	<p>Voce hardening parameters</p>

VARIABLE	DESCRIPTION
K1 - S3	<p>Viscoplastic parameters.</p> <p>VISPL.EQ.1: K1 and S1 are used.</p> <p>VISPL.EQ.2: K1, S1, K2, S2, K3 and S3 are used.</p> <p>VISPL.EQ.3: K1, S1 and K2 are used.</p>
AOPT	<p>Material axes option (see *MAT_OPTIONTROPIC_ELASTIC, *MAT_002) for a more complete description.</p> <p>EQ.0.0: Locally orthotropic with material axes defined by element nodes 1, 2 and 4.</p> <p>EQ.1.0: Locally orthotropic with material axes determined by a point in space and the global location of the element center; this is the a-direction.</p> <p>EQ.2.0: Globally orthotropic with material axes determined by vectors defined below.</p> <p>EQ.3.0: Locally orthotropic material axes determined by rotating the material axes about the element normal by an angle THETA. The angle is defined from the line in the plane that is defined by the cross product of the vector \mathbf{v} with the element normal. The plane of a solid is defined as the midsurface between the inner surface and the outer surface defined by the first 4 nodes and last 4 nodes.</p> <p>EQ.4.0: Locally orthotropic in cylindrical coordinate system with the material axes determined by a vector \mathbf{v} and an originating point P.</p>
MACF	<p>Material axes change flag</p> <p>EQ.1.0: No change (default)</p> <p>EQ.2.0: Switch axes a and b</p> <p>EQ.3.0: Switch axes a and c</p> <p>EQ.4.0: Switch axes b and c</p>
XP, YP, ZP	Define coordinates for point P for AOPT = 1 and 4
A1, A2, A3	Define components of vector \mathbf{a} for AOPT = 2.
D1, D2, D3	Define components of vector \mathbf{d} for AOPT = 2
V1, V2, V3	Define components of vector \mathbf{v} for AOPT = 3 and 4

VARIABLE	DESCRIPTION
TAUi	Relaxation time. A maximum of 6 values can be used.
BETAi / GAMMAi	<p>VISEL.EQ.1: Dissipating energy factors.(see Holzapfel)</p> <p>VISEL.EQ.2: Gamma factors (see Simo)</p>

Basic theory:

This model is based on the work done by Arruda and Boyce [1993], in particular Arruda’s thesis [1992]. The eight chain rubber model is based on hyper elasticity and it is formulated by using strain invariants. The strain softening is taken from work done by Qi and Boyce [2004], where the strain energy used is defined as

$$\Psi = v_s \mu \left[\sqrt{N} \Lambda_c \beta + N \ln \left(\frac{\beta}{\sinh \beta} \right) \right] + \Psi_2 = \Psi_1 + \Psi_2,$$

where the amplified chain stretch is given by $\Lambda_c = \sqrt{X(\bar{\lambda}^2 - 1) + 1}$ and

$$\beta = L^{-1} \left(\frac{\Lambda_c}{\sqrt{N}} \right),$$

where $\bar{\lambda}^2 = I_1/3$, μ is the initial modulus of the soft domain, N is the number of rigid links between crosslinks of the soft domain region. $X = 1 + A(1 - v_s) + B(1 - v_s)^2$, is a general polynomial describing the interaction between the soft and the hard phases (Qi and Boyce [2004] and Tobin and Mullins [1957]). The compressible behavior is described by the strain energy.

$$\Psi_2 = \frac{1}{v_{con}} \left(v_{con} \ln J + \frac{1}{J^{v_{con}}} - 1 \right)$$

Where J is the determinant of the elastic deformation gradient \mathbf{F}_e . The Cauchy stress is then computed as:

$$\sigma = \frac{2}{J} \mathbf{F}_e \frac{\partial \Psi}{\partial \mathbf{C}_e} \mathbf{F}_e^T = \frac{1}{J} \mathbf{F}_e (\mathbf{S}_1 + \mathbf{S}_2) \mathbf{F}_e^T = \frac{v_s X \mu \sqrt{N}}{3J \Lambda_c} L^{-1} \left(\frac{\Lambda_c}{\sqrt{N}} \right) \left(\mathbf{B}_e - \frac{1}{3} I_1 \mathbf{I} \right) + \frac{2K}{J v_{con}} \left(1 - \frac{1}{J^{v_{con}}} \right)$$

where \mathbf{S}_1 and \mathbf{S}_2 are second Piola-Kirchhoff stresses based on Ψ_1 and Ψ_2 respectively.

Mullins effect:

Two models for the Mullins effect are implemented.

1. MULL = 1

The strain softening is developed by the evolution law taken from Boyce 2004:

$$\dot{v}_s = Z(v_{ss} - v_s) \frac{\sqrt{N} - 1}{(\sqrt{N} - \Lambda_c^{\max})^2} \dot{\Lambda}_c^{\max},$$

where Z is a parameter that characterizes the evolution in v_s with increasing $\dot{\Lambda}_c^{\max}$. The parameter v_{ss} is the saturation value of v_s . Note that $\dot{\Lambda}_c^{\max}$ is the maximum of Λ_c from the past:

$$\dot{\Lambda}_c^{\max} = \begin{cases} 0 & \Lambda_c < \Lambda_c^{\max} \\ \dot{\Lambda}_c & \Lambda_c > \Lambda_c^{\max} \end{cases}$$

The structure now evolves with the deformation. The dissipation inequality requires that the evolution of the structure is irreversible $\dot{v}_s \geq 0$. See Qi and Boyce [2004].

2. MULL = 3

The energy driven model based on Ogden and Roxburgh. When activated the strain energy is automatically transformed to a standard eight chain model. That is, the variables Z , v_s and X is automatically set to 0, 1 and 1 respectively. The stress is multiplicative split of the true stress and the softening factor η .

$$\bar{\sigma} = \eta\sigma, \quad \eta = 1 - \frac{1}{M1} \operatorname{erf} \left(\frac{\Psi_1^{\max} - \Psi_1}{M3 - M2\Psi_1^{\max}} \right).$$

Viscoelasticity:

1. VISEL = 1

The viscoelasticity is based on work done by Holzapfel (2004)

$$\dot{\mathbf{Q}}_\alpha + \frac{\mathbf{Q}_\alpha}{\tau_\alpha} = 2\beta_\alpha \frac{d}{dt} \frac{\partial \Psi_1}{\partial \mathbf{C}_e} = \beta_\alpha \dot{\mathbf{S}}_1$$

where α is the number of viscoelastic terms (0, 1, ..., 6).

2. VISEL = 2

With this option the evolution is based on work done by Simo and Hughes (2000).

$$\dot{\mathbf{Q}}_\alpha + \frac{\mathbf{Q}_\alpha}{\tau_\alpha} = 2 \frac{\gamma_a}{\tau_a} \frac{d}{dt} \frac{\partial \Psi_1}{\partial \mathbf{C}_e} = \frac{\gamma_a}{\tau_a} \mathbf{S}_1$$

The the number of Prony terms is restricted to maximum 6 and $\tau > 0, \gamma > 0$.

The Cauchy stress is obtained by a push forward operation on the total second Piola-Kirchhoff stress.

$$\boldsymbol{\sigma} = \frac{1}{J} \mathbf{F}_e \mathbf{S} \mathbf{F}_e^T.$$

Viscoplasticity:

The plasticity is based on the general Hills' yield surface

$$\sigma_{\text{eff}}^2 = F(\sigma_{22} - \sigma_{33})^2 + G(\sigma_{33} - \sigma_{11})^2 + H(\sigma_{11} - \sigma_{22})^2 + 2L\sigma_{12}^2 + 2M\sigma_{23}^2 + 2N\sigma_{13}^2$$

and the hardening is either based on a load curve ID (-YLD0) or an extended Voce hardening

$$\sigma_{\text{yld}} = \sigma_{\text{yld0}} + Q_1(1 - e^{B_1\bar{\epsilon}}) + Q_2(1 - e^{B_2\bar{\epsilon}}) + Q_3(1 - e^{B_3\bar{\epsilon}}) + Q_4(1 - e^{B_4\bar{\epsilon}}).$$

The yield criterion is written

$$f = \sigma_{\text{eff}} - \sigma_{\text{yld}} \leq 0.$$

Adding the viscoplastic phenomena, we simply add one evolution equation for the effective plastic strain rate. Three different formulations is available.

1. VISPL = 1

$$\dot{\epsilon}_{\text{vp}} = \left(\frac{f}{K_1} \right)^{S_1}.$$

where K_1 and S_1 are viscoplastic material parameters.

2. VISPL = 2

$$\dot{\epsilon}_{\text{vp}} = \left[\frac{f}{K_1(1 - e^{-S_1(\epsilon_{\text{vp}} + K_2)})e^{S_2\epsilon_{\text{vp}}^{K_3}}} \right]^{S_3}$$

Where K_1, K_2, K_3, S_1, S_2 and S_3 are viscoplastic parameters

3. VISPL = 3

$$\dot{\epsilon}_{\text{vp}} = \left(\frac{f}{K_1} \right)^{S_1} (\epsilon_{\text{vp}} + K_2)^{S_2}$$

Where K_1, K_2, S_1 and S_2 are viscoplastic parameters.

Kinematic hardening:

The back stress is calculated similar to the Cauchy stress above but without the softening factors:

$$\beta = \frac{\mu_p \sqrt{N}}{3J \Lambda_c} L^{-1} \left(\frac{\Lambda_c}{\sqrt{N}} \right) \left(\mathbf{I} - \frac{1}{3} I_p \mathbf{C}_p^{-1} \right)$$

μ_p is a hardening material parameter (PMU). The total Piola-Kirchhoff stress is now given by $\mathbf{S}^* = \mathbf{S} - \beta$ and the total stress is given by a standard push forward operation with the elastic deformation gradient.

Remarks:

1. The parameter PMU is usually taken the same as MU.
2. For the case of a dilute solution the Mullins parameter A should be equal to 3.5. See Qi and Boyce [2004].
3. For a system with well dispersed particles B should somewhere around 18. See Qi and Boyce [2004].

References:

Qi HJ., Boyce MC., Constitutive model for stretch-induced softening of stress-stretch behavior of elastomeric materials, *Journal of the Mechanics and Physics of Solids*, 52, 2187-2205, 2004.

Arrude EM., Characterization of the strain hardening response of amorphous polymers, PhD Thesis, MIT, 1992.

Mullins L., Tobin NR., Theoretical model for the elastic behavior of filler reinforced vulcanized rubber, *Rubber Chem. Technol.*, 30, 555-571, 1957.

Ogden RW. Roxburgh DG., A pseudo-elastic model for the Mullins effect in Filled rubber., *Proc. R. Soc. Lond. A.*, 455, 2861-2877, 1999.

Simo JC., Hughes TJR., *Computational Inelasticity*, Springer, New York, 2000.

Holzappel GA., *Nonlinear Solid Mechanics*, Wiley, New-York, 2000.

***MAT_BERGSTROM_BOYCE_RUBBER**

This is material type 269. This is a rubber model based on the Arruda and Boyce (1993) chain model accompanied with a viscoelastic contribution according to Bergström and Boyce (1998). The viscoelastic treatment is based on the physical response of a single entangled chain in an embedded polymer gel matrix and the implementation is based on Dal and Kaliske (2009). This model is only available for solid elements.

Card 1	1	2	3	4	5	6	7	8
Variable	MID	RO	K	G	GV	N	NV	
Type	A8	F	F	F	F	F	F	
Default	none	none	none	none	none	none	none	

Card 2	1	2	3	4	5	6	7	8
Variable	C	M	GAMO	TAUH				
Type	F	F	F	F				
Default	none	none	none	none				

VARIABLE**DESCRIPTION**

MID	Material identification. A unique number or label not exceeding 8 characters must be specified.
RO	Mass density.
K	Elastic bulk modulus
G	Elastic shear modulus
GV	Viscoelastic shear modulus
N	Elastic segment number

VARIABLE	DESCRIPTION
NV	Viscoelastic segment number
C	Inelastic strain exponent, should be less than zero
M	Inelastic stress exponent
TAUH	Reference Kirchhoff stress

Remarks:

The deviatoric Kirchhoff stress for this model is the sum of an elastic and viscoelastic part according to

$$\bar{\boldsymbol{\tau}} = \boldsymbol{\tau}_e + \boldsymbol{\tau}_v$$

The elastic part is governed by the Arruda-Boyce strain energy potential resulting in the following expression (after a Pade approximation of the Langevin function)

$$\boldsymbol{\tau}_e = \frac{G}{3} \frac{3 - \lambda_r^2}{1 - \lambda_r^2} \left(\bar{\mathbf{b}} - \frac{Tr(\bar{\mathbf{b}})}{3} \mathbf{I} \right)$$

Here G is the elastic shear modulus,

$$\bar{\mathbf{b}} = J^{-2/3} \mathbf{F} \mathbf{F}^T$$

$$J = \det \mathbf{F}$$

is the unimodular left Cauchy-Green tensor, and

$$\lambda_r^2 = \frac{Tr(\bar{\mathbf{b}})}{3N}$$

is the relative network stretch.

The viscoelastic stress is based on a multiplicative split of the unimodular deformation gradient into unimodular elastic and inelastic parts, respectively,

$$J^{-1/3} \mathbf{F} = \mathbf{F}_e \mathbf{F}_i$$

and we define

$$\mathbf{b}_e = \mathbf{F}_e \mathbf{F}_e^T$$

to be the elastic left Cauchy-Green tensor. The viscoelastic stress is given as

$$\boldsymbol{\tau}_v = \frac{G_v}{3} \frac{3 - \lambda_v^2}{1 - \lambda_v^2} \left(\mathbf{b}_e - \frac{Tr(\mathbf{b}_e)}{3} \mathbf{I} \right)$$

where

$$\lambda_v^2 = \frac{Tr(\mathbf{b}_e)}{3N_v}$$

is the relative network stretch for the viscoelastic part. The evolution of the elastic left Cauchy-Green tensor can be written

$$\dot{\mathbf{b}}_e = \bar{\mathbf{L}}\mathbf{b}_e + \mathbf{b}_e\bar{\mathbf{L}}^T - 2\mathbf{D}_i\mathbf{b}_e$$

where the inelastic rate-of-deformation tensor is given as

$$\mathbf{D}_i = \dot{\gamma}_0 (\lambda_i - 0.999)^c \left(\frac{\|\boldsymbol{\tau}_v\|}{\hat{\tau}\sqrt{2}} \right)^m \frac{\boldsymbol{\tau}_v}{\|\boldsymbol{\tau}_v\|}$$

and

$$\bar{\mathbf{L}} = \mathbf{L} - \frac{Tr(\mathbf{L})}{3} \mathbf{I}$$

is the deviatoric velocity gradient. The stretch of a single chain relaxing in a polymer is linked to the inelastic right Cauchy-Green tensor as

$$\lambda_i^2 = \frac{Tr(\mathbf{F}_i^T \mathbf{F}_i)}{3} \geq 1,$$

and this stretch is available as the plastic strain variable in the post processing of this material. The volumetric part is elastic and governed by the bulk modulus, the pressure for this model is given as

$$p = K(J^{-1} - 1).$$

***MAT_CWM**

This is material type 270. This is a thermo-elastic-plastic model with kinematic hardening that allows for material creation as well as annealing triggered by temperature. The acronym CWM stands for Computational Welding Mechanics, Lindström (2013), and the model is intended to be used for simulating multistage weld processes. This model is only available for solid elements.

Card 1	1	2	3	4	5	6	7	8
Variable	MID	RO	LCEM	LCPR	LCSY	LCHR	LCAT	BETA
Type	A8	F	F	F	F	F	F	F
Default	none	none	none	none	none	none	none	none

Card 2	1	2	3	4	5	6	7	8
Variable	TASTART	TAEND	TLSTART	TLEND	EGHOST	PGHOST	AGHOST	
Type	F	F	F	F	F	F	F	
Default	none	none	none	none	none	none	none	

Optional Phase Change Card.

Card 3	1	2	3	4	5	6	7	8
Variable	T2PHASE	T1PHASE						
Type	F	F						
Default	optional	optional						

VARIABLE

DESCRIPTION

MID

Material identification. A unique number or label not exceeding 8 characters must be specified.

RO	Material density
LCEM	Load curve for Young's modulus as function of temperature
LCPR	Load curve for Poisson's ratio as function of temperature
LCSY	Load curve for yield stress as function of temperature
LCHR	Load curve for hardening modulus as function of temperature
LCAT	Load curve (or table) for thermal expansion coefficient as function of temperature (and maximum temperature up to current time)
BETA	Fraction isotropic hardening between 0 and 1 EQ.0: Kinematic hardening EQ.1: Isotropic hardening
TASTART	Annealing temperature start
TAEND	Annealing temperature end
TLSTART	Birth temperature start
TLEND	Birth temperature end
EGHOST	Young's modulus for ghost (quiet) material
PGHOST	Poisson's ratio for ghost (quiet) material
AGHOST	Thermal expansion coefficient for ghost (quiet) material
T2PHASE	Temperature at which phase change commences
T1PHASE	Temperature at which phase change ends

Remarks:

This material is initially in a quiet state, sometimes referred to as a ghost material. In this state the material has the thermo-elastic properties defined by the quiet Young's modulus, quiet Poisson's ratio and quiet thermal expansion coefficient. These should represent void, i.e., the Young's modulus should be small enough to not influence the surroundings but large enough to avoid numerical problems. A quiet material stress should never reach the yield point. When the temperature reaches the birth temperature, a history variable representing the indicator of the welding material is incremented. This variable follows

$$\gamma(t) = \min \left(1, \max \left[0, \frac{T_{max} - T_l^{\text{start}}}{T_l^{\text{end}} - T_l^{\text{start}}} \right] \right)$$

where $T_{max} = \max_{s \leq t} T(s)$. This parameter is available as history variable 9 in the output database. The effective thermo-elastic material properties are interpolated as

$$E = E(T)\gamma + E_{quiet}(1 - \gamma)$$

$$\nu = \nu(T)\gamma + \nu_{quiet}(1 - \gamma)$$

$$\alpha = \alpha(T, T_{max})\gamma + \alpha_{quiet}(1 - \gamma)$$

where E , ν , and α are the Young's modulus, Poisson's ratio and thermal expansion coefficient, respectively. Here, the thermal expansion coefficient is either a temperature dependent curve, or a collection of temperature dependent curves, ordered in a table according to maximum temperature T_{max} . The stress update then follows a classical isotropic associative thermo-elastic-plastic approach with kinematic hardening that is summarized in the following. The explicit temperature dependence is sometimes dropped for the sake of clarity.

The stress evolution is given as

$$\dot{\sigma} = \mathbf{C}(\dot{\epsilon} - \dot{\epsilon}_p - \dot{\epsilon}_T)$$

where \mathbf{C} is the effective elastic constitutive tensor and

$$\dot{\epsilon}_T = \alpha \dot{T} \mathbf{I}$$

$$\dot{\epsilon}_p = \dot{\epsilon}_p \frac{3 \mathbf{s} - \boldsymbol{\kappa}}{\bar{\sigma}}$$

are the thermal and plastic strain rates, respectively. The latter expression includes the deviatoric stress

$$\mathbf{s} = \sigma - \frac{1}{3} \text{Tr}(\sigma) \mathbf{I},$$

the back stress $\boldsymbol{\kappa}$ and the effective stress

$$\bar{\sigma} = \sqrt{\frac{3}{2} (\mathbf{s} - \boldsymbol{\kappa}) : (\mathbf{s} - \boldsymbol{\kappa})}$$

that are involved in the plastic equations. To this end, the effective yield stress is given as

$$\sigma_Y = \sigma_Y(T) + \beta H(T) \epsilon_p$$

and plastic strains evolve when the effective stress exceeds this value. The back stress evolves as

$$\dot{\boldsymbol{\kappa}} = (1 - \beta) H(T) \dot{\epsilon}_p \frac{\mathbf{s} - \boldsymbol{\kappa}}{\bar{\sigma}}$$

where $\dot{\epsilon}_p$ is the rate of effective plastic strain that follows from consistency equations.

When the temperature reaches the start annealing temperature, the material starts assuming its virgin properties. Beyond the start annealing temperature it behaves as an ideal elastic-plastic material but with no evolution of plastic strains. The resetting of effective plastic properties in the annealing temperature interval is done by modifying the effective plastic strain and back stress before the stress update as

$$\varepsilon_p^{n+1} = \varepsilon_p^n \max \left[0, \min \left(1, \frac{T - T_a^{\text{end}}}{T_a^{\text{start}} - T_a^{\text{end}}} \right) \right]$$
$$\kappa^{n+1} = \kappa^n \max \left[0, \min \left(1, \frac{T - T_a^{\text{end}}}{T_a^{\text{start}} - T_a^{\text{end}}} \right) \right]$$

The optional Card 3 is used to set history variable 11, which is the average temperature rate by which the temperature has gone from T2PHASE to T1PHASE. To fringe this variable the range should be set to positive values since it is during the simulation temporarily used to store the time when the material has reached temperature T2PHASE and is then stored as a negative value. A strictly positive value means that the material has reached temperature T2PHASE and gone down to T1PHASE and the history variable is $(T2PHASE - T1PHASE) / (T1 - T2)$, where T2 is the time when temperature T2PHASE is reached and T1 is the time when temperature T1PHASE is reached. Note that T2PHASE.GT.T1PHASE and T1.GT.T2. A value of zero means that the element hasn't reached temperature T2PHASE and a strictly negative value means that the element has reached temperature T2PHASE but not T1PHASE subsequently

***MAT_POWDER**

This is material type 271. This model is used to analyze the compaction and sintering of cemented carbides and the model is based on the works of Brandt (1998). This material is only available for solid elements.

Card 1	1	2	3	4	5	6	7	8
Variable	MID	R0	P11	P22	P33	P12	P23	P13
Type	A8	F	F	F	F	F	F	F
Default	none	none	none	none	none	none	none	none

Card 2	1	2	3	4	5	6	7	8
Variable	E0	LCK	PR	LCX	LCY	LCC	L	R
Type	F	F	F	F	F	F	F	F
Default	none	none	none	none	none	none	none	none

Card 3	1	2	3	4	5	6	7	8
Variable	CA	CD	CV	P	LCH	LCFI	SINT	TZRO
Type	F	F	F	F	F	F	F	F
Default	none	none	none	none	none	none	0.0	none

Sintering Card 1. Additional card for SINT = 1.

Card 4	1	2	3	4	5	6	7	8
Variable	LCFK	LCFS2	DV1	DV2	DS1	DS2	OMEGA	RGAS
Type	F	F	F	F	F	F	F	F
Default	none	none	none	none	none	none	none	none

Sintering Card 2. Additional card for SINT = 1.

Card 5	1	2	3	4	5	6	7	8
Variable	LCPR	LCFS3	LCTAU	ALPHA	LCFS1	GAMMA	L0	LCFKS
Type	F	F	F	F	F	F	F	F
Default	none	none	none	none	none	none	none	none

VARIABLE**DESCRIPTION**

MID	Material identification. A unique number or label not exceeding 8 characters must be specified.
RO	Mass density.
PIJ	Initial compactness tensor P_{ij}
E0	Initial anisotropy variable e (value between 1 and 2)
LCK	Load curve for bulk modulus K as function of relative density d
PR	Poisson's ratio
LCX	Load curve for hydrostatic compressive yield X as function of relative density d
LCY	Load curve for uniaxial compressive yield Y as function of relative density d
LCC	Load curve for shear yield C_0 as function of relative density d

L	Yield surface parameter L relating hydrostatic compressive yield to point on hydrostatic axis with maximum strength
R	Yield surface parameter R governing the shape of the yield surface
CA	Hardening parameter c_a
CD	Hardening parameter c_d
CV	Hardening parameter c_v
P	Hardening exponent p
LCH	Load curve giving back stress parameter H as function of hardening parameter e .
LCFI	Load curve giving plastic strain evolution angle ϕ as function of relative volumetric stress.
SINT	Activate sintering EQ.0.0: Sintering off EQ.1.0: Sintering on
TZRO	Absolute zero temperature T_0
LCFK	Load curve f_K for viscous compliance as function of relative density d
LCFS2	Load curve f_{S2} for viscous compliance as function of temperature T
DV1	Volume diffusion coefficient $dV1$
DV2	Volume diffusion coefficient $dV2$
DS1	Surface diffusion coefficient $dS1$
DS2	Surface diffusion coefficient $dS2$
OMEGA	Blending parameter ω
RGAS	Universal gas constant R_{gas}
LCPR	Load curve for viscous Poisson's ratio ν as function of relative density d

LCFS3	Load curve fS3 for evolution of mobility factor as function of temperature T
LCTAU	Load curve for relaxation time τ as function of temperature T
ALPHA	Thermal expansion coefficient α
LCFS1	Load curve fS1 for sintering stress scaling as function of relative density d
GAMMA	Surface energy density γ affecting sintering stress
L0	Grain size l0 affecting sintering stress
LCFKS	Load curve fKS scaling bulk modulus as function of temperature T

Remarks:

This model is intended to be used in two stages. During the first step the compaction of a powder specimen is simulated after which the results are dumped to file, and in a subsequent step the model is restarted for simulating sintering of the compacted specimen. In the following, an overview of the two different models is given, for a detailed description we refer to Brandt (1998). The progressive stiffening in the material during compaction makes it more or less necessary to run double precision and with constraint contacts to avoid instabilities, unfortunately this currently limitates the use of this material to the smp version of LS-DYNA.

The powder compaction model makes use of a multiplicative split of the deformation gradient into a plastic and elastic part according to

$$\mathbf{F} = \mathbf{F}_e \mathbf{F}_p$$

where the plastic deformation gradient maps the initial reference configuration to an intermediate relaxed configuration

$$\delta \tilde{\mathbf{x}} = \mathbf{F}_p \delta \mathbf{X}$$

and subsequently the elastic part maps this onto the current loaded configuration

$$\delta \mathbf{x} = \mathbf{F}_e \delta \tilde{\mathbf{x}}$$

The compactness tensor is introduced that maps the intermediate configuration onto a virtual fully compacted configuration

$$\delta \bar{\mathbf{x}} = \mathbf{P} \delta \tilde{\mathbf{x}}$$

and we define the relative density as

$$d = \det \mathbf{P} = \frac{\rho}{\bar{\rho}}$$

where ρ and $\bar{\rho}$ denotes the current and fully compacted density, respectively. The elastic properties depend highly on the relative density through the bulk modulus $K(d)$ but the Poisson's ratio is assumed constant.

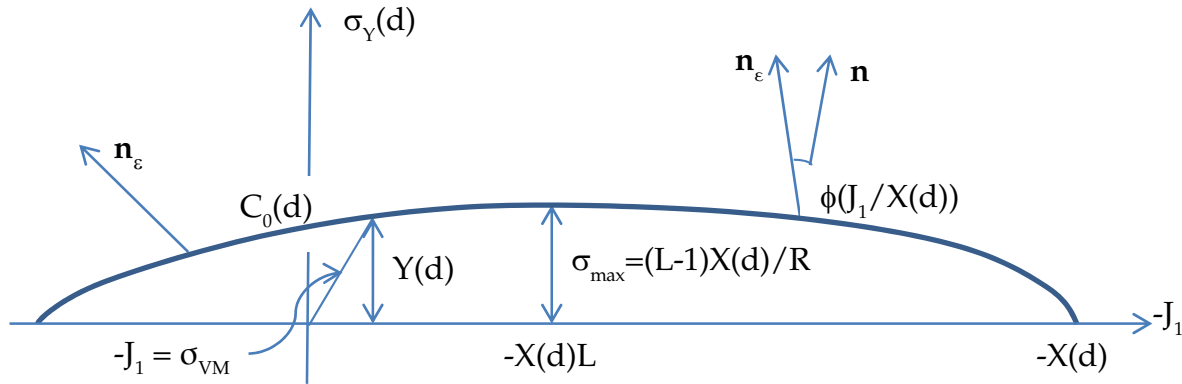

The yield surface is represented by two functions in the Rendulic plane according to

$$\sigma_Y(d) = \begin{cases} C_0(d) - C_1(d)J_1 - C_2(d)J_1^2 & J_1 \geq LX(d) \\ \frac{\sqrt{[(L-1)X(d)]^2 - [J_1 - LX(d)]^2}}{R} & J_1 < LX(d) \end{cases}$$

and is in this way capped in both compression and tension, here

$$J_1 = 3\sigma^m = Tr(\sigma).$$

The polynomial coefficients in the expression above are chosen to give continuity at $J_1 = LX(d)$ and to give the uniaxial compressive strength $Y(d)$. Yielding is assumed to occur when the equivalent stress (note the definition) equals the yield stress

$$\sigma_{eq} = \frac{\sigma_{VM}}{\sqrt{3}} = \sqrt{\frac{1}{2} \mathbf{s} : \mathbf{s}} \leq \sigma_Y(d)$$

where

$$\mathbf{s} = \underbrace{\boldsymbol{\sigma} - \sigma^m \mathbf{I}}_{\sigma^d} - \boldsymbol{\kappa}$$

in which the last term is the back stress to be dealt with below. The yield surface does not depend on the third stress invariant. The plastic flow is non-associated and its direction is given by

$$\mathbf{n}_\epsilon = \begin{pmatrix} \cos\phi & -\sin\phi \\ \sin\phi & \cos\phi \end{pmatrix} \mathbf{n}$$

where

$$\mathbf{n} = \frac{\sigma_Y(d)}{\sigma_{max}} \begin{pmatrix} \frac{\partial \sigma_Y}{\partial J_1} \\ 1 \end{pmatrix}$$

is the normal to the yield surface as depicted in the Rendulic plane above (note the sign of J_1). The angle ϕ is a function of and defined only for positive values of the relative volumet-

ric stress $J_1/X(d) > 0$, for negative values ϕ is determined internally to achieve smoothness in the plastic flow direction and such that avoid numerical problems at the tensile cap point. The above equations are for illustrative purposes, from now on the plastic flow direction is generalized to a second order tensor. The plastic flow rule is then

$$\dot{\boldsymbol{\epsilon}}_p = \dot{\lambda} \mathbf{n}_\epsilon, \quad \dot{\epsilon}_p^m = \frac{1}{3} \text{Tr}(\dot{\boldsymbol{\epsilon}}_p), \quad \dot{\boldsymbol{\epsilon}}_p^d = \dot{\boldsymbol{\epsilon}}_p - \dot{\epsilon}_p^m \mathbf{I}$$

The evolution of the compactness tensor is directly related to the evolution of plastic strain as

$$\dot{\mathbf{P}} = -\frac{1}{2} (\dot{\boldsymbol{\epsilon}}_p \mathbf{P} + \mathbf{P} \dot{\boldsymbol{\epsilon}}_p)$$

and thus the relative density is given by

$$\dot{d} = -3\dot{\epsilon}_p^m d.$$

The back stress is assumed coaxial with the deviatoric part of the compactness tensor and given by

$$\boldsymbol{\kappa} = J_1 H(e) \left(\mathbf{P} - \frac{\text{Tr}(\mathbf{P})}{3} \mathbf{I} \right)$$

where e is a measure of intensity of anisotropy. This takes a value between 1 and 2 and evolves with plastic strain and plastic work according to

$$\dot{e} = c_a \sqrt{\frac{1}{2} \dot{\boldsymbol{\epsilon}}_p^d : \dot{\boldsymbol{\epsilon}}_p^d} - c_v J_1 \dot{\epsilon}_p^m W(d, J_1) + c_d \dot{\boldsymbol{\epsilon}}_p^d : \boldsymbol{\sigma} W(d, J_1)$$

where

$$W(d, J_1) = - \left[\frac{J_1}{X(d)} \right]^p \int_{d_0}^d \frac{X(\xi)}{3\xi} d\xi$$

and d_0 is the density in the initial uncompressed configuration. The stress update is completed by the rate equation of stress

$$\dot{\boldsymbol{\sigma}} = \mathbf{C}(d) : (\dot{\boldsymbol{\epsilon}} - \dot{\boldsymbol{\epsilon}}_p)$$

where $\mathbf{C}(d)$ is the elastic constitutive matrix.

The sintering model is a thermo and viscoelastic model where the evolution of the mean and deviatoric stress can be written as

$$\begin{aligned} \dot{\sigma}^m &= 3K^s (\dot{\epsilon}^m - \dot{\epsilon}_T - \dot{\epsilon}_p^m) \\ \dot{\sigma}^d &= 2G^s (\dot{\boldsymbol{\epsilon}}^d - \dot{\boldsymbol{\epsilon}}_p^d) \end{aligned}$$

The thermal strain rate is given by the thermal expansion coefficient as

$$\dot{\epsilon}_T = \alpha \dot{T}$$

and the bulk and shear modulus are the same as for the compaction model with the exception that they are scaled by a temperature curve

$$K^s = f_{KS}(T)K(d)$$

$$G^s = \frac{3(1 - 2\nu)}{2(1 + \nu)}K^s$$

The inelastic strain rates are different from the compaction model and is here given by

$$\dot{\epsilon}_p = \frac{\sigma^d}{2G^v} + \frac{\sigma^m - \sigma^s}{3K^v}\mathbf{I}$$

which results in a viscoelastic behavior depending on the viscous compliance and sintering stress. The viscous bulk compliance can be written

$$\frac{1}{K^v} = 3f_K(d) \left\{ d_{V1} \exp \left[-\frac{d_{V2}}{R_{gas}(T - T_0)} \right] + \omega d_{S1} \exp \left[-\frac{d_{S2}}{R_{gas}(T - T_0)} \right] \right\} [1 + f_{S2}(T)\xi]$$

from which the viscous shear compliance is modified with aid of the viscous Poisson's ratio

$$\frac{1}{G^v} = \frac{2[1 + \nu^v(d)]}{3[1 - 2\nu^v(d)]} \frac{1}{K^v}.$$

The mobility factor ξ evolves with temperature according to

$$\dot{\xi} = \frac{f_{S3}(T)\dot{T} - \xi}{\tau(T)}$$

and the sintering stress is given as

$$\sigma^s = f_{S1}(d) \frac{\gamma}{l_0}.$$

All this is accompanied with, again, the evolution of relative density given as

$$\dot{d} = -3\dot{\epsilon}_p^m d$$

***MAT_RHT**

This is material type 272. This model is used to analyze concrete structures subjected to impulsive loadings, see Riedel et.al. (1999) and Riedel (2004).

Card 1	1	2	3	4	5	6	7	8
Variable	MID	RO	SHEAR	ONEMPA	EPSF	B0	B1	T1
Type	A8	F	F	F	F	F	F	F
Default	none	none	none	1.0	2.0	none	none	none

Card 2	1	2	3	4	5	6	7	8
Variable	A	N	FC	FS*	FT*	Q0	B	T2
Type	F	F	F	F	F	F	F	F
Default	none	none	none	none	none	none	none	none

Card 3	1	2	3	4	5	6	7	8
Variable	E0C	E0T	EC	ET	BETAC	BETAT	PTF	
Type	F	F	F	F	F	F	F	
Default	none	none	none	none	See remarks	See remarks	0.001	

Card 4	1	2	3	4	5	6	7	8
Variable	GC*	GT*	XI	D1	D2	EPM	AF	NF
Type	F	F	F	F	F	F	F	F
Default	none	none	none	none	none	none	none	none

Card 5	1	2	3	4	5	6	7	8
Variable	GAMMA	A1	A2	A3	PEL	PCO	NP	ALPHA0
Type	F	F	F	F	F	F	F	F
Default	none	none	none	none	none	none	none	none

VARIABLE

DESCRIPTION

MID	Material identification. A unique number or label not exceeding 8 characters must be specified.
RO	Mass density.
SHEAR	Elastic shear modulus
ONEMPA	Unit conversion factor defining 1 Mpa in the pressure units used. It can also be used for automatic generation of material parameters for a given compressive strength. (See remarks) EQ.0: Defaults to 1.0 EQ.-1: Parameters generated in m, s and kg (Pa) EQ.-2: Parameters generated in mm, s and tonne (MPa) EQ.-3: Parameters generated in mm, ms and kg (GPa) EQ.-4: Parameters generated in in, s and dozens of slugs (psi) EQ.-5: Parameters generated in mm, ms and g (MPa) EQ.-6: Parameters generated in cm, μ s and g (Mbar) EQ.-7: Parameters generated in mm, ms and mg (kPa)

EPSF	Eroding plastic strain
B0	Parameter for polynomial EOS
B1	Parameter for polynomial EOS
T1	Parameter for polynomial EOS
A	Failure surface parameter A
N	Failure surface parameter N
FC	Compressive strength.
FS*	Relative shear strength
FT*	Relative tensile strength
Q0	Lode angle dependence factor
B	Lode angle dependence factor
T2	Parameter for polynomial EOS
E0C	Reference compressive strain rate
E0T	Reference tensile strain rate
EC	Break compressive strain rate
ET	Break tensile strain rate
BETAC	Compressive strain rate dependence exponent (optional)
BETAT	Tensile strain rate dependence exponent (optional)
PTF	Pressure influence on plastic flow in tension
GC*	Compressive yield surface parameter
GT*	Tensile yield surface parameter
XI	Shear modulus reduction factor
D1	Damage parameter
D2	Damage parameter

EPM	Minimum damaged residual strain
AF	Residual surface parameter
NF	Residual surface parameter
GAMMA	Gruneisen gamma
A1	Hugoniot polynomial coefficient
A2	Hugoniot polynomial coefficient
A3	Hugoniot polynomial coefficient
PEL	Crush pressure
PCO	Compaction pressure
NP	Porosity exponent
ALPHA	Initial porosity

Remarks:

In the RHT model, the shear and pressure part is coupled in which the pressure is described by the Mie-Gruneisen form with a polynomial Hugoniot curve and a p- α compaction relation. For the compaction model, we define a history variable representing the porosity α that is initialized to $\alpha_0 > 1$. This variable represents the current fraction of density between the matrix material and the porous concrete and will decrease with increasing pressure, i.e., the reference density is expressed as $\alpha\rho$. The evolution of this variable is given as

$$\alpha(t) = \max \left(1, \min \left\{ \alpha_0, \min_{s \leq t} \left[1 + (\alpha_0 - 1) \left(\frac{p_{\text{comp}} - p(s)}{p_{\text{comp}} - p_{\text{el}}} \right)^N \right] \right\} \right)$$

where $p(t)$ indicates the pressure at time t . This expression also involves the initial pore crush pressure p_{el} , compaction pressure p_{comp} and porosity exponent N . For later use, we define the cap pressure, or current pore crush pressure, as

$$p_c = p_{\text{comp}} - (p_{\text{comp}} - p_{\text{el}}) \left[\frac{\alpha - 1}{\alpha_0 - 1} \right]^{1/N}$$

The remainder of the pressure (EOS) model is given in terms of the porous density ρ and specific internal energy e (wrt the porous density). Depending on user inputs, it is either governed by ($B_0 > 0$)

$$p(\rho, e) = \frac{1}{\alpha} \begin{cases} (B_0 + B_1\eta)\alpha\rho e + A_1\eta + A_2\eta^2 + A_3\eta^3 & \eta > 0 \\ B_0\alpha\rho e + T_1\eta + T_2\eta^2 & \eta < 0 \end{cases}$$

or ($B_0 = 0$)

$$p(\rho, e) = \Gamma\rho e + \frac{1}{\alpha} p_H(\eta) \left[1 - \frac{1}{2}\Gamma\eta \right]$$

$$p_H(\eta) = A_1\eta + A_2\eta^2 + A_3\eta^3$$

together with

$$\eta(\rho) = \frac{\alpha\rho}{\alpha_0\rho_0} - 1.$$

For the shear strength description we use

$$p^* = \frac{p}{f_c}$$

as the pressure normalized with the compressive strength parameter. We also use \mathbf{s} to denote the deviatoric stress tensor and $\dot{\varepsilon}_p$ the plastic strain rate.

For a given stress state and rate of loading, the elastic-plastic yield surface for the RHT model is given by

$$\sigma_y(p^*, \mathbf{s}, \dot{\varepsilon}_p, \varepsilon_p^*) = f_c \sigma_y^*(p^*, F_r(\dot{\varepsilon}_p, p^*), \varepsilon_p^*) R_3(\theta, p^*)$$

and is the composition of two functions and the compressive strength parameter f_c . The first describes the pressure dependence for principal stress conditions $\sigma_1 < \sigma_2 = \sigma_3$ and is expressed in terms of a failure surface and normalized plastic strain as

$$\sigma_y^*(p^*, F_r, \varepsilon_p^*) = \sigma_f^* \left(\frac{p^*}{\gamma}, F_r \right) \gamma$$

with

$$\gamma = \varepsilon_p^* + (1 - \varepsilon_p^*) F_e F_c .$$

The failure surface is given as

$$\sigma_f^*(p^*, F_r) = \begin{cases} A(p^* - F_r/3 + (A/F_r)^{-1/n})^n & 3p^* \geq F_r \\ F_r f_s^* / Q_1 + 3p^*(1 - f_s^* / Q_1) & F_r > 3p^* \geq 0 \\ F_r f_s^* / Q_1 - 3p^*(1/Q_2 - \frac{f_s^*}{Q_1 f_t^*}) & 0 > 3p^* \geq 3p_t^* \\ 0 & 3p_t^* > 3p^* \end{cases}$$

in which $p_t^* = \frac{F_r Q_2 f_s^* f_t^*}{3(Q_1 f_t^* - Q_2 f_s^*)}$ is the failure cut-off pressure, F_r is a dynamic increment factor and

$$Q_1 = R_3(\pi/6, 0) \quad Q_2 = Q(p^*)$$

In these expressions, f_t^* and f_s^* are the tensile and shear strength of the concrete relative to the compressive strength f_c and the Q values are introduced to account for the tensile and shear meridian dependence. Further details are given in the following.

To describe reduced strength on shear and tensile meridian the factor

$$R_3(\theta, p^*) = \frac{2(1 - Q^2)\cos\theta + (2Q - 1)\sqrt{4(1 - Q^2)\cos^2\theta + 5Q^2 - 4Q}}{4(1 - Q^2)\cos^2\theta + (1 - 2Q)^2}$$

is introduced, where θ is the Lode angle given by the deviatoric stress tensor \mathbf{s} as

$$\cos 3\theta = \frac{27\det(\mathbf{s})}{2\bar{\sigma}(\mathbf{s})^3} \bar{\sigma}(\mathbf{s}) = \sqrt{\frac{3}{2} \mathbf{s} : \mathbf{s}} .$$

The maximum reduction in strength is given as a function of relative pressure

$$Q = Q(p^*) = Q_0 + Bp^* .$$

Finally, the strain rate dependence is given by

$$F_r(\dot{\epsilon}_p, p^*) = \begin{cases} F_r^c & 3p^* \geq F_r^c \\ F_r^c - \frac{3p^* - F_r^c}{F_r^c + F_r^t f_t^*} (F_r^t - F_r^c) & F_r^c > 3p^* \geq -F_r^t f_t^* \\ F_r^t & -F_r^t f_t^* > 3p^* \end{cases}$$

in which

$$F_r^t(\dot{\epsilon}_p) = \begin{cases} \left(\frac{\dot{\epsilon}_p}{\dot{\epsilon}_0^t} \right)^{\beta_c} & \dot{\epsilon}_p \leq \dot{\epsilon}_p^t \\ \gamma_c^t \sqrt[3]{\dot{\epsilon}_p} & \dot{\epsilon}_p > \dot{\epsilon}_p^t \end{cases} .$$

The parameters involved in these expressions are given as (f_c is in MPa below)

$$\beta_c = \frac{4}{20 + 3f_c} \beta_t = \frac{2}{20 + f_c}$$

and $\gamma_{c/t}$ is determined from continuity requirements, but it is also possible to choose the rate parameters via inputs.

The elastic strength parameter used above is given by

$$F_e(p^*) = \begin{cases} g_c^* & 3p^* \geq F_r^c g_c^* \\ g_c^* - \frac{3p^* - F_r^c g_c^*}{F_r^c g_c^* + F_r^t g_t^* f_t^*} (g_t^* - g_c^*) & F_r^c g_c^* > 3p^* \geq -F_r^t g_t^* f_t^* \\ g_t^* & -F_r^t g_t^* f_t^* > 3p^* \end{cases}$$

while the cap of the yield surface is represented by

$$F_c(p^*) = \begin{cases} 0 & p^* \geq p_c^* \\ \sqrt{1 - \left(\frac{p^* - p_u^*}{p_c^* - p_u^*}\right)^2} & p_c^* > p^* \geq p_u^* \\ 1 & p_u^* > p^* \end{cases}$$

where

$$p_c^* = \frac{p_c}{f_c} p_u^* = \frac{F_r^c g_c^*}{3} + \frac{G^* \varepsilon_p}{f_c}$$

The hardening behavior is described linearly with respect to the plastic strain, where

$$\varepsilon_p^* = \min\left(\frac{\varepsilon_p}{\varepsilon_p^h}, 1\right) \varepsilon_p^h = \frac{\sigma_y(p^*, \mathbf{s}, \dot{\varepsilon}_p, \varepsilon_p^*) (1 - F_e F_c)}{\gamma 3 G^*}$$

here

$$G^* = \zeta G$$

where G is the shear modulus of the virgin material and ζ is a reduction factor representing the hardening in the model.

When hardening states reach the ultimate strength of the concrete on the failure surface, damage is accumulated during further inelastic loading controlled by plastic strain. To this end, the plastic strain at failure is given as

$$\varepsilon_p^f = \begin{cases} D_1 [p^* - (1 - D)p_t^*]^{D_2} & p^* \geq (1 - D)p_t^* + \left(\frac{\varepsilon_p^m}{D_1}\right)^{1/D_2} \\ \varepsilon_p^m & (1 - D)p_t^* + \left(\frac{\varepsilon_p^m}{D_1}\right)^{1/D_2} > p^* \end{cases}$$

The damage parameter is accumulated with plastic strain according to

$$D = \int_{\varepsilon_p^h}^{\varepsilon_p} \frac{d\varepsilon_p}{\varepsilon_p}$$

and the resulting damage surface is given as

$$\sigma_d(p^*, \mathbf{s}, \dot{\varepsilon}_p) = \begin{cases} \sigma_y(p^*, \mathbf{s}, \dot{\varepsilon}_p, 1)(1 - D) + D f_c \sigma_r^*(p^*) & p^* \geq 0 \\ \sigma_y(p^*, \mathbf{s}, \dot{\varepsilon}_p, 1)(1 - D - \frac{p^*}{p_t^*}) & (1 - D)p_t^* \leq p^* < 0 \end{cases}$$

where

$$\sigma_r^*(p^*) = A_f(p^*)^{n_f}$$

Plastic flow occurs in the direction of deviatoric stress, i.e.,

$$\dot{\epsilon}_p \sim \mathbf{s}$$

but for tension there is an option to set the parameter PFC to a number corresponding to the influence of plastic volumetric strain. If $\lambda \leq 1$ is used to denote this parameter, then for the special case of $\lambda = 1$

$$\dot{\epsilon}_p \sim \mathbf{s} - p\mathbf{I}$$

This was introduced to reduce noise in tension that was observed on some test problems. A failure strain can be used to erode elements with severe deformation which by default is set to 200%.

For simplicity, automatic generation of material parameters is available via ONEMPA.LT.0, then no other parameters are needed. If FC.EQ.0 then the 35 MPa strength concrete in Riedel (2004) is generated in the units specified by the value of ONEMPA. For FC.GT.0 then FC specifies the actual strength of the concrete in the units specified by the value of ONEMPA. The other parameters are generated by interpolating between the 35 MPa and 140 MPa strength concretes as presented in Riedel (2004). Any automatically generated parameter may be overridden by the user if motivated, one of these parameters may be the initial porosity ALPHA0 of the concrete.

For post-processing, the following history variables may be of interest

- History variable #2 Internal energy per volume (ρe)
- History variable #3 Porosity value (α)
- History variable #4 Damage value (D)

MAT_CONCRETE_DAMAGE_PLASTIC_MODEL**MAT_CDPM**

This is material type 273. This is a damage plastic concrete model based on work published in Grassl et al. (2011) and Grassl and Jirasek (2006). This model is aimed to simulations where failure of concrete structures subjected to dynamic loadings is sought. It describes the characterization of the failure process subjected to multi-axial and rate-dependent loading. The model is based on effective stress plasticity and with a damage model based on both plastic and elastic strain measures. This material model is available only for solids.

There are a lot of parameters for the advanced user but note that most of them have default values that are based on experimental tests. They might not be useful for all types of concrete and all types of load paths but they are values that can be used as a good starting point. If the default values is not good enough the theory chapter at the end of the parameter description can be of value.

History variables that can be exported to the database are:

- 1 – damage function in tension
- 2 – damage function in compression
- 3 – number of integration points in element that have failed

Card 1	1	2	3	4	5	6	7	8
Variable	MID	R0	E	PR	ECC	QH0	FT	FC
Type	A8	F	F	F	F	F	F	F
Default	none	none	none	0.2	AUTO	0.3	none	none

Card 2	1	2	3	4	5	6	7	8
Variable	HP	AH	BH	CH	DH	AS	DF	FC0
Type	F	F	F	F	F	F	F	F
Default	0.5	0.08	0.003	2.0	1.0E-6	15.0	0.85	10.0

Card 3	1	2	3	4	5	6	7	8
Variable	TYPE	BS	WF	WF1	FT1	STRFLG	FAILFLG	
Type	F	F	F	F	F	F	F	
Default	0.0	1.0	none	0.15*WF	0.3*FT	0.0	0.0	

VARIABLE

DESCRIPTION

MID Material identification. A unique number or label not exceeding 8 characters must be specified.

RO Mass density.

E Youngs modulus

PR Poissons ratio

ECC Eccentricity parameter.

EQ.0.0: ECC is calculated from Jirazek and Bazant (2002) as

$$ECC = \frac{1 + \epsilon}{1 - \epsilon}, \quad \epsilon = \frac{f_t(f_{bc}^2 - f_c^2)}{f_{bc}(f_c^2 - f_t^2)}, \quad f_{bc} = 1.16f_c$$

QH0 Initial hardening defined as FC₀/FC where FC₀ is the compressive stress at which the initial yield surface is reached. Default = 0.3

FT Uniaxial tensile strength (stress)

FC Uniaxial compression strength (stress)

HP Hardening parameter.
Must be HP < 1.0 - QH0

AH Hardening ductility parameter 1

BH Hardening ductility parameter 2

CH Hardening ductility parameter 3

DH Hardening ductility parameter 4

AS Ductility parameter during damage

DF	Flow rule parameter
FC0	Rate dependent parameter
TYPE	Flag for damage type. EQ.0.0: Linear damage formulation (Default) EQ.1.0: Bi-linear damage formulation EQ.2.0: No damage
BS	Damage ductility exponent during damage. Default = 1.0
WF	Tensile threshold value for linear damage formulation
WF1	Tensile threshold value for the second part of the bi-linear damage formulation. Default = $0.15 \times WF$
FT1	Tensile strength threshold value for bi-linear damage formulation. Default = $0.3 \times FT$
STRFLG	Strain rate flag. EQ.1.0: Strain rate dependent EQ.0.0: No strain rate dependency.
FAILFLG	Failure flag. EQ.0.0: Not active \Rightarrow No erosion. GT.0.0: Active and element will erode if w_t and w_c is equal to 1 in FAILFLG percent of the integration points. If FAILFLG = 0.60, 60% of all integration points must fail before erosion.

Remarks:

The stress for the damage plasticity model is defined as

$$\sigma = (1 - w_t)\sigma_t + (1 - w_c)\sigma_c$$

where σ_t and σ_c are the positive and negative part of the effective stress. The scalar functions w_t and w_c are damage parameters.

Plasticity:

The yield surface is described by the Haigh-Westergaard coordinates: the volumetric effective stress σ_v , the norm of the deviatoric effective stress ρ and the Lode angle θ , and it is given by

$$f_p(\sigma_v, \rho, \theta, \kappa) = \left[[1 - q_1(\kappa)] \left(\frac{\rho}{\sqrt{6}f_c} + \frac{\sigma_v}{f_c} \right)^2 + \sqrt{\frac{3}{2}} \frac{\rho}{f_c} \right]^2 + m_0 q_1(\kappa) q_2(\kappa) \left[\frac{\rho}{\sqrt{6}f_c} r(\cos \theta) + \frac{\sigma_v}{f_c} \right] - q_1^2(\kappa) q_2^2(\kappa).$$

The variables q_1 and q_2 are dependent on the hardening variable κ . The parameter f_c is the uniaxial compressive strength. The shape of the deviatoric section is controlled by the function

$$r(\cos \theta) = \frac{4(1 - e^2) \cos^2 \theta + (2e - 1)^2}{2(1 - e^2) \cos^2 \theta + (2e - 1) \sqrt{4(1 - e^2) \cos^2 \theta + 5e^2 - 4e}}$$

where e is the eccentricity parameter (ECC). The parameter m_0 is the friction parameter and it is defined as

$$m_0 = \frac{3(f_c^2 - f_t^2)}{f_c f_t} \frac{e}{e + 1}$$

where f_t is the tensile strength.

The flow rule is non-associative which means that the direction of the plastic flow is not normal to the yield surface. This is important for concrete since an associative flow rule would give an overestimated maximum stress. The plastic potential is given by

$$g(\sigma_v, \rho, \kappa) = \left\{ [1 - q_1(\kappa)] \left(\frac{\rho}{\sqrt{6}f_c} + \frac{\sigma_v}{f_c} \right)^2 + \sqrt{\frac{3}{2}} \frac{\rho}{f_c} \right\}^2 + q_1(\kappa) q_2(\kappa) \left(\frac{m_0 \rho}{\sqrt{6}f_c} + \frac{m_g(\sigma_v, \kappa)}{f_c} \right)$$

where

$$m_g(\sigma_v, \kappa) = A_g(\kappa) B_g(\kappa) f_c e^{\frac{\sigma_v - q_2 f_t / 3}{B_g f_c}}$$

and

$$A_g = \frac{3f_t q_2(\kappa)}{f_c} + \frac{m_0}{2}, \quad B_g = \frac{q_2(\kappa)}{3} \frac{1 + f_t / f_c}{\ln \frac{A_g}{3q_2 + \frac{m_0}{2}} + \ln \left(\frac{D_f + 1}{2D_f - 1} \right)}$$

The hardening laws q_1 and q_2 control the shape of the yield surface and the plastic potential, and they are defined as

$$q_1(\kappa) = q_{h0} + (1 - q_{h0})(\kappa^3 - 3\kappa^2 + 3\kappa) - H_p(\kappa^3 - 3\kappa^2 + 2\kappa), \quad \kappa < 1$$

$$\begin{aligned}
 q_1(\kappa) &= 1, & \kappa &\geq 1 \\
 q_2(\kappa) &= 1, & \kappa &< 1 \\
 q_2(\kappa) &= 1 + H_p(\kappa - 1), & \kappa &\geq 1
 \end{aligned}$$

The evolution for the hardening variable is given by

$$\dot{\kappa} = \frac{4\dot{\lambda} \cos^2 \theta}{x_h(\sigma_v)} \left\| \frac{dg}{d\sigma} \right\|$$

It sets the rate of the hardening variable to the norm of the plastic strain rate scaled by a ductility measure which is defined below as

$$\begin{aligned}
 x_h(\sigma_v) &= A_h - (A_h - B_h)e^{-\frac{R_h}{C_h}}, & R_h &\geq 0 \\
 x_h(\sigma_v) &= E_h e^{\frac{R_h}{F_h}} + D_h, & R_h &< 0
 \end{aligned}$$

And finally

$$E_h = B_h - D_h, \quad F_h = \frac{(B_h - D_h)C_h}{A_h - B_h}$$

Damage:

Damage is initialized when the equivalent strain reaches $\tilde{\varepsilon}$ the threshold value $\varepsilon_0 = f_t/E$ where the equivalent strain is defined as

$$\tilde{\varepsilon} = \frac{\varepsilon_0 m_0}{2} \left[\frac{\rho}{\sqrt{6}f_c} r(\cos\theta) + \frac{\sigma_V}{f_c} + \sqrt{\frac{\varepsilon_0^2 m_0^2}{4} \left(\frac{\rho}{\sqrt{6}f_c} r(\cos\theta) + \frac{\sigma_V}{f_c} \right)^2 + \frac{3\varepsilon_0^2 \rho^2}{2f_c^2}} \right]$$

For linear damage type the stress value f_t and the failure strain w_f must be defined and for the bi-linear type two additional parameters must be defined, see figure below how the stress softening is controlled by the input parameters.

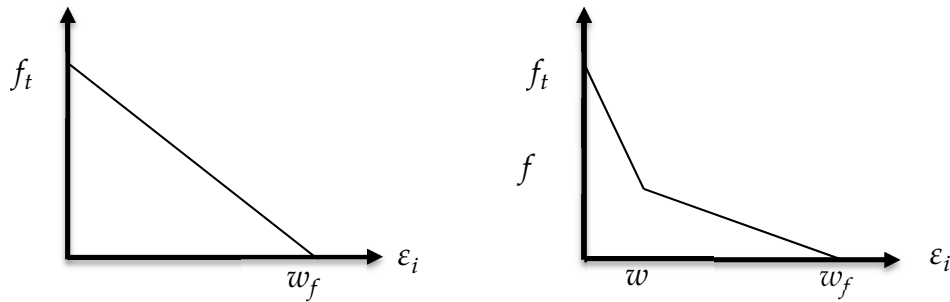

The variable ε_i is called the inelastic strain and is defined as the sum of the irreversible plastic strain ε_p and the reversible strain $w_t(\varepsilon - \varepsilon_p)$ (in compression $w_c(\varepsilon - \varepsilon_p)$). To get the

influence of multi-axial stress states on the softening a damage ductility measure x_s is added:

$$x_s = 1 + (A_s - 1)R_s^{B_s}$$

Where A_s and B_s are input parameters, and

$$R_s = -\frac{\sqrt{6}\sigma_v}{\rho}, \quad \sigma_v < 0 \text{ and } R_s = 0, \quad \sigma_v > 0$$

The inelastic strain is then modified according:

$$\varepsilon_i = \frac{\varepsilon_i}{x_s}$$

Strain rate:

Concrete is strongly rate dependent. If the loading rate is increased, the tensile and compressive strength increase and are more prominent in tension than in compression. The dependency is taken into account by an additional variable $\alpha_r \geq 1$. The rate dependency is included by scaling both the equivalent strain rate and the inelastic strain. The rate parameter is defined by

$$\alpha_r = (1 - X_{\text{compression}}) \alpha_{rt} + X_{\text{compression}} \alpha_{rc}$$

Where X is continuous compression measure (= 1 means only compression, = 0 means only tension) and for tension we have

$$\alpha_{rt} = \begin{cases} 1 & \dot{\varepsilon}_{\max} < 30 \times 10^{-6} s^{-1} \\ \left(\frac{\dot{\varepsilon}_{\max}}{\dot{\varepsilon}_{t0}}\right)^{\delta_t} & 30 \times 10^{-6} < \dot{\varepsilon}_{\max} < 1 s^{-1} \\ \beta_t \left(\frac{\dot{\varepsilon}_{\max}}{\dot{\varepsilon}_{t0}}\right)^{\frac{1}{3}} & \dot{\varepsilon}_{\max} > 1 s^{-1} \end{cases}$$

where $\delta_t = \frac{1}{1+8f_c/f_{c0}}$, $\beta_t = e^{6\delta_t-2}$ and $\dot{\varepsilon}_{t0} = 1 \times 10^{-6} s^{-1}$. For compression the corresponding rate factor is given by

$$\alpha_{rc} = \begin{cases} 1 & |\dot{\varepsilon}_{\min}| < 30 \times 10^{-6} s^{-1} \\ \left[S \frac{|\dot{\varepsilon}_{\min}|}{\dot{\varepsilon}_{c0}}\right]^{1.026\delta_c} & 30 \times 10^{-6} < |\dot{\varepsilon}_{\min}| < 1 s^{-1} \\ \beta_c \left[\frac{|\dot{\varepsilon}_{\min}|}{\dot{\varepsilon}_{c0}}\right]^{\frac{1}{3}} & |\dot{\varepsilon}_{\min}| > 30 s^{-1} \end{cases}$$

where $\delta_c = \frac{1}{5+9f_c/f_{c0}}$, $\beta_c = e^{6.156\delta_c-2}$ and $\dot{\varepsilon}_{c0} = 30 \times 10^{-6} s^{-1}$. The parameter f_{c0} is an input parameter that have a default value of 10.

***MAT_CHRONOLOGICAL_VISCOELASTIC**

This is Material Type 276. This material model provides a general viscoelastic Maxwell model having up to 6 terms in the prony series expansion and is useful for modeling dense continuum rubbers and solid explosives. It is similar to Material Type 76 but allows the incorporation of aging effects on the material properties. Either the coefficients of the prony series expansion or a relaxation curve may be specified to define the viscoelastic deviatoric and bulk behavior.

The material model can also be used with laminated shell. Either an elastic or viscoelastic layer can be defined with the laminated formulation. To activate laminated shell you need the laminated formulation flag on *CONTROL_SHELL. With the laminated option a user defined integration rule is needed.

Card 1	1	2	3	4	5	6	7	8
Variable	MID	RO	BULK	PCF	EF	TREF	A	B
Type	A8	F	F	F	F	F	F	F

If fitting is done from a relaxation curve, specify fitting parameters on card 2, *otherwise* if constants are set on Viscoelastic Constant Cards *LEAVE THIS CARD BLANK*.

Card 2	1	2	3	4	5	6	7	8
Variable	LCID	NT	BSTART	TRAMP	LCIDK	NTK	BSTARTK	TRAMPK
Type	F	I	F	F	F	I	F	F

Viscoelastic Constant Cards. Up to 12 cards may be input. A keyword card (with a "*" in column 1) terminates this input if less than 12 cards are used. These cards are not needed if relaxation data is defined. The number of terms for the shear behavior may differ from that for the bulk behavior: simply insert zero if a term is not included. If an elastic layer is defined you only need to define GI and KI (note in an elastic layer only one card is needed).

Optional	1	2	3	4	5	6	7	8
Variable	GI	BETAI	KI	BETAKI				
Type	F	F	F	F				

VARIABLE**DESCRIPTION**

MID	Material identification. A unique number or label not exceeding 8 characters must be specified.
RO	Mass density.
BULK	Elastic bulk modulus.
PCF	Tensile pressure elimination flag for solid elements only. If set to unity tensile pressures are set to zero.
EF	Elastic flag (if equal 1, the layer is elastic. If 0 the layer is viscoelastic).
TREF	Reference temperature for shift function (must be greater than zero).
A	Chronological coefficient $\alpha(t_a)$. See Remarks below.
B	Chronological coefficient $\beta(t_a)$. See Remarks below.
LCID	Load curve ID for deviatoric behavior if constants, G_i , and β_i are determined via a least squares fit. This relaxation curve is shown below.
NT	Number of terms in shear fit. If zero the default is 6. Fewer than NT terms will be used if the fit produces one or more negative shear moduli. Currently, the maximum number is set to 6.
BSTART	In the fit, β_1 is set to zero, β_2 is set to BSTART, β_3 is 10 times β_2 , β_4 is 10 times β_3 , and so on. If zero, BSTART is determined by an iterative trial and error scheme.

VARIABLE	DESCRIPTION
TRAMP	Optional ramp time for loading.
LCIDK	Load curve ID for bulk behavior if constants, K_i , and $\beta\kappa_i$ are determined via a least squares fit. This relaxation curve is shown below.
NTK	Number of terms desired in bulk fit. If zero the default is 6. Currently, the maximum number is set to 6.
BSTARTK	In the fit, $\beta\kappa_1$ is set to zero, $\beta\kappa_2$ is set to BSTARTK, $\beta\kappa_3$ is 10 times $\beta\kappa_2$, $\beta\kappa_4$ is 10 times $\beta\kappa_3$, and so on. If zero, BSTARTK is determined by an iterative trial and error scheme.
TRAMPK	Optional ramp time for bulk loading.
GI	Optional shear relaxation modulus for the <i>i</i> th term
BETAI	Optional shear decay constant for the <i>i</i> th term
KI	Optional bulk relaxation modulus for the <i>i</i> th term
BETAKI	Optional bulk decay constant for the <i>i</i> th term

Remarks:

The Cauchy stress, σ_{ij} , is related to the strain rate by

$$\sigma_{ij}(t) = -p\delta_{ij} + \int_0^t g_{ijkl}(t - \tau) \frac{\partial \varepsilon_{kl}(\tau)}{\partial \tau} d\tau$$

For this model, it is postulated that the mathematical form is preserved in the constitutive equation for aging; however two new material functions, $g'_0(t_a)$ and $g'_1(t_a, t)$ are introduced to replace g_0 and $g_1(t)$, which is expressed in terms of a Prony series as in material model 76, *MAT_GENERAL_VISCOELASTIC. The aging time is denoted by t_a .

$$\sigma_{ij}(t_a, t) = -p\delta_{ij} + \int_0^t g'_{ijkl}(t_a, t - \tau) \frac{\partial \varepsilon_{kl}(\tau)}{\partial \tau} d\tau$$

where

$$g'_{ijkl}(t_a, t) = \alpha(t_a)g_{ijkl}[\beta(t_a)t]$$

where $\alpha(t_a)$ and $\beta(t_a)$ are two new material properties that are functions of the aging time t_a . The material properties functions $\alpha(t_a)$ and $\beta(t_a)$ will be determined with the experimental results. For determination of $\alpha(t_a)$ and $\beta(t_a)$, Eq. (2) can be written in the following form

$$\log(\sigma_{ij} - p\delta_{ij})_{t_a, t} = \log\alpha(t_a) + \log(\sigma_{ij} - p\delta_{ij})_{t_a=0, t \rightarrow \xi}$$

$$\log \zeta = \log \beta(t_a) + \log t$$

Therefore, if one plots the stress versus time on log-log scales, with the vertical axis being the stress and the horizontal axis being the time, then the stress-relaxation curve for any aged time history can be obtained directly from the stress-relaxation curve at $t_a = 0$ by imposing a vertical shift and a horizontal shift on the stress-relaxation curves. The vertical shift and the horizontal shift are $\log \alpha(t_a)$ and $\log \beta(t_a)$ respectively.

***MAT_ALE_01**

***MAT_ALE_VACUUM**

***MAT_ALE_VACUUM**

See *MAT_VACUUM or *MAT_140.

*MAT_ALE_GAS_MIXTURE

This may also be referred to as *MAT_ALE_02. This model is used to simulate thermally equilibrated ideal gas mixtures. This only works with the multi-material ALE formulation (ELFORM = 11 in *SECTION_SOLID). This keyword needs to be used together with *INITIAL_GAS_MIXTURE for the initialization of gas densities and temperatures. When applied in the context of ALE airbag modeling, the injection of inflator gas is done with a *SECTION_POINT_SOURCE_MIXTURE command which controls the injection process. This is an identical material model to the *MAT_GAS_MIXTURE model.

Card 1	1	2	3	4	5	6	7	8
Variable	MID	IADIAB	RUNIV					
Type	A8	I	F					
Default	none	0	0.0					
Remark		5	1					

Card 2 for Per mass Calculation. Method (A) RUNIV = blank or 0.0.

Card 2	1	2	3	4	5	6	7	8
Variable	CVmass1	CVmass2	CVmass3	CVmass4	CVmass5	CVmass6	CVmass7	CVmass8
Type	F	F	F	F	F	F	F	F
Default	none	none	none	none	none	none	none	none

Card 3 for Per mass Calculation. Method (A) RUNIV = blank or 0.0.

Card 3	1	2	3	4	5	6	7	8
Variable	CPmass1	CPmass2	CPmass3	CPmass4	CPmass5	CPmass6	CPmass7	CPmass8
Type	F	F	F	F	F	F	F	F
Default	none	none	none	none	none	none	none	none

Card 2 for Per Mole Cclulation. Method (B) RUNIV is nonzero.

Card 2	1	2	3	4	5	6	7	8
Variable	MOLWT1	MOLWT2	MOLWT3	MOLWT4	MOLWT5	MOLWT6	MOLWT7	MOLWT8
Type	F	F	F	F	F	F	F	F
Default	none	none	none	none	none	none	none	none
Remark	2							

Card 3 for Per Mole Cclulation. Method (B) RUNIV is nonzero.

Card 3	1	2	3	4	5	6	7	8
Variable	CPmole1	CPmole2	CPmole3	CPmole4	CPmole5	CPmole6	Cpmole7	CPmole8
Type	F	F	F	F	F	F	F	F
Default	none	none	none	none	none	none	none	none
Remark	2							

Card 4 for Per Mole Cclulation. Method (B) RUNIV is nonzero.

Card 4	1	2	3	4	5	6	7	8
Variable	B1	B2	B3	B4	B5	B6	B7	B8
Type	F	F	F	F	F	F	F	F
Default	none	none	none	none	none	none	none	none
Remark	2							

Card 5 for Per Mole Calculation. Method (B) RUNIV is nonzero.

Card 5	1	2	3	4	5	6	7	8
Variable	C1	C2	C3	C4	C5	C6	C7	C8
Type	F	F	F	F	F	F	F	F
Default	none	none	none	none	none	none	none	none
Remark	2							

VARIABLE**DESCRIPTION**

MID	Material identification. A unique number or label not exceeding 8 characters must be specified.
IADIAB	This flag (default = 0) is used to turn ON/OFF adiabatic compression logics for an ideal gas (remark 5). EQ.0: OFF (default) EQ.1: ON
RUNIV	Universal gas constant in per-mole unit (8.31447 J/(mole*K)).
CVmass1 - CVmass8	If RUNIV is BLANK or zero (method A): Heat capacity at constant volume for up to eight different gases in per-mass unit.
CPmass1 - CPmass8	If RUNIV is BLANK or zero (method A): Heat capacity at constant pressure for up to eight different gases in per-mass unit.
MOLWT1 - MOLWT8	If RUNIV is nonzero (method B): Molecular weight of each ideal gas in the mixture (mass-unit/mole).
CPmole1 - CPmole8	If RUNIV is nonzero (method B): Heat capacity at constant pressure for up to eight different gases in per-mole unit. These are nominal heat capacity values typically at STP. These are denoted by the variable "A" in the equation in remark 2.
B1 - B8	If RUNIV is nonzero (method B): First order coefficient for a temperature dependent heat capacity at constant pressure for up to eight different gases. These are denoted by the variable "B" in the equation in remark 2.

VARIABLE	DESCRIPTION
----------	-------------

C1 - C8	If RUNIV is nonzero (method B): Second order coefficient for a temperature dependent heat capacity at constant pressure for up to eight different gases. These are denoted by the variable "C" in the equation in remark 2.
---------	---

Remarks:

1. There are 2 methods of defining the gas properties for the mixture. If RUNIV is BLANK or ZERO → Method (A) is used to define constant heat capacities where per-mass unit values of C_v and C_p are input. Only cards 2 and 3 are required for this method. Method (B) is used to define constant or temperature dependent heat capacities where per-mole unit values of C_p are input. Cards 2-5 are required for this method.
2. The per-mass-unit, temperature-dependent, constant-pressure heat capacity is

$$C_p(T) = \frac{(CPMOLE + B \times T + C \times T^2)}{MOLWT}$$

Typical metric units:

$C_p(T)$	CPMOLE	B	A
$\frac{J}{kg\ K}$	$\frac{J}{mole\ K}$	$\frac{J}{mole\ K^2}$	$\frac{J}{mole\ K^3}$

3. The initial temperature and the density of the gas species present in a mesh or part at time zero is specified by the keyword *INITIAL_GAS_MIXTURE.
4. The ideal gas mixture is assumed to be thermal equilibrium, that is, all species are at the same temperature (T). The gases in the mixture are also assumed to follow Dalton's Partial Pressure Law,

$$P = \sum_i^{ngas} P_i.$$

The partial pressure of each gas is then

$$P_i = \rho_i R_{gas_i} T$$

Where

$$R_{gas_i} = \frac{R_{univ}}{MOLWT}$$

The individual gas species temperature equals the mixture temperature. The temperature is computed from the internal energy where the *mixture internal energy per unit volume* is used,

$$T = T_i = \frac{e_V}{\sum_i^{\text{ngas}} \rho_i C_{V_i}}$$

whence

$$\begin{aligned} e_V &= \sum_i^{\text{ngas}} \rho_i C_{V_i} T_i \\ &= \sum_i^{\text{ngas}} \rho_i C_{V_i} T. \end{aligned}$$

In general, the advection step conserves momentum and internal energy, but not kinetic energy. This can result in energy lost in the system and lead to a pressure drop. In *MAT_GAS_MIXTURE the dissipated kinetic energy is automatically stored in the internal energy. Thus in effect the total energy is conserved instead of conserving just the internal energy. This numerical scheme has been shown to improve accuracy in some cases. However, the user should always be vigilant and check the physics of the problem closely.

- As an example consider an airbag surrounded by ambient air. As the inflator gas flows into the bag, the ALE elements cut by the airbag fabric shell elements will contain some inflator gas inside and some ambient air outside. The multi-material element treatment is not perfect. Consequently the temperature of the outside air may, occasionally, be made artificially high after the multi-material element treatment. To prevent the outside ambient air from getting artificially high T, set IDI-AB = 1 for the ambient air outside. Simple adiabatic compression equation is then assumed for the outside air. The use of this flag may be needed, but only when that outside air is modeled by the *MAT_GAS_MIXTURE card.

Example:

Consider a tank test model where the Lagrangian tank (Part S1) is surrounded by an ALE air mesh (Part H4 = AMMGID 1). There are 2 ALE parts which are defined but initially have no corresponding mesh: part 5 (H5 = AMMGID 2) is the resident gas inside the tank at $t = 0$, and part 6 (H6 = AMMGID 2) is the inflator gas(es) which is injected into the tank when $t > 0$. AMMGID stands for ALE Multi-Material Group ID. Please see figure and input below. The *MAT_GAS_MIXTURE (MGM) card defines the gas properties of ALE parts H5 & H6. The MGM card input for both method (A) and (B) are shown.

The *INITIAL_GAS_MIXTURE card is also shown. It basically specifies that "AMMGID 2 may be present in part or mesh H4 at $t = 0$, and the initial density of this gas is defined in

the rho1 position which corresponds to the 1st material in the mixture (or H5, the resident gas).”

Example configuration:

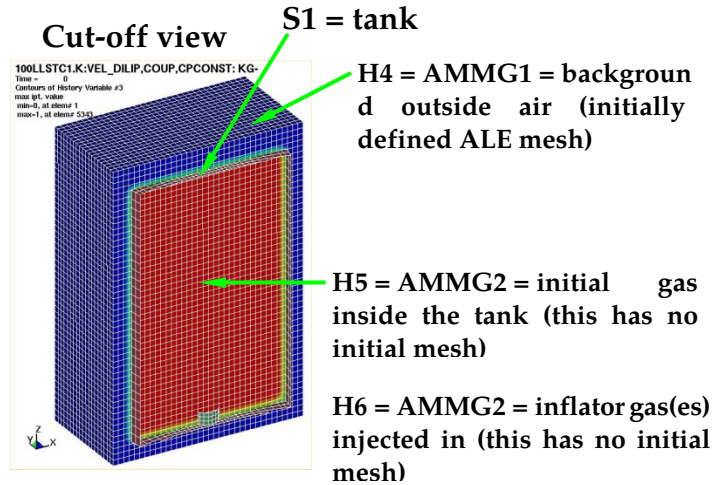

Sample input:

```

$-----
*PART
H5 = initial gas inside the tank
$      PID      SECID      MID      EOSID      HGID      GRAV      ADPOPT      TMID
$      5         5         5         0         5         0         0
*SECTION_SOLID
$      5         11         0
$-----
$ Example 1: Constant heat capacities using per-mass unit.
$*MAT_GAS_MIXTURE
$      MID      IADIAB      R_univ
$      5         0         0
$      Cv1_mas  Cv2_mas  Cv3_mas  Cv4_mas  Cv5_mas  Cv6_mas  Cv7_mas  Cv8_mas
$718.7828911237.56228
$      Cp1_mas  Cp2_mas  Cp3_mas  Cp4_mas  Cp5_mas  Cp6_mas  Cp7_mas  Cp8_mas
$1007.00058 1606.1117
$-----
$ Example 2: Variable heat capacities using per-mole unit.
$*MAT_GAS_MIXTURE
$      MID      IADIAB      R_univ
$      5         0      8.314470
$      MW1      MW2      MW3      MW4      MW5      MW6      MW7      MW8
$      0.0288479 0.02256
$      Cp1_mol  Cp2_mol  Cp3_mol  Cp4_mol  Cp5_mol  Cp6_mol  Cp7_mol  Cp8_mol
$      29.049852 36.23388
$      B1         B2         B3         B4         B5         B6         B7         B8
$      7.056E-3 0.132E-1
$      C1         C2         C3         C4         C5         C6         C7         C8
$      -1.225E-6 -0.190E-5
$-----
$ One card is defined for each AMMG that will occupy some elements of a mesh set
*INITIAL_GAS_MIXTURE
$      SID      STYPE      MMGID      T0
$      4         1         1      298.15

```

***MAT_ALE_GAS_MIXTURE**

***MAT_ALE_02**

```
$      RHO1      RHO2      RHO3      RHO4      RHO5      RHO6      RHO7      RHO8
1.17913E-9
*INITIAL_GAS_MIXTURE
$      SID      STYPE      MMGID      T0
      4      1      2      298.15
$      RHO1      RHO2      RHO3      RHO4      RHO5      RHO6      RHO7      RHO8
1.17913E-9
$-----
```

***MAT_ALE_VISCOUS**

This may also be referred to as MAT_ALE_03. This “fluid-like” material model is very similar to Material Type 9 (*MAT_NULL). It allows the modeling of non-viscous fluids with constant or variable viscosity. The variable viscosity is a function of an equivalent deviatoric strain rate. If inviscid material is modeled, the deviatoric or viscous stresses are zero, and the equation of state supplies the pressures (or diagonal components of the stress tensor). All *MAT_ALE_cards apply only to ALE element formulation.

Card 1	1	2	3	4	5	6	7	8
Variable	MID	RO	PC	MULO	MUHI	RK	Not used	RN
Type	I	F	F	F	F	F		F
Defaults	none	none	0.0	0.0	0.0	0.0		0.0

VARIABLE**DESCRIPTION**

MID	Material identification. A unique number has to be chosen.
RO	Mass density.
PC	Pressure cutoff (≤ 0.0), (See remark 4).
MULO	There are 4 possible cases (See remark 1): <ol style="list-style-type: none"> 1. If MULO = 0.0, then inviscid fluid is assumed. 2. If MULO > 0.0, and MUHI = 0.0 or is not defined, then this is the traditional constant dynamic viscosity coefficient μ. 3. If MULO > 0.0, and MUHI > 0.0, then MULO and MUHI are lower and upper viscosity limit values for a power-law-like variable viscosity model. 4. If MULO is negative (for example, MULO = -1), then a user-input data load curve (with LCID = 1) defining dynamic viscosity as a function of equivalent strain rate is used.
MUHI	Upper dynamic viscosity limit (default = 0.0). This is defined only if RK and RN are defined for the variable viscosity case.
RK	Variable dynamic viscosity multiplier (See remark 6).
RN	Variable dynamic viscosity exponent (See remark 6).

Remarks:

1. The null material must be used with an equation-of-state. Pressure cutoff is negative in tension. A (deviatoric) viscous stress of the form

$$\sigma'_{ij} = 2\mu\dot{\epsilon}'_{ij}$$

$$\left[\frac{N}{m^2}\right] \sim \left[\frac{N}{m^2}s\right] \left[\frac{1}{s}\right]$$

is computed for nonzero μ where $\dot{\epsilon}'_{ij}$ is the deviatoric strain rate. μ is the dynamic viscosity. For example, in SI unit system, μ has a unit of [Pa*s].

2. The null material has no shear stiffness and hourglass control must be used with care. In some applications, the default hourglass coefficient might lead to significant energy losses. In general for fluid(s), the hourglass coefficient QM should be small (in the range 1.0E-4 to 1.0E-6 for the standard default IHQ choice).
3. Null material has no yield strength and behaves in a fluid-like manner.
4. The pressure cut-off, PC, must be defined to allow for a material to “numerically” cavitate. In other words, when a material undergoes dilatation above certain magnitude, it should no longer be able to resist this dilatation. Since dilatation stress or pressure is negative, setting PC limit to a very small negative number would allow for the material to cavitate once the pressure in the material goes below this negative value.
5. If the viscosity exponent is less than 1.0, $RN < 1.0$, then $RN - 1.0 < 0.0$. In this case, at very low equivalent strain rate, the viscosity can be artificially very high. MULO is then used as the viscosity value.
6. The empirical variable dynamic viscosity is typically modeled as a function of equivalent shear rate based on experimental data.

$$\mu(\dot{\bar{\gamma}}') = RK \cdot \dot{\bar{\gamma}}'^{(RN-1)}$$

For an incompressible fluid, this may be written equivalently as

$$\mu(\dot{\bar{\epsilon}}') = RK \cdot \dot{\bar{\epsilon}}'^{(RN-1)}$$

The “overbar” denotes a scalar equivalence. The “dot” denotes a time derivative or rate effect. And the “prime” symbol denotes deviatoric or volume preserving components. The equivalent shear rate components may be related to the basic definition of (small-strain) strain rate components as follows:

$$\dot{\epsilon}_{ij} = \frac{1}{2} \left(\frac{\partial u_i}{\partial x_j} + \frac{\partial u_j}{\partial x_i} \right) \Rightarrow \dot{\epsilon}'_{ij} = \dot{\epsilon}_{ij} - \delta_{ij} \left(\frac{\dot{\epsilon}_{kk}}{3} \right)$$

$$\dot{\gamma}_{ij} = 2\dot{\epsilon}_{ij}$$

Typically, the 2nd invariant of the deviatoric strain rate tensor is defined as:

$$I_{2\dot{\epsilon}'} = \frac{1}{2} [\dot{\epsilon}'_{ij} \dot{\epsilon}'_{ij}]$$

The equivalent (small-strain) deviatoric strain rate is defined as:

$$\dot{\epsilon}' \equiv 2\sqrt{I_{2\dot{\epsilon}'}} = \sqrt{2[\dot{\epsilon}'_{ij} \dot{\epsilon}'_{ij}]} = \sqrt{4[\dot{\epsilon}'_{12}^2 + \dot{\epsilon}'_{23}^2 + \dot{\epsilon}'_{31}^2] + 2[\dot{\epsilon}'_{11}^2 + \dot{\epsilon}'_{22}^2 + \dot{\epsilon}'_{33}^2]}$$

In non-Newtonian literatures, the equivalent shear rate is sometimes defined as

$$\dot{\gamma} \equiv \sqrt{\frac{\hat{\gamma}_{ij} \hat{\gamma}_{ij}}{2}} = \sqrt{2\dot{\epsilon}_{ij} \dot{\epsilon}_{ij}} = \sqrt{4[\dot{\epsilon}_{12}^2 + \dot{\epsilon}_{23}^2 + \dot{\epsilon}_{31}^2] + 2[\dot{\epsilon}_{11}^2 + \dot{\epsilon}_{22}^2 + \dot{\epsilon}_{33}^2]}$$

It turns out that, (a) for incompressible materials ($\dot{\epsilon}_{kk} = 0$), and (b) the shear terms are equivalent when $i \neq j \rightarrow \dot{\epsilon}_{ij} = \dot{\epsilon}'_{ij}$, the equivalent shear rate is algebraically equivalent to the equivalent (small-strain) deviatoric strain rate.

$$\dot{\epsilon}' = \dot{\gamma}$$

***MAT_ALE_MIXING_LENGTH**

This may also be referred to as *MAT_ALE_04. This viscous “fluid-like” material model is an advanced form of *MAT_ALE_VISCOUS. It allows the modeling of fluid with constant or variable viscosity and a one-parameter mixing-length turbulence model. The variable viscosity is a function of an equivalent deviatoric strain rate. The equation of state supplies the pressures for the stress tensor. All *MAT_ALE_cards apply only to ALE element formulation.

Card Format

Card 1	1	2	3	4	5	6	7	8
Variable	MID	RO	PC	MULO	MUHI	RK	Not used	RN
Type	I	F	F	F	F	F		F
Defaults	none	0.0	0.0	0.0	0.0	0.0		0.0

Internal Flow Card.

Card 2	1	2	3	4	5	6	7	8
Variable	LC	C0	C1	C2	C3	C4	C5	C6
Type	F	F	F	F	F	F	F	F
Defaults	0.0	0.0	0.0	0.0	0.0	0.0	0.0	0.0

External Flow Card.

Card 3	1	2	3	4	5	6	7	8
Variable	LC	D0	D1	D2	E0	E1	E2	
Type	F	F	F	F	F	F	F	
Defaults	0.0	0.0	0.0	0.0	0.0	0.0	0.0	

VARIABLE	DESCRIPTION
MID	Material identification. A unique number has to be chosen.
RO	Mass density
PC	Pressure cutoff (≤ 0.0).
MULO	There are 3 possible cases: (1) If MULO > 0.0, and MUHI = 0.0 or is not defined, then this is the traditional constant dynamic viscosity coefficient μ . (2) If MULO > 0.0, and MUHI > 0.0, then MULO and MUHI are lower and upper viscosity limit values. (3) If MULO is negative (for example, MULO = -1), then a user-input data load curve (with LCID = 1) defining dynamic viscosity as a function of equivalent strain rate is used.
MUHI	Upper dynamic viscosity limit (default = 0.0). This is defined only if RK and RN are defined for the variable viscosity case.
RK	Variable dynamic viscosity multiplier. The viscosity is computed as $\mu(\bar{\dot{\epsilon}}') = rk \cdot \bar{\dot{\epsilon}}'^{(rn-1)}$ where the equivalent deviatoric strain rate is $\bar{\dot{\epsilon}}' = \sqrt{\frac{2}{3} [\dot{\epsilon}'_{11}^2 + \dot{\epsilon}'_{22}^2 + \dot{\epsilon}'_{33}^2 + 2(\dot{\epsilon}'_{12}^2 + \dot{\epsilon}'_{23}^2 + \dot{\epsilon}'_{31}^2)]}$
RN	Variable dynamic viscosity exponent (see below for details).
LCI	Characteristic length, l_{ci} , of the internal turbulent domain.
C0 - C6	Internal flow mixing length polynomial coefficients. The one-parameter turbulent mixing length is computed as $l_m = l_{ci} \left[C_0 + C_1 \left(1 - \frac{y}{l_{ci}} \right) + \dots + C_6 \left(1 - \frac{y}{l_{ci}} \right)^6 \right]$
LCX	Characteristic length, l_{cx} , of the external turbulent domain.
D0 - D2	External flow mixing length polynomial coefficients. If $y \leq l_{cx}$ then the mixing length is computed as $l_m = [D_0 + D_1 y + D_2 y^2]$
E0 - E2	External flow mixing length polynomial coefficients. If $y > l_{cx}$ then the mixing length is computed as $l_m = [E_0 + E_1 y + E_2 y^2]$

Remarks:

1. The null material must be used with an equation of-state. Pressure cutoff is negative in tension. A (deviatoric) viscous stress of the form

$$\sigma'_{ij} = \mu_{eff} \dot{\epsilon}'_{ij}$$

$$\left[\frac{N}{m^2} \right] \approx \left[\frac{N}{m^2} s \right] \left[\frac{1}{S} \right]$$

is computed for nonzero μ where ε'_{ij} is the deviatoric strain rate. μ is the dynamic viscosity with unit of [Pascal*second].

2. The null material has no shear stiffness and hourglass control must be used with care. In some applications, the default hourglass coefficient might lead to significant energy losses. In general for fluid(s), the hourglass coefficient QM should be small (in the range 1.0E-4 to 1.0E-6 for the standard default IHQ choice).
3. The Null material has no yield strength and behaves in a fluid-like manner.
4. The pressure cut-off, PC, must be defined to allow for a material to “numerically” cavitate. In other words, when a material undergoes dilatation above certain magnitude, it should no longer be able to resist this dilatation. Since dilatation stress or pressure is negative, setting PC limit to a very small negative number would allow for the material to cavitate once the pressure in the material goes below this negative value.
5. If the viscosity exponent is less than 1.0, μ , then μ . In this case, at very low equivalent strain rate, the viscosity can be artificially very high. MULO is then used as the viscosity value.
6. Turbulence is treated simply by considering its effects on viscosity. Total effective viscosity is the sum of the laminar and turbulent viscosities, μ where μ is the effective viscosity, and μ is the turbulent viscosity.
7. The turbulent viscosity is computed based on the Prandtl’s Mixing Length Model,

$$\mu_t = \rho l_m^2 |\nabla \mathbf{v}|$$

***MAT_ALE_05**

***MAT_ALE_INCOMPRESSIBLE**

***MAT_ALE_INCOMPRESSIBLE**

See *MAT_160.

*MAT_ALE_HERSCHEL

This may also be referred to as MAT_ALE_06. This is the Herschel-Buckley model. It is an enhancement to the power law viscosity model in *MAT_ALE_VISCOUS(*MAT_ALE_03). Two additional input parameters: the yield stress threshold and critical shear strain rate can be specified to model "rigid-like" material for low strain rates.

It allows the modeling of non-viscous fluids with constant or variable viscosity. The variable viscosity is a function of an equivalent deviatoric strain rate. All *MAT_ALE_cards apply only to ALE element formulation.

Card 1	1	2	3	4	5	6	7	8
Variable	MID	RO	PC	MULO	MUHI	RK	Not used	RN
Type	I	F	F	F	F	F		F
Defaults	none	none	0.0	0.0	0.0	0.0		0.0

Card 2	1	2	3	4	5	6	7	8
Variable	GDOTC	TA00						
Type	F	F						
Default	none	none						

VARIABLE	DESCRIPTION
MID	Material identification. A unique number has to be chosen.
RO	Mass density.
PC	Pressure cutoff (≤ 0.0), (See remark 4).

VARIABLE	DESCRIPTION
MULO	There are 4 possible cases (See remark 1): <ol style="list-style-type: none"> 1. If MULO = 0.0, then inviscid fluid is assumed. 2. If MULO > 0.0, and MUHI = 0.0 or is not defined, then this is the traditional constant dynamic viscosity coefficient μ. 3. If MULO > 0.0, and MUHI > 0.0, then MULO and MUHI are lower and upper viscosity limit values for a power-law-like variable viscosity model. 4. If MULO is negative (for example, MULO = -1), then a user-input data load curve (with LCID = 1) defining dynamic viscosity as a function of equivalent strain rate is used.
MUHI	Upper dynamic viscosity limit (default = 0.0). This is defined only if RK and RN are defined for the variable viscosity case.
RK	k ; consistency factor (See remark 6).
RN	n ; power law index (See remark 6).
GDOTC	$\dot{\gamma}_c$; critical shear strain rate (See remark 6).
TAO0	τ_0 ; yield stress (See remark 6).

Remarks:

1. The null material must be used with an equation-of-state. Pressure cutoff is negative in tension. A (deviatoric) viscous stress of the form

$$\sigma'_{ij} = 2\mu\dot{\epsilon}'_{ij}$$

$$\left[\frac{N}{m^2} \right] \sim \left[\frac{N}{m^2 s} \right] \left[\frac{1}{s} \right]$$

is computed for nonzero μ where $\dot{\epsilon}'_{ij}$ is the deviatoric strain rate. μ is the dynamic viscosity. For example, in SI unit system, μ has a unit of [Pa*s].

2. The null material has no shear stiffness and hourglass control must be used with care. In some applications, the default hourglass coefficient might lead to significant energy losses. In general for fluid(s), the hourglass coefficient QM should be small (in the range 1.0E-4 to 1.0E-6 for the standard default IHQ choice).
3. Null material has no yield strength and behaves in a fluid-like manner.
4. The pressure cut-off, PC, must be defined to allow for a material to “numerically” cavitate. In other words, when a material undergoes dilatation above certain mag-

nitude, it should no longer be able to resist this dilatation. Since dilatation stress or pressure is negative, setting PC limit to a very small negative number would allow for the material to cavitate once the pressure in the material goes below this negative value.

- 5. If the viscosity exponent is less than 1.0, $RN < 1.0$, then $RN - 1.0 < 0.0$. In this case, at very low equivalent strain rate, the viscosity can be artificially very high. MULO is then used as the viscosity value.
- 6. The Herschel-Buckley model employs a large viscosity to model the “rigid-like” behavior for low shear strain rates ($\dot{\gamma} < \dot{\gamma}_c$).

$$\mu = \mu_0$$

Power law is used once the yield stress is passed.

$$\mu(\dot{\gamma}) = \frac{\tau_0}{\dot{\gamma}} + k\left(\frac{\dot{\gamma}}{\dot{\gamma}_c}\right)^{n-1}$$

The shear strain rate is:

$$\dot{\gamma} \equiv \sqrt{\frac{\dot{\gamma}_{ij}\dot{\gamma}_{ij}}{2}} = \sqrt{2\dot{\epsilon}_{ij}\dot{\epsilon}_{ij}} = \sqrt{4[\dot{\epsilon}_{12}^2 + \dot{\epsilon}_{23}^2 + \dot{\epsilon}_{31}^2] + 2[\dot{\epsilon}_{11}^2 + \dot{\epsilon}_{22}^2 + \dot{\epsilon}_{33}^2]}$$

***MAT_SPRING_ELASTIC**

This is Material Type 1 for discrete springs and dampers. This provides a translational or rotational elastic spring located between two nodes. Only one degree of freedom is connected.

Card 1	1	2	3	4	5	6	7	8
Variable	MID	K						
Type	A8	F						

VARIABLE**DESCRIPTION**

MID	Material identification. A unique number or label not exceeding 8 characters must be specified.
K	Elastic stiffness (force/displacement) or (moment/rotation).

***MAT_DAMPER_VISCOUS**

This is Material Type 2 for discrete springs and dampers. This material provides a linear translational or rotational damper located between two nodes. Only one degree of freedom is then connected.

Card 1	1	2	3	4	5	6	7	8
Variable	MID	DC						
Type	A8	F						

<u>VARIABLE</u>	<u>DESCRIPTION</u>
MID	Material identification. A unique number or label not exceeding 8 characters must be specified.
DC	Damping constant (force/displacement rate) or (moment/rotation rate).

***MAT_SPRING_ELASTOPLASTIC**

This is Material Type 3 for discrete springs and dampers. This material provides an elasto-plastic translational or rotational spring with isotropic hardening located between two nodes. Only one degree of freedom is connected.

Card 1	1	2	3	4	5	6	7	8
Variable	MID	K	KT	FY				
Type	A8	F	F	F				

VARIABLE**DESCRIPTION**

MID	Material identification. A unique number or label not exceeding 8 characters must be specified.
K	Elastic stiffness (force/displacement) or (moment/rotation).
KT	Tangent stiffness (force/displacement) or (moment/rotation).
FY	Yield (force) or (moment).

*MAT_SPRING_NONLINEAR_ELASTIC

This is Material Type 4 for discrete springs and dampers. This material provides a nonlinear elastic translational and rotational spring with arbitrary force versus displacement and moment versus rotation, respectively. Optionally, strain rate effects can be considered through a velocity dependent scale factor. With the spring located between two nodes, only one degree of freedom is connected.

Card 1	1	2	3	4	5	6	7	8
Variable	MID	LCD	LCR					
Type	A8	I	I					

<u>VARIABLE</u>	<u>DESCRIPTION</u>
MID	Material identification. A unique number or label not exceeding 8 characters must be specified.
LCD	Load curve ID describing force versus displacement or moment versus rotation relationship. <u>The load curve must define the response in the negative and positive quadrants and pass through point (0,0).</u>
LCR	Optional load curve describing scale factor on force or moment as a function of relative velocity or. rotational velocity, respectively.

***MAT_DAMPER_NONLINEAR_VISCOUS**

This is Material Type 5 for discrete springs and dampers. This material provides a viscous translational damper with an arbitrary force versus velocity dependency, or a rotational damper with an arbitrary moment versus rotational velocity dependency. With the damper located between two nodes, only one degree of freedom is connected.

Card 1	1	2	3	4	5	6	7	8
Variable	MID	LCDR						
Type	A8	I						

VARIABLE**DESCRIPTION**

MID	Material identification. A unique number or label not exceeding 8 characters must be specified.
LCDR	Load curve identification describing force versus rate-of-displacement relationship or a moment versus rate-of-rotation relationship. <u>The load curve must define the response in the negative and positive quadrants and pass through point (0,0).</u>

***MAT_SPRING_GENERAL_NONLINEAR**

This is Material Type 6 for discrete springs and dampers. This material provides a general nonlinear translational or rotational spring with arbitrary loading and unloading definitions. Optionally, hardening or softening can be defined. With the spring located between two nodes, only one degree of freedom is connected.

Card 1	1	2	3	4	5	6	7	8
Variable	MID	LCDL	LCDU	BETA	TYI	CYI		
Type	A8	I	I	F	F	F		

VARIABLE**DESCRIPTION**

MID	Material identification. A unique number or label not exceeding 8 characters must be specified.
LCDL	Load curve identification describing force/torque versus displacement/rotation relationship for loading, see Figure 2-14 .
LCDU	Load curve identification describing force/torque versus displacement/rotation relationship for unloading, see Figure 2-60 .
BETA	Hardening parameter, β : EQ.0.0: tensile and compressive yield with strain softening (negative or zero slope allowed in the force versus displacement. load curves), NE.0.0: kinematic hardening without strain softening, EQ.1.0: isotropic hardening without strain softening.
TYI	Initial yield force in tension (> 0)
CYI	Initial yield force in compression (< 0)

Remarks:

Load curve points are in the format (displacement, force or rotation, moment). The points must be in order starting with the most negative (compressive) displacement or rotation and ending with the most positive (tensile) value. The curves need not be symmetrical.

The displacement origin of the “unloading” curve is arbitrary, since it will be shifted as necessary as the element extends and contracts. On reverse yielding the “loading” curve will also be shifted along the displacement re or. rotation axis. The initial tensile and compressive

Yield forces (TYI and CYI) define a range within which the element remains elastic (i.e. the “loading” curve is used for both loading and unloading). If at any time the force in the element exceeds this range, the element is deemed to have yielded, and at all subsequent times the “unloading” curve is used for unloading

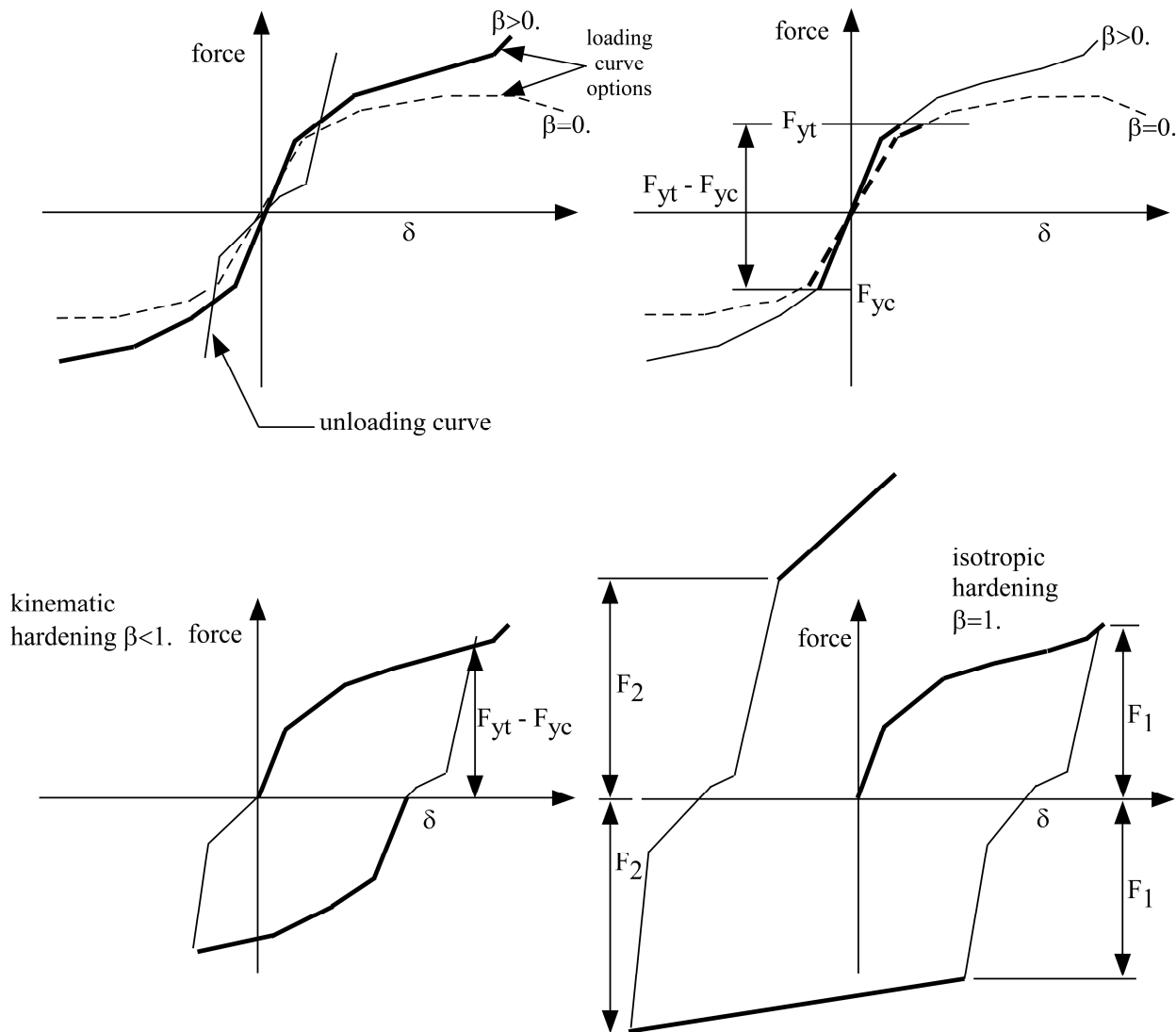

Figure 2-129. General Nonlinear material for discrete elements

*MAT_SPRING_MAXWELL

This is Material Type 7 for discrete springs and dampers. This material provides a three Parameter Maxwell Viscoelastic translational or rotational spring. Optionally, a cutoff time with a remaining constant force/moment can be defined.

Card 1	1	2	3	4	5	6	7	8
Variable	MID	K0	KI	BETA	TC	FC	COPT	
Type	A8	F	F	F	F	F	F	
Default					1020	0	0	

VARIABLE	DESCRIPTION
MID	Material identification. A unique number or label not exceeding 8 characters must be specified.
K0	K_0 , short time stiffness
KI	K_∞ , long time stiffness
BETA	Decay parameter.
TC	Cut off time. After this time a constant force/moment is transmitted.
FC	Force/moment after cutoff time
COPT	Time implementation option: EQ.0: incremental time change, NE.0: continuous time change.

Remarks:

The time varying stiffness $K(t)$ may be described in terms of the input parameters as

$$K(T) = K_\infty + (K_0 - K_\infty)\exp(-\beta t)$$

This equation was implemented by Schwer [1991] as either a continuous function of time or incrementally following the approach of Herrmann and Peterson [1968]. The continuous function of time implementation has the disadvantage of the energy absorber's resistance

decaying with increasing time even without deformation. The advantage of the incremental implementation is that an energy absorber must undergo some deformation before its resistance decays, i.e., there is no decay until impact, even in delayed impacts. The disadvantage of the incremental implementation is that very rapid decreases in resistance cannot be easily matched.

***MAT_SPRING_INELASTIC**

This is Material Type 8 for discrete springs and dampers. This material provides an inelastic tension or compression only, translational or rotational spring. Optionally, a user-specified unloading stiffness can be taken instead of the maximum loading stiffness.

Card 1	1	2	3	4	5	6	7	8
Variable	MID	LCFD	KU	CTF				
Type	A8	I	F	F				

VARIABLE**DESCRIPTION**

MID	Material identification. A unique number or label not exceeding 8 characters must be specified.
LCFD	Load curve identification describing arbitrary force/torque versus displacement/rotation relationship. This curve must be defined in the positive force-displacement quadrant regardless of whether the spring acts in tension or compression.
KU	Unloading stiffness (optional). The maximum of KU and the maximum loading stiffness in the force/displacement or the moment/rotation curve is used for unloading.
CTF	Flag for compression/tension: EQ.-1.0: tension only, EQ.0.0: default is set to 1.0, EQ.1.0: compression only.

***MAT_SPRING_TRILINEAR_DEGRADING**

This is Material Type 13 for discrete springs and dampers. This material allows concrete shearwalls to be modeled as discrete elements under applied seismic loading. It represents cracking of the concrete, yield of the reinforcement and overall failure. Under cyclic loading, the stiffness of the spring degrades but the strength does not.

Card 1	1	2	3	4	5	6	7	8
Variable	MID	DEFL1	F1	DEFL2	F2	DEFL3	F3	FFLAG
Type	A8	F	F	F	F	F	F	F

VARIABLE**DESCRIPTION**

MID	Material identification. A unique number or label not exceeding 8 characters must be specified.
DEFL1	Deflection at point where concrete cracking occurs.
F1	Force corresponding to DEFL1
DEFL2	Deflection at point where reinforcement yields
F2	Force corresponding to DEFL2
DEFL3	Deflection at complete failure
F3	Force corresponding to DEFL3
FFLAG	Failure flag.

*MAT_SPRING_SQUAT_SHEARWALL

This is Material Type 14 for discrete springs and dampers. This material allows squat shear walls to be modeled using discrete elements. The behavior model captures concrete cracking, reinforcement yield, ultimate strength followed by degradation of strength finally leading to collapse.

Card 1	1	2	3	4	5	6	7	8
Variable	MID	A14	B14	C14	D14	E14	LCID	FSD
Type	A8	F	F	F	F	F	I	F

VARIABLE	DESCRIPTION
MID	Material identification. A unique number or label not exceeding 8 characters must be specified.
A14	Material coefficient A
B14	Material coefficient B
C14	Material coefficient C
D14	Material coefficient D
E14	Material coefficient E
LCID	Load curve ID referencing the maximum strength envelope curve
FSD	Sustained strength reduction factor

Remarks:

Material coefficients A, B, C and D are empirically defined constants used to define the shape of the polynomial curves which govern the cyclic behavior of the discrete element. A different polynomial relationship is used to define the loading and unloading paths allowing energy absorption through hysteresis. Coefficient E is used in the definition of the path used to 'jump' from the loading path to the unloading path (or vice versa) where a full hysteresis loop is not completed. The load curve referenced is used to define the force displacement characteristics of the shear wall under monotonic loading. This curve is the basis to which the polynomials defining the cyclic behavior refer to. Finally, on the second and subsequent loading / unloading cycles, the shear wall will have reduced strength. The variable FSD is the sustained strength reduction factor.

***MAT_SPRING_MUSCLE**

This is Material Type 15 for discrete springs and dampers. This material is a Hill-type muscle model with activation. It is for use with discrete elements. The LS-DYNA implementation is due to Dr. J.A. Weiss.

Card 1	1	2	3	4	5	6	7	8
Variable	MID	L0	VMAX	SV	A	FMAX	TL	TV
Type	A8	F	F	F	F	F	F	F
Default		1.0		1.0			1.0	1.0

Card 2	1	2	3	4	5	6	7	8
Variable	FPE	LMAX	KSH					
Type	F	F	F					
Default	0.0							

VARIABLE**DESCRIPTION**

MID	Material identification. A unique number or label not exceeding 8 characters must be specified.
L0	Initial muscle length, L_0 .
VMAX	Maximum CE shortening velocity, V_{\max} .
SV	Scale factor, S_v , for V_{\max} vs. active state. LT.0: absolute value gives load curve ID GE.0: constant value of 1.0 is used
A	Activation level vs. time function. LT.0: absolute value gives load curve ID GE.0: constant value of A is used

VARIABLE	DESCRIPTION
FMAX	Peak isometric force, F_{\max} .
TL	Active tension vs. length function. LT.0: absolute value gives load curve ID GE.0: constant value of 1.0 is used
TV	Active tension vs. velocity function. LT.0: absolute value gives load curve ID GE.0: constant value of 1.0 is used
FPE	Force vs. length function, F_{pe} , for parallel elastic element. LT.0: absolute value gives load curve ID EQ.0: exponential function is used (see below) GT.0: constant value of 0.0 is used
LMAX	Relative length when F_{pe} reaches F_{\max} . Required if $F_{pe} = 0$ above.
KSH	Constant, K_{shr} , governing the exponential rise of F_{pe} . Required if $F_{pe} = 0$ above.

Remarks:

The material behavior of the muscle model is adapted from the original model proposed by Hill [1938]. Reviews of this model and extensions can be found in Winters [1990] and Zajac [1989]. The most basic Hill-type muscle model consists of a contractile element (CE) and a parallel elastic element (PE) ([Figure 2-130](#)). An additional series elastic element (SEE) can be added to represent tendon compliance. The main assumptions of the Hill model are that the contractile element is entirely stress free and freely distensible in the resting state, and is described exactly by Hill's equation (or some variation). When the muscle is activated, the series and parallel elements are elastic, and the whole muscle is a simple combination of identical sarcomeres in series and parallel. The main criticism of Hill's model is that the division of forces between the parallel elements and the division of extensions between the series elements is arbitrary, and cannot be made without introducing auxiliary hypotheses. However, these criticisms apply to *any* discrete element model. Despite these limitations, the Hill model has become extremely useful for modeling musculoskeletal dynamics, as illustrated by its widespread use today.

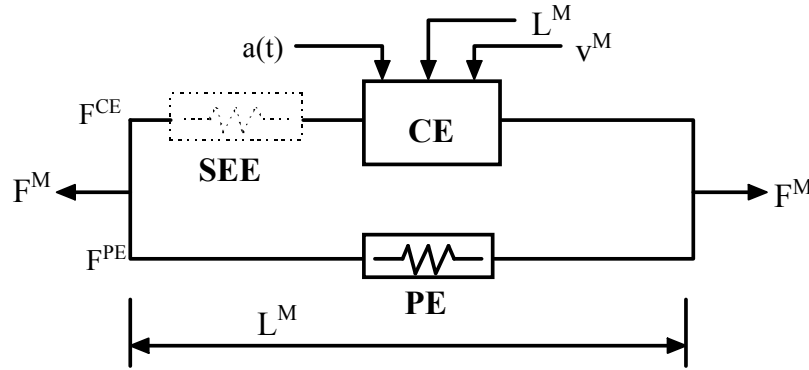

Figure 2-130. Discrete model for muscle contraction dynamics, based on a Hill-type representation. The total force is the sum of passive force F^{PE} and active force F^{CE} . The passive element (PE) represents energy storage from muscle elasticity, while the contractile element (CE) represents force generation by the muscle. The series elastic element (SEE), shown in dashed lines, is often neglected when a series tendon compliance is included. Here, $a(t)$ is the activation level, L^M is the length of the muscle, and v^M is the shortening velocity of the muscle.

When the contractile element (CE) of the Hill model is inactive, the entire resistance to elongation is provided by the PE element and the tendon load-elongation behavior. As activation is increased, force then passes through the CE side of the parallel Hill model, providing the contractile dynamics. The original Hill model accommodated only full activation - this limitation is circumvented in the present implementation by using the modification suggested by Winters (1990). The main features of his approach were to realize that the CE force-velocity input force equals the CE tension-length output force. This yields a three-dimensional curve to describe the force-velocity-length relationship of the CE. If the force-velocity y-intercept scales with activation, then given the activation, length and velocity, the CE force can be determined.

Without the SEE, the total force in the muscle F^M is the sum of the force in the CE and the PE because they are in parallel:

$$F^M = F^{PE} + F^{CE}$$

The relationships defining the force generated by the CE and PE as a function of L^M , v^M and $a(t)$ are often scaled by F_{max} , the peak isometric force (p. 80, Winters 1990), L_0 , the initial length of the muscle (p. 81, Winters 1990), and V_{max} , the maximum unloaded CE shortening velocity (p. 80, Winters 1990). From these, dimensionless length and velocity can be defined:

$$L = \frac{L^M}{L_0},$$

$$V = \frac{v^M}{V_{max} \times S_V[a(t)]}$$

Here, S_V scales the maximum CE shortening velocity V_{\max} and changes with activation level $a(t)$. This has been suggested by several researchers, i.e. Winters and Stark [1985]. The activation level specifies the level of muscle stimulation as a function of time. Both have values between 0 and 1. The functions $S_V(a(t))$ and $a(t)$ are specified via load curves in LS-DYNA, or default values of $S_V = 1$ and $a(t)=0$ are used. Note that L is always positive and that V is positive for lengthening and negative for shortening.

The relationship between F^{CE} , V and L was proposed by Bahler et al. [1967]. A three-dimensional relationship between these quantities is now considered standard for computer implementations of Hill-type muscle models [Winters 1990]. It can be written in dimensionless form as:

$$F^{\text{CE}} = a(t) \times F_{\max} \times f_{\text{TL}}(L) \times f_{\text{TV}}(V)$$

Here, f_{TL} and f_{TV} are the tension-length and tension-velocity functions for active skeletal muscle. Thus, if current values of L^{M} , V^{M} , and $a(t)$ are known, then F^{CE} can be determined.

The force in the parallel elastic element F^{PE} is determined directly from the current length of the muscle using an exponential relationship [Winters 1990]:

$$f_{\text{PE}} = \frac{F^{\text{PE}}}{F_{\text{MAX}}} = 0, L \leq 1$$

$$f_{\text{PE}} = \frac{F^{\text{PE}}}{F_{\text{MAX}}} = \frac{1}{\exp(K_{\text{sh}}) - 1} \left\{ \exp \left[\frac{K_{\text{sh}}}{L_{\max}} (L - 1) \right] - 1 \right\}, \quad L > 1$$

Here, L_{\max} is the relative length at which the force F_{\max} occurs, and K_{sh} is a dimensionless shape parameter controlling the rate of rise of the exponential. Alternatively, the user can define a custom f_{PE} curve giving tabular values of normalized force versus dimensionless length as a load curve.

For computation of the total force developed in the muscle F^{M} , the functions for the tension-length f_{TL} and force-velocity f_{TV} relationships used in the Hill element must be defined. These relationships have been available for over 50 years, but have been refined to allow for behavior such as active lengthening. The active tension-length curve f_{TL} describes the fact that isometric muscle force development is a function of length, with the maximum force occurring at an optimal length. According to Winters, this optimal length is typically around $L = 1.05$, and the force drops off for shorter or longer lengths, approaching zero force for $L = 0.4$ and $L = 1.5$. Thus the curve has a bell-shape. Because of the variability in this curve between muscles, the user must specify the function f_{TL} via a load curve, specifying pairs of points representing the normalized force (with values between 0 and 1) and normalized length L ([Figure 2-131](#)).

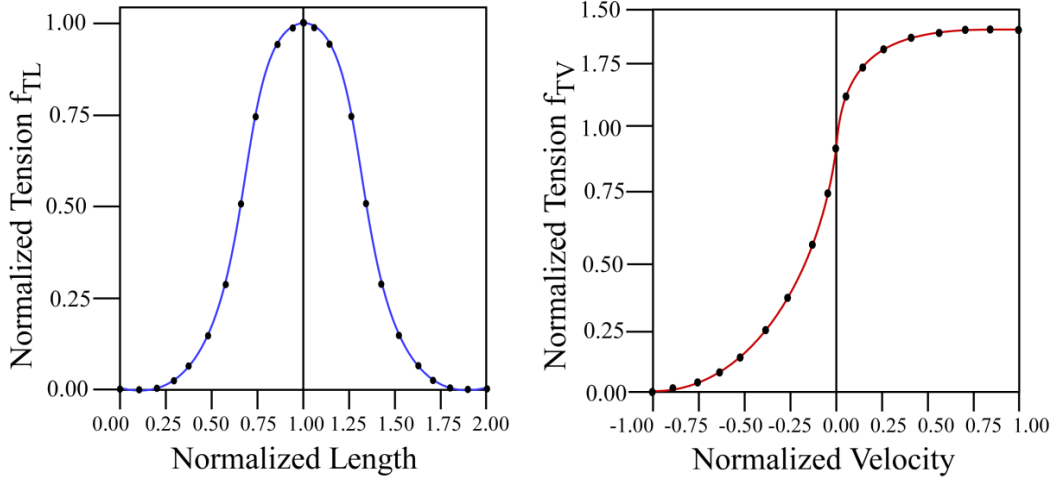

Figure 2-131. Typical normalized tension-length (TL) and tension-velocity (TV) curves for skeletal muscle. The active tension-velocity relationship f_{TV} used in the muscle model is mainly due to the original work of Hill. Note that the dimensionless velocity V is used. When $V = 0$, the normalized tension is typically chosen to have a value of 1.0. When V is greater than or equal to 0, muscle lengthening occurs. As V increases, the function is typically designed so that the force increases from a value of 1.0 and asymptotes towards a value near 1.4. When V is less than zero, muscle shortening occurs and the classic Hill equation hyperbola is used to drop the normalized tension to 0. The user must specify the function f_{TV} via a load curve, specifying pairs of points representing the normalized tension (with values between 0 and 1) and normalized velocity V .

***MAT_SEATBELT**

Purpose: Define a seat belt material. See notes below.

Card 1	1	2	3	4	5	6	7	8
Variable	MID	MPUL	LLCID	ULCID	LMIN	CSE	DAMP	
Type	A8	F	I	I	F	F	F	
Default	0	0.	0	0	0.0	0.0	0.0	

VARIABLE**DESCRIPTION**

MID	Belt material number. A unique number or label not exceeding 8 characters must be specified.
MPUL	Mass per unit length
LLCID	Load curve identification for loading (force vs. engineering strain).
ULCID	Load curve identification for unloading (force vs. engineering strain).
LMIN	Minimum length (for elements connected to slip rings and retractors), see notes below.
CSE	Optional compressive stress elimination option which applies to shell elements only (default 0.0): EQ.0.0: eliminate compressive stresses in shell fabric EQ.1.0: don't eliminate compressive stresses. This option should not be used if retractors and slings are present in the model. EQ.2.0: whether or not compressive stress is eliminated is decided by ls-dyna automatically, recommended for shell belt.
DAMP	Optional Rayleigh damping coefficient, which applies to shell elements only. A coefficient value of 0.10 is the default corresponding to 10% of critical damping. Sometimes smaller or larger values work better.

Remarks:

Each belt material defines stretch characteristics and mass properties for a set of belt elements. The user enters a load curve for loading, the points of which are (Strain, Force). Strain is defined as engineering strain, i.e.

$$\text{Strain} = \frac{\text{current length}}{\text{initial length}} - 1.0$$

Another similar curve is entered to describe the unloading behavior. Both load curves should start at the origin (0,0) and contain positive force and strain values only. The belt material is tension only with zero forces being generated whenever the strain becomes negative. The first non-zero point on the loading curve defines the initial yield point of the material. On unloading, the unloading curve is shifted along the strain axis until it crosses the loading curve at the 'yield' point from which unloading commences. If the initial yield has not yet been exceeded or if the origin of the (shifted) unloading curve is at negative strain, the original loading curves will be used for both loading and unloading. If the strain is less than the strain at the origin of the unloading curve, the belt is slack and no force is generated. Otherwise, forces will then be determined by the unloading curve for unloading and reloading until the strain again exceeds yield after which the loading curves will again be used.

A small amount of damping is automatically included. This reduces high frequency oscillation, but, with realistic force-strain input characteristics and loading rates, does not significantly alter the overall forces-strain performance. The damping force opposes the relative motion of the nodes and is limited by stability:

$$D = \frac{0.1 \times \text{mass} \times \text{relative velocity}}{\text{time step size}}$$

In addition, the magnitude of the damping force is limited to one-tenth of the force calculated from the force-strain relationship and is zero when the belt is slack. Damping forces are not applied to elements attached to slings and retractors.

The user inputs a mass per unit length that is used to calculate nodal masses on initialization.

A 'minimum length' is also input. This controls the shortest length allowed in any element and determines when an element passes through slings or are absorbed into the retractors. One tenth of a typical initial element length is usually a good choice.

***MAT_THERMAL_{OPTION}**

Available options include:

ISOTROPIC
ORTHOTROPIC
ISOTROPIC_TD
ORTHOTROPIC_TD
DISCRETE_BEAM
CWM
ORTHOTROPIC_TD_LC
ISOTROPIC_PHASE_CHANGE
ISOTROPIC_TD_LC
USER_DEFINED

The *MAT_THERMAL_cards allow thermal properties to be defined in coupled structural/thermal and thermal only analyses, see *CONTROL_SOLUTION. Thermal properties must be defined for all solid and shell elements in such analyses. Thermal properties need not be defined for beam or discrete elements as these elements are not accounted for in the thermal phase of the calculation. However dummy thermal properties will be echoed for these elements in the D3HSP file.

Thermal material properties are specified by a thermal material ID number (TMID), this number is independent of the material ID number (MID) defined on all other *MAT_... property cards. In the same analysis identical TMID and MID numbers may exist. The TMID and MID numbers are related through the *PART card.

***MAT_THERMAL_ISOTROPIC**

This is thermal material type 1. It allows isotropic thermal properties to be defined.

Card 1	1	2	3	4	5	6	7	8
Variable	TMID	TRO	TGRLC	TGMULT	TLAT	HLAT		
Type	A8	F	F	F	F	F		

Card 2	1	2	3	4	5	6	7	8
Variable	HC	TC						
Type	F	F						

VARIABLE**DESCRIPTION**

TMID	Thermal material identification. A unique number or label not exceeding 8 characters must be specified.
TRO	Thermal density: EQ.0.0: default to structural density.
TGRLC	Thermal generation rate curve number, see *DEFINE_CURVE: GT.0: function versus time, EQ.0: use constant multiplier value, TGMULT, LT.0: function versus temperature.
TGMULT	Thermal generation rate multiplier: EQ.0.0: no heat generation.
TLAT	Phase change temperature
HLAT	Latent heat
HC	Specific heat
TC	Thermal conductivity

*MAT_THERMAL_ORTHOTROPIC

This is thermal material type 2. It allows orthotropic thermal properties to be defined.

Card 1	1	2	3	4	5	6	7	8
Variable	TMID	TRO	TGRLC	TGMULT	AOPT	TLAT	HLAT	
Type	A8	F	F	F	F	F	F	

Card 2	1	2	3	4	5	6	7	8
Variable	HC	K1	K2	K3				
Type	F	F	F	F				

Card 3	1	2	3	4	5	6	7	8
Variable	XP	YP	ZP	A1	A2	A3		
Type	F	F	F	F	F	F		

Card 4	1	2	3	4	5	6	7	8
Variable	D1	D2	D3					
Type	F	F	F					

VARIABLE

DESCRIPTION

TMID

Thermal material identification. A unique number or label not exceeding 8 characters must be specified.

TRO

Thermal density:

EQ.0.0: default to structural density.

VARIABLE	DESCRIPTION
TGRLC	Thermal generation rate curve number, see *DEFINE_CURVE: GT.0: function versus time, EQ.0: use constant multiplier value, TGMULT, LT.0: function versus temperature.
TGMULT	Thermal generation rate multiplier: EQ.0.0: no heat generation.
AOPT	Material axes definition: EQ.0.0: locally orthotropic with material axes by element nodes N1, N2 and N4, EQ.1.0: locally orthotropic with material axes determined by a point in space and global location of element center, EQ.2.0: globally orthotropic with material axes determined by vectors.
TLAT	Phase change temperature
HLAT	Latent heat
HC	Specific heat
K1	Thermal conductivity K1 in local x-direction
K2	Thermal conductivity K2 in local y-direction
K3	Thermal conductivity K3 in local z-direction
XP, YP, ZP	Define coordinate of point p for AOPT = 1
A1, A2, A3	Define components of vector a for AOPT = 2
D1, D2, D3	Define components of vector v for AOPT = 2

***MAT_THERMAL_ISOTROPIC_TD**

This is thermal material type 3. It allows temperature dependent isotropic properties to be defined. The temperature dependency is defined by specifying a minimum of two and a maximum of eight data points. The properties must be defined for the temperature range that the material will see in the analysis.

Card 1	1	2	3	4	5	6	7	8
Variable	TMID	TRO	TGRLC	TGMULT	TLAT	HLAT		
Type	A8	F	F	F	F	F		

Card 2	1	2	3	4	5	6	7	8
Variable	T1	T2	T3	T4	T5	T6	T7	T8
Type	F	F	F	F	F	F	F	F

Card 3	1	2	3	4	5	6	7	8
Variable	C1	C2	C3	C4	C5	C6	C7	C8
Type	F	F	F	F	F	F	F	F

Card 4	1	2	3	4	5	6	7	8
Variable	K1	K2	K3	K4	K5	K6	K7	K8
Type	F	F	F	F	F	F	F	F

VARIABLE**DESCRIPTION**

TMID

Thermal material identification. A unique number or label not exceeding 8 characters must be specified.

VARIABLE	DESCRIPTION
TRO	Thermal density: EQ.0.0 default to structural density.
TGRLC	Thermal generation rate curve number, see *DEFINE_CURVE: GT.0: function versus time, EQ.0: use constant multiplier value, TGMULT, LT.0: function versus temperature.
TGMULT	Thermal generation rate multiplier: EQ.0.0: no heat generation.
TLAT	Phase change temperature
HLAT	Latent heat
T1, ..., T8	Temperatures: T1, ..., T8
C1, ..., C8	Specific heat at: T1, ..., T8
K1, ..., K8	Thermal conductivity at: T1, ..., T8

***MAT_THERMAL_ORTHOTROPIC_TD**

This is thermal material type 4. It allows temperature dependent orthotropic properties to be defined. The temperature dependency is defined by specifying a minimum of two and a maximum of eight data points. The properties must be defined for the temperature range that the material will see in the analysis.

Card 1	1	2	3	4	5	6	7	8
Variable	TMID	TRO	TGRLC	TGMULT	AOPT	TLAT	HLAT	
Type	A8	F	F	F	F	F	F	

Card 2	1	2	3	4	5	6	7	8
Variable	T1	T2	T3	T4	T5	T6	T7	T8
Type	F	F	F	F	F	F	F	F

Card 3	1	2	3	4	5	6	7	8
Variable	C1	C2	C3	C4	C5	C6	C7	C8
Type	F	F	F	F	F	F	F	F

Card 4	1	2	3	4	5	6	7	8
Variable	(K1)1	(K1)2	(K1)3	(K1)4	(K1)5	(K1)6	(K1)7	(K1)8
Type	F	F	F	F	F	F	F	F

Card 5	1	2	3	4	5	6	7	8
Variable	(K2)1	(K2)2	(K2)3	(K2)4	(K2)5	(K2)6	(K2)7	(K2)8
Type	F	F	F	F	F	F	F	F

Card 6	1	2	3	4	5	6	7	8
Variable	(K3)1	(K3)2	(K3)3	(K3)4	(K3)5	(K3)6	(K3)7	(K3)8
Type	F	F	F	F	F	F	F	F

Card 7	1	2	3	4	5	6	7	8
Variable	XP	YP	ZP	A1	A2	A3		
Type	F	F	F	F	F	F		

Card 8	1	2	3	4	5	6	7	8
Variable	D1	D2	D3					
Type	F	F	F					

VARIABLE**DESCRIPTION**

TMID	Thermal material identification. A unique number or label not exceeding 8 characters must be specified.
TRO	Thermal density: EQ.0.0: default to structural density.
TGRLC	Thermal generation rate curve number, see *DEFINE_CURVE: GT.0: function versus time, EQ.0: use constant multiplier value, TGMULT, LT.0: function versus temperature.
TGMULT	Thermal generation rate multiplier: EQ.0.0: no heat generation.

VARIABLE	DESCRIPTION
AOPT	Material axes definition: (see Mat_ORTHOTROPIC_ELASTIC for a more complete description): EQ.0.0: locally orthotropic with material axes by element nodes N1, N2 and N4, EQ.1.0: locally orthotropic with material axes determined by a point in space and global location of element center, EQ.2.0: globally orthotropic with material axes determined by vectors.
TLAT	Phase change temperature
HLAT	Latent heat
T1 ... T8	Temperatures: T1 ... T8
C1 ... C8	Specific heat at T1 ... T8
(K1)1 ... (K1)8	Thermal conductivity K_1 in local x-direction at T1 ... T8
(K2)1 ... (K2)8	Thermal conductivity K_2 in local y-direction at T1 ... T8
(K3)1 ... (K3)8	Thermal conductivity K_3 in local z-direction at T1 ... T8
XP, YP, ZP	Define coordinate of point \mathbf{p} for AOPT = 1
A1, A2, A3	Define components of vector \mathbf{a} for AOPT = 2
D1, D2, D3	Define components of vector \mathbf{d} for AOPT = 2

***MAT_THERMAL_DISCRETE_BEAM**

This is thermal material type 5. It defines properties for discrete beams. It is only applicable when used with *SECTION_BEAM elform = 6.

Card 1	1	2	3	4	5	6	7	8
Variable	TMID	TRO						
Type	A8	F						

Card 2	1	2	3	4	5	6	7	8
Variable	HC	TC						
Type	F	F						

VARIABLE**DESCRIPTION**

TMID	Thermal material identification. A unique number or label not exceeding 8 characters must be specified.
TRO	Thermal density: EQ.0.0: default to structural density.
HC	Specific heat
HC	Thermal conductance (SI units are W/K) $HC = (\text{heat transfer coefficient}) \times (\text{beam cross section area})$ $[W/K] = [W / m^2 K] * [m^2]$

Note:

A beam cross section area is not defined on the SECTION_BEAM keyword for an elform = 6 discrete beam. A beam cross section area is needed for heat transfer calculations. Therefore, the cross section area is lumped into the value entered for HC.

*MAT_THERMAL_CWM

This is thermal material type 7. It is a thermal material with temperature dependent properties that allows for material creation triggered by temperature. The acronym CWM stands for Computational Welding Mechanics and the model is intended to be used for simulating multistage weld processes in combination with the mechanical counterpart, *MAT_CWM.

Card 1	1	2	3	4	5	6	7	8
Variable	TMID	TRO	TGRLC	TGMULT				
Type	A8	F	F	F				

Card 2	1	2	3	4	5	6	7	8
Variable	LCHC	LCTC	TLSTART	TLEND	TISTART	TIEND	HGHOST	TGHOST
Type	F	F	F	F	F	F	F	F

VARIABLE	DESCRIPTION
TMID	Thermal material identification. A unique number or label not exceeding 8 characters must be specified.
TRO	Thermal density: EQ.0.0 default to structural density.
TGRLC	Thermal generation rate curve number, see *DEFINE_CURVE: GT.0: function versus time, EQ.0: use constant multiplier value, TGMULT, LT.0: function versus temperature.
TGMULT	Thermal generation rate multiplier: EQ.0.0: no heat generation.
LCHC	Load curve for specific heat as function of temperature
LCTC	Load curve for thermal conductivity as function of temperature

VARIABLE	DESCRIPTION
TLSTART	Birth temperature of material start
TLEND	Birth temperature of material end
TISTART	Birth time start
TIEND	Birth time end
HGHOST	Specific heat for ghost (quiet) material
TGHOST	Thermal conductivity for ghost (quiet) material

Remarks:

This material is initially in a quiet state, sometimes referred to as a ghost material. In this state the material has the thermal properties defined by the quiet specific heat and quiet thermal conductivity. These should represent void, e.g., by picking a relatively small thermal conductivity. The specific heat must be chosen with care though, since the temperature must be allowed to increase at a reasonable rate due to the heat from the weld source. When the temperature reaches the birth temperature, a history variable representing the indicator of the welding material is incremented. This variable follows

$$\gamma(t) = \min \left[1, \left(\max_{s \leq t} \gamma(s), \frac{T - T_l^{\text{start}}}{T_l^{\text{end}} - T_l^{\text{start}}} \right) \right]$$

The effective thermal material properties are interpolated as

$$\begin{aligned} \tilde{c}_p &= c_p(T)\gamma + c_p^{\text{quiet}}(1 - \gamma) \\ \tilde{\mu} &= \mu(T)\gamma + \mu^{\text{quiet}}(1 - \gamma) \end{aligned}$$

where c_p and μ are the specific heat and thermal conductivity, respectively. The time parameters for creating the material provides additional formulae for the final values of the thermal properties, resulting in

$$c_p = \begin{cases} 10^{10} c_p(T) & t \leq t_i^{\text{start}} \\ \tilde{c}_p \frac{t - t_i^{\text{start}}}{t_i^{\text{end}} - t_i^{\text{start}}} + 10^{10} c_p(T) \frac{t - t_i^{\text{end}}}{t_i^{\text{start}} - t_i^{\text{end}}} & t_i^{\text{start}} < t \leq t_i^{\text{end}} \\ \tilde{c}_p & t_i^{\text{end}} < t \end{cases}$$

$$\mu = \begin{cases} 0 & t \leq t_i^{\text{start}} \\ \tilde{\mu} \frac{t - t_i^{\text{start}}}{t_i^{\text{end}} - t_i^{\text{start}}} & t_i^{\text{start}} < t \leq t_i^{\text{end}} \\ \tilde{\mu} & t_i^{\text{end}} < t \end{cases}$$

The reason for introducing these time parameters is to keep a welding layer inactive during a specific stage in the simulation, allowing for seamless multistage welding. Prior to the birth time, the temperature is kept more or less constant due to the large specific heat and thus the material is prevented from being created.

***MAT_THERMAL_ORTHOTROPIC_TD_LC**

This is thermal material type 8. It allows temperature dependent orthotropic properties to be defined by load curves. The temperature dependency is defined by specifying a minimum of two data points. The properties must be defined for the temperature range that the material will see in the analysis.

Card 1	1	2	3	4	5	6	7	8
Variable	TMID	TRO	TGRLC	TGMULT	AOPT	TLAT	HLAT	
Type	A8	F	F	F	F	F	F	

Card 2	1	2	3	4	5	6	7	8
Variable	LCC	LCK1	LCK2	LCK3				
Type	I	I	I	I				

Card 3	1	2	3	4	5	6	7	8
Variable	XP	YP	ZP	A1	A2	A3		
Type	F	F	F	F	F	F		

Card 4	1	2	3	4	5	6	7	8
Variable	D1	D2	D3					
Type	F	F	F					

VARIABLE**DESCRIPTION**

TMID

Thermal material identification. A unique number or label not exceeding 8 characters must be specified.

VARIABLE	DESCRIPTION
TRO	Thermal density: EQ.0.0: default to structural density.
TGRLC	Thermal generation rate curve number, see *DEFINE_CURVE: GT.0: function versus time, EQ.0: use constant multiplier value, TGMULT, LT.0: function versus temperature.
TGMULT	Thermal generation rate multiplier: EQ.0.0: no heat generation.
AOPT	Material axes definition: (see Mat_OPTION TROPIC_ELASTIC for a more complete description): EQ.0.0: locally orthotropic with material axes by element nodes N1, N2 and N4, EQ.1.0: locally orthotropic with material axes determined by a point in space and global location of element center, EQ.2.0: globally orthotropic with material axes determined by vectors.
TLAT	Phase change temperature
HLAT	Latent heat
LCC	Load Curve Specific Heat
LCK1	Load Curve Thermal Conductivity K ₁ in local x-direction
LCK2	Load Curve Thermal Conductivity K ₂ in local y-direction
LCK3	Load Curve Thermal Conductivity K ₃ in local z-direction
XP, YP, ZP	Define coordinate of point p for AOPT = 1
A1, A2, A3	Define components of vector a for AOPT = 2
D1, D2, D3	Define components of vector d for AOPT = 2

Remarks:

See *MAT_THERMAL_ORTHOTROPIC keyword for a description of the orthotropic axis options, AOPT.

***MAT_THERMAL_ISOTROPIC_PHASE_CHANGE**

This is thermal material type 9. It allows temperature dependent isotropic properties with phase change to be defined. The latent heat of the material is defined together with the solid and liquid temperatures. The temperature dependency is defined by specifying a minimum of two and a maximum of eight data points. The properties must be defined for the temperature range that the material will see in the analysis.

Card 1	1	2	3	4	5	6	7	8
Variable	TMID	TR0	TGRLC	TGMULT				
Type	A8	F	F	F				

Card 2	1	2	3	4	5	6	7	8
Variable	T1	T2	T3	T4	T5	T6	T7	T8
Type	F	F	F	F	F	F	F	F

Card 3	1	2	3	4	5	6	7	8
Variable	C1	C2	C3	C4	C5	C6	C7	C8
Type	F	F	F	F	F	F	F	F

Card 4	1	2	3	4	5	6	7	8
Variable	K1	K2	K3	K4	K5	K6	K7	K8
Type	F	F	F	F	F	F	F	F

Card 5	1	2	3	4	5	6	7	8
Variable	SOLT	LIQT	LH					
Type	F	F	F					

VARIABLE**DESCRIPTION**

TMID	Thermal material identification. A unique number or label not exceeding 8 characters must be specified.
TRO	Thermal density: EQ.0.0: default to structural density.
TGRLC	Thermal generation rate curve number, see *DEFINE_CURVE: GT.0: function versus time, EQ.0: use constant multiplier value, TGMULT, LT.0: function versus temperature.
TGMULT	Thermal generation rate multiplier: EQ.0.0: no heat generation.
T1, ..., T8	Temperatures (T1, ..., T8)
C1, ..., C8	Specific heat at T1, ..., T8
K1, ..., K8	Thermal conductivity at T1, ..., T8
SOLT	Solid temperature, T_S (must be $< T_L$)
LIQT	Liquid temperature, T_L (must be $> T_S$)
LH	Latent heat

Remarks:

During phase change, that is between the solid and liquid temperatures, the specific heat of the material will be enhanced to account for the latent heat as follows:

$$c(t) = m \left[1 - \cos 2\pi \left(\frac{T - T_S}{T_L - T_S} \right) \right], \quad T_S < T < T_L$$

where

T_L = liquid temperature

T_S = solid temperature

T = temperature

m = multiplier such that $\lambda = \int_{T_S}^{T_L} C(T)dT$

λ = latent heat

c = specific heat

***MAT_THERMAL_ISOTROPIC_TD_LC**

This is thermal material type 10. It allows isotropic thermal properties that are temperature dependent specified by load curves to be defined. The properties must be defined for the temperature range that the material will see in the analysis.

Card 1	1	2	3	4	5	6	7	8
Variable	TMID	TRO	TGRLC	TGMULT				
Type	A8	F	F	F				

Card 2	1	2	3	4	5	6	7	8
Variable	HCLC	TCLC						
Type	F	F						

VARIABLE**DESCRIPTION**

TMID	Thermal material identification. A unique number or label not exceeding 8 characters must be specified.
TRO	Thermal density: EQ.0.0: default to structural density.
TGRLC	Thermal generation rate curve number, see *DEFINE_CURVE: GT.0: function versus time, EQ.0: use constant multiplier value, TGMULT, LT.0: function versus temperature.
TGMULT	Thermal generation rate multiplier: EQ.0.0: no heat generation.
HCLC	Load curve ID specifying specific heat vs. temperature.
TCLC	Load curve ID specifying thermal conductivity vs. temperature.

*MAT_THERMAL_USER_DEFINED

These are Thermal Material Types 11 - 15. The user can supply his own subroutines. Please consult Appendix H for more information.

Card 1	1	2	3	4	5	6	7	8
Variable	MID	RO	MT	LMC	NVH	AOPT	IORTHO	IHVE
Type	A8	F	F	F	F	F	F	F

Orthotropic Card 1. Additional card read in when IORTHO = 1.

Card 2	1	2	3	4	5	6	7	8
Variable	XP	YP	ZP	A1	A2	A3		
Type	F	F	F	F	F	F		

Orthotropic Card 2. Additional card read in when IORTHO = 1.

Card 3	1	2	3	4	5	6	7	8
Variable	D1	D2	D3					
Type	F	F	F					

Material Parameter Cards. Set up to 8 parameters per card. Include up to 4 cards. This input ends at the next keyword ("*") card.

Card 4	1	2	3	4	5	6	7	8
Variable	P1	P2	P3	P4	P5	P6	P7	P8
Type	F	F	F	F	F	F	F	F

VARIABLE

DESCRIPTION

MID

Material identification. A unique number or label not exceeding 8 characters must be specified.

VARIABLE	DESCRIPTION
RO	Thermal mass density.
MT	User material type (11-15 inclusive).
LMC	Length of material constants array. LMC must not be greater than 32.
NVH	Number of history variables.
AOPT	Material axes option of orthotropic materials. Use if IORTHO = 1.0. EQ.0.0: locally orthotropic with material axes by element nodes N1, N2 and N4, EQ.1.0: locally orthotropic with material axes determined by a point in space and global location of element center, EQ.2.0: globally orthotropic with material axes determined by vectors. LT.0.0: the absolute value of AOPT is a coordinate system ID number (CID on *DEFINE_COORDINATE_NODES, *DEFINE_COORDINATE_SYSTEM or *DEFINE_COORDINATE_VECTOR). Available in R3 version of 971 and later.
IORTHO	Set to 1.0 if the material is orthotropic.
IHVE	Set to 1.0 to activate exchange of history variables between mechanical and thermal user material models.
XP - D3	Material axes orientation of orthotropic materials. Use if IORTHO = 1.0
P1	First material parameter.
⋮	⋮
PLMC	LMCth material parameter.

Remarks:

1. The IHVE = 1 option makes it possible for a thermal user material subroutine to read the history variables of a mechanical user material subroutine defined for the same part and vice versa. If the integration points for the thermal and mechanical

elements are not coincident then extrapolation/interpolation is used to calculate the value when reading history variables.

2. Option TITLE is supported
3. *INCLUDE_TRANSFORM: Transformation of units is only supported for RO field and vectors on card 2 and 3.