

Short and long fiber reinforced thermoplastics material models in LS-DYNA

S. Hartmann¹, T. Erhart¹, A. Haufe¹, P. Reithofer², B. Jilka²

¹DYNAmore GmbH

²4a engineering GmbH

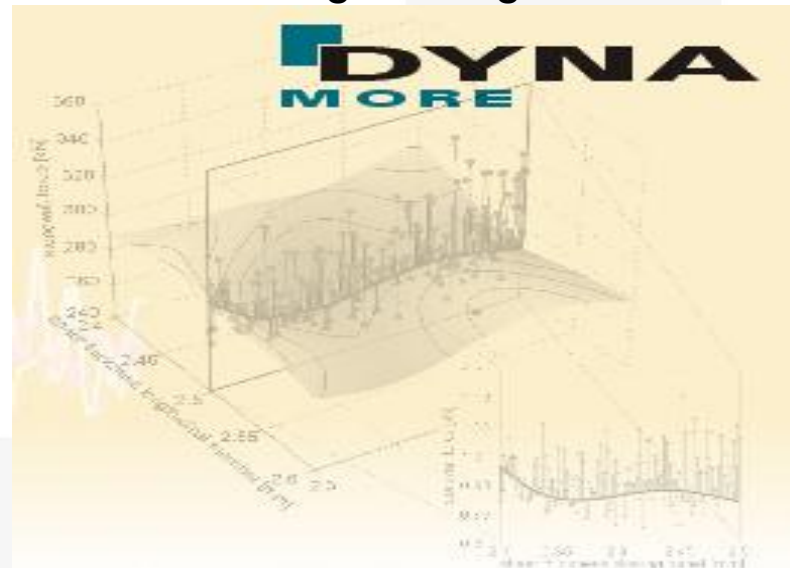

DYNAFORUM 2014
Bamberg

4a engineering GmbH
Industriepark 1
A-8772 Traboch
reithofer@4a.co.at
++43 (0) 664 80106 601

- Introduction
- Exemplary material behavior
fiber orientation and content – strain rate - temperature
- *MAT_24 – typical approach
- Available material models in LS DYNA
- Conclusion

Introduction

Characteristic Structure of reinforced Plastics

Fiber size and geometry have significant influence on the part performance. Orthotropic properties increase with increasing fiber content while at the same time the effect of strain rate diminishes due to the less content of matrix material.

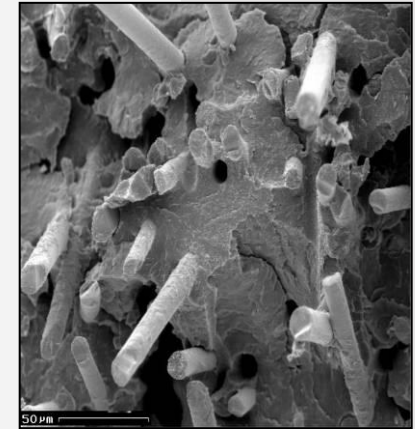
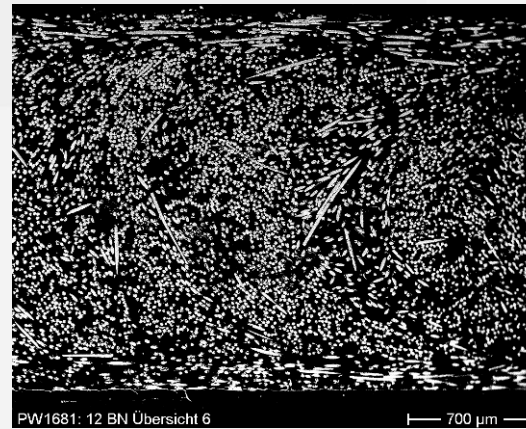

4Q experimental tool
ENGINEERING

plate

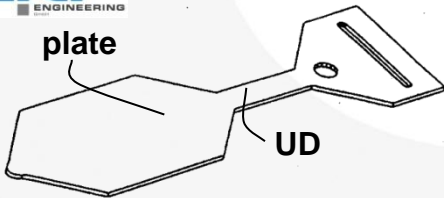

UD



Fiber

dependence on fiber orientation

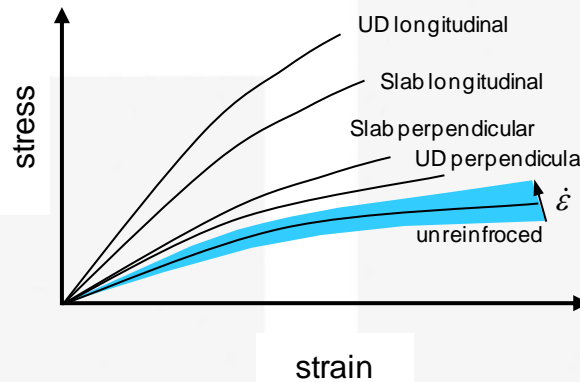

dependence on fiber content

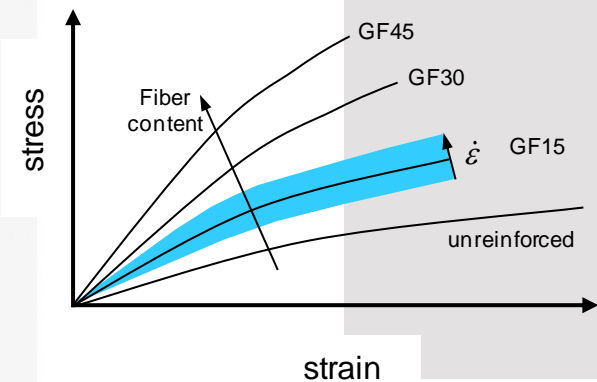

- Celanese has tested three reinforced materials PP GF30, PP GF40 and PP GF50
 - at 3 temperatures
 - at 3 different orientationsby using a quasi static device and 4a impetus device.
- The material behavior of polymers and reinforced polymers depend on many factors such as
 - Temperature
 - Fiber orientation
 - Fiber content
 - Strain rate.

The following slides show exemplary the influence of these factors onto the measurement results of the 3-point-bending test.

fiber reinforced thermoplastics

influence of fiber orientation

PP GF40
3-point-bending at 1 m/s
+23°C

longitudinal
diagonal
perpendicular

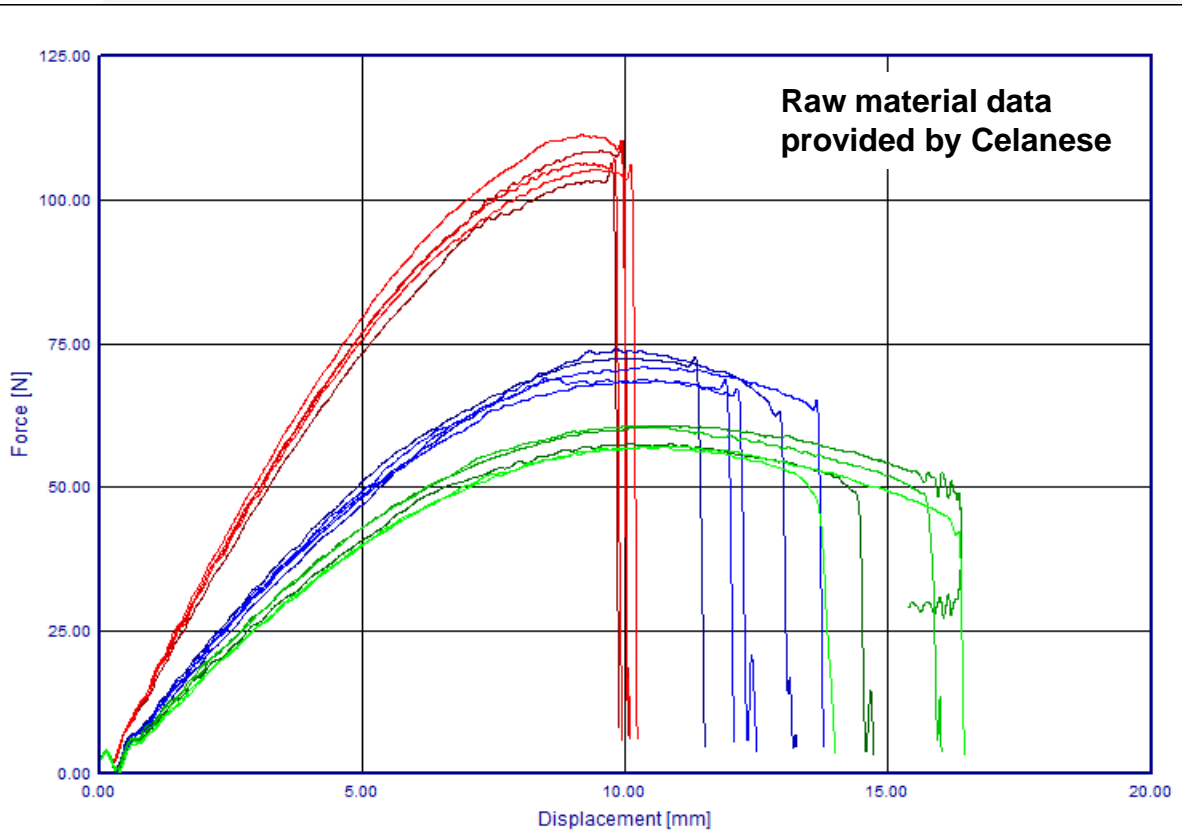
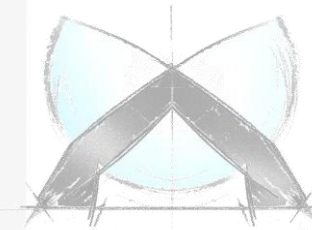

This diagram shows the influence of the fiber orientation of the test specimens. The stiffness for the longitudinal direction is much higher compared to the perpendicular direction and therefore higher forces are needed in the test. The failure displacement increases with the orientation. At 0° orientation failure derives from the fibers while at 90° orientation the failure is dominated by the matrix material (plastics).

fiber reinforced thermoplastics

influence of fiber content

3-point-bending at 1 m/s
+23°C
longitudinal

PP GF50
PP GF40
PP GF30

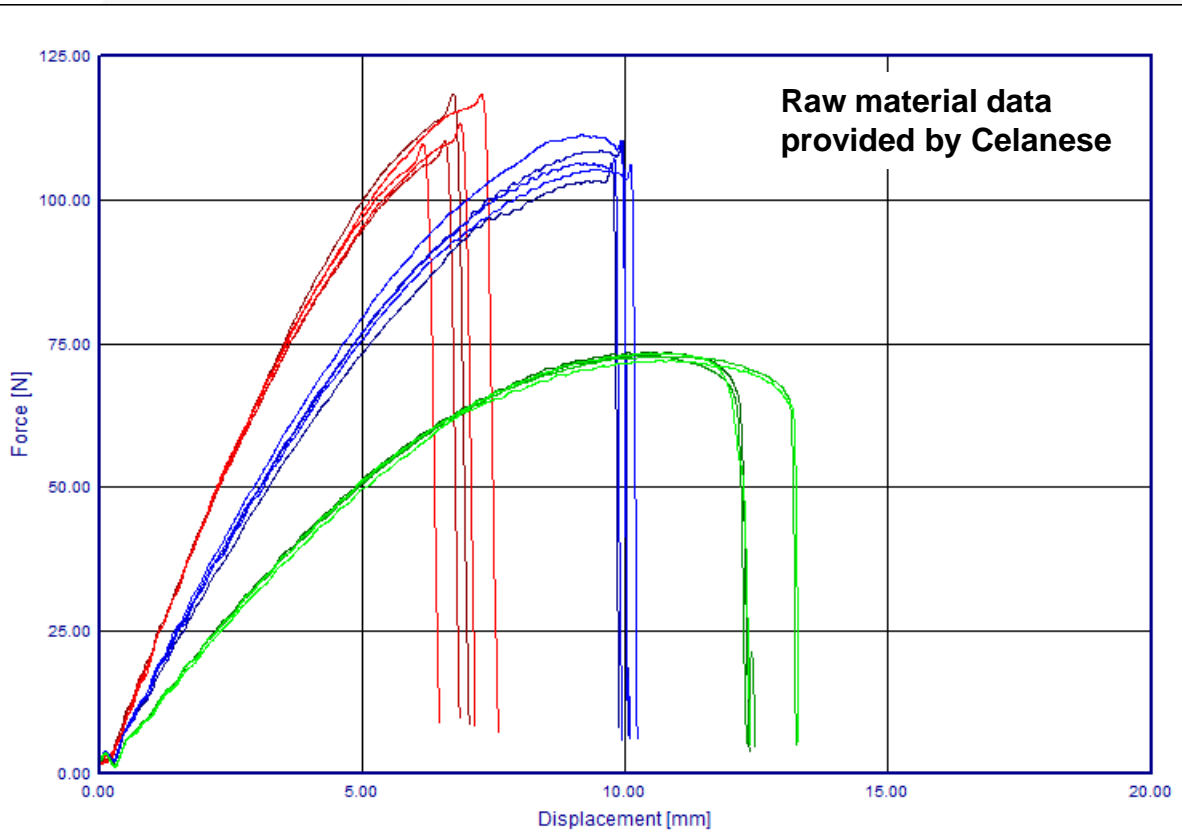
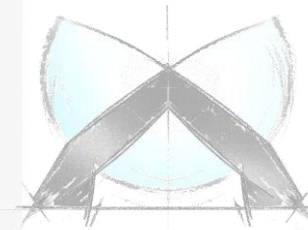

This force-displacement-diagram shows the influence of the fiber content of the test specimens. The more fiber content the higher is the stiffness and the forces in the test. The failure displacement decreases with the fiber content. The reason is the same as for the fiber orientation. Having low fiber content the matrix material dominates failure while at higher amounts of fibers the failure of the fibers leads to failure of the test specimens.

fiber reinforced thermoplastics

influence of strain rate

PP GF40
3-point-bending at 1 m/s
support distance 50 mm
+23°C

longitudinal
1 m/s
0.001 m/s
perpendicular
1 m/s
0.001 m/s

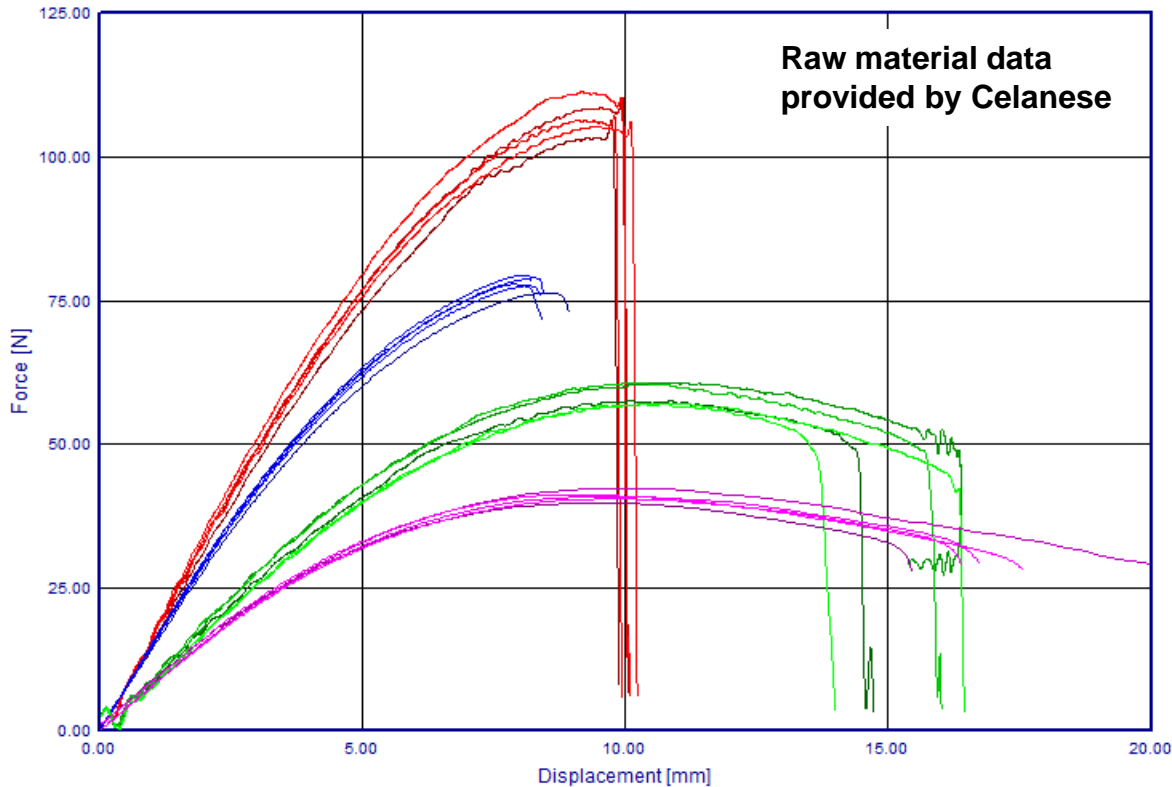

This force-displacement-diagram shows the strain rate dependency of the material. With increasing strain rate the force also increases. For this test setup the dynamic tests at 1m/s have a strain rate that is 1000 times higher than the quasi-static tests at 1 mm/s. Such a strain rate dependency is typical for plastics.

fiber reinforced thermoplastics

influence of temperature

PP GF40 longitudinal
3-point-bending at 1 m/s

-30°C
+23°C
+80°C

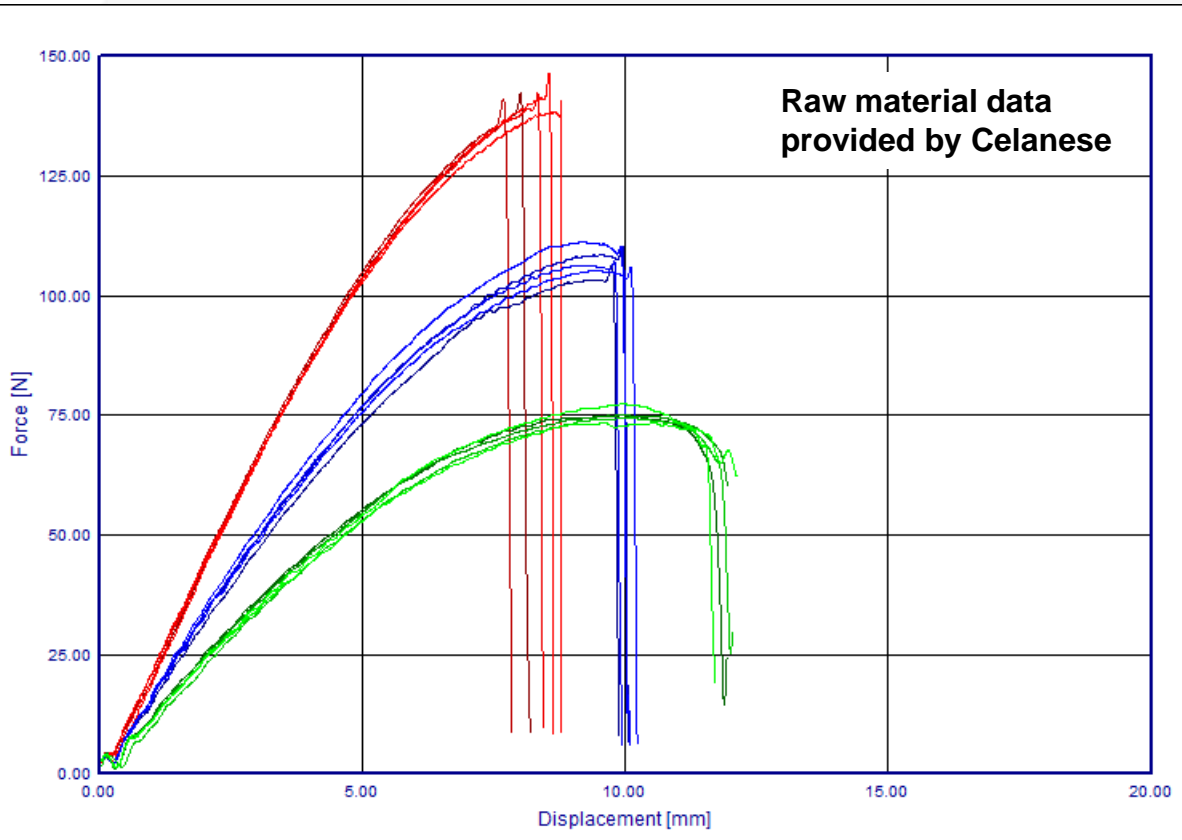
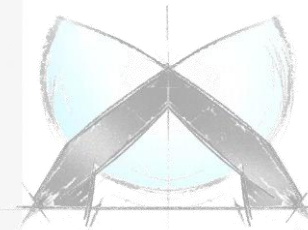

This diagram shows the influence of the temperature of the test specimens. The stiffness decreases with increasing temperature resulting in much higher forces at low temperatures in comparison to higher temperatures. Also the failure displacement decreases with lower temperatures, the test specimens become more brittle.

*MAT_24 – typical approach

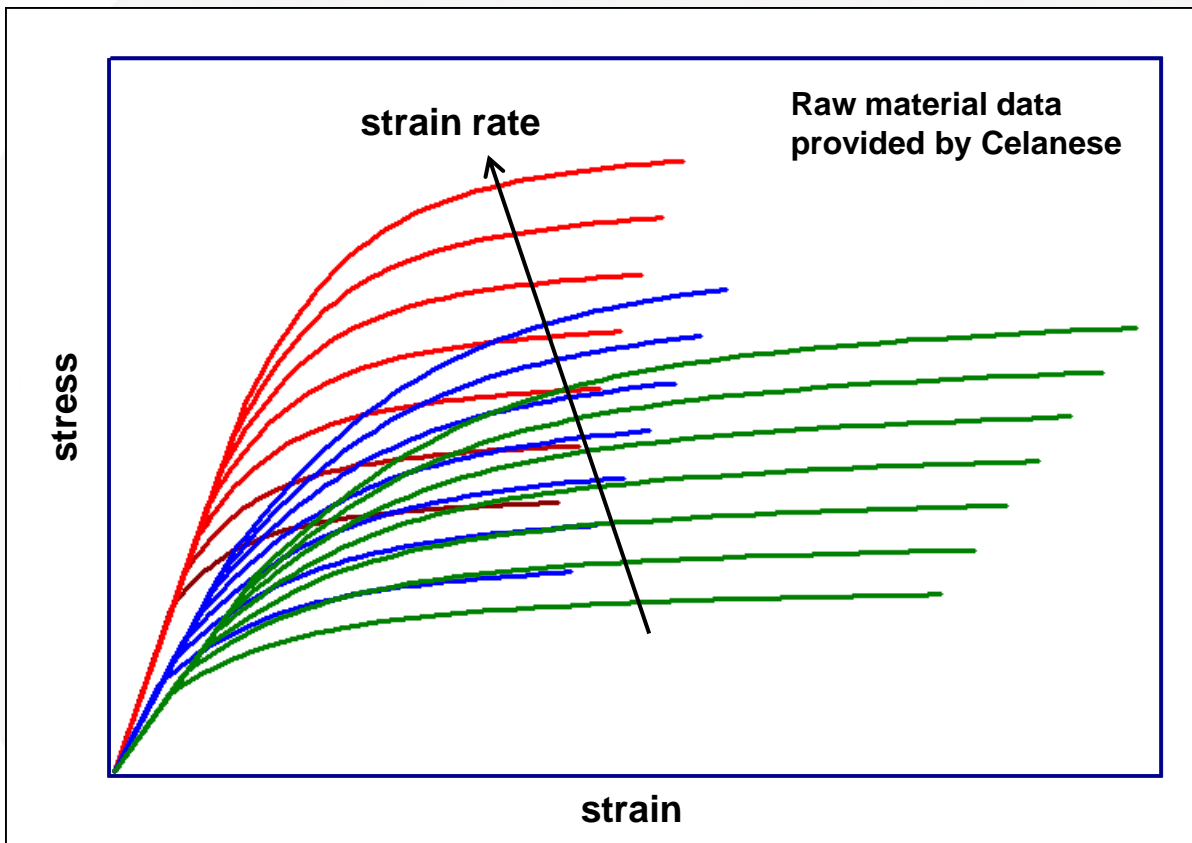

PP GF40

longitudinal
diagonal
perpendicular

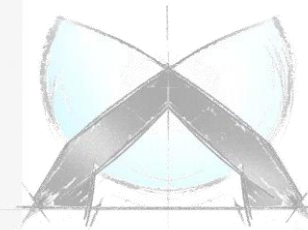

This diagram shows the calculated material models for PP GF40 using *MAT_24. The different Young's Moduli and stress levels for the orientations are clearly visible. The high fiber content leads to quick failure in the tests with just a small amount of plastic strain, especially for the longitudinal direction.

Material models in LSDYNA

Overview

No.	Elastic	Plastic	Damage	Strain rate	Failure
2	Orthotropic / Anisotropic	None	None	None	*MAT_ADD_EROSION
22	Orthotropic	None	None	None	Orientation dependent
54	Orthotropic	None	Elastic Orthotropic	Strength	Orientation dependent
58	Orthotropic	None	Elastic Orthotropic	Strength, Stiffness	Orientation dependent
103	Isotropic	Hill	None	Plasticity	*MAT_ADD_EROSION
108	Orthotropic	Hill	None	None	*MAT_ADD_EROSION
157	Anisotropic	Hill	None	Plasticity	*MAT_ADD_EROSION
158	Orthotropic	None	Elastic Orthotropic	Viscoelasticity	Orientation dependent

Anisotropic **elastic** solution with MAT_002_ANIS

[2014Haufe]



Hyperelastic (total) formulation using Green-Lagrange strain E

$$\boldsymbol{\sigma} = J^{-1} \mathbf{F} \cdot \mathbf{S} \cdot \mathbf{F}^T = J^{-1} \mathbf{F} \cdot \mathbf{C} \cdot \mathbf{E} \cdot \mathbf{F}^T$$

Elastic-anisotropic behavior, stiffness matrix with 21 independent coefficients:

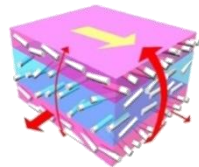
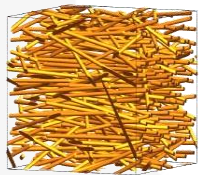

Generation of constitutive data

$$\mathbf{C} = \begin{bmatrix} C_{11} & C_{12} & C_{13} & C_{14} & C_{15} & C_{16} \\ & C_{22} & C_{23} & C_{24} & C_{25} & C_{26} \\ & & C_{33} & C_{34} & C_{35} & C_{36} \\ & & & C_{44} & C_{45} & C_{46} \\ & \text{sym.} & & & C_{55} & C_{56} \\ & & & & & C_{66} \end{bmatrix}$$

Several possibilities to define material directions, e.g. AOPT, ELEMENT_SOLID_ORTHO, ...

Use invariant node numbering is recommended → *CONTROL_ACCURACY: INN=4

No plasticity, no damage, no failure (but: brittle failure possible via *MAT_ADD_EROSION)

Material models in LSDYNA

new features MAT_002

CARD #1	mid	ro	c11	c12	c22	c13	c23	c33
CARD #2	c14	c24	c34	c44	c15	c25	c35	c45
CARD #3	c55	c16	c26	c36	c46	c56	c66	aopt
CARD #4	xp	yp	zp	a1	a2	a3	macf	ihis
CARD #5	v1	v2	v3	d1	d2	d3	beta	ref

[2014Haufe]



➤ C_{ij} : constants in the 6x6 anisotropic constitutive matrix $\sigma_{ij} = C_{ijkl} \epsilon_{kl}$

➤ AOPT: usual options to define the material's coordinate system

➤ ihis: flag for element-wise definition of the stiffness tensor with *INITIAL_STRESS_SOLID. This allows mapping of locally anisotropic data.

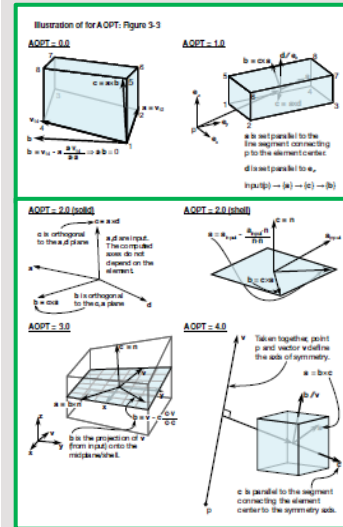

Old approach: each element one material card

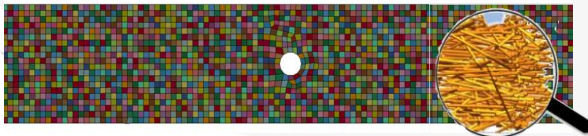

New approach: one property *INITIAL_STRESS_SHELL (SOLID)

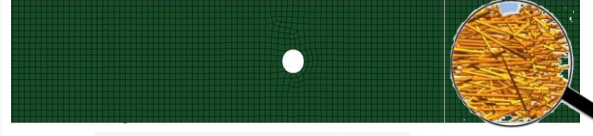

Approaches in literature

➤ **MAT54 + MAT108**

- Spritzgussbauteile aus kurzfaserverstärkten Kunststoffen: Methoden der Charakterisierung und Modellierung zur nichtlinearen Simulation von statischen und crashrelevanten Lastfällen, Julian Schöpfer, Institut für Verbundwerkstoffe GmbH, Dissertation 2011
- Julian Schöpfer: Charakterisierung und Modellierung von kurzfaserverstärkten Kunststoffen - Teil 2: Simulationsmethoden mit LS-DYNA, Dynaforum 2010, Bamberg <http://www.dynamore.de/de/download/papers/forum10/papers/F-IV-03.pdf>

➤ **MAT_157 = MAT_002 + MAT_103**

- André Haufe: Zum aktuellen Stand der Simulation von Kunststoffen mit LS-DYNA, 4a Technologietag 14, http://technologietag.4a.co.at/images/tt2014/s2v3_Haufe.pdf
- R. Jennrich: Experimentelle und numerische Untersuchung eines kurzglasfaserverstärkten Kunststoffes, Dynaforum 2014, Bamberg

IP-wise Initialization

[2014Haufe]



***MAT_157: Selective mapping IHIS**

$$IHIS = a_0 + 2a_1 + 4a_2 + 8a_3$$

FLAG	Description	Variables	#
a_0	Material directions	$q_{11}, q_{12}, q_{13}, q_{31}, q_{32}, q_{33}$	6
a_1	Anisotropic stiffness	C_{ij}	21
a_2	Anisotropic constants	F, G, H, L, M, N	6
a_3	Stress-strain curve	$LCSS$	1

***INITIAL_STRESS_SOLID: NHISV**

- In addition to 6 stress values and eps NHISV history variables can be initialized
- NHISV must correspond to the a_i that define IHIS in *MAT_157

$$NHISV = 6a_0 + 21a_1 + 6a_2 + 1a_3$$

Material models in LSDYNA

simulation process chain

➤ Available simulation process chain for injection molded parts

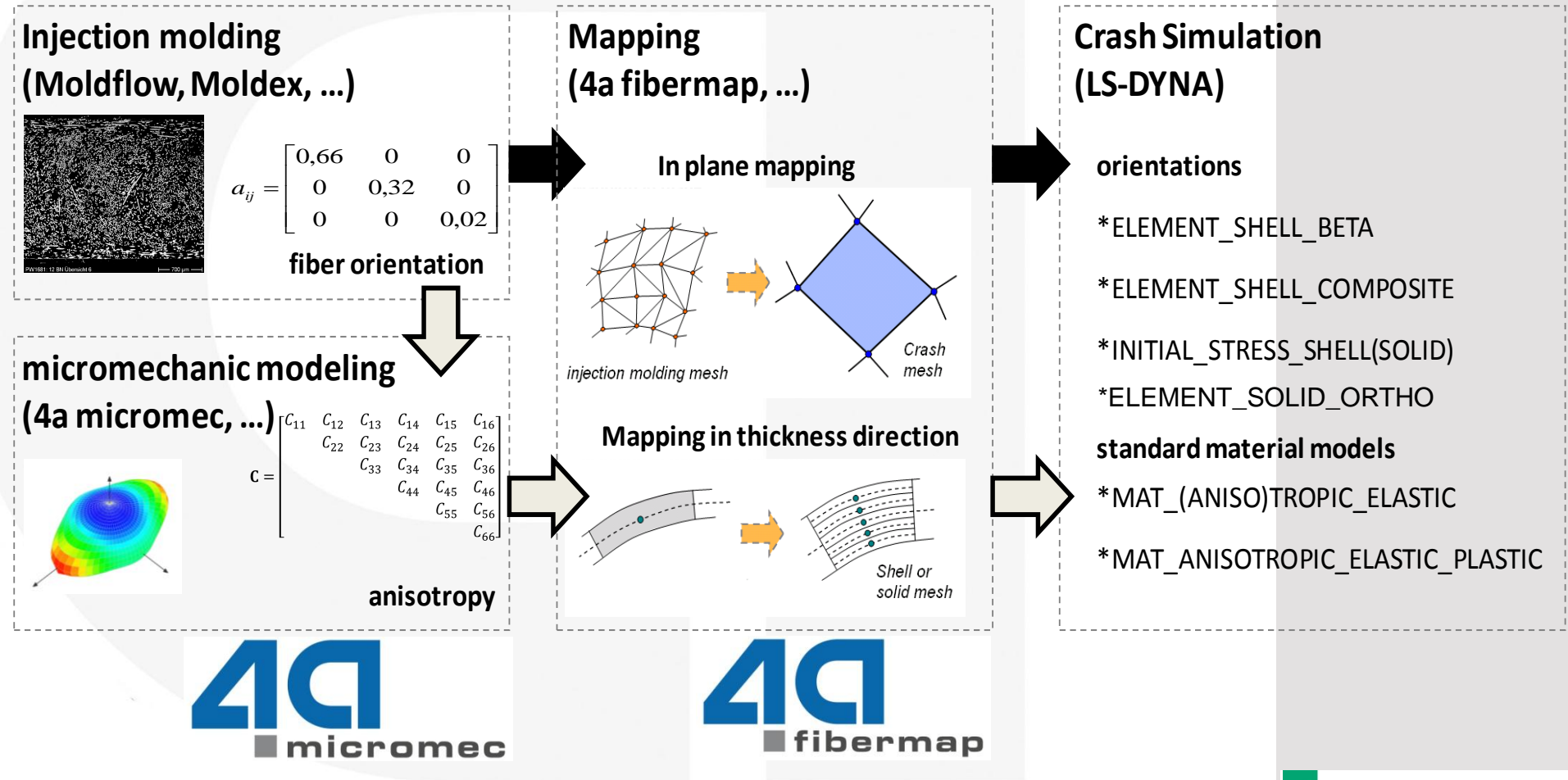

- Available simulation process chain for injection molded parts

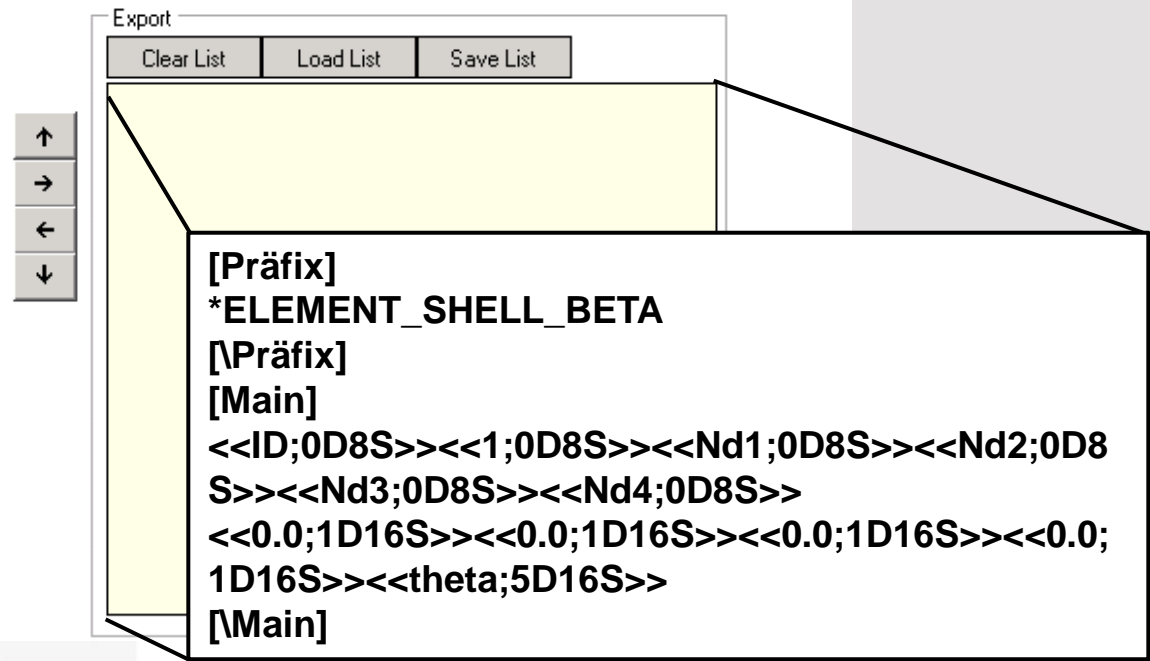
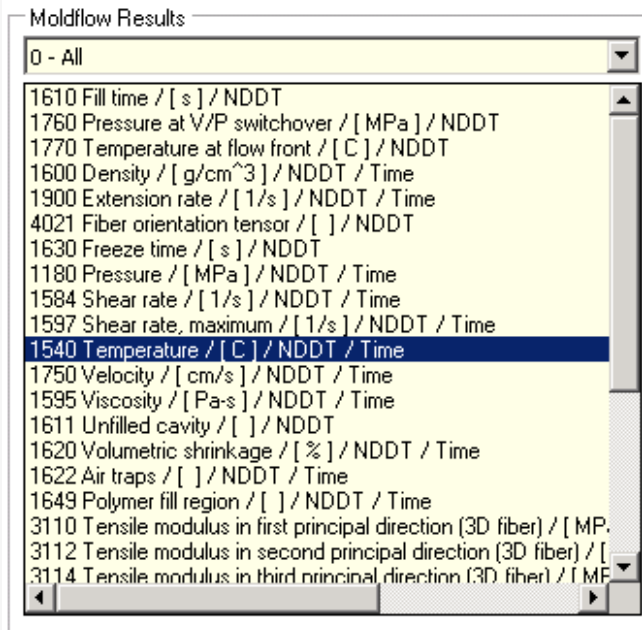

- The influence of the manufacturing process on the material behavior (fiber orientation) is included in the process chain.

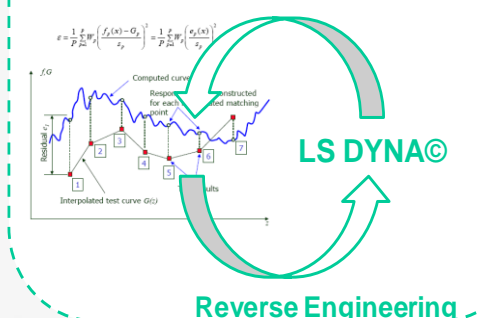
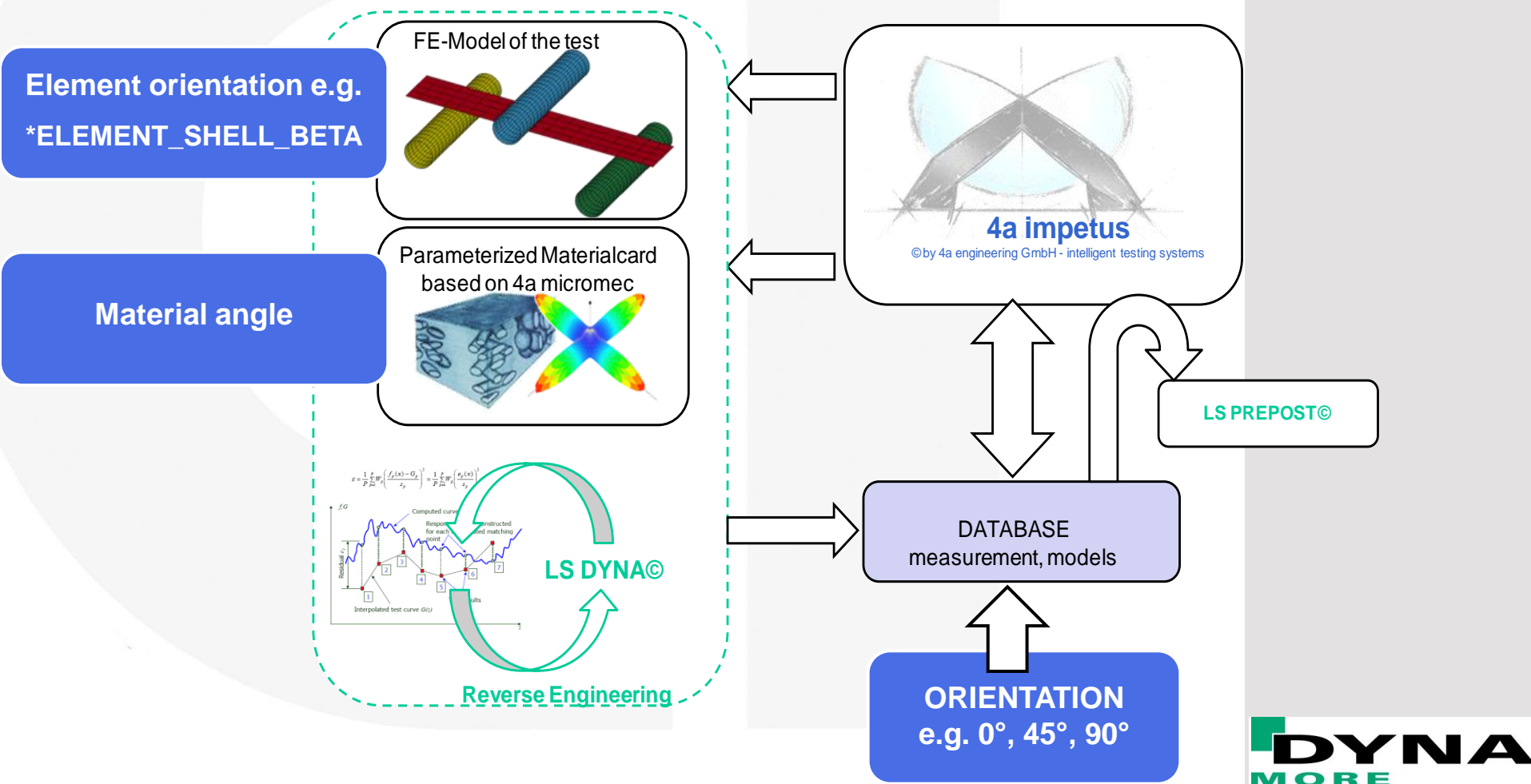

Material models in LSDYNA

Comparison on PPGF40 (MAT_002)

longitudinal

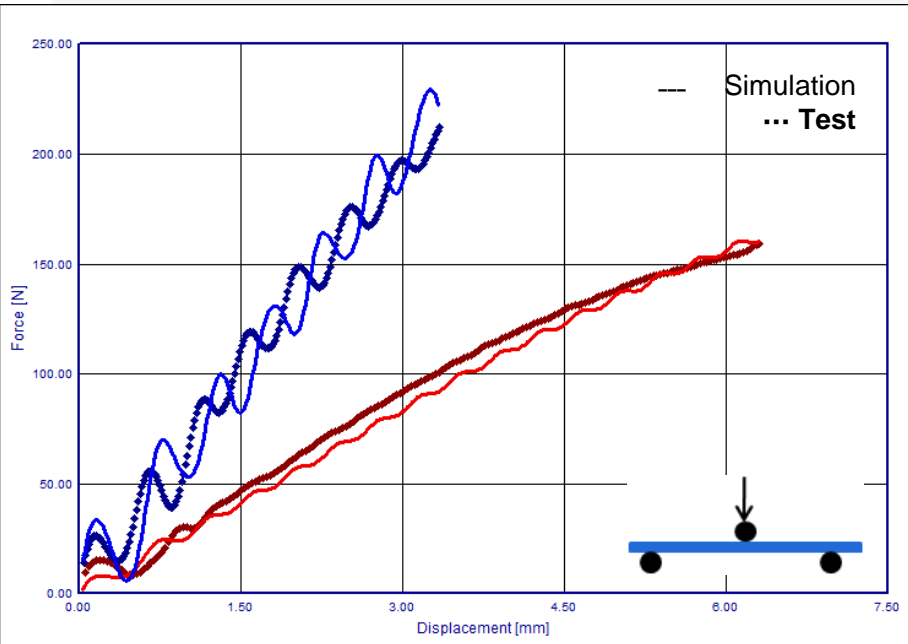

perpendicular

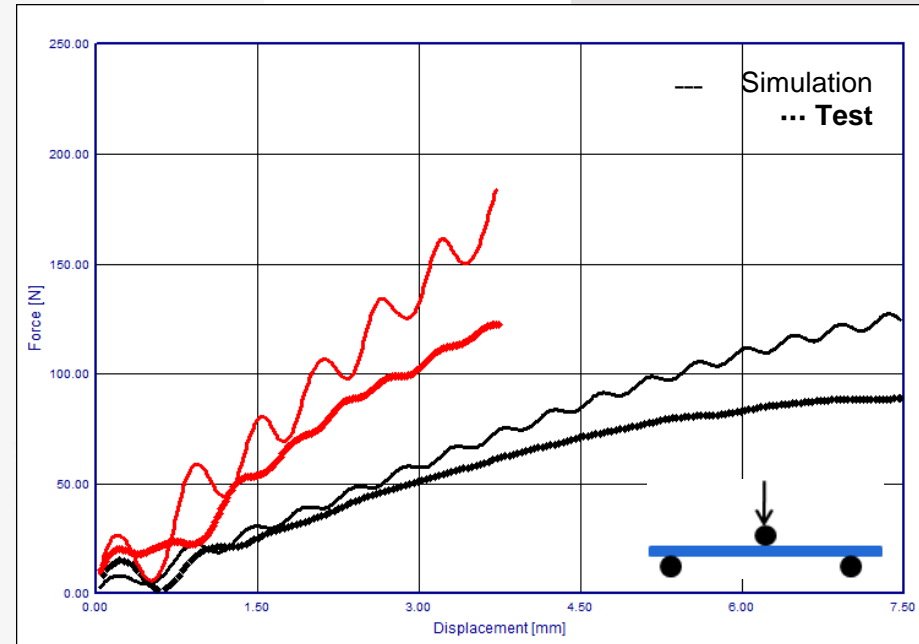

- Orthotropic material models **without plasticity or damage** (MAT_002, MAT_022) can reproduce the **longitudinal direction**, but are too **stiff in perpendicular** direction.

Material models in LSDYNA

Comparison on PPGF40 (MAT_157)

longitudinal

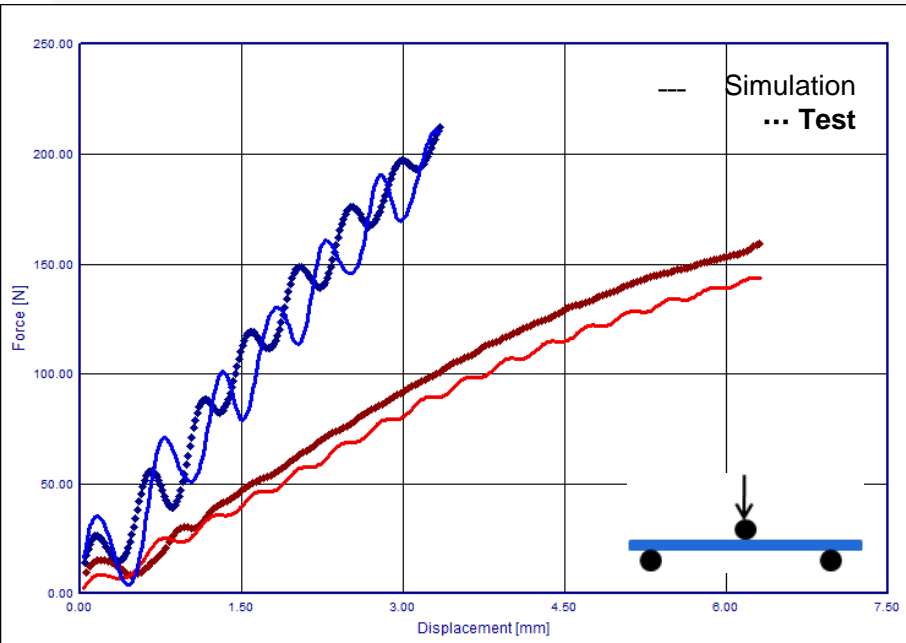

perpendicular

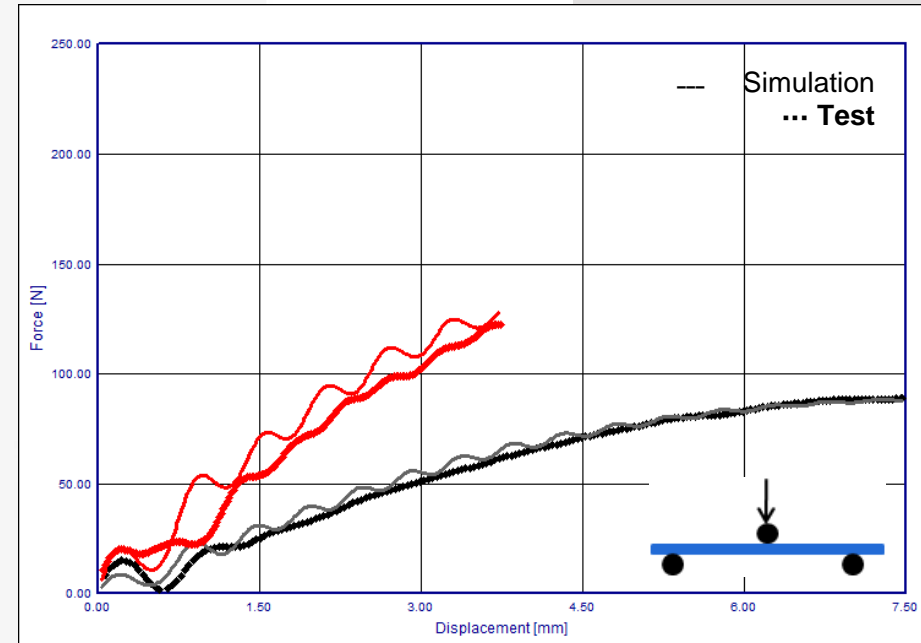

- Orthotropic material models with **plasticity and rate dependence (MAT_157)** can reproduce both directions.

- Orthotropic material models **without plasticity or damage** (MAT_002, MAT_022) can reproduce the **longitudinal direction**, but are too **stiff in perpendicular** direction.
- Orthotropic material models with plasticity (Mat_108) can reproduce both direction but since plastics are rate dependent there is a need to take an average strain rate for the material parameters.
- Orthotropic material models with **plasticity and rate dependence (MAT_157)** can **reproduce both directions**.
- Orthotropic material models with damage (MAT_054, MAT_058, MAT_158) can reproduce both directions. MAT_054 and MAT_058 can have rate dependent damage.
- Outlook: **MAT_058** with **new possibilities** for **strain rate dependent orthotropic elasticity**

Veranstaltungshinweis

Der **4a TECHNOLOGIETAG** findet vom **5.- 6. März 2015** in Schladming zum insgesamt 12. Mal statt.

Das Thema heuer lautet „**Leichtbau und Composites**“.

Nähere Informationen sind demnächst auf der Homepage <http://technologietag.4a.co.at/> verfügbar.

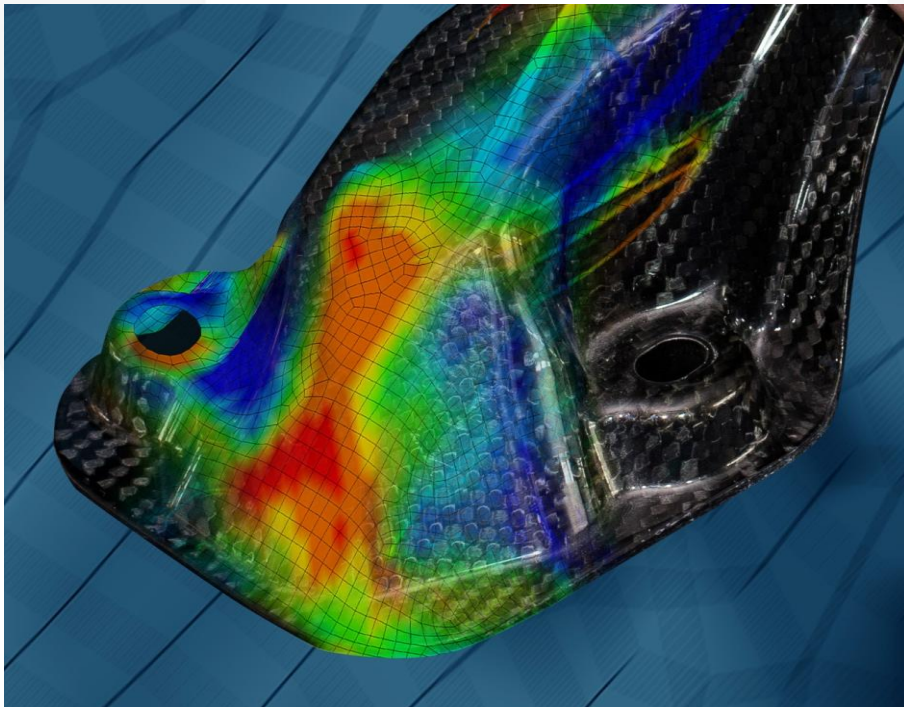

Vielen Dank für die Aufmerksamkeit



- [2008Reithofer]** P. Reithofer, M. Fritz, T. Wimmer (4a engineering GmbH) – *Kurzfaserverstärkte Kunststoffbauteile - Einfluss der prozessbedingten Faserorientierung auf die Strukturmechanik*, 7. LS-DYNA Anwenderforum, Bamberg 2008 ([Link](#))
- [2012Reithofer]** P. Reithofer, B. Jilka, A. Fertschej (4a engineering GmbH) – *4a micromec für die integrative Simulation faserverstärkter Kunststoffe*, 11. LS-DYNA Anwenderforum, Ulm 2012 ([Link](#))
- [2014Haufe]** A. Haufe (DYNAmore GmbH) – *Zum aktuellen Stand der Simulation von Kunststoffen mit LS-DYNA*, 11. 4a Technologietag - 2014 ([Link](#))
- [2014Jennrich]** R. Jennrich, M. Roth, Prof. S. Kolling (Technische Hochschule Mittelhessen) C. Liebold (DYNAmore GmbH), G. Weber (Celanese GmbH) – *Experimentelle und numerische Untersuchung eines kurzglasfaserverstärkten Kunststoffes*, 13. LS-DYNA Forum 2014, Bamberg ([Link](#))