

## Engineering Analysis with Finite Elements – LS-DYNA<sup>®</sup> for Undergraduate Students

John D. Reid

*Department of Mechanical & Materials Engineering  
University of Nebraska-Lincoln  
W342 NH (0526), Lincoln, NE 68588 USA*

### Abstract

*A typical college course in finite elements consists of learning the method in continuum mechanics (transient heat conduction and elastic stress analysis), from formulation of the governing equations to implementation in some software (such as Fortran or Matlab). This class is not such a course. Instead, this class concentrates on analyzing engineering systems; a challenging task regularly done by design engineers. Finite elements is the tool of choice for performing such analysis for many, many applications and corporations. Structural stress, heat transfer, fluid flow, and modal analysis are quite distinct from each other but can all be treated successfully with finite elements. Of course, some basic principles of the finite element method is required, as well as understanding of behavior, sensitivity and robustness relative to mesh density, boundary conditions, material properties and other influential parameters. But the emphasis is on the engineering analysis itself, not the tool. LS-DYNA is well suited for this endeavor because of its' multi-physics capabilities.*

### Introduction

“Is it live or is it Memorix?” It is not the goal of Universities to teach engineering students how to run software. However, shortly after receiving a B.S. degree many engineers have jobs that require using highly sophisticated finite element analysis (FEA) software on a regular basis. If the engineer is not properly prepared they will not be able to answer the question: “Is it physics or is it a cartoon?” This can lead to catastrophic results, both financially and personal safety.

Undergraduate Mechanical Engineering majors at the University of Nebraska-Lincoln (UNL), and other Universities, based on multiple visits to bookstores at other Universities and on-line searches, take a considerable amount of fundamental courses that have little or no mention of FEA. As examples, books for system dynamics [1], fluid mechanics [2] and heat transfer [3] at UNL are well-known and have a long history, but have minimal discussion on FEA.

On the “other-side,” finite element courses tend to be dominantly a learning experience in the mathematics behind FEA and how to write FEA code using Fortran or Matlab. As an example, the Intro to FE course at UNL uses the wonderful book by Fish and Belytschko [4]. This book does include some usage of Abaqus but not in any significant way for the practicing engineering. It is well suited for learning fundamentals and for someone interested in pursuing a career in FEA software development.

It is the belief of this author that many mechanical engineering students would greatly benefit from a course that bridges the gap between fundamental engineering courses and finite element courses. Such a course has been developed at UNL and has now been offered twice within the past three years. The title of the course conveys the objective of the course, that being “Engineering Analysis with Finite Elements.”

After reviewing dozens of textbooks, the author found one textbook that seems to embrace this concept [5] and one that has the general idea but is limited to stress analysis [6]. The former book was used as reference material for this class, but not as a required book.

LS-DYNA was the code chosen for this course because of its’ multi-physics capabilities in a single code. This makes transitioning from one domain to another domain for solving various engineering analysis problems relatively straight forward. The pre- and post-processor LS-PrePost was used by the students. A huge advantage of using LS-PrePost is its’ ability to run on almost all computers the students had access to (including their own), and its’ non-license fee policy.

### **Engineering Analysis – The Process**

Throughout the semester, an engineering analysis process was frequently discussed and expanded upon. The philosophy of “start simple, add complexity” was followed as much as possible and to most of the topics covered in the course. As an example, the initial engineering analysis process was rather simple with just a few details discussed, as shown in Table 1. As various topics were detailed, the analysis process table was expanded so that students could see how new material fit in the overall complex process. An example of the process later in the semester is shown in Table 2.

**Table 1. An Engineering Analysis Process - Initial**

<ol style="list-style-type: none"><li>1. Understanding the engineering problem.</li><li>2. Understanding the solution technique.</li><li>3. Understand the results.</li><li>4. What to do with that understanding.</li></ol>
--

Although each topic listed in Table 2 was covered more than once, particular details were presented at the appropriate time and distributed amongst the four domains covered (structural analysis, heat transfer, fluid flow, and modal analysis). That statement is explained by way of the following subsections.

#### **Week 2 – Structural Analysis – 2.a. The Finite Element Method**

After reviewing the governing differential equations for plane stress (review from elastic bodies course), the finite element method is detailed and applied for a constant strain/stress triangular element. This results in the expansion of item 2.a. in Table 2 as listed in Table 3.

**Table 2. An Engineering Analysis Process – Details Emerging**

<ol style="list-style-type: none"><li>1. Understanding the engineering problem.<ol style="list-style-type: none"><li>a. The physical problem</li><li>b. Ideas of expected behavior (cartoon – physics)</li><li>c. Governing differential equations</li></ol></li><li>2. Understanding the solution technique.<ol style="list-style-type: none"><li>a. The finite element method</li><li>b. The finite element model</li><li>c. Numerical integration</li></ol></li><li>3. Understand the results.<ol style="list-style-type: none"><li>a. Post-processing</li></ol></li><li>4. What to do with that understanding.<ol style="list-style-type: none"><li>a. Influence the design</li><li>b. Communicate – papers, reports, presentations</li></ol></li></ol>
---

**Table 3. An Engineering Analysis Process – The Finite Element Method**

<ol style="list-style-type: none"><li>2.a. The finite element method<ol style="list-style-type: none"><li>i. Discretize and select element type</li><li>ii. Select a displacement function</li><li>iii. Define strain-displacement relationship and stress-strain relationship</li><li>iv. Derive the (finite) element equations<ol style="list-style-type: none"><li>1. Direct equilibrium method</li><li>2. Work/energy methods<ol style="list-style-type: none"><li>a. Principal of virtual work</li><li>b. Principal of minimum potential energy</li><li>c. Castigliano's theorem</li></ol></li><li>3. Weighted residuals methods (e.g., Galerkin's)</li></ol></li><li>v. Assemble the global equations and introduce loads/boundary conditions</li><li>vi. Solve for the unknown displacements</li><li>vii. Solve for stresses and strains</li></ol></li></ol>
---

**Week 6 – Heat Transfer – 2.c. Numerical Integration**

By this time in the class the students have already simulated several models, but certain critical items were handled for them using templates or pre-defined models. One such item is numerical integration.

Twenty years ago most mechanical engineering students had a course in numerical techniques, today such courses are rare and often exist as senior elective courses only.

In LS-Dyna the default numerical integration scheme for structural analysis is explicit integration, while heat transfer analysis uses an implicit method. Integration schemes, and most importantly, the appropriate time step, must be understood (as well as used correctly, if one wants to get an accurate solution). Thus, considerable time is spent on numerical integration at this point in the class. This proves to be very useful when students begin simulating structural-thermal problems where two different time steps within the simulation are being considered. An explicit time step for the structural analysis and an implicit time step for the thermal analysis. The thermal time step is often an order of magnitude larger than the structural time step.

**Week 11 – Fluid Flow – 1.c. Governing Differential Equations**

Although the basic governing differential equations for plane stress had already been reviewed, it seemed appropriate to dive into equations further during the fluid analysis section. Specifically, the ever intimidating conservation of mass, momentum and energy equations, along with the material constitutive equations. Another example of start simple, add complexity. Of course, the semester is too far along for the students to drop the course at this point, so we have them were we want them for making things as difficult as possible.

The remainder of this paper provides examples of engineering analysis covered in the course.

## Structural Stress Analysis

Hook bolts are used in many applications, such as hanging plants from ceilings, bicycles in garages, and pull-up bars in basements. They can be analyzed in 2-D and provide a chance to verify accuracy with free body diagrams at various locations calculating forces and moments. Those calculations can be compared to cross section analysis in LS-Dyna. Such a model is good for simple mesh sensitivity studies and experiencing loading difficulties in FEA (i.e., point loading versus distributed loading). Determining loads that cause plastic deformations can also be studied quite effectively. The idea for this example came from reference [5].

Bolted joints, although not all that glamorous, are extremely common and require due diligence for a proper connection. Preloading (i.e., pre-stressing) a bolted joint is a critical factor in the effectiveness of a joint under loading conditions, particularly those with cyclical and/or dynamic loads.

Since this topic is covered early in the class, models are provided for the students and their concentrated efforts are on performing parameters studies, learning a multitude of post-processing techniques, performing hand calculations, and comparing theory versus simulation. Results of two of the studies are shown in Figures 1 and 2.

In regards to post-process, the amount of information available from FEA is often quite amazing to students, instead of the typical 1 or 2 calculated values, they get dozens of different types of output to examine. This greatly enhances their analysis capabilities.

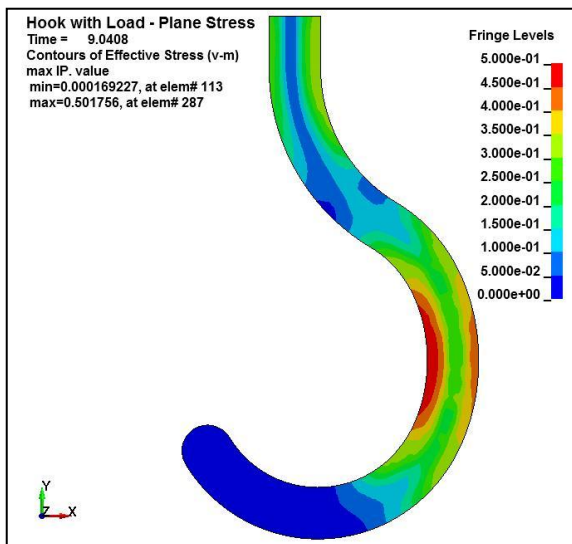

Figure 1. Hook Bolt Stress

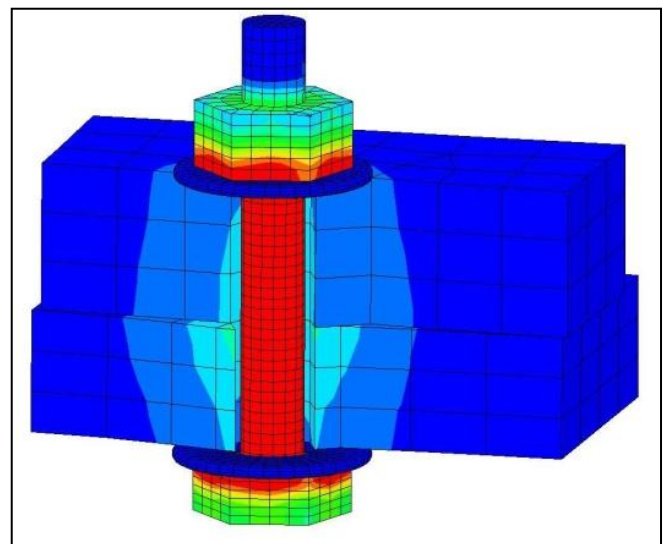
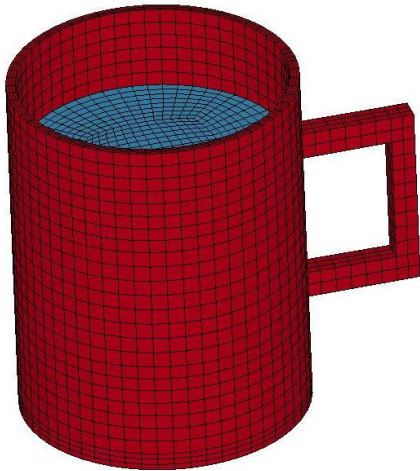

Figure 2. Pre-stressed Bolted Joint

## Heat Transfer

Heat transfer was presented primarily using a reduced and modified version of Art Shapiro's (LSTC) wonderful course notes "LS-DYNA for Heat Transfer & Coupled Thermal-Stress Problems." Starting with simple one element models for adiabatic heating and thermal expansion of an aluminum block and increasing complexity until a coupled thermal-stress-fluids multi-physics simulation of an injection molding process is investigated.

A coffee mug thermal analysis project was undertaken by the class.



**Figure 3. Coffee Cup**

### Project Description

Investigate a finite element model of a cup filled with coffee, shown in Figure 3. Examples of physical things to investigate: Determine how long it takes for the coffee to cool down. Does the cup or handle get dangerously hot for someone holding it? Parameter study: Change the cup's material properties from ceramic to something else (e.g. glass, plastic, stainless steel).

To get a grade higher than a "B" you must investigate one or more different shapes for the cup and compare to the baseline cylindrical shape.

Results from Matt Camacho-Cook and Luke Oswald are presented here. The model is 3D but the favorite temperature fringe plots were side views with half the model blanked in order to visualize the coffee and mug temperature distribution, as shown in Figures 4 and 5.

This problem included conduction, convection and thermal-contacts. While working the project, students asked many insightful questions, most of which can be summarized with the following two: (1) The convection boundary condition in the model seems insufficient to capture the cooling process. How do you model the evaporation and steam? (2) The internal coffee cooling seems more complicated than simple conduction. How do you add the "swirling" effect (not sure what to call it) - hot portion rises, cold portion falls?

Upon relating this to Art, he responded with:

"WOW! My coffee cup may turn into a multi-disciplinary problem. Heat transfer (conduction, convection, radiation) + mass transfer (evaporation) + momentum transfer (hot fluid rising)."

Such questions indicate the students interest in the course, and their ability to analyze the situation and begin the process of distinguishing cartoons from physics.

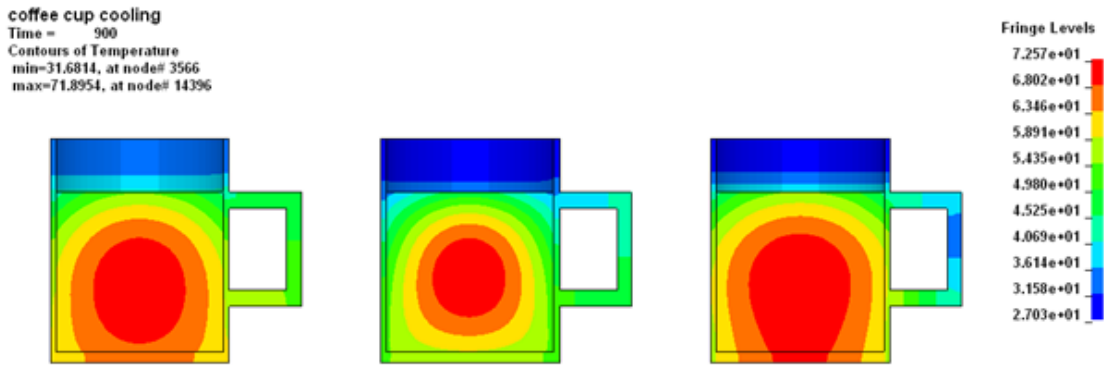

Figure 4. Temperature Profiles at 900 Seconds: Different Cup Materials

Table 4. Material Thermal Properties

Material	Thermal Density [kg/m <sup>3</sup> ]	Heat Capacity [J/kgC]	Thermal Conductivity [W/mC]
Ceramic	2220	728	4
AISI 304 SS	7900	515	16.6
Pyrex	2225	835	1.4

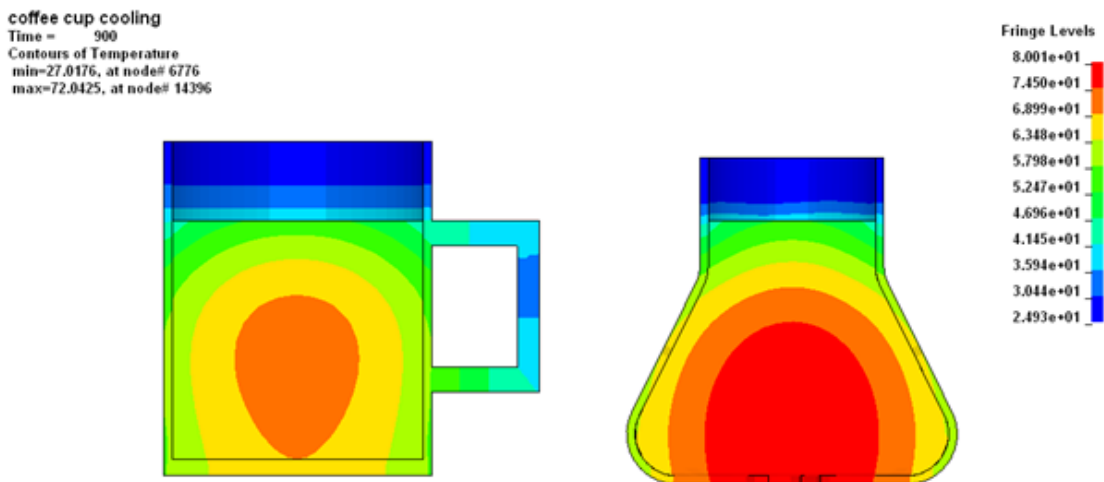

Figure 5. Temperature Profiles at 900 Seconds: Original and Redesigned Mug

## Fluid Flow

With help from M'Hamed Souli (LSTC consultant, former employee), course notes were developed for this portion of the class as a compilation, reduction and modification of many fluids notes used in various LSTC classes on fluid analysis. Time is spent discussing high deformations, and the capabilities and limits of Lagrangian, Eulerian and Arbitrary-Lagrangian-Eulerian (ALE) methods for fluid analysis.

The fluid portion starts simple with fluid flow through a straight channel. After learning (actually re-learning from their Fluids Mechanics class) about that phenomena, the students are given an assignment to analyze a more complicated channel of their own choosing. The beginning of the analysis starts with developing a baseline model. As an example, the description of the baseline model from Ray Julin and Jeff Middy's report starts as follows.

*“A model of fluid flow through a channel of arbitrary geometry is analyzed. A square corner, U-shape channel will be examined. This shape was selected so an interesting, non-uniform flow pattern can be seen. The inlet velocity profile, equal to that of the in-class example, and the steady-state velocity profile throughout the channel can be seen in Figure 1. The steady-state plot shows a higher velocity in the narrow section of the channel, and a very low velocity in the sharp, outside corners. These results are expected, and validate the model is working correctly.”*

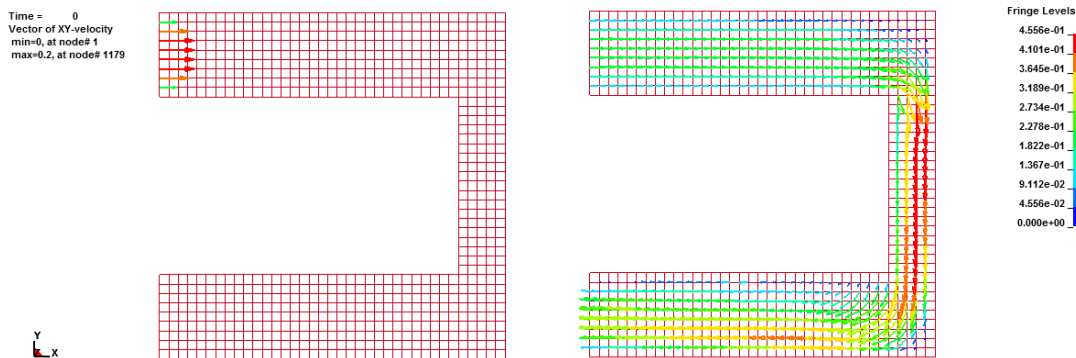

**Figure 6. Baseline Model: Velocity Vectors Initially (left) and at Steady-state (right)**

The model by Julin/Middy is nice for some practical applications and developing better understanding of the fluid flow in channels. Some students were a little more creative in their models, as shown in Figure 7 (model developed by Ryan Moore and Kyle Phillips). The in-flow channels might appear a little strange, they are added and defined as ambient (reservoir) in order to make the in-flow smoother (essentially).



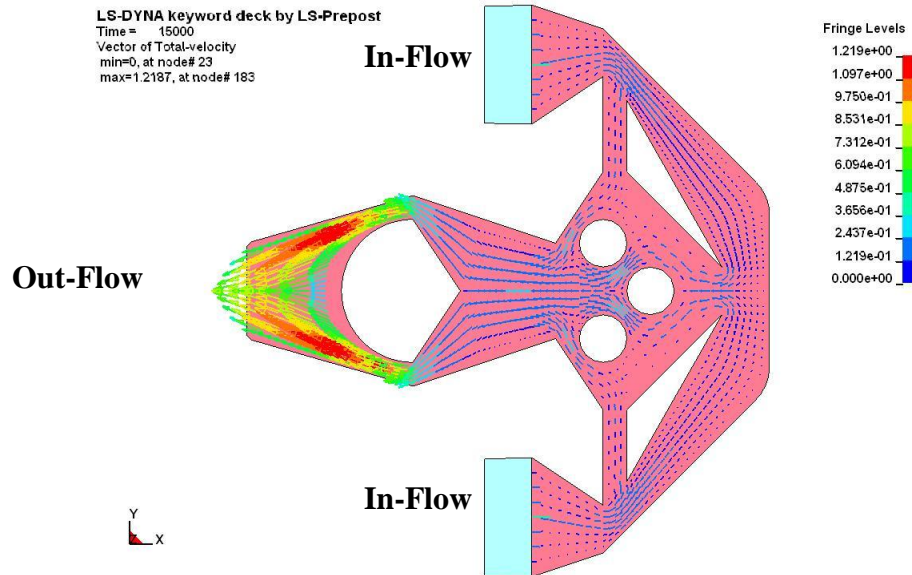

**Figure 7. Velocity Vectors for Baseline Fluid Flow**

As the investigation into fluid analysis increased in complexity, a model of a projectile (Langrangian) moving through water (Eulerian) subjected to an explosion occurring in the water was studied. The concept is to protect something underwater by exploding anything that attempts to come near it. Of course, it is not good if the explosive protection device also destroys the structure being protected. Although the model itself is rather crude, many students like the idea of exploding stuff and thus, there is high interest.

## **Modal Analysis**

As the semester begins to wind down, we switch to a drastically different topic, that being, modal analysis. Since Mechanical Engineers are often not required to take a course in vibrations, their knowledge of modal analysis is very limited. As in, they know what natural frequencies are and if pressed could determine them for some simple mass-spring systems. Thus, a little education on eigenvalues and eigenvectors, and of course mode shapes is in order.

This turns out to be fairly light and easy for the students but very intriguing as we quickly demonstrate the first 40 to 80 mode shapes of a complete vehicle. More practical applications are also discussed. Like the mode shapes of a body-in-white from a passenger car or of a frame from a truck, discussing how the torsional stiffness of a vehicle is analyzed by such methods.

Obtaining eigenvalues and such out of LS-Dyna is quick and easy. LS-PrePost can animate the mode shapes with very little effort. The time consuming part is in generating a finite element model of the system you want to analyze. The hard part is that double-precision implicit LS-Dyna should be used. Not that that is terribly difficult in itself, it just adds more complexity and details required for the students who, at this point, find themselves with zillions of little details to keep track of if they hope to apply FEA successfully in any domain, let alone multi-domain physics. Engineering analysis with finite elements is not for the uneducated.

## **Conclusions**

The following items gum up the whole process.

### **Computer & Environment**

- mpp & smp
- running, controlling jobs (sge, maui)
- unix & windows
- communications (telnet, ftp)

### **Execution**

- time step
- explicit & implicit
- single-precision & double-precision

### **Model Generation**

- CAD
- meshing
- pre-processing software

### **Shotgun or Ordered Chaos**

- demos, derivations, powerpoint, theory, examples, multi-media
- homework, in-class labs, projects, tests, quizzes, literature reviews
- individual assignments, with partners

## **Acknowledgments**

The author greatly appreciates all the help from many LSTC employees, particularly John Hallquist, Morten Jensen, Art Shapiro, M'Hamed Souli, Philip Ho and Jacob Krebs who all aided in this course development. The author also acknowledges the staff and students of the Midwest Roadside Safety Facility for their support. And, of course, the students taking the class. The simulation work performed for this course was completed utilizing the Holland Computing Center of the University of Nebraska–Lincoln.

## **References**

1. Close, Frederick and Newell, *Modeling and Analysis of Dynamic Systems*, 3<sup>rd</sup> Edition, Wiley, 2002.
2. White, *Fluid Mechanics*, 7<sup>th</sup> Edition, McGraw-Hill, 2011.
3. Bergman, Lavine, Incropera and Dewitt, *Introduction to Heat Transfer*, 6<sup>th</sup> Edition, Wiley, 2011.
4. Fish and Belytschko, *A First Course in Finite Elements*, Wiley, 2007.
5. Dechaumphai and Phongthanapanich, *Easy Finite Element Method*, Alpha Science, 2009.
6. MacDonald, *Practical Stress Analysis with Finite Elements*, Glasnevin Publishing, 2007.

