

**LS-DYNA<sup>®</sup>**  
**KEYWORD USER'S MANUAL**

**VOLUME II**  
**Material Models**

**March 26, 2012 (revision: 1275)**

**Version 971**

**LIVERMORE SOFTWARE TECHNOLOGY CORPORATION (LSTC)**

## Corporate Address

Livermore Software Technology Corporation  
P. O. Box 712  
Livermore, California 94551-0712

## Support Addresses

Livermore Software Technology Corporation  
7374 Las Positas Road  
Livermore, California 94551  
Tel: 925-449-2500 ♦ Fax: 925-449-2507

**Email:** [sales@lstc.com](mailto:sales@lstc.com)

**Website:** [www.lstc.com](http://www.lstc.com)

Livermore Software Technology Corporation  
1740 West Big Beaver Road  
Suite 100  
Troy, Michigan 48084  
Tel: 248-649-4728 ♦ Fax: 248-649-6328

## Disclaimer

Copyright © 1992-2012 Livermore Software Technology Corporation. All Rights Reserved.

LS-DYNA®, LS-OPT® and LS-PrePost® are registered trademarks of Livermore Software Technology Corporation in the United States. All other trademarks, product names and brand names belong to their respective owners.

LSTC reserves the right to modify the material contained within this manual without prior notice.

The information and examples included herein are for illustrative purposes only and are not intended to be exhaustive or all-inclusive. LSTC assumes no liability or responsibility whatsoever for any direct or indirect damages or inaccuracies of any type or nature that could be deemed to have resulted from the use of this manual.

Any reproduction, in whole or in part, of this manual is prohibited without the prior written approval of LSTC. All requests to reproduce the contents hereof should be sent to [sales@lstc.com](mailto:sales@lstc.com).

---

AES

Copyright © 2001, Dr Brian Gladman <[brg@gladman.uk.net](mailto:brg@gladman.uk.net)>, Worcester, UK. All rights reserved.

## LICENSE TERMS

The free distribution and use of this software in both source and binary form is allowed (with or without changes) provided that:

1. distributions of this source code include the above copyright notice, this list of conditions and the following disclaimer;
2. distributions in binary form include the above copyright notice, this list of conditions and the following disclaimer in the documentation and/or other associated materials;
3. the copyright holder's name is not used to endorse products built using this software without specific written permission.

## DISCLAIMER

This software is provided 'as is' with no explicit or implied warranties in respect of any properties, including, but not limited to, correctness and fitness for purpose.

---

Issue Date: 21/01/2002

This file contains the code for implementing the key schedule for AES (Rijndael) for block and key sizes of 16, 24, and 32 bytes.

# TABLE OF CONTENTS

## TABLE OF CONTENTS

*MAT.....	1
MATERIAL MODEL REFERENCE TABLES.....	8
*MAT_ADD_AIRBAG_POROSITY_LEAKAGE.....	16
*MAT_ADD_EROSION.....	18
*MAT_ADD_PERMEABILITY.....	32
*MAT_ADD_PORE_AIR.....	33
*MAT_ADD_THERMAL_EXPANSION.....	35
*MAT_NONLOCAL.....	37
*MAT_ELASTIC_{OPTION}.....	41
*MAT_{OPTION}TROPIC_ELASTIC.....	44
*MAT_PLASTIC_KINEMATIC.....	52
*MAT_ELASTIC_PLASTIC_THERMAL.....	55
*MAT_SOIL_AND_FOAM.....	58
*MAT_VISCOELASTIC.....	63
*MAT_BLATZ-KO_RUBBER.....	65
*MAT_HIGH_EXPLOSIVE_BURN.....	66
*MAT_NULL.....	69
*MAT_ELASTIC_PLASTIC_HYDRO_{OPTION}.....	71
*MAT_STEINBERG.....	76
*MAT_STEINBERG_LUND.....	81
*MAT_ISOTROPIC_ELASTIC_PLASTIC.....	85
*MAT_ISOTROPIC_ELASTIC_FAILURE.....	86
*MAT_SOIL_AND_FOAM_FAILURE.....	88
*MAT_JOHNSON_COOK.....	89
*MAT_PSEUDO_TENSOR.....	95
*MAT_ORIENTED_CRACK.....	103
*MAT_POWER_LAW_PLASTICITY.....	106
*MAT_STRAIN_RATE_DEPENDENT_PLASTICITY.....	109
*MAT_RIGID.....	112
*MAT_ORTHOTROPIC_THERMAL.....	117
*MAT_COMPOSITE_DAMAGE.....	123
*MAT_TEMPERATURE_DEPENDENT_ORTHOTROPIC.....	127
*MAT_PIECEWISE_LINEAR_PLASTICITY.....	132
*MAT_GEOLOGIC_CAP_MODEL.....	138

# TABLE OF CONTENTS

---

*MAT_HONEYCOMB.....	144
*MAT_MOONEY-RIVLIN_RUBBER.....	152
*MAT_RESULTANT_PLASTICITY.....	155
*MAT_FORCE_LIMITED.....	156
*MAT_SHAPE_MEMORY.....	162
*MAT_FRAZER_NASH_RUBBER_MODEL.....	166
*MAT_LAMINATED_GLASS.....	169
*MAT_BARLAT_ANISOTROPIC_PLASTICITY.....	171
*MAT_BARLAT_YLD96.....	175
*MAT_FABRIC.....	179
*MAT_PLASTIC_GREEN-NAGHDI_RATE.....	188
*MAT_3-PARAMETER_BARLAT_{OPTION}.....	189
*MAT_TRANSVERSELY_ANISOTROPIC_ELASTIC_PLASTIC_{OPTION}.....	201
*MAT_BLATZ-KO_FOAM.....	208
*MAT_FLD_TRANSVERSELY_ANISOTROPIC.....	210
*MAT_NONLINEAR_ORTHOTROPIC.....	212
*MAT_USER_DEFINED_MATERIAL_MODELS.....	217
*MAT_BAMMAN.....	222
*MAT_BAMMAN_DAMAGE.....	227
*MAT_CLOSED_CELL_FOAM.....	230
*MAT_ENHANCED_COMPOSITE_DAMAGE.....	233
*MAT_LOW_DENSITY_FOAM.....	242
*MAT_LAMINATED_COMPOSITE_FABRIC.....	247
*MAT_COMPOSITE_FAILURE_{OPTION}_MODEL.....	253
*MAT_ELASTIC_WITH_VISCOSITY.....	258
*MAT_ELASTIC_WITH_VISCOSITY_CURVE.....	261
*MAT_KELVIN-MAXWELL_VISCOELASTIC.....	264
*MAT_VISCOUS_FOAM.....	266
*MAT_CRUSHABLE_FOAM.....	268
*MAT_RATE_SENSITIVE_POWERLAW_PLASTICITY.....	270
*MAT_MODIFIED_ZERILLI_ARMSTRONG.....	272
*MAT_LINEAR_ELASTIC_DISCRETE_BEAM.....	275
*MAT_NONLINEAR_ELASTIC_DISCRETE_BEAM.....	277
*MAT_NONLINEAR_PLASTIC_DISCRETE_BEAM.....	282
*MAT_SID_DAMPER_DISCRETE_BEAM.....	288
*MAT_HYDRAULIC_GAS_DAMPER_DISCRETE_BEAM.....	292
*MAT_CABLE_DISCRETE_BEAM.....	294

# TABLE OF CONTENTS

---

*MAT_CONCRETE_DAMAGE.....	297
*MAT_CONCRETE_DAMAGE_REL3.....	301
*MAT_LOW_DENSITY_VISCOUS_FOAM .....	309
*MAT_ELASTIC_SPRING_DISCRETE_BEAM.....	314
*MAT_BILKHU/DUBOIS_FOAM.....	316
*MAT_GENERAL_VISCOELASTIC.....	319
*MAT_HYPERELASTIC_RUBBER .....	323
*MAT_OGDEN_RUBBER.....	329
*MAT_SOIL_CONCRETE.....	334
*MAT_HYSTERETIC_SOIL.....	338
*MAT_RAMBERG-OSGOOD.....	345
*MAT_PLASTICITY_WITH_DAMAGE_{OPTION}.....	347
*MAT_FU_CHANG_FOAM_{OPTION}.....	355
*MAT_WINFRITH_CONCRETE.....	365
*MAT_WINFRITH_CONCRETE_REINFORCEMENT.....	369
*MAT_ORTHOTROPIC_VISCOELASTIC.....	371
*MAT_CELLULAR_RUBBER.....	374
*MAT_MTS.....	378
*MAT_PLASTICITY_POLYMER.....	383
*MAT_ACOUSTIC.....	386
*MAT_SOFT_TISSUE_{OPTION}.....	388
*MAT_ELASTIC_6DOF_SPRING_DISCRETE_BEAM.....	393
*MAT_INELASTIC_SPRING_DISCRETE_BEAM.....	394
*MAT_INELASTIC_6DOF_SPRING_DISCRETE_BEAM.....	397
*MAT_BRITTLE_DAMAGE.....	398
*MAT_GENERAL_JOINT_DISCRETE_BEAM.....	401
*MAT_SIMPLIFIED_JOHNSON_COOK.....	403
*MAT_SIMPLIFIED_JOHNSON_COOK_ORTHOTROPIC_DAMAGE.....	406
*MAT_SPOTWELD_{OPTION}.....	408
*MAT_SPOTWELD_DAIMLERCHRYSLER.....	420
*MAT_GEPLASTIC_SRATE_2000A.....	423
*MAT_INV_HYPERBOLIC_SIN.....	425
*MAT_ANISOTROPIC_VISCOPLASTIC.....	427
*MAT_ANISOTROPIC_PLASTIC.....	433
*MAT_DAMAGE_1.....	437
*MAT_DAMAGE_2.....	444
*MAT_ELASTIC_VISCOPLASTIC_THERMAL.....	448

# TABLE OF CONTENTS

---

*MAT_MODIFIED_JOHNSON_COOK.....	451
*MAT_ORTHO_ELASTIC_PLASTIC .....	459
*MAT_JOHNSON_HOLMQUIST_CERAMICS.....	464
*MAT_JOHNSON_HOLMQUIST_CONCRETE.....	467
*MAT_FINITE_ELASTIC_STRAIN_PLASTICITY .....	470
*MAT_TRIP.....	473
*MAT_LAYERED_LINEAR_PLASTICITY .....	477
*MAT_UNIFIED_CREEP .....	481
*MAT_COMPOSITE_LAYUP.....	482
*MAT_COMPOSITE_MATRIX.....	486
*MAT_COMPOSITE_DIRECT.....	489
*MAT_GENERAL_NONLINEAR_6DOF_DISCRETE_BEAM .....	491
*MAT_GURSON.....	498
*MAT_GURSON_JC.....	504
*MAT_GURSON_RCDC.....	511
*MAT_GENERAL_NONLINEAR_1DOF_DISCRETE_BEAM .....	517
*MAT_HILL_3R.....	520
*MAT_MODIFIED_PIECEWISE_LINEAR_PLASTICITY_{OPTION}.....	523
*MAT_PLASTICITY_COMPRESSION_TENSION.....	528
*MAT_KINEMATIC_HARDENING_TRANSVERSELY_ANISOTROPIC.....	532
*MAT_MODIFIED_HONEYCOMB.....	538
*MAT_ARRUDA_BOYCE_RUBBER.....	549
*MAT_HEART_TISSUE.....	552
*MAT_LUNG_TISSUE.....	557
*MAT_SPECIAL_ORTHOTROPIC.....	560
*MAT_ISOTROPIC_SMEARED_CRACK.....	564
*MAT_ORTHOTROPIC_SMEARED_CRACK.....	567
*MAT_BARLAT_YLD2000.....	572
*MAT_VISCOELASTIC_FABRIC.....	583
*MAT_WTM_STM.....	587
*MAT_WTM_STM_PLC.....	597
*MAT_CORUS_VEGTER.....	602
*MAT_COHESIVE_MIXED_MODE.....	606
*MAT_MODIFIED_FORCE_LIMITED .....	610
*MAT_VACUUM.....	621
*MAT_RATE_SENSITIVE_POLYMER.....	622
*MAT_TRANSVERSELY_ISOTROPIC_CRUSHABLE_FOAM.....	624

# TABLE OF CONTENTS

---

*MAT_WOOD_{OPTION} .....	628
*MAT_PITZER_CRUSHABLE_FOAM .....	635
*MAT_SCHWER_MURRAY_CAP_MODEL .....	637
*MAT_1DOF_GENERALIZED_SPRING .....	646
*MAT_FHWA_SOIL .....	648
*MAT_FHWA_SOIL_NEBRASKA .....	651
*MAT_GAS_MIXTURE .....	652
*MAT_EMMI .....	658
*MAT_DAMAGE_3 .....	665
*MAT_DESHPANDE_FLECK_FOAM .....	670
*MAT_PLASTICITY_COMPRESSION_TENSION_EOS .....	673
*MAT_MUSCLE .....	677
*MAT_ANISOTROPIC_ELASTIC_PLASTIC .....	680
*MAT_RATE_SENSITIVE_COMPOSITE_FABRIC .....	684
*MAT_CSCM_{OPTION} .....	690
*MAT_ALE_INCOMPRESSIBLE .....	701
*MAT_COMPOSITE_MSC_{OPTION} .....	703
*MAT_MODIFIED_CRUSHABLE_FOAM .....	715
*MAT_BRAIN_LINEAR_VISCOELASTIC .....	718
*MAT_PLASTIC_NONLINEAR_KINEMATIC .....	720
*MAT_MOMENT_CURVATURE_BEAM .....	722
*MAT_MCCORMICK .....	726
*MAT_POLYMER .....	729
*MAT_ARUP_ADHESIVE .....	734
*MAT_RESULTANT_ANISOTROPIC .....	740
*MAT_STEEL_CONCENTRIC_BRACE .....	744
*MAT_CONCRETE_EC2 .....	749
*MAT_MOHR_COULOMB .....	761
*MAT_RC_BEAM .....	766
*MAT_VISCOELASTIC_THERMAL .....	772
*MAT_QUASILINEAR_VISCOELASTIC .....	776
*MAT_HILL_FOAM .....	781
*MAT_VISCOELASTIC_HILL_FOAM .....	784
*MAT_LOW_DENSITY_SYNTHETIC_FOAM_{OPTION} .....	788
*MAT_SIMPLIFIED_RUBBER/FOAM_{OPTION} .....	793
*MAT_SIMPLIFIED_RUBBER_WITH_DAMAGE .....	798
*MAT_COHESIVE_ELASTIC .....	801

# TABLE OF CONTENTS

---

*MAT_COHESIVE_TH.....	802
*MAT_COHESIVE_GENERAL.....	805
*MAT_SAMP-1.....	809
*MAT_THERMO_ELASTO_VISCOPLASTIC_CREEP.....	815
*MAT_ANISOTROPIC_THERMOELASTIC.....	819
*MAT_FLD_3-PARAMETER_BARLAT.....	822
*MAT_SEISMIC_BEAM.....	827
*MAT_SOIL_BRICK.....	835
*MAT_DRUCKER_PRAGER.....	838
*MAT_RC_SHEAR_WALL.....	840
*MAT_CONCRETE_BEAM.....	847
*MAT_GENERAL_SPRING_DISCRETE_BEAM.....	850
*MAT_SEISMIC_ISOLATOR.....	853
*MAT_JOINTED_ROCK.....	858
*MAT_STEEL_EC3.....	862
*MAT_BOLT_BEAM.....	865
*MAT_CODAM2.....	868
*MAT_RIGID_DISCRETE.....	878
*MAT_ORTHOTROPIC_SIMPLIFIED_DAMAGE.....	879
*MAT_TABULATED_JOHNSON_COOK.....	887
*MAT_VISCOPLASTIC_MIXED_HARDENING.....	891
*MAT_KINEMATIC_HARDENING_BARLAT89.....	893
*MAT_PML_ELASTIC.....	899
*MAT_PML_ELASTIC_FLUID.....	901
*MAT_PML_ACOUSTIC.....	902
*MAT_BIOT_HYSTERETIC.....	904
*MAT_CAZACU_BARLAT.....	906
*MAT_VISCOELASTIC_LOOSE_FABRIC.....	917
*MAT_MICROMECHANICS_DRY_FABRIC.....	923
*MAT_SCC_ON_RCC.....	929
*MAT_PML_HYSTERETIC.....	933
*MAT_PERT_PIECEWISE_LINEAR_PLASTICITY.....	934
*MAT_COHESIVE_MIXED_MODE_ELASTOPLASTIC_RATE.....	935
*MAT_JOHNSON_HOLMQUIST_JH1.....	941
*MAT_KINEMATIC_HARDENING_BARLAT2000.....	946
*MAT_HILL_90.....	951
*MAT_UHS_STEEL.....	959



# TABLE OF CONTENTS

---

*MAT_PML_{OPTION}TROPIC_ELASTIC .....	970
*MAT_PML_NULL .....	973
* MAT_PIECEWISE_LINEAR_PLASTIC_THERMAL .....	975
*MAT_AMORPHOUS_SOLIDS_FINITE_STRAIN .....	978
*MAT_TISSUE_DISPERSED .....	981
*MAT_EIGHT_CHAIN_RUBBER .....	989
*MAT_RHT .....	998
*MAT_CHRONOLOGICAL_VISCOELASTIC .....	1007
*MAT_ALE_VISCOUS .....	1011
*MAT_ALE_GAS_MIXTURE .....	1014
*MAT_ALE_HERSCHEL .....	1020
*MAT_SPRING_ELASTIC .....	1023
*MAT_DAMPER_VISCOUS .....	1024
*MAT_SPRING_ELASTOPLASTIC .....	1025
*MAT_SPRING_NONLINEAR_ELASTIC .....	1026
*MAT_DAMPER_NONLINEAR_VISCOUS .....	1027
*MAT_SPRING_GENERAL_NONLINEAR .....	1028
*MAT_SPRING_MAXWELL .....	1030
*MAT_SPRING_INELASTIC .....	1032
*MAT_SPRING_TRILINEAR_DEGRADING .....	1033
*MAT_SPRING_SQUAT_SHEARWALL .....	1034
*MAT_SPRING_MUSCLE .....	1035
*MAT_SEATBELT .....	1040
*MAT_THERMAL_{OPTION} .....	1042
*MAT_THERMAL_ORTHOTROPIC .....	1044
*MAT_THERMAL_ISOTROPIC_TD .....	1046
*MAT_THERMAL_ORTHOTROPIC_TD .....	1048
*MAT_THERMAL_ISOTROPIC_PHASE_CHANGE .....	1051
*MAT_THERMAL_ISOTROPIC_TD_LC .....	1054
*MAT_THERMAL_USER_DEFINED .....	1055



# **\*MAT**

LS-DYNA has historically referenced each material model by a number. As shown below, a three digit numerical designation can still be used, e.g., \*MAT\_001, and is equivalent to a corresponding descriptive designation, e.g., \*MAT\_ELASTIC. The two equivalent commands for each material model, one numerical and the other descriptive, are listed below. The numbers in square brackets (see key below) identify the element formulations for which the material model is implemented. The number in the curly brackets, {*n*}, indicates the default number of history variables per element integration point that are stored in addition to the 7 history variables which are stored by default. For the type 16 fully integrated shell elements with 2 integration points through the thickness, the total number of history variables is 8 x (*n*+7). For the Belytschko-Tsay type 2 element the number is 2 x (*n*+7).

An additional option TITLE may be appended to a \*MAT keyword in which case an additional line is read in 80a format which can be used to describe the material. At present, LS-DYNA does not make use of the title. Inclusion of titles simply gives greater clarity to input decks.

## **Key to numbers in square brackets**

<b>0</b>	-	<b>Solids</b>
<b>1H</b>	-	<b>Hughes-Liu beam</b>
<b>1B</b>	-	<b>Belytschko resultant beam</b>
<b>1I</b>	-	<b>Belytschko integrated solid and tubular beams</b>
<b>1T</b>	-	<b>Truss</b>
<b>1D</b>	-	<b>Discrete beam</b>
<b>1SW</b>	-	<b>Spotweld beam</b>
<b>2</b>	-	<b>Shells</b>
<b>3a</b>	-	<b>Thick shell formulation 1</b>
<b>3b</b>	-	<b>Thick shell formulation 2</b>
<b>3c</b>	-	<b>Thick shell formulation 3</b>
<b>3d</b>	-	<b>Thick shell formulation 5</b>
<b>4</b>	-	<b>Special airbag element</b>
<b>5</b>	-	<b>SPH element</b>
<b>6</b>	-	<b>Acoustic solid</b>
<b>7</b>	-	<b>Cohesive solid</b>
<b>8A</b>	-	<b>Multi-material ALE solid (validated)</b>
<b>8B</b>	-	<b>Multi-material ALE solid (implemented but not validated<sup>1</sup>)</b>
<b>9</b>	-	<b>Membrane element</b>

\*MAT\_ADD\_EROSION<sup>2</sup>

\*MAT\_ADD\_PERMEABILITY

\*MAT\_ADD\_PORE\_AIR

---

<sup>1</sup> Error associated with advection inherently leads to state variables that may be inconsistent with nonlinear constitutive routines and thus may lead to nonphysical results, nonconservation of energy, and even numerical instability in some cases. Caution is advised, particularly when using the 2<sup>nd</sup> tier of material models implemented for ALE multi-material solids (designated by [8B]) which are largely untested as ALE materials.

<sup>2</sup> These three commands do not, by themselves, define a material model but rather can be used in certain cases to supplement material models

# \*MAT

---

\*MAT\_ADD\_THERMAL\_EXPANSION<sup>2</sup>

\*MAT\_NONLOCAL<sup>2</sup>

\*MAT\_001: \*MAT\_ELASTIC [0,1H,1B,1I,1T,2,3abcd,5,8A] {0}  
\*MAT\_001\_FLUID: \*MAT\_ELASTIC\_FLUID [0,8A] {0}  
\*MAT\_002: \*MAT\_{OPTION}TROPIC\_ELASTIC [0,2,3abc] {15}  
\*MAT\_003: \*MAT\_PLASTIC\_KINEMATIC [0,1H,1I,1T,2,3abcd,5,8A] {5}  
\*MAT\_004: \*MAT\_ELASTIC\_PLASTIC\_THERMAL [0,1H,1T,2,3abcd,8B] {3}  
\*MAT\_005: \*MAT\_SOIL\_AND\_FOAM [0,5,3cd,8A] {0}  
\*MAT\_006: \*MAT\_VISCOELASTIC [0,1H,2,3abcd,5,8B] {19}  
\*MAT\_007: \*MAT\_BLATZ-KO\_RUBBER [0,2,3abc,8B] {9}  
\*MAT\_008: \*MAT\_HIGH\_EXPLOSIVE\_BURN [0,5,3cd,8A] {4}  
\*MAT\_009: \*MAT\_NULL [0,1,2,3cd,5,8A] {3}  
\*MAT\_010: \*MAT\_ELASTIC\_PLASTIC\_HYDRO\_{OPTION} [0,3cd,5,8B] {4}  
\*MAT\_011: \*MAT\_STEINBERG [0,3cd,5,8B] {5}  
\*MAT\_011\_LUND: \*MAT\_STEINBERG\_LUND [0,3cd,5,8B] {5}  
\*MAT\_012: \*MAT\_ISOTROPIC\_ELASTIC\_PLASTIC [0,2,3abcd,5,8B] {0}  
\*MAT\_013: \*MAT\_ISOTROPIC\_ELASTIC\_FAILURE [0,3cd,5,8B] {1}  
\*MAT\_014: \*MAT\_SOIL\_AND\_FOAM\_FAILURE [0,3cd,5,8B] {1}  
\*MAT\_015: \*MAT\_JOHNSON\_COOK [0,2,3abcd,5,8A] {6}  
\*MAT\_016: \*MAT\_PSEUDO\_TENSOR [0,3cd,5,8B] {6}  
\*MAT\_017: \*MAT\_ORIENTED\_CRACK [0,3cd] {10}  
\*MAT\_018: \*MAT\_POWER\_LAW\_PLASTICITY [0,1H,2,3abcd,5,8B] {0}  
\*MAT\_019: \*MAT\_STRAIN\_RATE\_DEPENDENT\_PLASTICITY [0,2,3abcd,5,8B] {6}  
\*MAT\_020: \*MAT\_RIGID [0,1H,1B,1T,2,3ab] {0}  
\*MAT\_021: \*MAT\_ORTHOTROPIC\_THERMAL [0,2,3abc] {29}  
\*MAT\_022: \*MAT\_COMPOSITE\_DAMAGE [0,2,3abcd,5] {12}  
\*MAT\_023: \*MAT\_TEMPERATURE\_DEPENDENT\_ORTHOTROPIC [0,2,3abc] {19}  
\*MAT\_024: \*MAT\_PIECEWISE\_LINEAR\_PLASTICITY [0,1H,2,3abcd,5,8A] {5}  
\*MAT\_025: \*MAT\_GEOLOGIC\_CAP\_MODEL [0,3cd,5] {12}  
\*MAT\_026: \*MAT\_HONEYCOMB [0,3cd] {20}  
\*MAT\_027: \*MAT\_MOONEY-RIVLIN\_RUBBER [0,1T,2,3c,8B] {9}  
\*MAT\_028: \*MAT\_RESULTANT\_PLASTICITY [1B,2] {5}  
\*MAT\_029: \*MAT\_FORCE\_LIMITED [1B] {30}  
\*MAT\_030: \*MAT\_SHAPE\_MEMORY [0,2,3abc,5] {23}  
\*MAT\_031: \*MAT\_FRAZER\_NASH\_RUBBER\_MODEL [0,3c,8B] {9}  
\*MAT\_032: \*MAT\_LAMINATED\_GLASS [2,3ab] {0}  
\*MAT\_033: \*MAT\_BARLAT\_ANISOTROPIC\_PLASTICITY [0,2,3abcd] {9}  
\*MAT\_033\_96: \*MAT\_BARLAT\_YLD96 [2,3ab] {9}  
\*MAT\_034: \*MAT\_FABRIC [4] {17}  
\*MAT\_035: \*MAT\_PLASTIC\_GREEN-NAGHDI\_RATE [0,3cd,5,8B] {22}  
\*MAT\_036: \*MAT\_3-PARAMETER\_BARLAT [2,3ab,5] {7}  
\*MAT\_037: \*MAT\_TRANSVERSELY\_ANISOTROPIC\_ELASTIC\_PLASTIC [2,3ab] {9}  
\*MAT\_038: \*MAT\_BLATZ-KO\_FOAM [0,2,3c,8B] {9}  
\*MAT\_039: \*MAT\_FLD\_TRANSVERSELY\_ANISOTROPIC [2,3ab] {6}  
\*MAT\_040: \*MAT\_NONLINEAR\_ORTHOTROPIC [0,2,3c] {17}  
\*MAT\_041-050: \*MAT\_USER\_DEFINED\_MATERIAL\_MODELS [0,1H,1T,1D,2,3abcd,5,8B] {0}  
\*MAT\_051: \*MAT\_BAMMAN [0,2,3abcd,5,8B] {8}  
\*MAT\_052: \*MAT\_BAMMAN\_DAMAGE [0,2,3abcd,5,8B] {10}  
\*MAT\_053: \*MAT\_CLOSED\_CELL\_FOAM [0,3cd,8B] {0}  
\*MAT\_054-055: \*MAT\_ENHANCED\_COMPOSITE\_DAMAGE [0,2,3cd] {20}  
\*MAT\_057: \*MAT\_LOW\_DENSITY\_FOAM [0,3cd,5,8B] {26}  
\*MAT\_058: \*MAT\_LAMINATED\_COMPOSITE\_FABRIC [2,3ab] {15}  
\*MAT\_059: \*MAT\_COMPOSITE\_FAILURE\_{OPTION}\_MODEL [0,2,3cd,5] {22}  
\*MAT\_060: \*MAT\_ELASTIC\_WITH\_VISCOSITY [0,2,3abcd,5,8B] {8}

*MAT_060C:	*MAT_ELASTIC_WITH_VISCOSITY_CURVE [0,2,3abcd,5,8B] {8}
*MAT_061:	*MAT_KELVIN-MAXWELL_VISCOELASTIC [0,3cd,5,8B] {14}
*MAT_062:	*MAT_VISCOUS_FOAM [0,3cd,8B] {7}
*MAT_063:	*MAT_CRUSHABLE_FOAM [0,3cd,5,8B] {8}
*MAT_064:	*MAT_RATE_SENSITIVE_POWERLAW_PLASTICITY [0,2,3abcd,5,8B] {30}
*MAT_065:	*MAT_MODIFIED_ZERILLI_ARMSTRONG [0,2,3abcd,5,8B] {6}
*MAT_066:	*MAT_LINEAR_ELASTIC_DISCRETE_BEAM [1D] {8}
*MAT_067:	*MAT_NONLINEAR_ELASTIC_DISCRETE_BEAM [1D] {14}
*MAT_068:	*MAT_NONLINEAR_PLASTIC_DISCRETE_BEAM [1D] {25}
*MAT_069:	*MAT_SID_DAMPER_DISCRETE_BEAM [1D] {13}
*MAT_070:	*MAT_HYDRAULIC_GAS_DAMPER_DISCRETE_BEAM [1D] {8}
*MAT_071:	*MAT_CABLE_DISCRETE_BEAM [1D] {8}
*MAT_072:	*MAT_CONCRETE_DAMAGE [0,3cd,5,8B] {6}
*MAT_072R3:	*MAT_CONCRETE_DAMAGE_REL3 [0,3cd,5] {6}
*MAT_073:	*MAT_LOW_DENSITY_VISCOUS_FOAM [0,3cd,8B] {56}
*MAT_074:	*MAT_ELASTIC_SPRING_DISCRETE_BEAM [1D] {8}
*MAT_075:	*MAT_BILKHU/DUBOIS_FOAM [0,3cd,5,8B] {8}
*MAT_076:	*MAT_GENERAL_VISCOELASTIC [0,2,3abcd,5,8B] {53}
*MAT_077_H:	*MAT_HYPERELASTIC_RUBBER [0,2,3cd,5,8B] {54}
*MAT_077_O:	*MAT_OGDEN_RUBBER [0,2,3cd,8B] {54}
*MAT_078:	*MAT_SOIL_CONCRETE [0,3cd,5,8B] {3}
*MAT_079:	*MAT_HYSTERETIC_SOIL [0,3cd,5,8B] {77}
*MAT_080:	*MAT_RAMBERG-OSGOOD [0,3cd,8B] {18}
*MAT_081:	*MAT_PLASTICITY_WITH_DAMAGE [0,2,3abcd] {5}
*MAT_082( RCDC):	*MAT_PLASTICITY_WITH_DAMAGE_ORTHO( RCDC) [0,2,3abcd] {22}
*MAT_083:	*MAT_FU_CHANG_FOAM [0,3cd,5,8B] {54}
*MAT_084-085:	*MAT_WINFRITH_CONCRETE [0,8B] {54}
*MAT_086:	*MAT_ORTHOTROPIC_VISCOELASTIC [2,3ab] {17}
*MAT_087:	*MAT_CELLULAR_RUBBER [0,3cd,5,8B] {19}
*MAT_088:	*MAT_MTS [0,2,3abcd,5,8B] {5}
*MAT_089:	*MAT_PLASTICITY_POLYMER [0,2,3abcd] {45}
*MAT_090:	*MAT_ACOUSTIC [6] {25}
*MAT_091:	*MAT_SOFT_TISSUE [0,2] {16}
*MAT_092:	*MAT_SOFT_TISSUE_VISCO [0,2] {58}
*MAT_093:	*MAT_ELASTIC_6DOF_SPRING_DISCRETE_BEAM [1D] {25}
*MAT_094:	*MAT_INELASTIC_SPRING_DISCRETE_BEAM [1D] {9}
*MAT_095:	*MAT_INELASTIC_6DOF_SPRING_DISCRETE_BEAM [1D] {25}
*MAT_096:	*MAT_BRITTLE_DAMAGE [0,8B] {51}
*MAT_097:	*MAT_GENERAL_JOINT_DISCRETE_BEAM [1D] {23}
*MAT_098:	*MAT_SIMPLIFIED_JOHNSON_COOK [0,1H,1B,1T,2,3abcd] {6}
*MAT_099:	*MAT_SIMPLIFIED_JOHNSON_COOK_ORTHOTROPIC_DAMAGE [0,2,3abcd] {22}
*MAT_100:	*MAT_SPOTWELD_{OPTION} [0,1SW] {6}
*MAT_100_DA:	*MAT_SPOTWELD_DAIMLERCHRYSLER [0] {6}
*MAT_101:	*MAT_GEPLASTIC_SRATE_2000a [2,3ab] {15}
*MAT_102:	*MAT_INV_HYPERBOLIC_SIN [0,3cd,8B] {15}
*MAT_103:	*MAT_ANISOTROPIC_VISCOPLASTIC [0,2,3abcd,5] {20}
*MAT_103_P:	*MAT_ANISOTROPIC_PLASTIC [2,3abcd] {20}
*MAT_104:	*MAT_DAMAGE_1 [0,2,3abcd] {11}
*MAT_105:	*MAT_DAMAGE_2 [0,2,3abcd] {7}
*MAT_106:	*MAT_ELASTIC_VISCOPLASTIC_THERMAL [0,2,3abcd] {20}
*MAT_107:	*MAT_MODIFIED_JOHNSON_COOK [0,2,3abcd,5,8B] {15}
*MAT_108:	*MAT_ORTHO_ELASTIC_PLASTIC [2,3ab] {15}
*MAT_110:	*MAT_JOHNSON_HOLMQUIST_CERAMICS [0,3cd,5] {15}
*MAT_111:	*MAT_JOHNSON_HOLMQUIST_CONCRETE [0,3cd,5] {25}
*MAT_112:	*MAT_FINITE_ELASTIC_STRAIN_PLASTICITY [0,3c,5] {22}

# \*MAT

---

\*MAT\_113: \*MAT\_TRIP [2,3ab] {5}  
\*MAT\_114: \*MAT\_LAYERED\_LINEAR\_PLASTICITY [2,3ab] {13}  
\*MAT\_115: \*MAT\_UNIFIED\_CREEP [0,2,3abcd,5] {1}  
\*MAT\_116: \*MAT\_COMPOSITE\_LAYUP [2] {30}  
\*MAT\_117: \*MAT\_COMPOSITE\_MATRIX [2] {30}  
\*MAT\_118: \*MAT\_COMPOSITE\_DIRECT [2] {10}  
\*MAT\_119: \*MAT\_GENERAL\_NONLINEAR\_6DOF\_DISCRETE\_BEAM [1D] {62}  
\*MAT\_120: \*MAT\_GURSON [0,2,3abcd] {12}  
\*MAT\_120\_JC: \*MAT\_GURSON\_JC [0,2] {12}  
\*MAT\_120\_RCDC: \*MAT\_GURSON\_RCDC [0,2] {12}  
\*MAT\_121: \*MAT\_GENERAL\_NONLINEAR\_1DOF\_DISCRETE\_BEAM [1D] {20}  
\*MAT\_122: \*MAT\_HILL\_3R [2,3ab] {8}  
\*MAT\_123: \*MAT\_MODIFIED\_PIECEWISE\_LINEAR\_PLASTICITY [0,2,3abcd,5] {11}  
\*MAT\_124: \*MAT\_PLASTICITY\_COMPRESSION\_TENSION [0,1H,2,3abcd,5,8B] {7}  
\*MAT\_125: \*MAT\_KINEMATIC\_HARDENING\_TRANSVERSELY\_ANISOTROPIC [0,2,3abcd] {11}  
\*MAT\_126: \*MAT\_MODIFIED\_HONEYCOMB [0,3cd] {20}  
\*MAT\_127: \*MAT\_ARRUDA\_BOYCE\_RUBBER [0,3cd,5] {49}  
\*MAT\_128: \*MAT\_HEART\_TISSUE [0,3c] {15}  
\*MAT\_129: \*MAT\_LUNG\_TISSUE [0,3cd] {49}  
\*MAT\_130: \*MAT\_SPECIAL\_ORTHOTROPIC [2] {35}  
\*MAT\_131: \*MAT\_ISOTROPIC\_SMEARED\_CRACK [0,5,8B] {15}  
\*MAT\_132: \*MAT\_ORTHOTROPIC\_SMEARED\_CRACK [0] {61}  
\*MAT\_133: \*MAT\_BARLAT\_YLD2000 [2,3ab] {9}  
\*MAT\_134: \*MAT\_VISCOELASTIC\_FABRIC [9]  
\*MAT\_135: \*MAT\_WTM\_STM [2,3ab] {30}  
\*MAT\_135\_PLC: \*MAT\_WTM\_STM\_PLC [2,3ab] {30}  
\*MAT\_136: \*MAT\_CORUS\_VEGTER [2,3ab] {5}  
\*MAT\_138: \*MAT\_COHESIVE\_MIXED\_MODE [7] {0}  
\*MAT\_139: \*MAT\_MODIFIED\_FORCE\_LIMITED [1B] {35}  
\*MAT\_140: \*MAT\_VACUUM [0,8A] {0}  
\*MAT\_141: \*MAT\_RATE\_SENSITIVE\_POLYMER [0,3cd,8B] {6}  
\*MAT\_142: \*MAT\_TRANSVERSELY\_ANISOTROPIC\_CRUSHABLE\_FOAM [0,3cd] {12}  
\*MAT\_143: \*MAT\_WOOD {OPTION} [0,3cd,5] {37}  
\*MAT\_144: \*MAT\_PITZER\_CRUSHABLEFOAM [0,3cd,8B] {7}  
\*MAT\_145: \*MAT\_SCHWER\_MURRAY\_CAP\_MODEL [0,5] {50}  
\*MAT\_146: \*MAT\_1DOF\_GENERALIZED\_SPRING [1D] {1}  
\*MAT\_147: \*MAT\_FHWA\_SOIL [0,3cd,5,8B] {15}  
\*MAT\_147\_N: \*MAT\_FHWA\_SOIL\_NEBRASKA [0,3cd,5,8B] {15}  
\*MAT\_148: \*MAT\_GAS\_MIXTURE [0,8A] {14}  
\*MAT\_151: \*MAT\_EMMI [0,3cd,5,8B] {23}  
\*MAT\_153: \*MAT\_DAMAGE\_3 [0,1H,2,3abcd]  
\*MAT\_154: \*MAT\_DESHPANDE\_FLECK\_FOAM [0,3cd,8B] {10}  
\*MAT\_155: \*MAT\_PLASTICITY\_COMPRESSION\_TENSION\_EOS [0,3cd,5,8B] {16}  
\*MAT\_156: \*MAT\_MUSCLE [1T] {0}  
\*MAT\_157: \*MAT\_ANISOTROPIC\_ELASTIC\_PLASTIC [2,3ab] {5}  
\*MAT\_158: \*MAT\_RATE\_SENSITIVE\_COMPOSITE\_FABRIC [2,3ab] {54}  
\*MAT\_159: \*MAT\_CSCM {OPTION} [0,3cd,5] {22}  
\*MAT\_160: \*MAT\_ALE\_INCOMPRESSIBLE  
\*MAT\_161: \*MAT\_COMPOSITE\_MSC [0] {34}  
\*MAT\_162: \*MAT\_COMPOSITE\_DMG\_MSC [0] {40}  
\*MAT\_163: \*MAT\_MODIFIED\_CRUSHABLE\_FOAM [0,3cd,8B] {10}  
\*MAT\_164: \*MAT\_BRAIN\_LINEAR\_VISCOELASTIC [0] {14}  
\*MAT\_165: \*MAT\_PLASTIC\_NONLINEAR\_KINEMATIC [0,2,3abcd,8B] {8}  
\*MAT\_166: \*MAT\_MOMENT\_CURVATURE\_BEAM [1B] {54}  
\*MAT\_167: \*MAT\_MCCORMICK [03cd,,8B] {8}

\*MAT\_168: \*MAT\_POLYMER [0,3c,8B] {60}  
\*MAT\_169: \*MAT\_ARUP\_ADHESIVE [0] {20}  
\*MAT\_170: \*MAT\_RESULTANT\_ANISOTROPIC [2,3ab] {67}  
\*MAT\_171: \*MAT\_STEEL\_CONCENTRIC\_BRACE [1B] {33}  
\*MAT\_172: \*MAT\_CONCRETE\_EC2 [1H,2,3ab] {35}  
\*MAT\_173: \*MAT\_MOHR\_COULOMB [0,5] {31}  
\*MAT\_174: \*MAT\_RC\_BEAM [1H] {26}  
\*MAT\_175: \*MAT\_VISCOELASTIC\_THERMAL [0,2,3abcd,5,8B] {86}  
\*MAT\_176: \*MAT\_QUASILINEAR\_VISCOELASTIC [0,2,3abcd,5,8B] {81}  
\*MAT\_177: \*MAT\_HILL\_FOAM [0,3cd] {12}  
\*MAT\_178: \*MAT\_VISCOELASTIC\_HILL\_FOAM [0,3cd] {92}  
\*MAT\_179: \*MAT\_LOW\_DENSITY\_SYNTHETIC\_FOAM\_{OPTION} [0,3cd] {77}  
\*MAT\_181: \*MAT\_SIMPLIFIED\_RUBBER/FOAM\_{OPTION} [0,2,3cd] {39}  
\*MAT\_183: \*MAT\_SIMPLIFIED\_RUBBER\_WITH\_DAMAGE [0,2,3cd] {44}  
\*MAT\_184: \*MAT\_COHESIVE\_ELASTIC [7] {0}  
\*MAT\_185: \*MAT\_COHESIVE\_TH [7] {0}  
\*MAT\_186: \*MAT\_COHESIVE\_GENERAL [7] {6}  
\*MAT\_187: \*MAT\_SAMP-1 [0,2,3abcd] {38}  
\*MAT\_188: \*MAT\_THERMO\_ELASTO\_VISCOPLASTIC\_CREEP [0,2,3abcd] {27}  
\*MAT\_189: \*MAT\_ANISOTROPIC\_THERMOELASTIC [0,3c,8B] {21}  
\*MAT\_190: \*MAT\_FLD\_3-PARAMETER\_BARLAT [2,3ab] {36}  
\*MAT\_191: \*MAT\_SEISMIC\_BEAM [1B] {36}  
\*MAT\_192: \*MAT\_SOIL\_BRICK [0,3cd] {71}  
\*MAT\_193: \*MAT\_DRUCKER\_PRAGER [0,3cd] {74}  
\*MAT\_194: \*MAT\_RC\_SHEAR\_WALL [2,3ab] {36}  
\*MAT\_195: \*MAT\_CONCRETE\_BEAM [1H] {5}  
\*MAT\_196: \*MAT\_GENERAL\_SPRING\_DISCRETE\_BEAM [1D] {25}  
\*MAT\_197: \*MAT\_SEISMIC\_ISOLATOR [1D] {10}  
\*MAT\_198: \*MAT\_JOINTED\_ROCK [0] {31}  
\*MAT\_202: \*MAT\_STEEL\_EC3 [1H]  
\*MAT\_219: \*MAT\_CODAM2 [0,2,3abcd]  
\*MAT\_220: \*MAT\_RIGID\_DISCRETE [0,2]  
\*MAT\_221: \*MAT\_ORTHOTROPIC\_SIMPLIFIED\_DAMAGE [0,3cd,5] {17}  
\*MAT\_224: \*MAT\_TABULATED\_JOHNSON\_COOK [0,2,3abcd,,5] {11}  
\*MAT\_225: \*MAT\_VISCOPLASTIC\_MIXED\_HARDENING [0,2,3abcd,5]  
\*MAT\_226: \*MAT\_KINEMATIC\_HARDENING\_BARLAT89 [2,3ab]  
\*MAT\_230: \*MAT\_PML\_ELASTIC [0] {24}  
\*MAT\_231: \*MAT\_PML\_ACOUSTIC [6] {35}  
\*MAT\_232: \*MAT\_BIOT\_HYSTERETIC [0,2,3ab] {30}  
\*MAT\_233: \*MAT\_CAZACU\_BARLAT [2,3ab]  
\*MAT\_234: \*MAT\_VISCOELASTIC\_LOOSE\_FABRIC [2,3a]  
\*MAT\_235: \*MAT\_MICROMECHANICS\_DRY\_FABRIC [2,3a]  
\*MAT\_236: \*MAT\_SCC\_ON\_RCC [2,3ab]  
\*MAT\_237: \*MAT\_PML\_HYSTERETIC [0] {54}  
\*MAT\_238: \*MAT\_PERT\_PIECEWISE\_LINEAR\_PLASTICITY [0,1H,2,3,5,8A]  
\*MAT\_240: \*MAT\_COHESIVE\_MIXED\_MODE\_ELASTOPLASTIC\_RATE [0]  
\*MAT\_241: \*MAT\_JOHNSON\_HOLMQUIST\_JH1 [0,3cd,5]  
\*MAT\_242: \*MAT\_KINEMATIC\_HARDENING\_BARLAT2000 [2,3ab]  
\*MAT\_243: \*MAT\_HILL\_90 [2,3ab]  
\*MAT\_244: \*MAT\_UHS\_STEEL [0,2,3abcd,5]  
\*MAT\_245: \*MAT\_PML\_{OPTION}TROPIC\_ELASTIC [0] {30}  
\*MAT\_246: \*MAT\_PML\_NULL [0] {27}  
\*MAT\_255: \*MAT\_PIECEWISE\_LINEAR\_PLASTIC\_THERMAL [0,2,3abcd]  
\*MAT\_256: \*MAT\_AMORPHOUS\_SOLIDS\_FINITE\_STRAIN [0]  
\*MAT\_266: \*MAT\_TISSUE\_DISPERSED [0]

## \*MAT

---

\*MAT\_267:            \*MAT\_EIGHT\_CHAIN\_RUBBER [0,5]  
\*MAT\_272:            \*MAT\_RHT [0,5]  
\*MAT\_276:            \*MAT\_CHRONOLOGICAL\_VISCOELASTIC [2,3abcd]

For the discrete (type 6) beam elements, which are used to model complicated dampers and multi-dimensional spring-damper combinations, the following material types are available:

\*MAT\_066:            \*MAT\_LINEAR\_ELASTIC\_DISCRETE\_BEAM [1D]  
\*MAT\_067:            \*MAT\_NONLINEAR\_ELASTIC\_DISCRETE\_BEAM [1D]  
\*MAT\_068:            \*MAT\_NONLINEAR\_PLASTIC\_DISCRETE\_BEAM [1D]  
\*MAT\_069:            \*MAT\_SID\_DAMPER\_DISCRETE\_BEAM [1D]  
\*MAT\_070:            \*MAT\_HYDRAULIC\_GAS\_DAMPER\_DISCRETE\_BEAM [1D]  
\*MAT\_071:            \*MAT\_CABLE\_DISCRETE\_BEAM [1D]  
\*MAT\_074:            \*MAT\_ELASTIC\_SPRING\_DISCRETE\_BEAM [1D]  
\*MAT\_093:            \*MAT\_ELASTIC\_6DOF\_SPRING\_DISCRETE\_BEAM [1D]  
\*MAT\_094:            \*MAT\_INELASTIC\_SPRING\_DISCRETE\_BEAM [1D]  
\*MAT\_095:            \*MAT\_INELASTIC\_6DOF\_SPRING\_DISCRETE\_BEAM [1D]  
\*MAT\_119:            \*MAT\_GENERAL\_NONLINEAR\_6DOF\_DISCRETE\_BEAM [1D]  
\*MAT\_121:            \*MAT\_GENERAL\_NONLINEAR\_1DOF\_DISCRETE\_BEAM [1D]  
\*MAT\_146:            \*MAT\_1DOF\_GENERALIZED\_SPRING [1D]  
\*MAT\_196:            \*MAT\_GENERAL\_SPRING\_DISCRETE\_BEAM [1D]  
\*MAT\_197:            \*MAT\_SEISMIC\_ISOLATOR [1D]  
\*MAT\_208:            \*MAT\_BOLT\_BEAM [1D]

For the discrete springs and dampers the following material types are available

\*MAT\_S01:            \*MAT\_SPRING\_ELASTIC  
\*MAT\_S02:            \*MAT\_DAMPER\_VISCOUS  
\*MAT\_S03:            \*MAT\_SPRING\_ELASTOPLASTIC  
\*MAT\_S04:            \*MAT\_SPRING\_NONLINEAR\_ELASTIC  
\*MAT\_S05:            \*MAT\_DAMPER\_NONLINEAR\_VISCOUS  
\*MAT\_S06:            \*MAT\_SPRING\_GENERAL\_NONLINEAR  
\*MAT\_S07:            \*MAT\_SPRING\_MAXWELL  
\*MAT\_S08:            \*MAT\_SPRING\_INELASTIC  
\*MAT\_S13:            \*MAT\_SPRING\_TRILINEAR\_DEGRADING  
\*MAT\_S14:            \*MAT\_SPRING\_SQUAT\_SHEARWALL  
\*MAT\_S15:            \*MAT\_SPRING\_MUSCLE

For ALE solids the following material types are available:

\*MAT\_ALE\_01:        \*MAT\_ALE\_VACUUM            (same as \*MAT\_140)  
\*MAT\_ALE\_02:        \*MAT\_ALE\_VISCOUS        (similar to \*MAT\_009)  
\*MAT\_ALE\_03:        \*MAT\_ALE\_GAS\_MIXTURE    (same as \*MAT\_148)  
\*MAT\_ALE\_04:        \*MAT\_ALE\_HERSCHEL

For the seatbelts one material is available.

\*MAT\_B01:            \*MAT\_SEATBELT

For thermal materials in a coupled structural/thermal or thermal only analysis, six materials are available. These materials are related to the structural material via the \*PART card. Thermal materials are defined only for solid and shell elements.

\*MAT\_T01:            \*MAT\_THERMAL\_ISOTROPIC



*MAT_T02:	*MAT_THERMAL_ORTHOTROPIC
*MAT_T03:	*MAT_THERMAL_ISOTROPIC_TD
*MAT_T04:	*MAT_THERMAL_ORTHOTROPIC_TD
*MAT_T05:	*MAT_THERMAL_ISOTROPIC_PHASE_CHANGE
*MAT_T06:	*MAT_THERMAL_ISOTROPIC_TD_LC
*MAT_T11-T15:	*MAT_THERMAL_USER_DEFINED

DRAFT

**MATERIAL MODEL REFERENCE TABLES**

The tables provided on the following pages list the material models, some of their attributes, and the general classes of physical materials to which the numerical models might be applied.

If a material model includes any of the following attributes, a “Y” will appear in the respective column of the table:

<b>SRATE</b>	- Strain-rate effects
<b>FAIL</b>	- Failure criteria
<b>EOS</b>	- Equation-of-State required for 3D solids and 2D continuum elements
<b>THERM</b>	- Thermal effects
<b>ANISO</b>	- Anisotropic/orthotropic
<b>DAM</b>	- Damage effects
<b>TENS</b>	- Tension handled differently than compression in some manner

Potential applications of the material models, in terms of classes of physical materials, are abbreviated in the table as follows:

<b>GN</b>	- General
<b>CM</b>	- Composite
<b>CR</b>	- Ceramic
<b>FL</b>	- Fluid
<b>FM</b>	- Foam
<b>GL</b>	- Glass
<b>HY</b>	- Hydrodynamic material
<b>MT</b>	- Metal
<b>PL</b>	- Plastic
<b>RB</b>	- Rubber
<b>SL</b>	- Soil, concrete, or rock
<b>AD</b>	- Adhesive or Cohesive material
<b>BIO</b>	- Biological material
<b>CIV</b>	- Civil Engineering component

Material Number and Description	SRATE	FAIL	EOS	THERMAL	ANISO	DAM	TENS	Applications
1 Elastic								GN, FL
2 Orthotropic Elastic (Anisotropic-solids)					Y			CM, MT
3 Plastic Kinematic/Isotropic	Y	Y						CM, MT, PL
4 Elastic Plastic Thermal				Y				MT, PL
5 Soil and Foam							Y	FM, SL
6 Linear Viscoelastic	Y							RB
7 Blatz-Ko Rubber								RB
8 High Explosive Burn			Y					HY
9 Null Material	Y	Y	Y				Y	FL, HY
10 Elastic Plastic Hydro(dynamic)		Y	Y				Y	HY, MT
11 Steinberg: Temp. Dependent Elastoplastic	Y	Y	Y	Y			Y	HY, MT
12 Isotropic Elastic Plastic								MT
13 Isotropic Elastic with Failure		Y					Y	MT
14 Soil and Foam with Failure		Y					Y	FM, SL
15 Johnson/Cook Plasticity Model	Y	Y	Y	Y		Y	Y	HY, MT
16 Pseudo Tensor Geological Model	Y	Y	Y			Y	Y	SL
17 Oriented Crack (Elastoplastic w/ Fracture)		Y	Y		Y		Y	HY, MT, PL, CR
18 Power Law Plasticity (Isotropic)	Y							MT, PL
19 Strain Rate Dependent Plasticity	Y	Y						MT, PL
20 Rigid								
21 Orthotropic Thermal (Elastic)				Y	Y			GN
22 Composite Damage		Y			Y		Y	CM
23 Temperature Dependent Orthotropic				Y	Y			CM
24 Piecewise Linear Plasticity (Isotropic)	Y	Y						MT, PL
25 Inviscid Two Invariant Geologic Cap		Y					Y	SL
26 Honeycomb	Y	Y			Y		Y	CM, FM, SL
27 Mooney-Rivlin Rubber							Y	RB
28 Resultant Plasticity								MT
29 Force Limited Resultant Formulation							Y	
30 Shape Memory								MT
31 Frazer-Nash Rubber							Y	RB
32 Laminated Glass (Composite)		Y						CM, GL
33 Barlat Anisotropic Plasticity (YLD96)	Y				Y			CR, MT
34 Fabric					Y		Y	fabric
35 Plastic-Green Naghdi Rate	Y							MT
36 Three-Parameter Barlat Plasticity	Y			Y	Y			MT

Material Number and Description	SRATE	FAIL	EOS	THERMAL	ANISO	DAM	TENS	Applications
37 Transversely Anisotropic Elastic Plastic					Y			MT
38 Blatz-Ko Foam								FM, PL
39 FLD Transversely Anisotropic					Y			MT
40 Nonlinear Orthotropic		Y		Y	Y		Y	CM
41-50 User Defined Materials	Y	Y	Y	Y	Y	Y	Y	GN
51 Bamman (Temp/Rate Dependent Plasticity)	Y			Y				GN
52 Bamman Damage	Y	Y		Y		Y		MT
53 Closed cell foam (Low density polyurethane)								FM
54 Composite Damage with Chang Failure		Y			Y	Y	Y	CM
55 Composite Damage with Tsai-Wu Failure		Y			Y	Y	Y	CM
57 Low Density Urethane Foam	Y	Y					Y	FM
58 Laminated Composite Fabric		Y			Y	Y	Y	CM, fabric
59 Composite Failure (Plasticity Based)		Y			Y		Y	CM, CR
60 Elastic with Viscosity (Viscous Glass)	Y			Y				GL
61 Kelvin-Maxwell Viscoelastic	Y							FM
62 Viscous Foam (Crash dummy Foam)	Y							FM
63 Isotropic Crushable Foam							Y	FM
64 Rate Sensitive Powerlaw Plasticity	Y							MT
65 Zerilli-Armstrong (Rate/Temp Plasticity)	Y		Y	Y			Y	MT
66 Linear Elastic Discrete Beam	Y				Y			
67 Nonlinear Elastic Discrete Beam	Y				Y		Y	
68 Nonlinear Plastic Discrete Beam	Y	Y			Y			
69 SID Damper Discrete Beam	Y							
70 Hydraulic Gas Damper Discrete Beam	Y							
71 Cable Discrete Beam (Elastic)							Y	cable
72 Concrete Damage (incl. Release III)	Y	Y	Y			Y	Y	SL
73 Low Density Viscous Foam	Y	Y					Y	FM
74 Elastic Spring Discrete Beam	Y	Y					Y	
75 Bilkhu/Dubois Foam							Y	FM
76 General Viscoelastic (Maxwell Model)	Y			Y			Y	RB
77 Hyperelastic and Ogden Rubber	Y						Y	RB
78 Soil Concrete		Y				Y	Y	SL
79 Hysteretic Soil (Elasto-Perfectly Plastic)		Y					Y	SL
80 Ramberg-Osgood								SL
81 Plasticity with Damage	Y	Y				Y		MT, PL
82 Plasticity with Damage Ortho	Y	Y			Y	Y		
83 Fu Chang Foam	Y	Y				Y	Y	FM

Material Number and Description	SRATE	FAIL	EOS	THERMAL	ANISO	DAM	TENS	Applications
84 Winfrith Concrete (w/ rate effects)	Y						Y	FM, SL
85 Winfrith Concrete							Y	SL
86 Orthotropic Viscoelastic	Y				Y			RB
87 Cellular Rubber	Y						Y	RB
88 MTS	Y		Y	Y				MT
89 Plasticity Polymer	Y						Y	PL
90 Acoustic							Y	FL
91 Soft Tissue	Y	Y			Y		Y	BIO
92 Soft Tissue (viscous)								
93 Elastic 6DOF Spring Discrete Beam	Y	Y			Y		Y	
94 Inelastic Spring Discrete Beam	Y	Y					Y	
95 Inelastic 6DOF Spring Discrete Beam	Y	Y			Y		Y	
96 Brittle Damage	Y	Y			Y	Y	Y	SL
97 General Joint Discrete Beam								
98 Simplified Johnson Cook	Y	Y						MT
99 Simpl. Johnson Cook Orthotropic Damage	Y	Y			Y	Y		MT
100 Spotweld	Y	Y				Y	Y	MT (spotwelds)
101 GE Plastic Strain Rate	Y	Y					Y	PL
102 Inv. Hyperbolic Sin	Y			Y				MT, PL
103 Anisotropic Viscoplastic	Y	Y			Y			MT
103P Anisotropic Plastic					Y			MT
104 Damage 1	Y	Y			Y	Y		MT
105 Damage 2	Y	Y				Y		MT
106 Elastic Viscoplastic Thermal	Y			Y				PL
107 Modified Johnson Cook	Y	Y		Y		Y		MT
108 Ortho Elastic Plastic					Y			
110 Johnson Holmquist Ceramics	Y	Y				Y	Y	CR, GL
111 Johnson Holmquist Concrete	Y	Y				Y	Y	SL
112 Finite Elastic Strain Plasticity	Y							PL
113 Transformation Induced Plasticity (TRIP)				Y				MT
114 Layered Linear Plasticity	Y	Y						MT, PL, CM
115 Unified Creep								
116 Composite Layup					Y			CM
117 Composite Matrix					Y			CM
118 Composite Direct					Y			CM
119 General Nonlinear 6DOF Discrete Beam	Y	Y			Y		Y	
120 Gurson	Y	Y				Y	Y	MT

Material Number and Description	SRATE	FAIL	EOS	THERMAL	ANISO	DAM	TENS	Applications
121 General Nonlinear 1DOF Discrete Beam	Y	Y					Y	
122 Hill 3RC					Y			MT
123 Modified Piecewise Linear Plasticity	Y	Y						MT, PL
124 Plasticity Compression Tension	Y	Y					Y	MT, PL
125 Kinematic Hardening Transversely Aniso.					Y			MT
126 Modified Honeycomb	Y	Y			Y	Y	Y	CM, FM, SL
127 Arruda Boyce Rubber	Y							RB
128 Heart Tissue					Y		Y	BIO
129 Lung Tissue	Y						Y	BIO
130 Special Orthotropic					Y			
131 Isotropic Smearred Crack		Y				Y	Y	MT, CM
132 Orthotropic Smearred Crack		Y			Y	Y		MT, CM
133 Barlat YLD2000	Y			Y	Y			MT
134 Viscoelastic Fabric								
135 Weak and Strong Texture Model	Y	Y			Y			MT
136 Corus Vegter					Y			MT
138 Cohesive Mixed Mode		Y			Y	Y	Y	AD
139 Modified Force Limited						Y	Y	
140 Vacuum								
141 Rate Sensitive Polymer	Y							PL
142 Transversely Anisotropic Crushable Foam					Y		Y	FM
143 Wood	Y	Y			Y	Y	Y	(wood)
144 Pitzer Crushable Foam	Y						Y	FM
145 Schwer Murray Cap Model	Y	Y				Y	Y	SL
146 1DOF Generalized Spring	Y							
147 FWHA Soil	Y					Y	Y	SL
147N FHWA Soil Nebraska	Y					Y	Y	SL
148 Gas Mixture				Y				FL
151 Evolving Microstructural Model of Inelast.	Y	Y		Y	Y	Y		MT
153 Damage 3	Y	Y				Y		MT, PL
154 Deshpande Fleck Foam		Y						FM
155 Plasticity Compression Tension EOS	Y	Y	Y				Y	(ice)
156 Muscle	Y						Y	BIO
157 Anisotropic Elastic Plastic					Y			MT, CM
158 Rate-Sensitive Composite Fabric	Y	Y			Y	Y	Y	CM
159 CSCM	Y	Y				Y	Y	SL
160 ALE incompressible								

Material Number and Description	SRATE	FAIL	EOS	THERMAL	ANISO	DAM	TENS	Applications
161,162 Composite MSC	Y	Y			Y	Y	Y	CM
163 Modified Crushable Foam	Y						Y	FM
164 Brain Linear Viscoelastic	Y							BIO
165 Plastic Nonlinear Kinematic		Y						MT
166 Moment Curvature Beam	Y	Y					Y	CIV
167 McCormick	Y							MT
168 Polymer				Y			Y	PL
169 Arup Adhesive	Y	Y			Y		Y	AD
170 Resultant Anisotropic					Y			PL
171 Steel Concentric Brace						Y	Y	CIV
172 Concrete EC2		Y		Y			Y	SL, MT
173 Mohr Coulomb					Y		Y	SL
174 RC Beam						Y	Y	SL
175 Viscoelastic Thermal	Y			Y			Y	RB
176 Quasilinear Viscoelastic	Y	Y				Y	Y	BIO
177 Hill Foam							Y	FM
178 Viscoelastic Hill Foam (Ortho)	Y						Y	FM
179 Low Density Synthetic Foam	Y	Y			Y	Y	Y	FM
181 Simplified Rubber/Foam	Y	Y				Y	Y	RB, FM
183 Simplified Rubber with Damage	Y	Y				Y	Y	RB
184 Cohesive Elastic		Y					Y	AD
185 Cohesive TH		Y			Y	Y	Y	AD
186 Cohesive General		Y			Y	Y	Y	AD
187 Semi-Analytical Model for Polymers – 1	Y	Y				Y		PL
188 Thermo Elasto Viscoelastic Creep	Y			Y				MT
189 Anisotropic Thermoelastic				Y	Y			
190 Flow limit diagram 3-Parameter Barlat		Y			Y		Y	MT
191 Seismic Beam							Y	CIV
192 Soil Brick					Y			SL
193 Drucker Prager							Y	SL
194 RC Shear Wall		Y				Y	Y	CIV
195 Concrete Beam	Y	Y				Y	Y	CIV
196 General Spring Discrete Beam	Y						Y	
197 Seismic Isolator	Y	Y			Y		Y	CIV
198 Jointed Rock		Y			Y		Y	SL
202 Steel EC3								CIV
208 Bolt Beam								

Material Number and Description	SRATE	FAIL	EOS	THERMAL	ANISO	DAM	TENS	Applications
219 CODAM2		Y			Y	Y	Y	CM
220 Rigid Discrete								
221 Orthotropic Simplified Damage		Y			Y	Y	Y	CM
224 Tabulated Johnson Cook	Y	Y	Y	Y		Y	Y	HY, MT, PL
225 Viscoplastic Mixed Hardening	Y	Y						MT, PL
226 Kinematic hardening Barlat 89					Y			MT
230 Elastic Perfectly Matched Layer (PML)	Y							SL
231 Acoustic PML								FL
232 Biot Linear Hysteretic Material	Y							SL
233 Cazacu Barlat					Y		Y	MT
234 Viscoelastic Loose Fabric	Y	Y			Y		Y	Fabric
235 Micromechanic Dry Fabric					Y		Y	Fabric
236 Ceramic Matrix		Y			Y		Y	CM, CR
237 Biot Hysteretic PML	Y							SL
238 Piecewise linear plasticity (PERT)	Y	Y						MT, PL
240 Cohesive mixed mode	Y	Y			Y	Y	Y	AD
241 Johnson Holmquist JH1	Y	Y				Y	Y	CR, GL
242 Kinematic hardening Barlat 2000					Y			MT
243 Hill 90	Y			Y	Y			MT
244 UHS Steel	Y			Y				MT
245 Orthotropic/anisotropic PML	Y							SL
246 Null material PML			Y					FL
255 Piecewise linear plastic thermal	Y	Y		Y			Y	MT
256 Amorphous solid (finite strain)	Y						Y	GL
266 Dispersed tissue					Y			BIO
267 Eight chain rubber	Y				Y			RB, PL
272 RHT concrete model	Y	Y				Y	Y	SL,CIV
276 Chronological viscoelastic	Y			Y				RB
A01 ALE Vacuum								FL
A02 ALE Viscous			Y				Y	FL
A03 ALE Gas Mixture				Y				FL
A04 ALE Herschel			Y				Y	FL
S1 Spring Elastic (Linear)								
S2 Damper Viscous (Linear)	Y							
S3 Spring Elastoplastic (Isotropic)								
S4 Spring Nonlinear Elastic	Y						Y	
S5 Damper Nonlinear Viscous	Y						Y	



Material Number and Description	SRATE	FAIL	EOS	THERMAL	ANISO	DAM	TENS	Applications
<b>S6 Spring General Nonlinear</b>							Y	
<b>S7 Spring Maxwell (3-Parameter Viscoelastic)</b>	Y							
<b>S8 Spring Inelastic (Tension or Compression)</b>							Y	
<b>S13 Spring Trilinear Degrading</b>		Y				Y		CIV
<b>S14 Spring Squat Shearwall</b>						Y		CIV
<b>S15 Spring Muscle</b>	Y						Y	BIO
<b>B1 Seatbelt</b>							Y	
<b>T01 Thermal Isotropic</b>				Y				Heat transfer
<b>T02 Thermal Orthotropic</b>				Y	Y			Heat transfer
<b>T03 Thermal Isotropic (Temp Dependent)</b>				Y				Heat transfer
<b>T04 Thermal Orthotropic (Temp Dependent)</b>				Y	Y			Heat transfer
<b>T05 Thermal Isotropic (Phase Change)</b>				Y				Heat transfer
<b>T06 Thermal Isotropic (Temp dep-load curve)</b>				Y				Heat transfer
<b>T11 Thermal User Defined</b>				Y				Heat transfer

**\*MAT\_ADD\_AIRBAG\_POROSITY\_LEAKAGE**

This command allows users to model porosity leakage through non-fabric material when such material is used as part of control volume, airbag. It applies to both \*AIRBAG\_HYBRID and \*AIRBAG\_WANG\_NEFSKE.

Card 1            1            2            3            4            5            6            7            8

Variable	MID	FLC/X2	FAC/X3	ELA	FVOPT	X0	X1	
Type	I	F	F	F	F	F	F	
Default	none	none	1.0	none	none	none	none	

<u>VARIABLE</u>	<u>DESCRIPTION</u>
-----------------	--------------------

MID	Material ID for which the porosity leakage property applies
-----	---

FLC/X2	<p>If <math>X0 \neq 0, X0 \neq 1</math>: This is X2 coefficient of the porosity equation of Anagonye and Wang [1999]. Else, this is an optional constant, FLC, a fabric porous leakage flow coefficient.</p> <p>LT.0.0: There are two possible definitions.</p> <p>If <math>X0 = 0</math>,  FLC  is the load curve ID of the curve defining FLC versus time.</p> <p>If <math>X0 = 1</math>,  FLC  is the load curve ID defining FLC versus the stretching ratio defined as <math>r_s = A / A_0</math>. See notes below.</p>
--------	---

FAC/X3	<p>If <math>X0 \neq 0, X0 \neq 1</math>: This is X3 coefficient of the porosity equation of Anagonye and Wang [1999]. Else, if and only if <math>X0 = 0</math>: This is an optional constant, FAC, a fabric characteristic parameter.</p> <p>LT.0.0: There are three possible definitions.</p> <p>If <math>FVOPT &lt; 7</math>:</p> <p>If <math>X0 = 0</math>,  FAC  is the load curve ID of the curve defining FAC versus <u>absolute</u> pressure.</p> <p>If <math>X0 = 1</math>,  FAC  is the load curve ID defining FAC versus the pressure ratio defined as <math>r_p = P_{air} / P_{bag}</math>. See remark 3 below.</p> <p>If <math>FVOPT = 7</math> or <math>8</math>:</p> <p>FAC defines leakage volume flux rate versus absolute pressure. The volume flux (per area) rate (per time) has the unit of <math>v\dot{o}l_{flux} \approx m^3 / [m^2 s] \approx m/s</math>, equivalent to relative porous gas speed.</p>
--------	---

VARIABLE	DESCRIPTION
ELA	<p>Effective leakage area for blocked fabric, ELA.</p> <p>LT.0.0:  ELA  is the load curve ID of the curve defining ELA versus time. The default value of zero assumes that no leakage occurs. A value of .10 would assume that 10% of the blocked fabric is leaking gas.</p>
FVOPT	<p>Fabric venting option.</p> <p>EQ.1: Wang-Nefske formulas for venting through an orifice are used. Blockage is not considered.</p> <p>EQ.2: Wang-Nefske formulas for venting through an orifice are used. Blockage of venting area due to contact is considered.</p> <p>EQ.3: Leakage formulas of Graefe, Krummheuer, and Siejak [1990] are used. Blockage is not considered.</p> <p>EQ.4: Leakage formulas of Graefe, Krummheuer, and Siejak [1990] are used. Blockage of venting area due to contact is considered.</p> <p>EQ.5: Leakage formulas based on flow through a porous media are used. Blockage is not considered.</p> <p>EQ.6: Leakage formulas based on flow through a porous media are used. Blockage of venting area due to contact is considered.</p> <p>EQ.7: Leakage is based on gas volume outflow versus pressure load curve [Lian, 2000]. Blockage is not considered. Absolute pressure is used in the porous-velocity-versus-pressure load curve, given as FAC in the *MAT_FABRIC card.</p> <p>EQ.8: Leakage is based on gas volume outflow versus pressure load curve [Lian 2000]. Blockage of venting or porous area due to contact is considered. Absolute pressure is used in the porous-velocity-versus-pressure load curve, given as FAC in the *MAT_FABRIC card.</p>
X0,X1	<p>Coefficients of Anagonye and Wang [1999] porosity equation for the leakage area: <math>A_{leak} = A_0 (X_0 + X_1 r_s + X_2 r_p + X_3 r_s r_p)</math></p>

**\*MAT\_ADD\_EROSION**

Many of the constitutive models in LS-DYNA do not allow failure and erosion. The ADD\_EROSION option provides a way of including failure in these models although the option can also be applied to constitutive models with other failure/erosion criterion. Each of the criterion defined here are applied independently, and once any one of them is satisfied, the element is deleted from the calculation. This option applies to nonlinear element formulations including the 2D continuum, 3D solid elements, 3D shell elements, and the thick shell elements types 1 and 2. Beam types 1 and 11 currently support the erosion but not the damage and evolution models. In addition to erosion, damage initiation and evolution models are available as described in the remarks.

Card 1            1            2            3            4            5            6            7            8

Variable	MID	EXCL	MXPRES	MNEPS	EFFEPS	VOLEPS	NUMFIP	NCS
Type	A8	F	F	F	F	F	F	F
Default	none	none	0.0	0.0	0.0	0.0	1.0	1.0

Card 2            1            2            3            4            5            6            7            8

Variable	MNPRES	SIGP1	SIGVM	MXEPS	EPSSH	SIGTH	IMPULSE	FAILTM
Type	F	F	F	F	F	F	F	F
Default	none	none	none	none	none	none	none	none

**The following card is optional:**

Card 3            1            2            3            4            5            6            7            8

Variable	IDAM	DMGTYP	LCSDG	ECRIT	DMGEXP	DCRIT	FADEXP	LCREGD
Type	A8	F	F	F	F	F	F	F
Default	0.0	0.0	0.0	0.0	1.0	0.0	1.0	0.0

If IDAM.GT.0 define the following card:

Card 4            1            2            3            4            5            6            7            8

Variable	SIZFLG	REFSZ	NAHSV	LCSRS	SHRF	BIAXF		
Type	F	F	F	F	F	F		
Default	0.0	0.0	0.0	0.0	0.0	0.0		

If IDAM.LT.0 then define -IDAM set of cards on the following format:

Card 4            1            2            3            4            5            6            7            8

Variable	DITYP	P1	P2					
Type	F	F	F					
Default	0.0	0.0	0.0					

Card 4            1            2            3            4            5            6            7            8

Variable	DETYP	DCTYP	Q1					
Type	F	F	F					
Default	0.0	0.0	0.0					

**Optional card 4 (IDAM=0) or 5 (IDAM>0) or 4+2\*|IDAM| (IDAM<0):**

Card 4/5/...      1            2            3            4            5            6            7            8

Variable	LCFLD		EPSTHIN					
Type	F		F					
Default	0.0		0.0					

<u>VARIABLE</u>	<u>DESCRIPTION</u>
MID	Material identification for which this erosion definition applies. A unique number or label not exceeding 8 characters must be specified.
EXCL	The exclusion number, which applies to the values defined on Card 2. When any of the failure constants are set to the exclusion number, the associated failure criteria calculations are bypassed (which reduces the cost of the failure model). For example, to prevent a material from going into tension, the user should specify an unusual value for the exclusion number, e.g., 1234., set $P_{min}$ to 0.0 and all the remaining constants to 1234. The default value is 0.0, which eliminates all criteria from consideration that have their constants set to 0.0 or left blank in the input file.
MXPRES	Maximum pressure at failure, $P_{max}$ . If the value is exactly zero, it is automatically excluded to maintain compatibility with old input files.
MNEPS	Minimum principal strain at failure, $\epsilon_{min}$ . If the value is exactly zero, it is automatically excluded to maintain compatibility with old input files.
EFFEPS	Maximum effective strain at failure, $\epsilon_{eff} = \sqrt{2/3 \epsilon_{ij}^{dev} \epsilon_{ij}^{dev}}$ . If the value is exactly zero, it is automatically excluded to maintain compatibility with old input files. If the value is negative, then  EFFEPS  is the effective plastic strain to failure. In combination with cohesive elements, EFFEPS is the maximum effective in-plane strain.
VOLEPS	Volumetric strain at failure, $\epsilon_{vol} = \epsilon_{11} + \epsilon_{22} + \epsilon_{33}$ . VOLEPS can be a positive or negative number depending on whether the failure is in tension or compression, respectively. If the value is exactly zero, it is automatically excluded to maintain compatibility with old input files.

VARIABLE	DESCRIPTION
NUMFIP	Number of failed integration points prior to element deletion. The default is unity. LT.0.0:  NUMFIP  is percentage of integration points/layers which must fail before element fails (only GISSMO). Only for shells.
NCS	Number of failure conditions to satisfy before failure occurs. For example, if SIGP1 and SIGVM are defined and if NCS=2, both failure criteria must be met before element deletion can occur. The default is set to unity.
MNPRES	Minimum pressure at failure, $P_{min}$ .
SIGP1	Principal stress at failure, $\sigma_{max}$ .
SIGVM	Equivalent stress at failure, $\bar{\sigma}_{max}$ .
MXEPS	Maximum principal strain at failure, $\epsilon_{max}$ . The maximum principal strain at failure is made a function of the effective strain rate by setting MXEPS to the negative of the appropriate load curve ID.
EPSSH	Shear strain at failure, $\gamma_{max}$ .
SIGTH	Threshold stress, $\sigma_0$ .
IMPULSE	Stress impulse for failure, $K_f$ .
FAILTM	Failure time. When the problem time exceeds the failure time, the material is removed.
IDAM	Flag for damage model. EQ.0: no damage model is used. EQ.1: GISSMO damage model. LT.0: -IDAM represents the number of damage initiation and evolution criteria to be applied

<b>VARIABLE</b>	<b>DESCRIPTION</b>
DMGTYP	<p>For GISSMO damage type the following applies.</p> <p>EQ.0: Damage is accumulated, no coupling to flow stress, no failure. EQ.1: Damage is accumulated, element failure occurs for D=1. Coupling of damage to flow stress depending on parameters, see remarks below.</p> <p>For IDAM.LT.0 the following applies.</p> <p>EQ.0: No action is taken EQ.1: Damage history is initiated based on values of initial plastic strains and initial strain tensor, this is to be used in multistage analyses</p>
LCSDG	<p>Load curve ID or Table ID. Load curve defines equivalent plastic strain to failure vs. triaxiality. Table defines for each Lode angle value (between -1 and 1) a load curve ID giving the equivalent plastic strain to failure vs. triaxiality for that Lode angle value.</p>
ECRIT	<p>Critical plastic strain (material instability), see below.</p> <p>LT.0.0:  ECRIT  is load curve ID defining critical equivalent plastic strain vs. triaxiality. EQ.0.0: Fixed value DCRIT defining critical damage is read (see below) GT.0.0: Fixed value for stress-state independent critical equivalent plastic strain.</p>
DMGEXP	<p>Exponent for nonlinear damage accumulation, see remarks.</p>
DCRIT	<p>Damage threshold value (critical damage). If a Load curve of critical plastic strain or fixed value is given by ECRIT, input is ignored.</p>
FADEXP	<p>Exponent for damage-related stress fadeout.</p> <p>LT.0.0:  FADEXP  is load curve ID defining element-size dependent fading exponent. GT.0.0: Constant fading exponent.</p>
LCREGD	<p>Load curve ID defining element size dependent regularization factors for equivalent plastic strain to failure.</p>
SIZEFLG	<p>Flag for method of element size determination.</p> <p>EQ.0 (default): Element size is determined in undeformed configuration as square root of element area (shells), or cubic root of element volume (solids), respectively. EQ.1: Element size is updated every time step, and determined as mean edge length. (This option was added to ensure comparability with *MAT_120, and is not recommended for general purpose).</p>



VARIABLE	DESCRIPTION
REFSZ	Reference element size, for which an additional output of damage will be generated. This is necessary to ensure the applicability of resulting damage quantities when transferred to different mesh sizes.
NAHSV	Number of history variables from damage model which should be stored in standard material history array for Postprocessing. See remarks.
LCSRS	Load curve ID defining failure strain scaling factor vs. strain rate. GT.0.: scale ECRIT, too LT.0.: do not scale ECRIT.
SHRF	Reduction factor for regularization at triaxiality=0 (shear)
BIAXF	Reduction factor for regularization at triaxiality=2/3 (biaxial)
DITYP	Damage initiation type EQ.0.0: Ductile EQ.1.0: Shear EQ.2.0: MSFLD
P1	Damage initiation parameter DITYP.EQ.0.0: Load curve/table ID representing plastic strain at onset of damage as function of stress triaxiality and optionally plastic strain rate. DITYP.EQ.1.0: Load curve/table ID representing plastic strain at onset of damage as function of shear influence and optionally plastic strain rate. DITYP.EQ.2.0: Load curve/table ID representing plastic strain at onset of damage as function of ratio of principal plastic strain rates and optionally plastic strain rate.
P2	Damage initiation parameter DITYP.EQ.0.0: Not used DITYP.EQ.1.0: Pressure influence coefficient $k_S$ DITYP.EQ.2.0: Not used
DETYP	Damage evolution type EQ.0.0: Linear softening, evolution of damage is a function of the plastic displacement after the initiation of damage. EQ.1.0: Linear softening, evolution of damage is a function of the fracture energy after the initiation of damage.
DCTYP	Damage composition option for multiple criteria EQ.0.0: Maximum EQ.1.0: Multiplicative

VARIABLE	DESCRIPTION
Q1	Damage evolution parameter DETYP.EQ.0.0: Plastic displacement at failure, $u_f^p$ . DETYP.EQ.1.0: Fracture energy at failure, $G_f$ .
LCFLD	Load curve ID defining the Forming Limit Diagram. Minor strains in percent are defined as abscissa values and Major strains in percent are defined as ordinate values. The forming limit diagram is shown in Figure 39.1. In defining the curve, list pairs of minor and major strains starting with the left most point and ending with the right most point. This criterion is only for shell elements and it is available starting with Release 971 R6.
EPSTHIN	Thinning strain at failure for thin and thick shells.

The criteria for failure besides failure time are:

1.  $P \geq P_{max}$ , where  $P$  is the pressure (positive in compression), and  $P_{max}$  is the maximum pressure at failure.
2.  $\epsilon_3 \leq \epsilon_{min}$ , where  $\epsilon_3$  is the minimum principal strain, and  $\epsilon_{min}$  is the minimum principal strain at failure.
3.  $P \leq P_{min}$ , where  $P$  is the pressure (positive in compression), and  $P_{min}$  is the minimum pressure at failure.
4.  $\sigma_1 \geq \sigma_{max}$ , where  $\sigma_1$  is the maximum principal stress, and  $\sigma_{max}$  is the maximum principal stress at failure.
5.  $\sqrt{\frac{3}{2} \sigma'_{ij} \sigma'_{ij}} \geq \bar{\sigma}_{max}$ , where  $\sigma'_{ij}$  are the deviatoric stress components, and  $\bar{\sigma}_{max}$  is the equivalent stress at failure.
6.  $\epsilon_1 \geq \epsilon_{max}$ , where  $\epsilon_1$  is the maximum principal strain, and  $\epsilon_{max}$  is the maximum principal strain at failure.
7.  $\gamma_1 \geq \gamma_{max}$ , where  $\gamma_1$  is the maximum shear strain =  $(\epsilon_1 - \epsilon_3) / 2$ , and  $\gamma_{max}$  is the shear strain at failure.
8. The Tuler-Butcher criterion,

$$\int_0^t [\max(0, \sigma_1 - \sigma_0)]^2 dt \geq K_f,$$

where  $\sigma_1$  is the maximum principal stress,  $\sigma_0$  is a specified threshold stress,  $\sigma_1 \geq \sigma_0 \geq 0$ , and  $K_f$  is the stress impulse for failure. Stress values below the threshold value are too low to cause fracture even for very long duration loadings.

**Remarks on Damage Models:**

**GISSMO**

The GISSMO damage model is a phenomenological formulation that allows for an incremental description of damage accumulation, including softening and failure. It is intended to provide a maximum in variability for the description of damage for a variety of metallic materials (e.g. \*MAT\_024, \*MAT\_036, ...). The input of parameters is based on tabulated data, allowing the user to directly convert test data to numerical input.

The model is based on an incremental formulation of damage accumulation:

$$\Delta D = \frac{DMGEXP}{\epsilon_f} D^{\left(1 - \frac{1}{DMGEXP}\right)} \Delta \epsilon_p$$

with

- D: Damage value ( $0 \leq D \leq 1$ ). For numerical reasons, D is initialized to a value of 1.E-20 for all damage types in the first time step
- $\epsilon_f$ : Equivalent plastic strain to failure, determined from LCSDG as a function of the current triaxiality value  $\eta$ . A typical failure curve LCSDG for metal sheet, modeled with shell elements is shown in Figure 0.1. Triaxiality should be monotonically increasing in this curve. A reasonable range for triaxiality is -2/3 to 2/3 if shell elements are used (plane stress). For 3-dimensional stress states (solid elements), the possible range of triaxiality goes from  $-\infty$  to  $+\infty$ , but to get a good resolution in the internal load curve discretization (depending on parameter LCINT of \*CONTROL\_SOLUTION) one should define lower limits, e.g. -1 to 1 if LCINT=100 (default).
- $\Delta \epsilon_p$ : Equivalent plastic strain increment

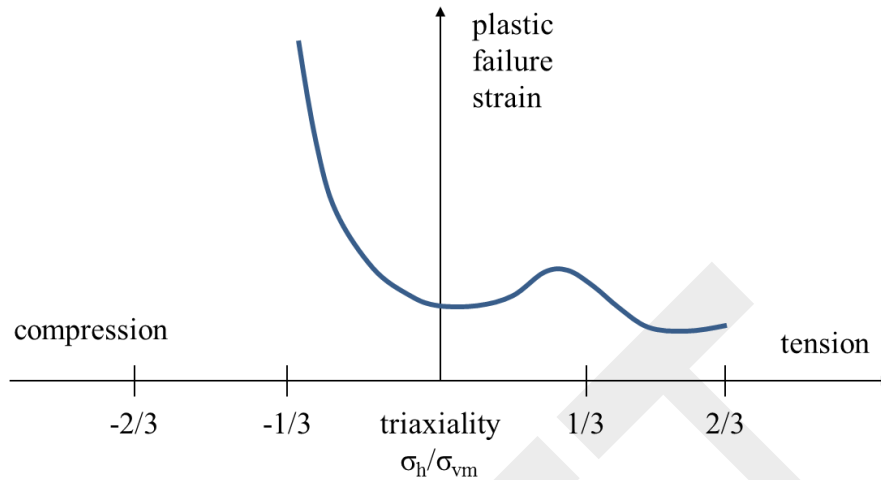

**Figure 0.1.** Typical failure curve for metal sheet, modeled with shell elements.

For constant values of failure strain, this damage rate can be integrated to get a relation of damage and actual equivalent plastic strain:

$$D = \left( \frac{\epsilon_p}{\epsilon_f} \right)^{DMGEXP} \quad \text{for } \epsilon_f = \text{const. only!}$$

Triaxiality  $\eta$  as a measure of the current stress state is defined as

$$\eta = \frac{\sigma_H}{\sigma_M} \quad \text{with hydrostatic stress } \sigma_H \text{ and equivalent von Mises stress } \sigma_M.$$

For DMGTYP.EQ.0, damage is accumulated according to the description above, yet no softening and failure is taken into account. Thus, parameters ECRIT, DCRIT and FADEXP will not have any influence. This option can be used to calculate pre-damage in multi-stage deformations without influencing the simulation results.

For DMGTYP.EQ.1, elements will be deleted if  $D \geq 1$ .

Depending on the set of parameters given by ECRIT (or DCRIT) and FADEXP, a Lemaitre-type coupling of damage and stress (*effective stress concept*) can be used.

Three principal ways of damage definition can be used:

- 1.) Input of a fixed value of critical plastic strain (ECRIT.GT.0.)

As soon as the magnitude of plastic strain reaches this value, the current damage parameter D is stored as critical damage DCRIT and the damage coupling flag is set to unity, in order to facilitate an identification of critical elements in postprocessing. From this point on, damage is coupled to the stress tensor using the following relation:

$$\sigma = \tilde{\sigma} \left( 1 - \left( \frac{D - DCRIT}{1 - DCRIT} \right)^{FADEXP} \right)$$

This leads to a continuous reduction of stress, up to the load-bearing capacity completely vanishing as D reaches unity. The fading exponent FADEXP can be defined element size dependent, to allow for the consideration of an element-size dependent amount of energy to be dissipated during element fade-out.

2.) Input of a load curve defining critical plastic strain vs. triaxiality (ECRIT.LT.0.), pointing to load curve ID [ECRIT]. This allows for a definition of triaxiality-dependent material instability, which takes account of that instability and localization will occur depending on the actual load case. This offers the possibility to use a transformed Forming Limit Diagram as an input for the expected onset of softening and localization. Using this load curve, the instability measure F is accumulated using the following relation, which is similar to the accumulation of damage D except for the instability curve is used as an input:

$$\Delta F = \frac{DMGEXP}{\varepsilon_{p,loc}} F^{\left(1 - \frac{1}{DMGEXP}\right)} \Delta \varepsilon_p$$

with F: Instability measure ( $0 \leq F \leq 1$ ).

$\varepsilon_{p,loc}$ : Equivalent plastic strain to instability, determined from ECRIT

$\Delta \varepsilon_p$ : Equivalent plastic strain increment

As soon as the instability measure F reaches unity, the current value of damage D in the respective element is stored. Damage will from this point on be coupled to the flow stress using the relation described above

3.) If no input for ECRIT is made, parameter DCRIT will be considered.

Coupling of Damage to the stress tensor starts if this value (*damage threshold*) is exceeded ( $0 \leq DCRIT \leq 1$ ). Coupling of damage to stress is done using the relation described above.

This input allows for the use of extreme values also – for example, DCRIT.EQ.0.0 would lead to no coupling at all, and element deletion under full load (brittle fracture).

#### History Variables:

History variables of the GISSMO damage model are written to the postprocessing database only if NAHSV>0. The damage history variables start at position ND, which is displayed in d3hsp file, e.g. “first damage history variable = 6” means that ND=6.

<i>Variable</i>	<i>Description</i>
ND	Damage parameter D ( $1.E-20 \leq D \leq 1$ )
ND+1	Damage threshold DCRIT

ND+2	Domain flag for damage coupling (0: no coupling, 1: coupling)
ND+3	Triaxiality variable $\sigma_H / \sigma_M$
ND+4	Equivalent plastic strain
ND+5	Regularization factor for failure strain (determined from LCREGD)
ND+6	Exponent for stress fading FADEXP
ND+7	Calculated element size
ND+8	Instability measure F
ND+9	Resultant damage parameter D for element size REFSZ
ND+10	Resultant damage threshold DCRIT for element size REFSZ
ND+11	Averaged triaxiality
ND+12	Lode angle value
ND+13	Alternative damage value: $D^{1/DMGEXP}$

### Damage initiation and evolution criteria

As an alternative to GISSMO, the user may invoke an arbitrary number of damage initiation and evolution criteria, the number of course in practice being limited by the number of available criteria. With this option the following theory applies.

Assuming that  $n$  initiation/evolution types have been defined according to the information above,  $n$  being the same as –IDAM above, damage initiation and evolution history variables  $\omega_D^i \in [0, \infty[$  and  $D^i \in [0, 1]$ ,  $i=1, \dots, n$ , are introduced for each integration point. These are initially set to zero and then evolve with the deformation of the elements according to rules associated with the specific damage initiation and evolution type chosen, see below for details. The variables can be post-processed just as ordinary material history variables and their positions in the history variables array is given in d3hsp, search for the string *Damage history listing*. The damage initiation variables do not influence the results but just serve as an indicator for the onset of damage. The damage evolution variables govern the damage in the material and are used to form the global damage  $D \in [0, 1]$ . When multiple criteria are active,  $n > 1$ , each individual criterion can be of maximum,  $i \in I_{\max}$ , or multiplicative,  $i \in I_{\text{mult}}$ , type, this is defined by the DCTYP parameter. The global damage variable is defined as

$$D = \max(D_{\max}, D_{\text{mult}})$$

where

$$D_{\max} = \max_{i \in I_{\max}} D^i$$

$$D_{\text{mult}} = 1 - \prod_{i \in I_{\text{mult}}} (1 - D^i)$$

The damage variable relates the macroscopic (damaged) and microscopic (true) stress according to

$$\sigma = (1 - D)\tilde{\sigma}.$$

Once the damage has reached the level of  $D_{\text{erode}}$  (=0.99 by default) the stress is set to zero and the integration point is assumed failed, thus not processed after that. When NUMFIP integration points have failed the element is eroded and removed from the finite element model.

Now to the evolution of the individual damage initiation and evolution history variables, and for the sake of clarity we skip the superscript  $i$  from now on.

The variables  $\omega_D$  governs the onset of damage and evolves independently of each other and according to the following.

*Ductile (DITYP.EQ.0):*

For the ductile initiation option a function  $\varepsilon_D^p = \varepsilon_D^p(\eta, \dot{\varepsilon}^p)$  represents the plastic strain at onset of damage (P1). This is a function of stress triaxiality defined as

$$\eta = -p / q$$

with  $p$  being the pressure and  $q$  the von Mises equivalent stress. Optionally this can be defined as a table with the second dependency being on the effective plastic strain rate  $\dot{\varepsilon}^p$ . The damage initiation history variable evolves according to

$$\omega_D = \int_0^{\varepsilon^p} \frac{d\varepsilon^p}{\varepsilon_D^p}.$$

*Shear (DITYP.EQ.1):*

For the shear initiation option a function  $\varepsilon_D^p = \varepsilon_D^p(\theta, \dot{\varepsilon}^p)$  represents the plastic strain at onset of damage (P1). This is a function of a shear stress function defined as

$$\theta = (q + k_s p) / \tau$$

with  $p$  being the pressure,  $q$  the von Mises equivalent stress and  $\tau$  the maximum shear stress defined as a function of the principal stress values

$$\tau = (\sigma_{\text{major}} - \sigma_{\text{minor}}) / 2.$$

Introduced here is also the pressure influence parameter  $k_s$  (P2). Optionally this can be defined as a table with the second dependency being on the effective plastic strain rate  $\dot{\varepsilon}^p$ . The damage initiation history variable evolves according to

$$\omega_D = \int_0^{\varepsilon^p} \frac{d\varepsilon^p}{\varepsilon_D^p}.$$

*MSFLD (DITYP.EQ.2):*

For the MSFLD initiation option a function  $\varepsilon_D^p = \varepsilon_D^p(\alpha, \dot{\varepsilon}^p)$  represents the plastic strain at onset of damage (P1). This is a function of the ratio of principal plastic strain rates defined as

$$\alpha = \dot{\varepsilon}_{\text{minor}}^p / \dot{\varepsilon}_{\text{major}}^p.$$

The MSFLD criterion is only relevant for shells and the principal strains should be interpreted as the in-plane principal strains. For simplicity the plastic strain evolution in this formula is assumed to stem from an associated von Mises flow rule and whence

$$\alpha = s_{\text{minor}} / s_{\text{major}}$$

with  $s$  being the deviatoric stress. This assures that the calculation of  $\alpha$  is in a sense robust at the expense of being slightly off for materials with anisotropic yield functions and/or non-associated flow rules. Optionally this can be defined as a table with the second dependency being on the effective plastic strain rate  $\dot{\varepsilon}^p$ , for  $\dot{\varepsilon}^p = 0$  the value of  $\varepsilon_D^p$  is set to a large number to prevent onset of damage for no plastic evolution. The damage initiation history variable evolves according to

$$\omega_D = \max_{t \leq T} \frac{\varepsilon^p}{\varepsilon_D^p},$$

which should be interpreted as the maximum value up to this point in time. An important note with this initiation option is that the damage initiation variable is evaluated using the strains and stresses at the mid-surface of the shell and thus bending effects are not taken into account.

For the evolution of the associated damage variable  $D$  we introduce the plastic displacement  $u^p$  which evolves according to

$$\dot{u}^p = \begin{cases} 0 & \omega_D < 1 \\ l \dot{\varepsilon}^p & \omega_D \geq 1 \end{cases}$$

with  $l$  being a characteristic length of the element. Fracture energy is related to plastic displacement as follows

$$G_f = \int_0^{u_f^p} \sigma_y du^p$$

with  $\sigma_y$  being the yield stress. The following defines the evolution of the damage variable.



*Linear (DETYP.EQ.0):*

With this option the damage variable evolves linearly with the plastic displacement

$$\dot{D} = \dot{u}^p / u_f^p$$

with  $u_f^p$  being the plastic displacement at failure (Q1).

*Linear (DETYP.EQ.1):*

With this option the damage variable evolves linearly as follows

$$\dot{D} = \dot{u}^p / u_f^p$$

with  $u_f^p = 2G_t / \sigma_{y0}$  and  $\sigma_{y0}$  being the yield stress when failure criterion is reached.

**\*MAT\_ADD\_PERMEABILITY**

For consolidation calculations.

Card 1            1            2            3            4            5            6            7            8

Variable	MID	PERM	(blank)	(blank)	THEXP	LCKZ		
Type	I	F			F	I		
Default	none	none			0.0	none		

<u>VARIABLE</u>	<u>DESCRIPTION</u>
MID	Material identification – must be same as the structural material.
PERM	Permeability
THEXP	Undrained volumetric thermal expansion coefficient (Units: 1/temperature)
LCKZ	Loadcurve giving factor on PERM versus z-coordinate. (X-axis – z-coordinate, yaxis – non dimensional factor)

**Remarks:**

The units of PERM are length/time (volume flow rate of water per unit area per gradient of head of excess pore pressure head).

See notes under \*CONTROL\_PORE\_FLUID

**\*MAT\_ADD\_PORE\_AIR**

For pore air pressure calculations.

Card 1            1            2            3            4            5            6            7            8

Variable	MID	PA_RHO	PA_PRE	PORE				
Type	I	I	F	F				
Default	None	*	*	1.				
Remarks	1			1,2				

Card 2            1            2            3            4            5            6            7            8

Variable	PERM1	PERM1	PERM3	CDARCY	CDF	LCPGD1	LCPGD2	LCPGD3
Type	F	F	F	F	F	I	I	I
Default	0.	PERM1	PERM1	1.	0.	None	LCPGD1	LCPGD1
Remarks	2,3,4,5	2,3,4,5	2,3,4,5	1	1,5	6	6	6

<u>VARIABLE</u>	<u>DESCRIPTION</u>
MID	Material identification – must be same as the structural material.
PA_RHO	Initial density of pore air, default to atmospheric air density, AIR_RO, defined in *CONTROL_PORE_AIR
PA_PRE	Initial pressure of pore air, default to atmospheric air pressure, AIR_P, defined in *CONTROL_PORE_AIR
PORE	Porosity, ratio of pores to total volume, default to 1.
PERM1~3	Permeability of pore air along x, y and z-direction, <0 when its absolute magnitude is the curve defining permeability coefficient as a function of volume ratio, current-volume/volume-at-stress-free-state.

<b>VARIABLE</b>	<b>DESCRIPTION</b>
CDARCY	Coefficient of Darcy's law
CDF	Coefficient of Dupuit-Forchheimer law

**Remarks:**

1. This card must be defined for all materials requiring consideration of pore air pressure. The pressure contribution of pore air is  $(\rho - \rho_{\text{atm}}) * RT * \text{PORE}$ , where  $\rho$  and  $\rho_{\text{atm}}$  are the current and atmospheric air density,  $R$  is air's gas constant,  $T$  is atmospheric air temperature and  $\text{PORE}$  is the porosity. All  $R$ ,  $T$  and  $\text{VAR}$  are assumed to be constant during simulation.

2. The unit of  $\text{PERM}_i$  is  $\text{length}^3 * \text{time} / \text{mass}$ , (air flow velocity per gradient of excess pore pressure), i.e.

$$(\text{CDARCY} + \text{CDF} * \|\mathbf{v}_{\text{ai}}\|) * \text{PORE} * \mathbf{v}_{\text{ai}} = \text{PERM}_i * \partial P_a / \partial x_i, \quad i=1,2,3$$

where  $\mathbf{v}_{\text{ai}}$  is the pore air flow velocity along the  $i$ 'th direction,  $\partial P_a / \partial x_i$  is the pore air pressure gradient along the  $i$ 'th direction, and  $x_1=x$ ,  $x_2=y$ ,  $x_3=z$ .

3.  $\text{PERM}_2$  and  $\text{PERM}_3$  are assumed to be equal to  $\text{PERM}_1$  when they are not defined. A definition of "0" means no permeability.

4.  $(x,y,z)$ , or  $(1,2,3)$ , refers to material fiber direction when  $\text{MID}$  is an orthotropic material, like  $\text{mat002}$  and  $\text{mat142}$ ; otherwise it refers to global coordinate system.

5.  $\text{CDF}$  can be used to consider the viscosity effect for high speed air flow

6.  $\text{LCGDC}_i$  can be used to define a non-linear Darcy's law as follows:

$$(\text{CDARCY} + \text{CDF} * \|\mathbf{v}_{\text{ai}}\|) * \text{PORE} * \mathbf{v}_{\text{ai}} = \text{PERM} * f_i (\partial P_a / \partial x_i), \quad i=1\sim 3,$$

where  $f_i$  is the function value of  $\text{LCPGD}_i$ . The linear Darcy's law, Remarks 2, can be recovered when  $\text{LCPGD}_i$  are defined as straight lines with a slope of 1.

**\*MAT\_ADD\_THERMAL\_EXPANSION**

The ADD\_THERMAL\_EXPANSION option is used to occupy an arbitrary material model in LS-DYNA with a thermal expansion property. This option applies to all nonlinear solid, shell, thick shell and beam elements and all material models except those models which use resultant formulations such as \*MAT\_RESULTANT\_PLASTICITY and \*MAT\_SPECIAL\_ORTHO-TROPIC. Orthotropic expansion effects are supported for anisotropic materials.

Card 1                    1                    2                    3                    4                    5                    6                    7                    8

Variable	PID	LCID	MULT	LCIDY	MULTY	LCIDZ	MULTZ	
Type	I	I	F	I	F	I	F	
Default	none	none	1.0	LCID	MULT	LCID	MULT	

**VARIABLE****DESCRIPTION**

PID	Part ID for which the thermal expansion property applies
LCID	Load curve ID defining thermal expansion coefficient in local x-direction as a function of temperature. If zero, the thermal expansion coefficient in local x-direction given by constant MULT .
MULT	Scale factor scaling load curve given by LCID
LCIDY	Load curve ID defining thermal expansion coefficient in local y-direction as a function of temperature. If zero, the thermal expansion coefficient in local y-direction given by constant MULTY, if MULTY=0 as well, the properties in x-direction are used.
MULTY	Scale factor scaling load curve given by LCIDY
LCIDZ	Load curve ID defining thermal expansion coefficient in local z-direction as a function of temperature. If zero, the thermal expansion coefficient in local z-direction given by constant MULTZ, if MULTZ=0 as well, the properties in x-direction are used.
MULTZ	Scale factor scaling load curve given by LCIDZ

**Remarks:**

When invoking the isotropic thermal expansion property (no use of the local y and z parameters) for a material, the stress update is based on the elastic strain rates given by

$$\dot{\varepsilon}_{ij}^e = \dot{\varepsilon}_{ij} - \alpha(T)\dot{T}\delta_{ij}$$

rather than on the total strain rates  $\dot{\varepsilon}_{ij}$ . For a material with the stress based on the deformation gradient  $F_{ij}$ , the elastic part of the deformation gradient is used for the stress computations

$$F_{ij}^e = J_T^{-1/3} F_{ij}$$

where  $J_T$  is the thermal Jacobian. The thermal Jacobian is updated using the rate given by

$$\dot{J}_T = 3\alpha(T)\dot{T}J_T.$$

For orthotropic properties, which apply only to materials with anisotropy, these equations are generalized to

$$\dot{\varepsilon}_{ij}^e = \dot{\varepsilon}_{ij} - \alpha_k(T)\dot{T}q_{ik}q_{jk}$$

and

$$F_{ij}^e = F_{ik}\beta_l^{-1}Q_{kl}Q_{jl}$$

where the  $\beta_i$  are updated as

$$\dot{\beta}_i = \alpha_i(T)\dot{T}\beta_i.$$

Here  $q_{ij}$  represents the matrix with material directions with respect to the current configuration whereas  $Q_{ij}$  are the corresponding directions with respect to the initial configuration. For (shell) materials with multiple layers of different anisotropy directions, the mid surface layer determines the orthotropy for the thermal expansion.

\*MAT\_NONLOCAL

In nonlocal failure theories, the failure criterion depends on the state of the material within a radius of influence which surrounds the integration point. An advantage of nonlocal failure is that mesh size sensitivity on failure is greatly reduced leading to results which converge to a unique solution as the mesh is refined. Without a nonlocal criterion, strains will tend to localize randomly with mesh refinement leading to results which can change significantly from mesh to mesh. The nonlocal failure treatment can be a great help in predicting the onset and the evolution of material failure. This option can be used with two and three-dimensional solid elements, and three-dimensional shell elements and thick shell elements. This option applies to a subset of elastoplastic materials that include a damage-based failure criterion.

Card 1            1            2            3            4            5            6            7            8

Variable	IDNL	PID	P	Q	L	NFREQ	NHV	
Type	I	I	F	F	F	I	I	
Default	none	none	none	none	none	none	none	

**Define as many as needed to input NHV variables. One card 2 will be read even if NHV=0.**

Card 2            1            2            3            4            5            6            7            8

Variable	NL1	NL2	NL3	NL4	NL5	NL6	NL7	NL8
Type	I	I	I	I	I	I	I	I
Default	none	none	none	none	none	none	none	none

Define one card for each symmetry plane. Up to six symmetry planes can be defined. The next "\*" card terminates this input.

Cards 3,...      1            2            3            4            5            6            7            8

Variable	XC1	YC1	ZC1	XC2	YC2	ZC2		
Type	F	F	F	F	F	F		
Default	none	none	none	none	none	none		

<u>VARIABLE</u>	<u>DESCRIPTION</u>
IDNL	Nonlocal material input ID.
PID	Part ID for nonlocal material.
P	Exponent of weighting function. A typical value might be 8 depending somewhat on the choice of L. See equations below.
Q	Exponent of weighting function. A typical value might be 2. See equations below.
L	Characteristic length. This length should span a few elements. See equations below.
NFREQ	Number of time steps between update of neighbors. The nearest neighbor search can add significant computational time so it is suggested that NFREQ be set to value of 10 to 100 depending on the problem. This parameter may be somewhat problem dependent.
NHV	Define the number of history variables to be smoothed.
NL1,...,NL8	Define up to eight history variable ID's per line for nonlocal treatment.
XC1, YC1,ZC1	Coordinate of point on symmetry plane.
XC2, YC2, ZC2	Coordinate of a point along the normal vector.

**Remarks:**

For elastoplastic material models in LS-DYNA which use the plastic strain as a failure criterion, the first history variable, which does not count the six stress components, is the plastic strain. In this case, the variable NL1=1 and NL2 to NL8=0. See the table below, which lists the history variable ID's for a subset of materials.



Material Model Name	Effective Plastic Strain Location	Damage Parameter Location
PLASTIC_KINEMATIC	1	N/A
JOHNSON_COOK	1	5 (shells); 7 (solids)
PIECEWISE_LINEAR_PLASTICITY	1	N/A
PLASTICITY_WITH_DAMAGE	1	2
MODIFIED_ZERILLI-ARMSTRONG	1	N/A
DAMAGE_1	1	4
DAMAGE_2	1	2
MODIFIED_PIECEWISE_LINEAR_PLAST	1	N/A
PLASTICITY_COMPRESSION_TENSION	1	N/A
JOHNSON_HOLMQUIST_CONCRETE	1	2
GURSON	1	2

In applying the nonlocal equations to shell and thick shell elements, integration points lying in the same plane within the radius determined by the characteristic length are considered. Therefore, it is important to define the connectivity of the shell elements consistently within the part ID, e.g., so that the outer integration points lie on the same surface.

The equations and our implementation are based on the implementation by Worswick and Lalbin [1999] of the nonlocal theory to Pijaudier-Cabot and Bazant [1987]. Let  $\Omega_r$  be the neighborhood of radius,  $L$ , of element  $e_r$  and  $\{e_i\}_{i=1,\dots,N_r}$  the list of elements included in  $\Omega_r$ , then

$$\hat{f}_r = \hat{f}(x_r) = \frac{1}{W_r} \int_{\Omega_r} \hat{f}_{local} w(x_r - y) dy \approx \frac{1}{W_r} \sum_{i=1}^{N_r} \hat{f}_{local}^i w_{ri} V_i$$

where

$$W_r = W(x_r) = \int w(x_r - y) dy \approx \sum_{i=1}^{N_r} w_{ri} V_i$$

$$w_{ri} = w(x_r - y_i) = \frac{1}{\left[1 + \left(\frac{\|x_r - y_i\|}{L}\right)^p\right]^q}$$

Here  $\dot{f}_r$  and  $x_r$  are respectively the nonlocal rate of increase of damage and the center of the element  $e_r$ , and  $\dot{f}_{local}^i$ ,  $V_i$  and  $y_i$  are respectively the local rate of increase of damage, the volume and the center of element  $e_i$ .

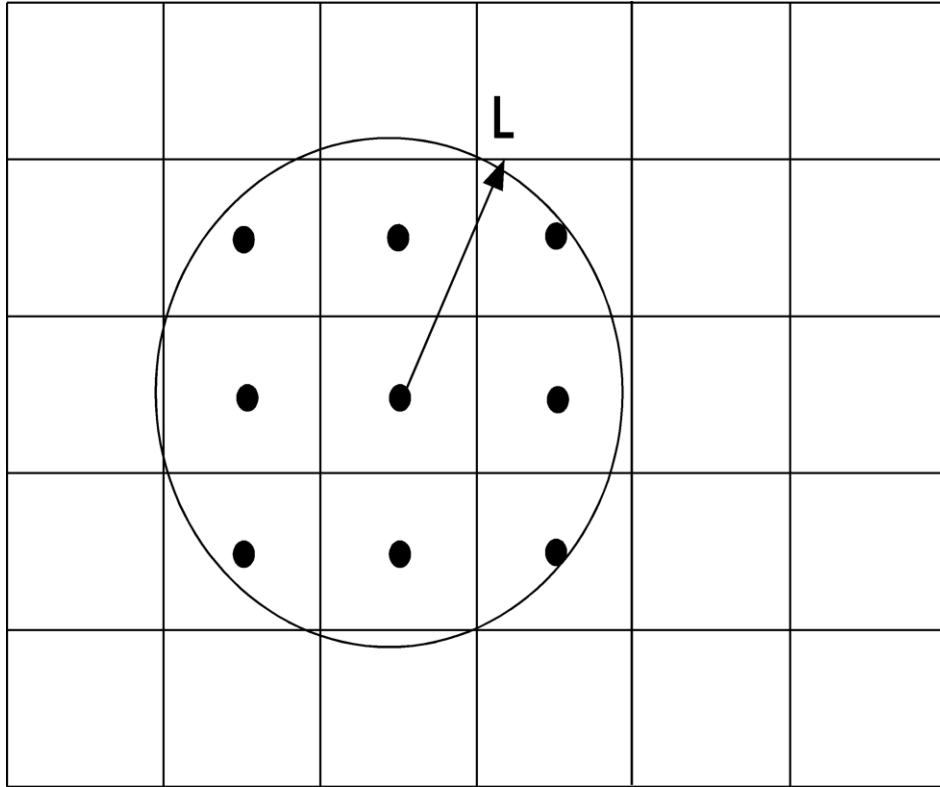

\*MAT\_ELASTIC\_{OPTION}

This is Material Type 1. This is an isotropic hypoelastic material and is available for beam, shell, and solid elements in LS-DYNA. A specialization of this material allows the modeling of fluids.

Available options include:

<BLANK>

FLUID

such that the keyword cards appear:

\*MAT\_ELASTIC or MAT\_001

\*MAT\_ELASTIC\_FLUID or MAT\_001\_FLUID

The fluid option is valid for solid elements only.

Card 1            1            2            3            4            5            6            7            8

Variable	MID	RO	E	PR	DA	DB	K	
Type	A8	F	F	F	F	F	F	
Default	none	none	none	none	0.0	0.0	0.0	

Define the following extra card for the FLUID option:

Card 2            1            2            3            4            5            6            7            8

Variable	VC	CP						
Type	F	F						
Default	none	1.0E+20						

<u>VARIABLE</u>	<u>DESCRIPTION</u>
MID	Material identification. A unique number or label not exceeding 8 characters must be specified.

VARIABLE	DESCRIPTION
RO	Mass density.
E	Young's modulus.
PR	Poisson's ratio.
DA	Axial damping factor (used for Belytschko-Schwer beam, type 2, only).
DB	Bending damping factor (used for Belytschko-Schwer beam, type 2, only).
K	Bulk Modulus (define for fluid option only).
VC	Tensor viscosity coefficient, values between .1 and .5 should be okay.
CP	Cavitation pressure (default = 1.0e+20).

**Remarks:**

This hypoelastic material model may not be stable for finite (large) strains. If large strains are expected, a hyperelastic material model, e.g., \*MAT\_002, would be more appropriate.

The axial and bending damping factors are used to damp down numerical noise. The update of the force resultants,  $F_i$ , and moment resultants,  $M_i$ , includes the damping factors:

$$F_i^{n+1} = F_i^n + \left(1 + \frac{DA}{\Delta t}\right) \Delta F_i^{n+\frac{1}{2}}$$

$$M_i^{n+1} = M_i^n + \left(1 + \frac{DB}{\Delta t}\right) \Delta M_i^{n+\frac{1}{2}}$$

The history variable labeled as "plastic strain" by LS-PrePost is actually volumetric strain in the case of \*MAT\_ELASTIC.

For the fluid option the bulk modulus (K) has to be defined as Young's modulus and Poisson's ratio is ignored. With the fluid option fluid-like behavior is obtained where the bulk modulus, K, and pressure rate, p, are given by:

$$K = \frac{E}{3(1-2\nu)}$$

$$\dot{p} = -K \dot{\epsilon}_{ii}$$

and the shear modulus is set to zero. A tensor viscosity is used which acts only the deviatoric stresses,  $S_{ij}^{n+1}$ , given in terms of the damping coefficient as:

$$S_{ij}^{n+1} = VC \cdot \Delta L \cdot a \cdot \rho \dot{\epsilon}'_{ij}$$

where  $\Delta L$  is a characteristic element length,  $a$  is the fluid bulk sound speed,  $\rho$  is the fluid density, and  $\dot{\epsilon}'_{ij}$  is the deviatoric strain rate.

DRAFT

**\*MAT\_{OPTION}TROPIC\_ELASTIC**

This is Material Type 2. This Total-Lagrangian-based material is valid for modeling the elastic-orthotropic behavior of solids, shells, and thick shells. An anisotropic option is available for solid elements. For orthotropic solids an isotropic frictional damping is available.

Available options include:

**ORTHO**

**ANISO**

such that the keyword cards appear:

**\*MAT\_ORTHOTROPIC\_ELASTIC or MAT\_002** (4 cards follow)

**\*MAT\_ANISOTROPIC\_ELASTIC or MAT\_002\_ANIS** (5 cards follow)

**Cards 1 and 2 for the ORTHO option.**

Card 1            1            2            3            4            5            6            7            8

Variable	MID	RO	EA	EB	EC	PRBA	PRCA	PRCB
Type	A8	F	F	F	F	F	F	F

Card 2            1            2            3            4            5            6            7            8

Variable	GAB	GBC	GCA	AOPT	G	SIGF		
Type	F	F	F	F	F	F		

**Cards 1, 2, and 3 for the ANISO option.**

Card 1            1            2            3            4            5            6            7            8

Variable	MID	RO	C11	C12	C22	C13	C23	C33
Type	A8	F	F	F	F	F	F	F

Card 2            1            2            3            4            5            6            7            8

Variable	C14	C24	C34	C44	C15	C25	C35	C45
Type	F	F	F	F	F	F	F	F

Card 3            1            2            3            4            5            6            7            8

Variable	C55	C16	C26	C36	C46	C56	C66	AOPT
Type	F	F	F	F	F	F	F	F

**Cards 3/4 and 4/5 for the ORTHO/ANISO options.**

Card 3/4        1            2            3            4            5            6            7            8

Variable	XP	YP	ZP	A1	A2	A3	MACF	
Type	F	F	F	F	F	F	I	

Card 4/5        1            2            3            4            5            6            7            8

Variable	V1	V2	V3	D1	D2	D3	BETA	REF
Type	F	F	F	F	F	F	F	F

**VARIABLE**

**DESCRIPTION**

MID            Material identification. A unique number or label not exceeding 8 characters must be specified.

RO            Mass density.

**Define for the ORTHO option only:**

EA             $E_a$ , Young's modulus in a-direction.

<b>VARIABLE</b>	<b>DESCRIPTION</b>
EB	$E_b$ , Young's modulus in b-direction.
EC	$E_c$ , Young's modulus in c-direction (nonzero value required but not used for shells).
PRBA	$\nu_{ba}$ , Poisson's ratio ba.
PRCA	$\nu_{ca}$ , Poisson's ratio ca.
PRCB	$\nu_{cb}$ , Poisson's ratio cb.
GAB	$G_{ab}$ , shear modulus ab.
GBC	$G_{bc}$ , shear modulus bc.
GCA	$G_{ca}$ , shear modulus ca.

**Due to symmetry define the upper triangular  $C_{ij}$ 's for the ANISO option only:**

C11	The 1,1 term in the $6 \times 6$ anisotropic constitutive matrix. Note that 1 corresponds to the $a$ material direction
C12	The 1,2 term in the $6 \times 6$ anisotropic constitutive matrix. Note that 2 corresponds to the $b$ material direction
.	.
.	.
.	.
C66	The 6,6 term in the $6 \times 6$ anisotropic constitutive matrix.

**Define AOPT for both options:**

AOPT	Material axes option, see Figure 2.1. EQ.0.0: locally orthotropic with material axes determined by element nodes as shown in Figure 2.1. Nodes 1, 2, and 4 of an element are identical to the nodes used for the definition of a coordinate system as by *DEFINE_COORDINATE_NODES. When this option is used in two-dimensional planar and axisymmetric analysis, it is critical that the nodes in the element definition be numbered counterclockwise for this option to work correctly. EQ.1.0: locally orthotropic with material axes determined by a point in space and the global location of the element center; this is the $a$ -direction. This option is for solid elements only.
------	---



VARIABLE	DESCRIPTION
	<p>EQ.2.0: globally orthotropic with material axes determined by vectors defined below, as with *DEFINE_COORDINATE_VECTOR.</p> <p>EQ.3.0: locally orthotropic material axes determined by rotating the material axes about the element normal by an angle, BETA, from a line in the plane of the element defined by the cross product of the vector <math>\mathbf{v}</math> with the element normal. The plane of a solid element is the midsurface between the inner surface and outer surface defined by the first four nodes and the last four nodes of the connectivity of the element, respectively.</p> <p>EQ.4.0: locally orthotropic in cylindrical coordinate system with the material axes determined by a vector <math>\mathbf{v}</math>, and an originating point, P, which define the centerline axis. This option is for solid elements only.</p> <p>LT.0.0: the absolute value of AOPT is a coordinate system ID number (CID on *DEFINE_COORDINATE_NODES, *DEFINE_COORDINATE_SYSTEM or *DEFINE_COORDINATE_VECTOR). Available in R3 version of 971 and later.</p>
G	Shear modulus for frequency independent damping. Frequency independent damping is based of a spring and slider in series. The critical stress for the slider mechanism is SIGF defined below. For the best results, the value of G should be 250-1000 times greater than SIGF. This option applies only to solid elements.
SIGF	Limit stress for frequency independent, frictional, damping.
XP YP ZP	Define coordinates of point $\mathbf{p}$ for AOPT = 1 and 4.
A1 A2 A3	Define components of vector $\mathbf{a}$ for AOPT = 2.
MACF	Material axes change flag for brick elements: EQ.1: No change, default, EQ.2: switch material axes a and b, EQ.3: switch material axes a and c, EQ.4: switch material axes b and c.
V1 V2 V3	Define components of vector $\mathbf{v}$ for AOPT = 3 and 4.
D1 D2 D3	Define components of vector $\mathbf{d}$ for AOPT = 2.
BETA	Material angle in degrees for AOPT = 3, may be overridden on the element card, see *ELEMENT_SHELL_BETA or *ELEMENT_SOLID_ORTHO.
REF	Use reference geometry to initialize the stress tensor. The reference

VARIABLE	DESCRIPTION
	geometry is defined by the keyword: *INITIAL_FOAM_REFERENCE_GEOMETRY (see there for more details). EQ.0.0: off, EQ.1.0: on.

**Remarks:**

The material law that relates stresses to strains is defined as:

$$\underline{C} = \underline{T}^T \underline{C}_L \underline{T}$$

where  $\underline{T}$  is a transformation matrix, and  $\underline{C}_L$  is the constitutive matrix defined in terms of the material constants of the orthogonal material axes, a, b, and c. The inverse of  $\underline{C}_L$  for the orthotropic case is defined as:

$$\underline{C}_L^{-1} = \begin{bmatrix} \frac{1}{E_a} & -\frac{\nu_{ba}}{E_b} & -\frac{\nu_{ca}}{E_c} & 0 & 0 & 0 \\ -\frac{\nu_{ab}}{E_a} & \frac{1}{E_b} & -\frac{\nu_{cb}}{E_c} & 0 & 0 & 0 \\ -\frac{\nu_{ac}}{E_a} & -\frac{\nu_{bc}}{E_b} & \frac{1}{E_c} & 0 & 0 & 0 \\ 0 & 0 & 0 & \frac{1}{G_{ab}} & 0 & 0 \\ 0 & 0 & 0 & 0 & \frac{1}{G_{bc}} & 0 \\ 0 & 0 & 0 & 0 & 0 & \frac{1}{G_{ca}} \end{bmatrix}$$

Note that  $\frac{\nu_{ab}}{E_a} = \frac{\nu_{ba}}{E_b}$ ,  $\frac{\nu_{ca}}{E_c} = \frac{\nu_{ac}}{E_a}$ ,  $\frac{\nu_{cb}}{E_c} = \frac{\nu_{bc}}{E_b}$ .

The frequency independent damping is obtained by having a spring and slider in series as shown in the following sketch:

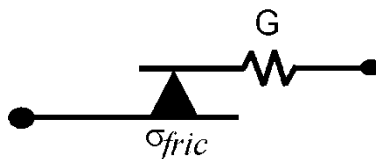

This option applies only to orthotropic solid elements and affects only the deviatoric stresses.

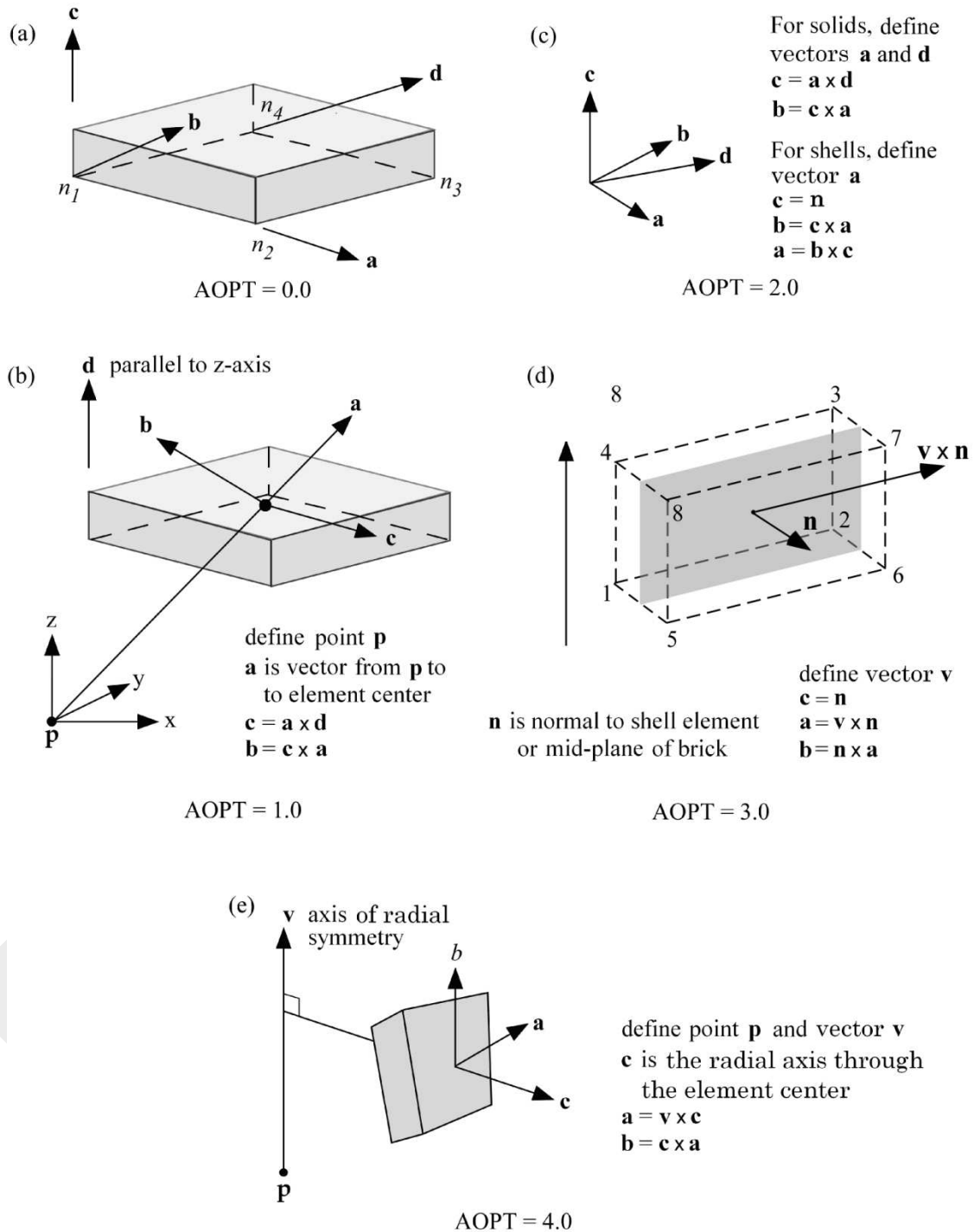

**Figure 2.1.** Options for determining principal material axes: (a) AOPT = 0.0, (b) AOPT = 1.0 for brick elements, (c) AOPT = 2.0, (d) AOPT = 3.0, and (e) AOPT=4.0 for brick elements.

The procedure for describing the principle material directions is explained for solid and shell elements for this material model and other anisotropic materials. We will call the material direction the **a-b-c** coordinate system. The AOPT options illustrated in Figure 2.1 can define the

**a-b-c** system for all elements of the parts that use the material, but this is not the final material direction. There **a-b-c** system defined by the AOPT options may be offset by a final rotation about the **c**-axis. The offset angle we call BETA.

For solid elements, the BETA angle is specified in one of two ways. When using AOPT=3, the BETA parameter defines the offset angle for all elements that use the material. The BETA parameter has no meaning for the other AOPT options. Alternatively, a BETA angle can be defined for individual solid elements as described in remark 4 for \*ELEMENT\_SOLID\_ORTHO. The beta angle by the ORTHO option is available for all values of AOPT, and it overrides the BETA angle on the \*MAT card for AOPT=3.

The directions determined by the material AOPT options may be overridden for individual elements as described in remark 2 for \*ELEMENT\_SOLID\_ORTHO. However, be aware that for materials with AOPT=3, the final **a-b-c** system will be the system defined on the element card rotated about **c**-axis by the BETA angle specified on the \*MAT card.

There are two fundamental differences between shell and solid element orthotropic materials. First, the **c**-direction is always normal to a shell element such that the **a**-direction and **b**-directions are within the plane of the element. Second, for most anisotropic materials, shell elements may have unique fiber directions within each layer through the thickness of the element so that a layered composite can be modeled with a single element.

When AOPT=0 is used in two-dimensional planar and axisymmetric analysis, it is critical that the nodes in the element definition be numbered counterclockwise for this option to work correctly.

Because shell elements have their **c**-axes defined by the element normal, AOPT=1 and AOPT=4 are not available for shells. Also, AOPT=2 requires only the vector **a** be defined since **d** is not used. The shell procedure projects the inputted **a**-direction onto each element surface.

Similar to solid elements, the **a-b-c** direction determined by AOPT is then modified by a rotation about the **c**-axis which we will call  $\phi$ . For those materials that allow a unique rotation angle for each integration point through the element thickness, the rotation angle is calculated by

$$\phi_i = \beta + \beta_i$$

where  $\beta$  is a rotation for the element, and  $\beta_i$  is the rotation for the  $i$ 'th layer of the element. The  $\beta$  angle can be input using the BETA parameter on the \*MAT data, or will be overridden for individual elements if the BETA keyword option for \*ELEMENT\_SHELL is used. The  $\beta_i$  angles are input using the ICOMP=1 option of \*SECTION\_SHELL. If  $\beta$  or  $\beta_i$  is omitted, they are assumed to be zero.

All anisotropic shell materials have the BETA option on the \*MAT card available for both AOPT=0 and AOPT=3, except for materials 91 and 92 which have it available for all values of AOPT, 0, 2, and 3.

All anisotropic shell materials allow a BETA angle for each integration point through the thickness,  $\beta_i$ , except for materials 2, 21, 86, 91, 92, 117, 130, 170, 172, and 194. This limitation however does not preclude the use of these materials for layered composites.

The most general way to model a layered composite is to use \*PART\_COMPOSITE to define a material model, thickness, and material angle,  $\beta_i$ , for each layer of a shell element. The same capability is available through the IRID option on \*SECTION\_SHELL to specify a user-defined integration rule in conjunction with the PID option on \*INTEGRATION\_SHELL. With both methods, each layer has its own material defined and can thus have its own material direction. The \*PART\_COMPOSITE method is more user-friendly and is recommended.

This discussion of material direction angles in shell elements also applies to thick shell elements which allow modeling of layered composites using \*INTEGRATION\_SHELL or \*PART\_COMPOSITE\_TSHELL.

**\*MAT\_PLASTIC\_KINEMATIC**

This is Material Type 3. This model is suited to model isotropic and kinematic hardening plasticity with the option of including rate effects. It is a very cost effective model and is available for beam (Hughes-Liu and Truss), shell, and solid elements.

Card 1            1            2            3            4            5            6            7            8

Variable	MID	RO	E	PR	SIGY	ETAN	BETA	
Type	A8	F	F	F	F	F	F	
Default	none	none	none	none	none	0.0	0.0	

Card 2            1            2            3            4            5            6            7            8

Variable	SRC	SRP	FS	VP				
Type	F	F	F	F				
Default	not used	not used	1.E+20	0.0				

<u>VARIABLE</u>	<u>DESCRIPTION</u>
MID	Material identification. A unique number or label not exceeding 8 characters must be specified.
RO	Mass density.
E	Young's modulus.
PR	Poisson's ratio.
SIGY	Yield stress.
ETAN	Tangent modulus, see Figure 3.1.
BETA	Hardening parameter, $0 < \beta' < 1$ . See comments below.
SRC	Strain rate parameter, C, for Cowper Symonds strain rate model, see below. If zero, rate effects are not considered..

<u>VARIABLE</u>	<u>DESCRIPTION</u>
SRP	Strain rate parameter, P, for Cowper Symonds strain rate model, see below. If zero, rate effects are not considered.
FS	Effective plastic strain for eroding elements.
VP	Formulation for rate effects: EQ.0.0: Scale yield stress (default), EQ.1.0: Viscoplastic formulation

**Remarks:**

Strain rate is accounted for using the Cowper and Symonds model which scales the yield stress with the factor

$$1 + \left(\frac{\dot{\epsilon}}{C}\right)^{1/p}$$

where  $\dot{\epsilon}$  is the strain rate. A fully viscoplastic formulation is optional which incorporates the Cowper and Symonds formulation within the yield surface. An additional cost is incurred but the improvement allows for dramatic results. To ignore strain rate effects set both SRC and SRP to zero.

Kinematic, isotropic, or a combination of kinematic and isotropic hardening may be specified by varying  $\beta'$  between 0 and 1. For  $\beta'$  equal to 0 and 1, respectively, kinematic and isotropic hardening are obtained as shown in Figure 3.1. For isotropic hardening,  $\beta' = 1$ , Material Model 12, \*MAT\_ISOTROPIC\_ELASTIC\_PLASTIC, requires less storage and is more efficient. Whenever possible, Material 12 is recommended for solid elements, but for shell elements it is less accurate and thus Material 12 is not recommended in this case.

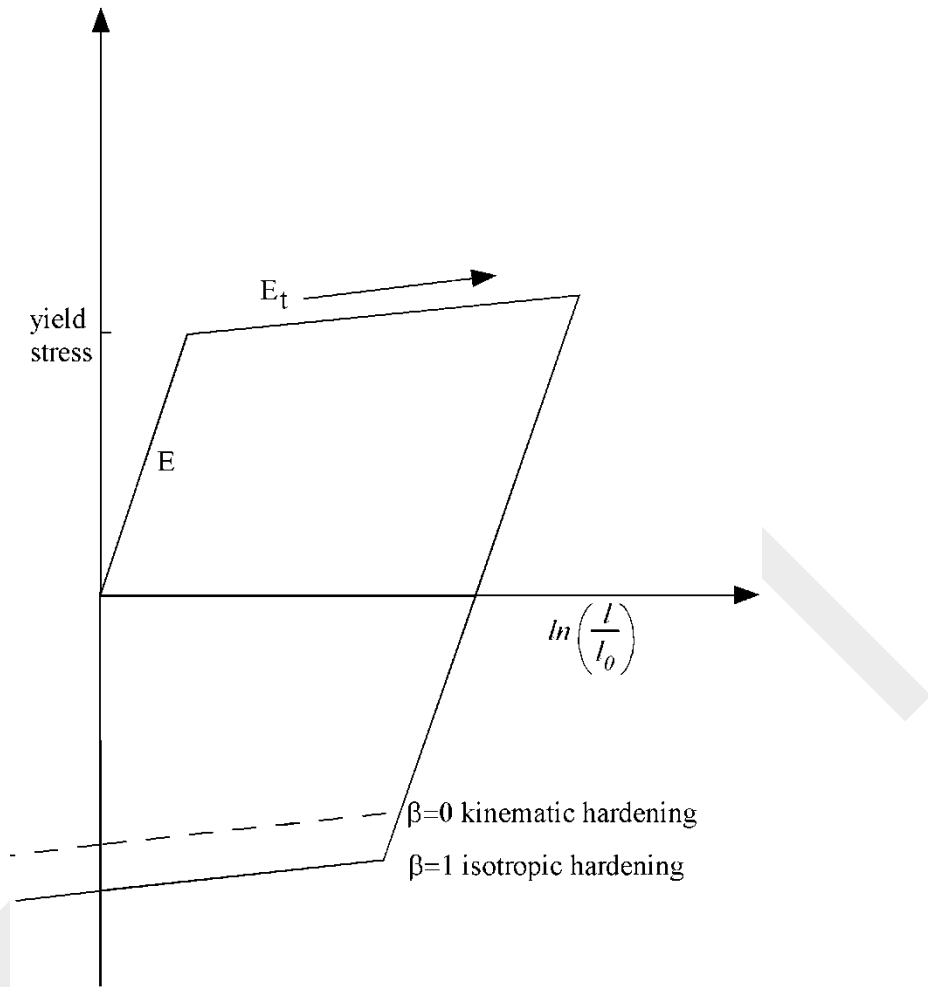

**Figure 3.1.** Elastic-plastic behavior with kinematic and isotropic hardening where  $l_0$  and  $l$  are undeformed and deformed lengths of uniaxial tension specimen.  $E_t$  is the slope of the bilinear stress strain curve.



\*MAT\_ELASTIC\_PLASTIC\_THERMAL

This is Material Type 4. Temperature dependent material coefficients can be defined. A maximum of eight temperatures with the corresponding data can be defined. A minimum of two points is needed. When this material type is used it is necessary to define nodal temperatures by activating a coupled analysis or by using another option to define the temperatures such as \*LOAD\_THERMAL\_LOAD\_CURVE, or \*LOAD\_THERMAL\_VARIABLE.

Card 1            1            2            3            4            5            6            7            8

Variable	MID	RO						
Type	A8	F						

Card 2            1            2            3            4            5            6            7            8

Variable	T1	T2	T3	T4	T5	T6	T7	T8
Type	F	F	F	F	F	F	F	F

Card 3            1            2            3            4            5            6            7            8

Variable	E1	E2	E3	E4	E5	E6	E7	E8
Type	F	F	F	F	F	F	F	F

Card 4            1            2            3            4            5            6            7            8

Variable	PR1	PR2	PR3	PR4	PR5	PR6	PR7	PR8
Type	F	F	F	F	F	F	F	F

**No defaults are assumed.**

Card 5            1            2            3            4            5            6            7            8

Variable	ALPHA1	ALPHA2	ALPHA3	ALPHA4	ALPHA5	ALPHA6	ALPHA7	ALPHA8
Type	F	F	F	F	F	F	F	F

Card 6            1            2            3            4            5            6            7            8

Variable	SIGY1	SIGY2	SIGY3	SIGY4	SIGY5	SIGY6	SIGY7	SIGY8
Type	F	F	F	F	F	F	F	F

Card 7            1            2            3            4            5            6            7            8

Variable	ETAN1	ETAN2	ETAN3	ETAN4	ETAN5	ETAN6	ETAN7	ETAN8
Type	F	F	F	F	F	F	F	F

<u>VARIABLE</u>	<u>DESCRIPTION</u>
MID	Material identification. A unique number or label not exceeding 8 characters must be specified.
RO	Mass density.
TI	Temperatures. The minimum is 2, the maximum is 8.
EI	Corresponding Young's moduli at temperature TI.
PRI	Corresponding Poisson's ratios.
ALPHA1	Corresponding coefficients of thermal expansion.
SIGY1	Corresponding yield stresses.
ETAN1	Corresponding plastic hardening moduli.

**Remarks:**

At least two temperatures and their corresponding material properties must be defined. The analysis will be terminated if a material temperature falls outside the range defined in the input. If a thermoelastic material is considered, do not define SIGY and ETAN. The coefficient of thermal expansion is defined as the instantaneous value. Thus, the thermal strain rate becomes:

$$\dot{\epsilon}_{ij}^T = \alpha \dot{T} \delta_{ij}$$

DRAFT

**\*MAT\_SOIL\_AND\_FOAM**

This is Material Type 5. This is a very simple model and works in some ways like a fluid. It should be used only in situations when soils and foams are confined within a structure or when geometric boundaries are present. A table can be defined if thermal effects are considered in the pressure versus volumetric strain behavior.

Card 1            1            2            3            4            5            6            7            8

Variable	MID	RO	G	K	A0	A1	A2	PC
Type	A8	F	F	F	F	F	F	F

Card 2            1            2            3            4            5            6            7            8

Variable	VCR	REF	LCID					
Type	F	F	F					

Card 3            1            2            3            4            5            6            7            8

Variable	EPS1	EPS2	EPS3	EPS4	EPS5	EPS6	EPS7	EPS8
Type	F	F	F	F	F	F	F	F

Card 4            1            2            3            4            5            6            7            8

Variable	EPS9	EPS10						
Type	F	F						

Card 5            1            2            3            4            5            6            7            8

Variable	P1	P2	P3	P4	P5	P6	P7	P8
Type	F	F	F	F	F	F	F	F

Card 6            1            2            3            4            5            6            7            8

Variable	P9	P10						
Type	F	F						

<u>VARIABLE</u>	<u>DESCRIPTION</u>
MID	Material identification. A unique number or label not exceeding 8 characters must be specified.
RO	Mass density.
G	Shear modulus.
K	Bulk modulus for unloading used for VCR=0.0.
A0	Yield function constant for plastic yield function below.
A1	Yield function constant for plastic yield function below.
A2	Yield function constant for plastic yield function below.
PC	Pressure cutoff for tensile fracture (< 0).
VCR	Volumetric crushing option: EQ.0.0: on, EQ.1.0: loading and unloading paths are the same.
REF	Use reference geometry to initialize the pressure. The reference geometry is defined by the keyword:*INITIAL_FOAM_REFERENCE_GEOMETRY. This option does not initialize the deviatoric stress state. EQ.0.0: off, EQ.1.0: on.

---

<u>VARIABLE</u>	<u>DESCRIPTION</u>
EPS1,.....	Volumetric strain values in pressure vs. volumetric strain curve (see Remarks below). A maximum of 10 values including 0.0 are allowed and a minimum of 2 values are necessary. If EPS1 is not 0.0 then a point (0.0,0.0) will be automatically generated and a maximum of nine values may be input.
P1, P2,..PN	Pressures corresponding to volumetric strain values given on Cards 3 and 4.
LCID	Load curve ID for pressure as a function of volumetric strain. If it is defined, then the curve is used instead of the input for EPS1..., and P1.... The response is extended to being temperature dependent if LCID refers to a table.

**Remarks:**

Pressure is positive in compression. Volumetric strain is given by the natural log of the relative volume and is negative in compression. Relative volume is a ratio of the current volume to the initial volume at the start of the calculation. The tabulated data should be given in order of increasing compression. If the pressure drops below the cutoff value specified, it is reset to that value. For a detailed description we refer to Kreig [1972].

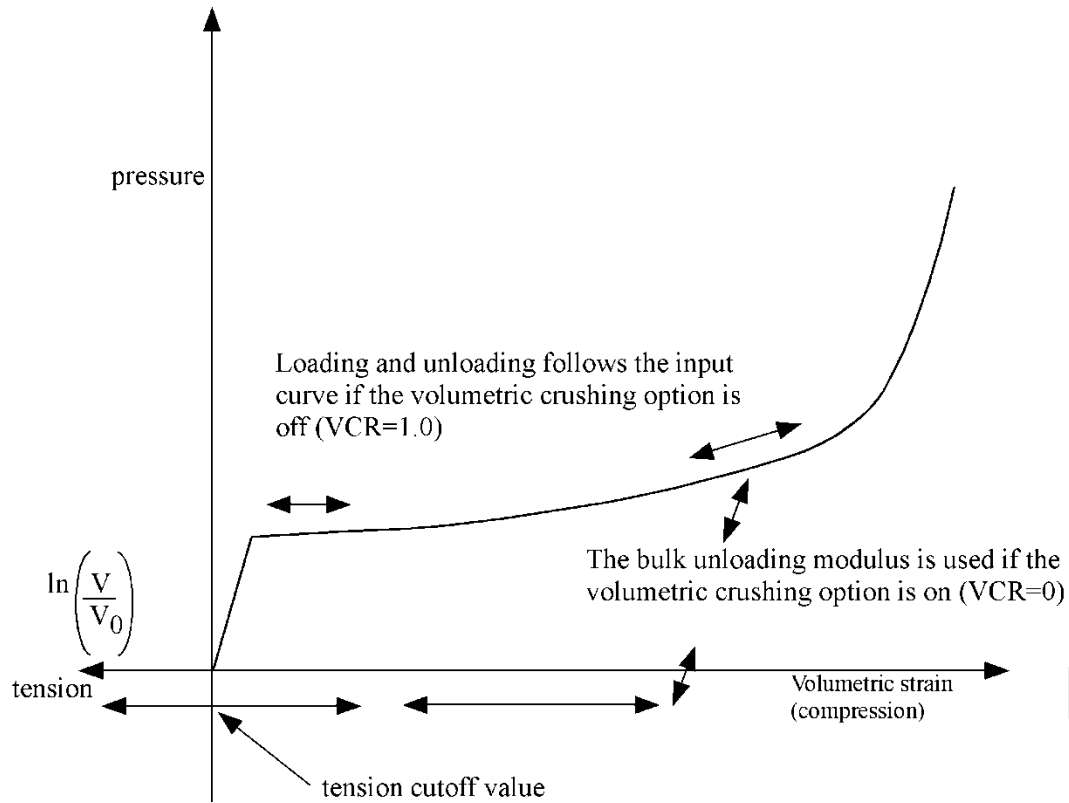

**Figure 5.1.** Pressure versus volumetric strain curve for soil and crushable foam model. The volumetric strain is given by the natural logarithm of the relative volume,  $V$ .

The deviatoric perfectly plastic yield function,  $\phi$ , is described in terms of the second invariant  $J_2$ ,

$$J_2 = \frac{1}{2} s_{ij} s_{ij},$$

pressure,  $p$ , and constants  $a_0$ ,  $a_1$ , and  $a_2$  as:

$$\phi = J_2 - [a_0 + a_1 p + a_2 p^2].$$

On the yield surface  $J_2 = \frac{1}{3} \sigma_y^2$  where  $\sigma_y$  is the uniaxial yield stress, i.e.,

$$\sigma_y = [3(a_0 + a_1 p + a_2 p^2)]^{1/2}$$

there is no strain hardening on this surface.

To eliminate the pressure dependence of the yield strength, set:

$$a_1 = a_2 = 0 \quad a_0 = \frac{1}{3} \sigma_y^2.$$

This approach is useful when a von Mises type elastic-plastic model is desired for use with the tabulated volumetric data.

The history variable labeled as “plastic strain” by LS-PrePost is actually  $\ln(V/V_0)$  in the case of \*MAT\_SOIL\_AND\_FOAM.



\*MAT\_VISCOELASTIC

This is Material Type 6. This model allows the modeling of viscoelastic behavior for beams (Hughes-Liu), shells, and solids. Also see \*MAT\_GENERAL\_VISCOELASTIC for a more general formulation.

Card 1            1            2            3            4            5            6            7            8

Variable	MID	RO	BULK	G0	GI	BETA		
Type	A8	F	F	F	F	F		

<u>VARIABLE</u>	<u>DESCRIPTION</u>
MID	Material identification. A unique number or label not exceeding 8 characters must be specified.
RO	Mass density
BULK	Elastic bulk modulus. LT.0.0:  BULK  is load curve of bulk modulus as a function of temperature.
G0	Short-time shear modulus, see equations below. LT.0.0:  G0  is load curve of short-time shear modulus as a function of temperature.
GI	Long-time (infinite) shear modulus, $G_\infty$ . LT.0.0:  GI  is load curve of long-time shear modulus as a function of temperature.
BETA	Decay constant. LT0.0:  BETA  is load curve of decay constant as a function of temperature.

**Remarks:**

The shear relaxation behavior is described by [Hermann and Peterson, 1968]:

$$G(t) = G_\infty + (G_0 - G_\infty) e^{-\beta t}$$

A Jaumann rate formulation is used

$$\overset{\nabla}{\sigma}'_{ij} = 2 \int_0^t G(t-\tau) D'_{ij}(\tau) d\tau$$

where the prime denotes the deviatoric part of the stress rate,  $\overset{\nabla}{\sigma}'_{ij}$ , and the strain rate,  $D_{ij}$ .

DRAFT

\*MAT\_BLATZ-KO\_RUBBER

This is Material Type 7. This one parameter material allows the modeling of nearly incompressible continuum rubber. The Poisson’s ratio is fixed to 0.463.

Card 1            1            2            3            4            5            6            7            8

Variable	MID	RO	G	REF				
Type	A8	F	F	F				

**VARIABLE**

**DESCRIPTION**

MID	Material identification. A unique number or label not exceeding 8 characters must be specified.
RO	Mass density.
G	Shear modulus.
REF	Use reference geometry to initialize the stress tensor. The reference geometry is defined by the keyword:*INITIAL_FOAM_REFERENCE_GEOMETRY (see there for more details). EQ.0.0: off, EQ.1.0: on.

**Remarks:**

The second Piola-Kirchhoff stress is computed as

$$S_{ij} = G \left[ \frac{1}{V} C_{ij} - V^{\left(\frac{1}{1-2\nu}\right)} \delta_{ij} \right]$$

where  $V$  is the relative volume defined as being the ratio of the current volume to the initial volume,  $C_{ij}$  is the right Cauchy-Green strain tensor, and  $\nu$  is Poisson’s ratio, which is set to .463 internally. This stress measure is transformed to the Cauchy stress,  $\sigma_{ij}$ , according to the relationship

$$\sigma_j = V^{-1} F_k F_j S_k$$

where  $F_{ij}$  is the deformation gradient tensor. Also see Blatz and Ko [1962].

**\*MAT\_HIGH\_EXPLOSIVE\_BURN**

This is Material Type 8. It allows the modeling of the detonation of a high explosive. In addition an equation of state must be defined. See Wilkins [1969] and Giroux [1973].

Card 1            1            2            3            4            5            6            7            8

Variable	MID	RO	D	PCJ	BETA	K	G	SIGY
Type	A8	F	F	F	F	F	F	F

<u>VARIABLE</u>	<u>DESCRIPTION</u>
MID	Material identification. A unique number or label not exceeding 8 characters must be specified.
RO	Mass density.
D	Detonation velocity.
PCJ	Chapman-Jouget pressure.
BETA	Beta burn flag, BETA (see comments below): EQ.0.0: beta + programmed burn, EQ.1.0: beta burn only, EQ.2.0: programmed burn only.
K	Bulk modulus (BETA=2.0 only).
G	Shear modulus (BETA=2.0 only).
SIGY	$\sigma_y$ , yield stress (BETA=2.0 only).

**Remarks:**

Burn fractions,  $F$ , which multiply the equations of states for high explosives, control the release of chemical energy for simulating detonations. At any time, the pressure in a high explosive element is given by:

$$p = Fp_{eos}(V, E)$$

where  $p_{eos}$  is the pressure from the equation of state (either types 2, 3, or 14),  $V$  is the relative volume, and  $E$  is the internal energy density per unit initial volume.

In the initialization phase, a lighting time  $t_l$  is computed for each element by dividing the distance from the detonation point to the center of the element by the detonation velocity  $D$ . If multiple detonation points are defined, the closest detonation point determines  $t_l$ . The burn fraction  $F$  is taken as the maximum

$$F = \max(F_1, F_2)$$

where

$$F_1 = \begin{cases} \frac{2(t-t_l)DA_{e_{\max}}}{3v_e} & \text{if } t > t_l \\ 0 & \text{if } t \leq t_l \end{cases}$$

$$F_2 = \beta = \frac{1-V}{1-V_{CJ}}$$

where  $V_{CJ}$  is the Chapman-Jouguet relative volume and  $t$  is current time. If  $F$  exceeds 1, it is reset to 1. This calculation of the burn fraction usually requires several time steps for  $F$  to reach unity, thereby spreading the burn front over several elements. After reaching unity,  $F$  is held constant. This burn fraction calculation is based on work by Wilkins [1964] and is also discussed by Giroux [1973].

If the beta burn option is used, BETA=1.0, any volumetric compression will cause detonation and

$$F = F_2$$

and  $F_1$  is not computed.

If programmed burn is used, BETA=2.0, the explosive model will behave as an elastic perfectly plastic material if the bulk modulus, shear modulus, and yield stress are defined. Therefore, with this option the explosive material can compress without causing detonation.

As an option, the high explosive material can behave as an elastic perfectly-plastic solid prior to detonation. In this case we update the stress tensor, to an elastic trial stress,  $*s_{ij}^{n+1}$ ,

$$*s_{ij}^{n+1} = s_{ij}^n + s_{ip} \Omega_{pj} + s_{jp} \Omega_{pi} + 2G \dot{\epsilon}'_{ij} dt$$

where  $G$  is the shear modulus, and  $\dot{\epsilon}'_{ij}$  is the deviatoric strain rate. The von Mises yield condition is given by:

$$\phi = J_2 - \frac{\sigma_y^2}{3}$$

where the second stress invariant,  $J_2$ , is defined in terms of the deviatoric stress components as

$$J_2 = \frac{1}{2} s_{ij} s_{ij}$$

and the yield stress is  $\sigma_y$ . If yielding has occurred, i.e.,  $\phi > 0$ , the deviatoric trial stress is scaled to obtain the final deviatoric stress at time n+1:

$$s_{ij}^{n+1} = \frac{\sigma_y}{\sqrt{3J_2}} * s_{ij}^{n+1}$$

If  $\phi \leq 0$ , then

$$s_{ij}^{n+1} = *s_{ij}^{n+1}$$

Before detonation pressure is given by the expression

$$p^{n+1} = K \left( \frac{1}{V^{n+1}} - 1 \right)$$

where K is the bulk modulus. Once the explosive material detonates:

$$s_{ij}^{n+1} = 0$$

and the material behaves like a gas.

**\*MAT\_NULL**

This is Material Type 9. This material allows equations of state to be considered without computing deviatoric stresses. Optionally, a viscosity can be defined. Also, erosion in tension and compression is possible.

Sometimes it is advantageous to model contact surfaces via shell elements which are not part of the structure, but are necessary to define areas of contact within nodal rigid bodies or between nodal rigid bodies.

Beams and shells that use this material type are completely bypassed in the element processing; however, the mass of the null shell elements is computed and added to the nodal points which define the connectivity. However, the mass of null beams is ignored if the value of the density is less than 1.e-11. The Young's modulus and Poisson's ratio are used only for setting the contact interface stiffness's, and it is recommended that reasonable values be input.

Card 1            1            2            3            4            5            6            7            8

Variable	MID	RO	PC	MU	TEROD	CEROD	YM	PR
Type	A8	F	F	F	F	F	F	F
Defaults	none	none	0.0	0.0	0.0	0.0	0.0	0.0

**VARIABLE****DESCRIPTION**

MID	Material identification. A unique number or label not exceeding 8 characters must be specified.
RO	Mass density
PC	Pressure cutoff ( $\leq 0.0$ ). See Remark 4.
MU	Dynamic viscosity coefficient $\mu$ (optional). See Remark 1.
TEROD	Relative volume, $\frac{V}{V_0}$ , for erosion in tension. Typically, use values greater than unity. If zero, erosion in tension is inactive.
CEROD	Relative volume, $\frac{V}{V_0}$ , for erosion in compression. Typically, use values less than unity. If zero, erosion in compression is inactive.
YM	Young's modulus (used for null beams and shells only)
PR	Poisson's ratio (used for null beams and shells only)

**Remarks:**

1. The null material must be used with an equation-of-state. Pressure cutoff is negative in tension. A (deviatoric) viscous stress of the form

$$\sigma'_{ij} = 2\mu\dot{\epsilon}'_{ij}$$

$$\left[\frac{N}{m^2}\right] \sim \left[\frac{N}{m^2}s\right] \left[\frac{1}{s}\right]$$

is computed for nonzero  $\mu$  where  $\dot{\epsilon}'_{ij}$  is the deviatoric strain rate.  $\mu$  is the dynamic viscosity. For example, in SI unit system,  $\mu$  may have a unit of [Pa\*s].

2. Null material has no shear stiffness and hourglass control must be used with great care. In some applications, the default hourglass coefficient might lead to significant energy losses. In general for fluid(s), the hourglass coefficient QM should be small (in the range 1.0E-4 to 1.0E-6 in the SI unit system for the standard default IHQ choice).
3. The Null material has no yield strength and behaves in a fluid-like manner.
4. The cut-off pressure, PC, must be defined to allow for a material to “numerically” cavitate. In other words, when a material undergoes dilatation above certain magnitude, it should no longer be able to resist this dilatation. Since dilatation stress or pressure is negative, setting PC limit to a very small negative number would allow for the material to cavitate once the pressure in the material goes below this negative value.



\*MAT\_ELASTIC\_PLASTIC\_HYDRO\_{OPTION}

This is Material Type 10. This material allows the modeling of an elastic-plastic hydrodynamic material.

Available options include:

<BLANK>

SPALL

The keyword card can appear in two ways:

\*MAT\_ELASTIC\_PLASTIC\_HYDRO or MAT\_010

\*MAT\_ELASTIC\_PLASTIC\_HYDRO\_SPALL or MAT\_010\_SPALL

Card 1            1            2            3            4            5            6            7            8

Variable	MID	RO	G	SIGY	EH	PC	FS	CHARL
Type	A8	F	F	F	F	F	F	F
Default	none	none	none	0.0	0.0	-∞	0.0	0.0

Define this card if and only if the SPALL option is specified.

Optional        1            2            3            4            5            6            7            8

Variable	A1	A2	SPALL					
Type	F	F	F					

Card 2            1            2            3            4            5            6            7            8

Variable	EPS1	EPS2	EPS3	EPS4	EPS5	EPS6	EPS7	EPS8
Type	F	F	F	F	F	F	F	F

Card 3            1            2            3            4            5            6            7            8

Variable	EPS9	EPS10	EPS11	EPS12	EPS13	EPS14	EPS15	EPS16
Type	F	F	F	F	F	F	F	F

Card 4            1            2            3            4            5            6            7            8

Variable	ES1	ES2	ES3	ES4	ES5	ES6	ES7	ES8
Type	F	F	F	F	F	F	F	F

Card 5            1            2            3            4            5            6            7            8

Variable	ES9	ES10	ES11	ES12	ES13	ES14	ES15	ES16
Type	F	F	F	F	F	F	F	F

**VARIABLE****DESCRIPTION**

MID	Material identification. A unique number or label not exceeding 8 characters must be specified.
RO	Mass density.
G	Shear modulus.
SIGY	Yield stress, see comment below.
EH	Plastic hardening modulus, see definition below.
PC	Pressure cutoff ( $\leq 0.0$ ). If zero, a cutoff of $-\infty$ is assumed.
FS	Failure strain for erosion.

VARIABLE	DESCRIPTION
CHARL	Characteristic element thickness for deletion. This applies to 2D solid elements that lie on a boundary of a part. If the boundary element thins down due to stretching or compression, and if it thins to a value less than CHARL, the element will be deleted. The primary application of this option is to predict the break-up of axisymmetric shaped charge jets.
A1	Linear pressure hardening coefficient.
A2	Quadratic pressure hardening coefficient.
SPALL	Spall type: EQ.0.0: default set to "1.0", EQ.1.0: tensile pressure is limited by PC, i.e., p is always $\geq$ PC, EQ.2.0: if $\sigma_{\max} \geq -PC$ element spalls and tension, $p < 0$ , is never allowed, EQ.3.0: $p < PC$ element spalls and tension, $p < 0$ , is never allowed.
EPS	Effective plastic strain (True). Define up to 16 values. Care must be taken that the full range of strains expected in the analysis is covered. Linear extrapolation is used if the strain values exceed the maximum input value.
ES	Effective stress. Define up to 16 values.

### **Remarks:**

If ES and EPS are undefined, the yield stress and plastic hardening modulus are taken from SIGY and EH. In this case, the bilinear stress-strain curve shown in Figure 3.1. is obtained with hardening parameter,  $\beta=1$ . The yield strength is calculated as

$$\sigma_y = \sigma_0 + E_h \bar{\epsilon}^p + (a_1 + pa_2) \max[p, 0]$$

The quantity  $E_h$  is the plastic hardening modulus defined in terms of Young's modulus,  $E$ , and the tangent modulus,  $E_t$ , as follows

$$E_h = \frac{E_t E}{E - E_t}$$

and  $p$  is the pressure taken as positive in compression.

If ES and EPS are specified, a curve like that shown in Figure 10.1. may be defined. Effective stress is defined in terms of the deviatoric stress tensor,  $s_{ij}$ , as:

$$\bar{\sigma} = \left( \frac{3}{2} s_{ij} s_{ij} \right)^{1/2}$$

and effective plastic strain by:

$$\bar{\varepsilon}^p = \int_0^t \left( \frac{2}{3} D_{ij}^p D_{ij}^p \right)^{1/2} dt,$$

where  $t$  denotes time and  $D_{ij}^p$  is the plastic component of the rate of deformation tensor. In this case the plastic hardening modulus on Card 1 is ignored and the yield stress is given as

$$\sigma_y = f(\bar{\varepsilon}^p),$$

where the value for  $f(\bar{\varepsilon}^p)$  is found by interpolation from the data curve.

A choice of three spall models is offered to represent material splitting, cracking, and failure under tensile loads. The pressure limit model, SPALL=1, limits the hydrostatic tension to the specified value,  $p_{cut}$ . If pressures more tensile than this limit are calculated, the pressure is reset to  $p_{cut}$ . This option is not strictly a spall model, since the deviatoric stresses are unaffected by the pressure reaching the tensile cutoff, and the pressure cutoff value,  $p_{cut}$ , remains unchanged throughout the analysis. The maximum principal stress spall model, SPALL=2, detects spall if the maximum principal stress,  $\sigma_{max}$ , exceeds the limiting value  $-p_{cut}$ . Note that the negative sign is required because  $p_{cut}$  is measured positive in compression, while  $\sigma_{max}$  is positive in tension. Once spall is detected with this model, the deviatoric stresses are reset to zero, and no hydrostatic tension ( $p < 0$ ) is permitted. If tensile pressures are calculated, they are reset to 0 in the spalled material. Thus, the spalled material behaves as a rubble or incohesive material. The hydrostatic tension spall model, SPALL=3, detects spall if the pressure becomes more tensile than the specified limit,  $p_{cut}$ . Once spall is detected the deviatoric stresses are reset to zero, and nonzero values of pressure are required to be compressive (positive). If hydrostatic tension ( $p < 0$ ) is subsequently calculated, the pressure is reset to 0 for that element.

This model is applicable to a wide range of materials, including those with pressure-dependent yield behavior. The use of 16 points in the yield stress versus effective plastic strain curve allows complex post-yield hardening behavior to be accurately represented. In addition, the incorporation of an equation of state permits accurate modeling of a variety of different materials. The spall model options permit incorporation of material failure, fracture, and disintegration effects under tensile loads.

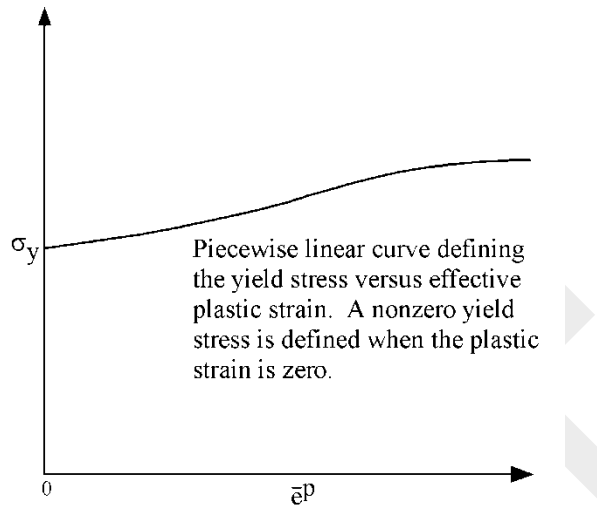

Figure 10.1. Effective stress versus effective plastic strain curve.

**\*MAT\_STEINBERG**

This is Material Type 11. This material is available for modeling materials deforming at very high strain rates ( $>10^5$ ) and can be used with solid elements. The yield strength is a function of temperature and pressure. An equation of state determines the pressure.

Card 1            1            2            3            4            5            6            7            8

Variable	MID	RO	G0	SIGO	BETA	N	GAMA	SIGM
Type	A8	F	F	F	F	F	F	F

Card 2            1            2            3            4            5            6            7            8

Variable	B	BP	H	F	A	TMO	GAMO	SA
Type	F	F	F	F	F	F	F	F

Card 3            1            2            3            4            5            6            7            8

Variable	PC	SPALL	RP	FLAG	MMN	MMX	ECO	EC1
Type	F	F	F	F	F	F	F	F

Card 4            1            2            3            4            5            6            7            8

Variable	EC2	EC3	EC4	EC5	EC6	EC7	EC8	EC9
Type	F	F	F	F	F	F	F	F

<u>VARIABLE</u>	<u>DESCRIPTION</u>
MID	Material identification. A unique number or label not exceeding 8 characters must be specified.
RO	Mass density.

VARIABLE	DESCRIPTION
G0	Basic shear modulus.
SIGO	$\sigma_0$ , see defining equations.
BETA	$\beta$ , see defining equations.
N	n, see defining equations.
GAMA	$\gamma_i$ , initial plastic strain, see defining equations.
SIGM	$\sigma_m$ , see defining equations.
B	b, see defining equations.
BP	b', see defining equations.
H	h, see defining equations.
F	f, see defining equations.
A	Atomic weight (if = 0.0, R' must be defined).
TMO	$T_{mo}$ , see defining equations.
GAMO	$\gamma_0$ , see defining equations.
SA	a, see defining equations.
PC	Pressure cutoff (default=-1.e+30)
SPALL	Spall type: EQ. 0.0: default set to "2.0", EQ. 1.0: $p \geq PC$ , EQ. 2.0: if $\sigma_{max} \geq -PC$ element spalls and tension, $p < 0$ , is never allowed, EQ. 3.0: $p < PC$ element spalls and tension, $p < 0$ , is never allowed.
RP	R'. If $R' \neq 0.0$ , A is not defined.
FLAG	Set to 1.0 for $\mu$ coefficients for the cold compression energy fit. Default is $\eta$ .
MMN	$\mu_{min}$ or $\eta_{min}$ . Optional $\mu$ or $\eta$ minimum value.
MMX	$\mu_{max}$ or $\eta_{max}$ . Optional $\mu$ or $\eta$ maximum value.

VARIABLE	DESCRIPTION
EC0,...EC9	Cold compression energy coefficients (optional).

**Remarks:**

Users who have an interest in this model are encouraged to study the paper by Steinberg and Guinan which provides the theoretical basis. Another useful reference is the KOVEC user’s manual.

In terms of the foregoing input parameters, we define the shear modulus, G, before the material melts as:

$$G = G_0 \left[ 1 + bpV^{1/3} - h \left( \frac{E_i - E_c}{3R'} - 300 \right) \right] e^{-E_i/E_m - E_i}$$

where p is the pressure, V is the relative volume, E<sub>c</sub> is the cold compression energy:

$$E_c(x) = \int_0^x p dx - \frac{900 R' \exp(ax)}{(1-x)^{2(\gamma_0 - a - 1/2)}}$$

$$x = 1 - V,$$

and E<sub>m</sub> is the melting energy:

$$E_m(x) = E_c(x) + 3R'T_m(x)$$

which is in terms of the melting temperature T<sub>m</sub>(x):

$$T_m(x) = \frac{T_{m0} \exp(2ax)}{V^{2(\gamma_0 - a - 1/2)}}$$

and the melting temperature at ρ = ρ<sub>0</sub>, T<sub>m0</sub>.

In the above equation R' is defined by

$$R' = \frac{R\rho}{A}$$

where R is the gas constant and A is the atomic weight. If R' is not defined, LS-DYNA computes it with R in the cm-gram-microsecond system of units.

The yield strength σ<sub>y</sub> is given by:



$$\sigma_y = \sigma'_0 \left[ 1 + b'pV^{1/3} - h \left( \frac{E_i - E_c}{3R'} - 300 \right) \right] e^{-E_i/E_m - E_i}$$

if  $E_m$  exceeds  $E_i$ . Here,  $\sigma'_0$  is given by:

$$\sigma'_0 = \sigma_0 \left[ 1 + \beta(\gamma_i + \bar{\epsilon}^p) \right]^n$$

where  $\sigma_0$  is the initial yield stress and  $\gamma_i$  is the initial plastic strain. If the work-hardened yield stress  $\sigma'_0$  exceeds  $\sigma_m$ ,  $\sigma'_0$  is set equal to  $\sigma_m$ . After the materials melt,  $\sigma_y$  and  $G$  are set to one half their initial value.

If the coefficients  $EC_0, \dots, EC_9$  are not defined above, LS-DYNA will fit the cold compression energy to a ten term polynomial expansion either as a function of  $\mu$  or  $\eta$  depending on the input variable, FLAG, as:

$$E_c(\eta^i) = \sum_{i=0}^9 EC_i \eta^i$$

$$E_c(\mu^i) = \sum_{i=0}^9 EC_i \mu^i$$

where  $EC_i$  is the  $i$ th coefficient and:

$$\eta = \frac{\rho}{\rho_o}$$

$$\mu = \frac{\rho}{\rho_o} - 1$$

A linear least squares method is used to perform the fit.

A choice of three spall models is offered to represent material splitting, cracking, and failure under tensile loads. The pressure limit model, SPALL=1, limits the hydrostatic tension to the specified value,  $p_{cut}$ . If pressures more tensile than this limit are calculated, the pressure is reset to  $p_{cut}$ . This option is not strictly a spall model, since the deviatoric stresses are unaffected by the pressure reaching the tensile cutoff, and the pressure cutoff value,  $p_{cut}$ , remains unchanged throughout the analysis. The maximum principal stress spall model, SPALL=2, detects spall if the maximum principal stress,  $\sigma_{max}$ , exceeds the limiting value  $-p_{cut}$ . Note that the negative sign is required because  $p_{cut}$  is measured positive in compression, while  $\sigma_{max}$  is positive in tension. Once spall is detected with this model, the deviatoric stresses are reset to zero, and no hydrostatic tension ( $p < 0$ ) is permitted. If tensile pressures are calculated, they are reset to 0 in the spalled material. Thus, the spalled material behaves as a rubble or incohesive material. The hydrostatic tension spall model, SPALL=3, detects spall if the pressure becomes more tensile than the specified limit,  $p_{cut}$ . Once spall is detected the deviatoric stresses are reset to zero, and nonzero

values of pressure are required to be compressive (positive). If hydrostatic tension ( $p < 0$ ) is subsequently calculated, the pressure is reset to 0 for that element.

This model is applicable to a wide range of materials, including those with pressure-dependent yield behavior. In addition, the incorporation of an equation of state permits accurate modeling of a variety of different materials. The spall model options permit incorporation of material failure, fracture, and disintegration effects under tensile loads.

**\*MAT\_STEINBERG\_LUND**

This is Material Type 11. This material is a modification of the Steinberg model above to include the rate model of Steinberg and Lund [1989]. An equation of state determines the pressure.

The keyword cards can appear in two ways:

**\*MAT\_STEINBERG\_LUND or MAT\_011\_LUND**

Card 1            1            2            3            4            5            6            7            8

Variable	MID	RO	G0	SIGO	BETA	N	GAMA	SIGM
Type	A8	F	F	F	F	F	F	F

Card 2            1            2            3            4            5            6            7            8

Variable	B	BP	H	F	A	TMO	GAMO	SA
Type	F	F	F	F	F	F	F	F

Card 3            1            2            3            4            5            6            7            8

Variable	PC	SPALL	RP	FLAG	MMN	MMX	ECO	EC1
Type	F	F	F	F	F	F	F	F

Card 4            1            2            3            4            5            6            7            8

Variable	EC2	EC3	EC4	EC5	EC6	EC7	EC8	EC9
Type	F	F	F	F	F	F	F	F

Card 5            1            2            3            4            5            6            7            8

Variable	UK	C1	C2	YP	YA	YM		
Type	F	F	F	F	F	F		

<u>VARIABLE</u>	<u>DESCRIPTION</u>
MID	Material identification. A unique number or label not exceeding 8 characters must be specified.
RO	Mass density.
G0	Basic shear modulus.
SIGO	$\sigma_0$ , see defining equations.
BETA	$\beta$ , see defining equations.
N	n, see defining equations.
GAMA	$\gamma_i$ , initial plastic strain, see defining equations.
SIGM	$\sigma_m$ , see defining equations.
B	b, see defining equations.
BP	b', see defining equations.
H	h, see defining equations.
F	f, see defining equations.
A	Atomic weight (if = 0.0, R' must be defined).
TMO	$T_{mo}$ , see defining equations.
GAMO	$\gamma_0$ , see defining equations.
SA	a, see defining equations.
PC	$p_{cut}$ or $-\sigma_f$ (default=-1.e+30)

VARIABLE	DESCRIPTION
SPALL	Spall type: EQ. 0.0: default set to "2.0", EQ. 1.0: $p \geq p_{\min}$ , EQ. 2.0: if $\sigma_{\max} \geq -p_{\min}$ element spalls and tension, $p < 0$ , is never allowed, EQ. 3.0: $p < -p_{\min}$ element spalls and tension, $p < 0$ , is never allowed.
RP	R'. If $R' \neq 0.0$ , A is not defined.
FLAG	Set to 1.0 for $\mu$ coefficients for the cold compression energy fit. Default is $\eta$ .
MMN	$\mu_{\min}$ or $\eta_{\min}$ . Optional $\mu$ or $\eta$ minimum value.
MMX	$\mu_{\max}$ or $\eta_{\max}$ . Optional $\mu$ or $\eta$ maximum value.
EC0,...EC9	Cold compression energy coefficients (optional).
UK	Activation energy for rate dependent model.
C1	Exponent prefactor in rate dependent model.
C2	Coefficient of drag term in rate dependent model.
YP	Peierls stress for rate dependent model.
YA	A thermal yield stress for rate dependent model.
YMAX	Work hardening maximum for rate model.

**Remarks:**

This model is similar in theory to the \*MAT\_STEINBERG above but with the addition of rate effects. When rate effects are included, the yield stress is given by:

$$\sigma_y = \left\{ Y_T(\dot{\epsilon}_p, T) + Y_A f(\epsilon_p) \right\} \frac{G(p, T)}{G_0}$$

There are two imposed limits on the yield stress. The first is on the thermal yield stress:

$$Y_A f(\epsilon_p) = Y_A \left[ 1 + \beta(\gamma_i + \epsilon^p) \right]^n \leq Y_{\max}$$

and the second is on the thermal part:

$$Y_T \leq Y_P$$

DRAFT

\*MAT\_ISOTROPIC\_ELASTIC\_PLASTIC

This is Material Type 12. This is a very low cost isotropic plasticity model for three-dimensional solids. In the plane stress implementation for shell elements, a one-step radial return approach is used to scale the Cauchy stress tensor to if the state of stress exceeds the yield surface. This approach to plasticity leads to inaccurate shell thickness updates and stresses after yielding. This is the only model in LS-DYNA for plane stress that does not default to an iterative approach.

Card            1            2            3            4            5            6            7            8

Variable	MID	RO	G	SIGY	ETAN	BULK		
Type	A8	F	F	F	F	F		

**VARIABLE**

**DESCRIPTION**

MID	Material identification. A unique number or label not exceeding 8 characters must be specified.
RO	Mass density.
G	Shear modulus.
SIGY	Yield stress.
ETAN	Plastic hardening modulus.
BULK	Bulk modulus, K.

**Remarks:**

Here the pressure is integrated in time

$$\dot{p} = -K \dot{\epsilon}_{ii}$$

where  $\dot{\epsilon}_{ii}$  is the volumetric strain rate.

**\*MAT\_ISOTROPIC\_ELASTIC\_FAILURE**

This is Material Type 13. This is a non-iterative plasticity with simple plastic strain failure model.

Card 1            1            2            3            4            5            6            7            8

Variable	MID	RO	G	SIGY	ETAN	BULK		
Type	A8	F	F	F	F	F		
Default	None	none	none	none	0.0	none		

Card 2            1            2            3            4            5            6            7            8

Variable	EPF	PRF	REM	TREM				
Type	F	F	F	F				
Default	None	0.0	0.0	0.0				

**VARIABLE****DESCRIPTION**

MID	Material identification. A unique number or label not exceeding 8 characters must be specified.
RO	Mass density.
G	Shear modulus.
SIGY	Yield stress.
ETAN	Plastic hardening modulus.
BULK	Bulk modulus.
EPF	Plastic failure strain.
PRF	Failure pressure ( $\leq 0.0$ ).



---

<u>VARIABLE</u>	<u>DESCRIPTION</u>
REM	Element erosion option: EQ.0.0: failed element eroded after failure, NE.0.0: element is kept, no removal except by $\Delta t$ below.
TREM	$\Delta t$ for element removal: EQ.0.0: $\Delta t$ is not considered (default), GT.0.0: element eroded if element time step size falls below $\Delta t$ .

**Remarks:**

When the effective plastic strain reaches the failure strain or when the pressure reaches the failure pressure, the element loses its ability to carry tension and the deviatoric stresses are set to zero, i.e., the material behaves like a fluid. If  $\Delta t$  for element removal is defined the element removal option is ignored.

The element erosion option based on  $\Delta t$  must be used cautiously with the contact options. Nodes to surface contact is recommended with all nodes of the eroded brick elements included in the node list. As the elements are eroded the mass remains and continues to interact with the master surface.

**\*MAT\_SOIL\_AND\_FOAM\_FAILURE**

This is Material Type 14. The input for this model is the same as for \*MATERIAL\_SOIL\_AND\_FOAM (Type 5); however, when the pressure reaches the failure pressure, the element loses its ability to carry tension. It should be used only in situations when soils and foams are confined within a structure or when geometric boundaries are present.

**\*MAT\_JOHNSON\_COOK**

This is Material Type 15. The Johnson/Cook strain and temperature sensitive plasticity is sometimes used for problems where the strain rates vary over a large range and adiabatic temperature increases due to plastic heating cause material softening. When used with solid elements this model requires an equation-of-state. If thermal effects and damage are unimportant, the much less expensive \*MAT\_SIMPLIFIED\_JOHNSON\_COOK model is recommended. The simplified model can be used with beam elements.

Card 1            1            2            3            4            5            6            7            8

Variable	MID	RO	G	E	PR	DTF	VP	RATEOP
Type	A8	F	F	F	F	F	F	F
Default	none	none	none	none	none	0.0	0.0	0.0

Card 2            1            2            3            4            5            6            7            8

Variable	A	B	N	C	M	TM	TR	EPS0
Type	F	F	F	F	F	F	F	F
Default	none	0.0	0.0	0.0	none	none	none	none

Card 3            1            2            3            4            5            6            7            8

Variable	CP	PC	SPALL	IT	D1	D2	D3	D4
Type	F	F	F	F	F	F	F	F
Default	none	0.0	2.0	0.0	0.0	0.0	0.0	0.0

Card 4            1            2            3            4            5            6            7            8

Variable	D5	C2/P	EROD	EFMIN	NUMINT			
Type	F	F	F	F	F			
Default	0.0	0.0	0.0	0.000001	0.			

<u>VARIABLE</u>	<u>DESCRIPTION</u>
MID	Material identification. A unique number or label not exceeding 8 characters must be specified.
RO	Mass density
G	Shear modulus
E	Young's Modulus (shell elements only)
PR	Poisson's ratio (shell elements only)
DTF	Minimum time step size for automatic element deletion (shell elements). The element will be deleted when the solution time step size drops below DTF*TSSFAC where TSSFAC is the time step scale factor defined by *CONTROL_TIMESTEP.
VP	Formulation for rate effects: EQ.0.0: Scale yield stress (default), EQ.1.0: Viscoplastic formulation.
RATEOP	Optional forms of strain-rate term: EQ.0.0: Log-Linear Johnson-Cook (default), EQ.1.0: Log-Quadratic Huh-Kang (2 parameters), EQ.2.0: Exponential Allen-Rule-Jones, EQ.3.0: Exponential Cowper-Symonds (2 parameters).
A	See equations below.
B	See equations below.
N	See equations below.
C	See equations below.
M	See equations below.

VARIABLE	DESCRIPTION
TM	Melt temperature
TR	Room temperature
EPSO	Quasi-static threshold strain rate. Ideally, this value represents the highest strain rate for which no rate adjustment to the flow stress is needed, and is input in units of 1/model time units. For example, if strain rate effects on the flow stress first become apparent at strain rates greater than 1E-02 seconds <sup>-1</sup> and the system of units for the model input is kg, mm, msec, then EPSO should be set to 1E-05 [msec <sup>-1</sup> ]
CP	Specific heat (superseded by heat capacity in *MAT_THERMAL_OPTION if a coupled thermal/structural analysis)
PC	Failure stress or pressure cutoff (PC < 0.0)
SPALL	Spall type: EQ.0.0: default set to "2.0", EQ.1.0: Tensile pressure is limited by PC, i.e., p is always ≥ PC, EQ.2.0: $\sigma_{\max} \geq -PC$ triggers shell element deletion and tensile stresses to be reset to zero in solid elements. Only compressive stresses are subsequently allowed in solids, EQ.3.0: p < PC triggers shell element deletion and pressure to be reset to zero in solid elements. Tensile pressure is subsequently disallowed in solids.
IT	Plastic strain iteration option. This input applies to solid elements with VP=0.0 only since it is always necessary to iterate for the shell element plane stress condition and for VP=1.0. EQ.0.0: no iterations (default), EQ.1.0: accurate iterative solution for plastic strain. Much more expensive than default.
D1-D5	Failure parameters, see equations below.
C2/P	Optional strain-rate parameter for Huh-Kang (C2) or Cowper-Symonds (P) forms; see equations below.
EROD	Erosion flag: EQ.0.0: default, element erosion allowed. NE.0.0: element does not erode; deviatoric stresses set to zero when element fails.
EFMIN	Lower bound for strain at fracture.

VARIABLE	DESCRIPTION
NUMINT	Number of through thickness integration points which must fail before the shell element is deleted. (If zero, all points must fail.) The default of all integration points is not recommended since elements undergoing large strain are often not deleted due to nodal fiber rotations which limit strains at active integration points after most points have failed. Better results are obtained if NUMINT is set to 1 or a number less than one half of the number of through thickness points. For example, if four through thickness points are used, NUMINT should not exceed 2, even for fully integrated shells which have 16 integration points.

**Remarks:**

Johnson and Cook express the flow stress as

$$\sigma_y = \left( A + B\bar{\epsilon}^n \right) \left( 1 + c \ln \dot{\epsilon}^* \right) \left( 1 - T^{*m} \right)$$

where

A, B, C, n, and m = input constants

$\bar{\epsilon}^p$  effective plastic strain

For VP=0,  $\dot{\epsilon}^* = \frac{\dot{\epsilon}}{EPS0}$  effective total strain rate normalized by quasi-static threshold rate

For VP=1,  $\dot{\epsilon}^* = \frac{\dot{\epsilon}^p}{EPS0}$  effective plastic strain rate normalized by quasi-static threshold rate

$$T^* = \text{homologous temperature} = \frac{T - T_{room}}{T_{melt} - T_{room}}$$

The quantity  $T - T_{room}$  is stored as extra history variable 5.

Constants for a variety of materials are provided in Johnson and Cook [1983]. A fully viscoplastic formulation is optional (VP) which incorporates the rate equations within the yield surface. An additional cost is incurred but the improvement is that results can be dramatic.

Due to nonlinearity in the dependence of flow stress on plastic strain, an accurate value of the flow stress requires iteration for the increment in plastic strain. However, by using a Taylor series expansion with linearization about the current time, we can solve for  $\sigma_y$  with sufficient accuracy to avoid iteration.

The strain at fracture is given by

$$\varepsilon^f = \left( \left[ D_1 + D_2 \exp D_3 \sigma^* \right] \left[ 1 + D_4 \ln \dot{\varepsilon}^* \right] \left[ 1 + D_5 T^* \right], EFMIN \right)$$

where  $\sigma^*$  is the ratio of pressure divided by effective stress

$$\sigma^* = \frac{p}{\sigma_{eff}}$$

Fracture occurs when the damage parameter

$$D = \sum \frac{\Delta \bar{\varepsilon}^p}{\varepsilon^f}$$

reaches the value of 1.  $D$  is stored as extra history variable 4 in shell elements and extra history variable 6 in solid elements.

A choice of three spall models is offered to represent material splitting, cracking, and failure under tensile loads. The pressure limit model limits the minimum hydrostatic pressure to the specified value,  $p \geq p_{min}$ . If pressures more tensile than this limit are calculated, the pressure is reset to  $p_{min}$ . This option is not strictly a spall model since the deviatoric stresses are unaffected by the pressure reaching the tensile cutoff and the pressure cutoff value  $p_{min}$  remains unchanged throughout the analysis. The maximum principal stress spall model detects spall if the maximum principal stress,  $\sigma_{max}$ , exceeds the limiting value  $\sigma_p$ . Once spall in solids is detected with this model, the deviatoric stresses are reset to zero and no hydrostatic tension is permitted. If tensile pressures are calculated, they are reset to 0 in the spalled material. Thus, the spalled material behaves as rubble. The hydrostatic tension spall model detects spall if the pressure becomes more tensile than the specified limit,  $p_{min}$ . Once spall in solids is detected with this model, the deviatoric stresses are set to zero and the pressure is required to be compressive. If hydrostatic tension is calculated then the pressure is reset to 0 for that element.

In addition to the above failure criterion, this material model also supports a shell element deletion criterion based on the maximum stable time step size for the element,  $\Delta t_{max}$ . Generally,  $\Delta t_{max}$  goes down as the element becomes more distorted. To assure stability of time integration, the global LS-DYNA time step is the minimum of the  $\Delta t_{max}$  values calculated for all elements in the model. Using this option allows the selective deletion of elements whose time step  $\Delta t_{max}$  has fallen below the specified minimum time step,  $\Delta t_{crit}$ . Elements which are severely distorted often indicate that material has failed and supports little load, but these same elements may have very small time steps and therefore control the cost of the analysis. This option allows these highly distorted elements to be deleted from the calculation, and, therefore, the analysis can proceed at a larger time step, and, thus, at a reduced cost. Deleted elements do not carry any load, and are deleted from all applicable slide surface definitions. Clearly, this option must be judiciously used to obtain accurate results at a minimum cost.

Material type 15 is applicable to the high rate deformation of many materials including most metals. Unlike the Steinberg-Guinan model, the Johnson-Cook model remains valid down to lower strain rates and even into the quasistatic regime. Typical applications include explosive metal forming, ballistic penetration, and impact.

Optional Strain Rate Forms

The standard Johnson-Cook strain rate term is linear in the logarithm of the strain rate:

$$1 + C \ln \dot{\epsilon}^*$$

Some additional data fitting capability can be obtained by using the quadratic form proposed by Huh & Kang [2002]:

$$1 + C \ln \dot{\epsilon}^* + C_2 (\ln \dot{\epsilon}^*)^2$$

Two additional exponential forms are available, one due to Allen, Rule & Jones [1997]

$$(\dot{\epsilon}^*)^c$$

and the other a Cowper-Symonds-like [1958] form:

$$1 + \left( \frac{\dot{\epsilon}_{eff}^p}{C} \right)^{\frac{1}{P}}$$

The three additional rate forms (RATEOP=1,2, or 3) are currently available for solid & shell elements but only when the viscoplastic rate option is active (VP=1). See Huh and Kang [2002], Allen, Rule, and Jones [1997], and Cowper and Symonds [1958].



**\*MAT\_PSEUDO\_TENSOR**

This is Material Type 16. This model has been used to analyze buried steel reinforced concrete structures subjected to impulsive loadings.

Card 1            1            2            3            4            5            6            7            8

Variable	MID	RO	G	PR				
Type	A8	F	F	F				
Default	none	none	none	none				

Card 2            1            2            3            4            5            6            7            8

Variable	SIGF	A0	A1	A2	A0F	A1F	B1	PER
Type	F	F	F	F	F	F	F	F
Default	0.0	0.0	0.0	0.0	0.0	0.0	0.0	0.0

Card 3            1            2            3            4            5            6            7            8

Variable	ER	PRR	SIGY	ETAN	LCP	LCR		
Type	F	F	F	F	F	F		
Default	0.0	0.0	none	0.0	none	none		

Card 4            1            2            3            4            5            6            7            8

Variable	X1	X2	X3	X4	X5	X6	X7	X8
Type	F	F	F	F	F	F	F	F
Default	none	none	none	none	none	none	none	none

Card 5            1            2            3            4            5            6            7            8

Variable	X9	X10	X11	X12	X13	X14	X15	X16
Type	F	F	F	F	F	F	F	F
Default	none	none	none	none	none	none	none	none

Card 6            1            2            3            4            5            6            7            8

Variable	YS1	YS2	YS3	YS4	YS5	YS6	YS7	YS8
Type	F	F	F	F	F	F	F	F
Default	none	none	none	none	none	none	none	none

Card 7            1            2            3            4            5            6            7            8

Variable	YS9	YS10	YS11	YS12	YS13	YS14	YS15	YS16
Type	F	F	F	F	F	F	F	F
Default	none	none	none	none	none	none	none	none

<u>VARIABLE</u>	<u>DESCRIPTION</u>
MID	Material identification. A unique number or label not exceeding 8 characters must be specified.
RO	Mass density.
G	Shear modulus.
PR	Poisson's ratio.
SIGF	Tensile cutoff (maximum principal stress for failure).
A0	Cohesion.
A1	Pressure hardening coefficient.
A2	Pressure hardening coefficient.
A0F	Cohesion for failed material.
A1F	Pressure hardening coefficient for failed material.
B1	Damage scaling factor (or exponent in Mode II.C).
PER	Percent reinforcement.
ER	Elastic modulus for reinforcement.
PRR	Poisson's ratio for reinforcement.
SIGY	Initial yield stress.
ETAN	Tangent modulus/plastic hardening modulus.
LCP	Load curve ID giving rate sensitivity for principal material, see *DEFINE_CURVE.
LCR	Load curve ID giving rate sensitivity for reinforcement, see *DEFINE_CURVE.
$X_n$	Effective plastic strain, damage, or pressure. See discussion below.
$YS_n$	Yield stress (Mode I) or scale factor (Mode II.B or II.C).

**Remarks:**

This model can be used in two major modes - a simple tabular pressure-dependent yield surface, and a potentially complex model featuring two yield versus pressure functions with the means of

migrating from one curve to the other. For both modes, load curve LCP is taken to be a strain rate multiplier for the yield strength. Note that this model must be used with equation-of-state type 8 or 9.

**Response Mode I. Tabulated Yield Stress Versus Pressure**

This model is well suited for implementing standard geologic models like the Mohr-Coulomb yield surface with a Tresca limit, as shown in Figure 16.1. Examples of converting conventional triaxial compression data to this type of model are found in (Desai and Siriwardane, 1984). Note that under conventional triaxial compression conditions, the LS-DYNA input corresponds to an ordinate of  $\sigma_1 - \sigma_3$  rather than the more widely used  $\frac{\sigma_1 - \sigma_3}{2}$ , where  $\sigma_1$  is the maximum principal stress and  $\sigma_3$  is the minimum principal stress.

This material combined with equation-of-state type 9 (saturated) has been used very successfully to model ground shocks and soil-structure interactions at pressures up to 100kbars (approximately  $1.5 \times 10^6$  psi).

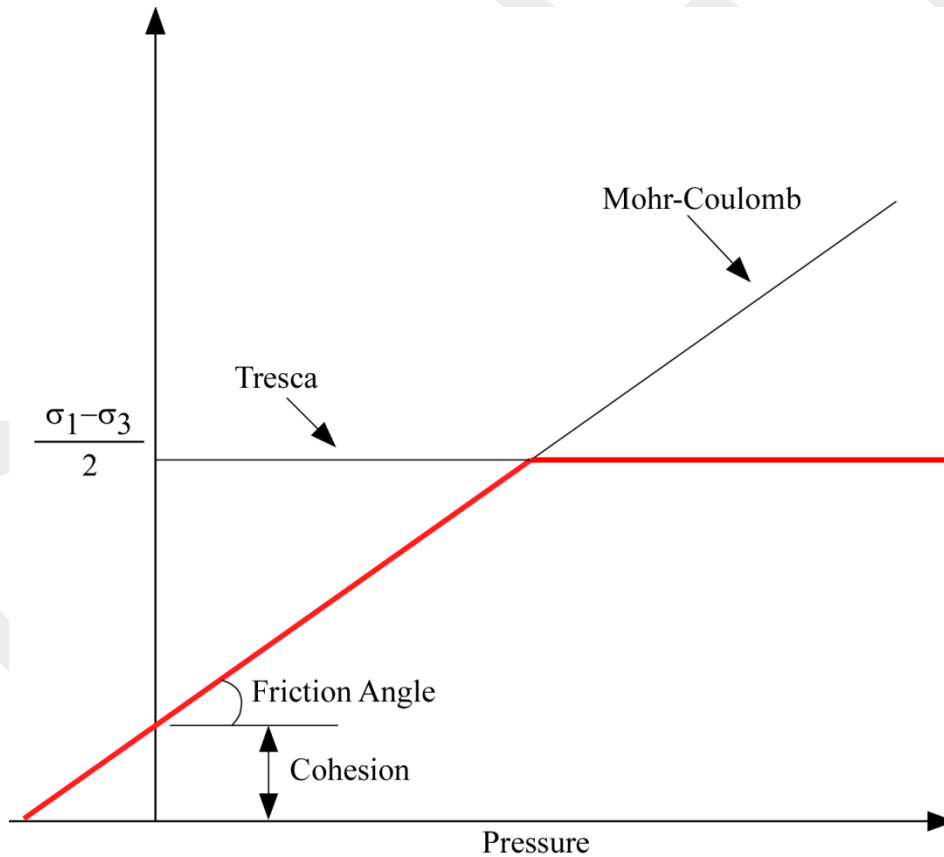

**Figure 16.1.** Mohr-Coulomb surface with a Tresca limit.

To invoke Mode I of this model, set  $a_0$ ,  $a_1$ ,  $a_2$ ,  $b_1$ ,  $a_{0f}$ , and  $a_{1f}$  to zero. The tabulated values of pressure should then be specified on cards 4 and 5, and the corresponding values of yield stress should be specified on cards 6 and 7. The parameters relating to reinforcement properties, initial yield stress, and tangent modulus are not used in this response mode, and should be set to zero.

### Simple tensile failure

Note that  $a_{1f}$  is reset internally to 1/3 even though it is input as zero; this defines a failed material curve of slope  $3p$ , where  $p$  denotes pressure (positive in compression). In this case the yield strength is taken from the tabulated yield vs. pressure curve until the maximum principal stress ( $\sigma_1$ ) in the element exceeds the tensile cut-off ( $\sigma_{cut}$ ). For every time step that  $\sigma_1 > \sigma_{cut}$  the yield strength is scaled back by a fraction of the distance between the two curves until after 20 time steps the yield strength is defined by the failed curve. The only way to inhibit this feature is to set  $\sigma_{cut}$  arbitrarily large.

### Response Mode II. Two Curve Model with Damage and Failure

This approach uses two yield versus pressure curves of the form

$$\sigma_y = a_0 + \frac{p}{a_1 + a_2 p}$$

The upper curve is best described as the maximum yield strength curve and the lower curve is the failed material curve. There are a variety of ways of moving between the two curves and each is discussed below.

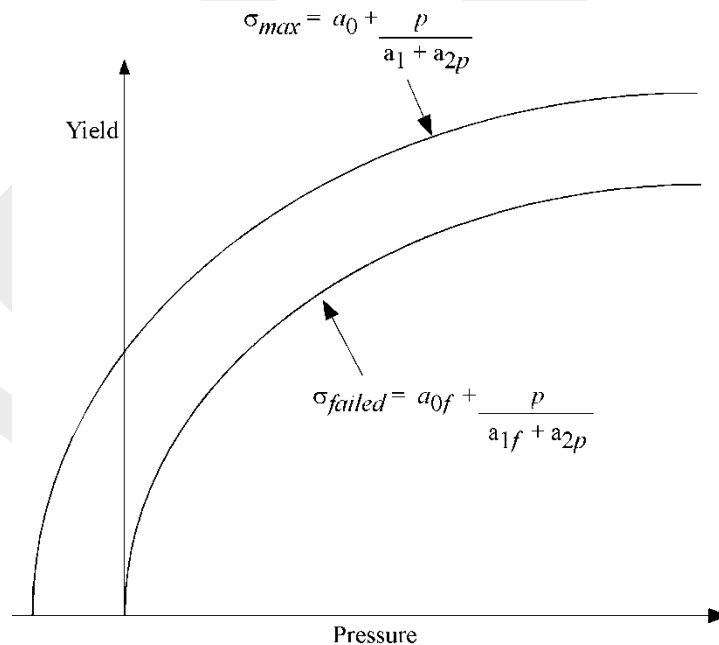

Figure 16.2. Two-curve concrete model with damage and failure.

### MODE II. A: Simple tensile failure

Define  $a_0$ ,  $a_1$ ,  $a_2$ ,  $a_{0f}$  and  $a_{1f}$ , set  $b_1$  to zero, and leave cards 4 through 7 blank. In this case the yield strength is taken from the maximum yield curve until the maximum principal stress ( $\sigma_1$ ) in the element exceeds the tensile cut-off ( $\sigma_{cut}$ ). For every time step that  $\sigma_1 > \sigma_{cut}$  the yield strength is scaled back by a fraction of the distance between the two curves until after 20 time steps the yield strength is defined by the failure curve.

**Mode II.B: Tensile failure plus plastic strain scaling**

Define  $a_0$ ,  $a_1$ ,  $a_2$ ,  $a_{0f}$  and  $a_{1f}$ , set  $b_1$  to zero, and user cards 4 through 7 to define a scale factor,  $\eta$ , versus effective plastic strain. LS-DYNA evaluates  $\eta$  at the current effective plastic strain and then calculated the yield stress as

$$\sigma_{yield} = \sigma_{failed} + \eta(\sigma_{max} - \sigma_{failed})$$

where  $\sigma_{max}$  and  $\sigma_{failed}$  are found as shown in Figure 16.2. This yield strength is then subject to scaling for tensile failure as described above. This type of model allows the description of a strain hardening or softening material such as concrete.

**Mode II.C: Tensile failure plus damage scaling**

The change in yield stress as a function of plastic strain arises from the physical mechanisms such as internal cracking, and the extent of this cracking is affected by the hydrostatic pressure when the cracking occurs. This mechanism gives rise to the "confinement" effect on concrete behavior. To account for this phenomenon, a "damage" function was defined and incorporated. This damage function is given the form:

$$\lambda = \int_0^{\epsilon^p} \left( 1 + \frac{p}{\sigma_{cut}} \right)^{-b_1} d\epsilon^p$$

Define  $a_0$ ,  $a_1$ ,  $a_2$ ,  $a_{0f}$  and  $a_{1f}$ , and  $b_1$ . Cards 4 though 7 now give  $\eta$  as a function of  $\lambda$  and scale the yield stress as

$$\sigma_{yield} = \sigma_{failed} + \eta(\sigma_{max} - \sigma_{failed})$$

and then apply any tensile failure criteria.

**Mode II Concrete Model Options**

Material Type 16 Mode II provides for the automatic internal generation of a simple "generic" model from concrete if A0 is negative then SIGF is assumed to be the unconfined concrete compressive strength,  $f'_c$  and  $-A0$  is assumed to be a conversion factor from LS-DYNA pressure units to psi. (For example, if the model stress units are MPa, A0 should be set to  $-145$ .) In this case the parameter values generated internally are

$$f'_c = SIGF$$

$$\sigma_{cut} = 1.7 \left( \frac{f_c'^2}{-A0} \right)^{\frac{1}{3}}$$

$$a_0 = \frac{f'_c}{4}$$

$$a_1 = \frac{1}{3}$$

$$a_2 = \frac{1}{3f'_c}$$

$$a_{0f} = 0$$

$$a_{1f} = 0.385$$

Note that these  $a_{0f}$  and  $a_{1f}$  defaults will be overridden by non zero entries on Card 3. If plastic strain or damage scaling is desired, Cards 5 through 8 and  $b1$  should be specified in the input. When  $a_0$  is input as a negative quantity, the equation-of-state can be given as 0 and a trilinear EOS Type 8 model will be automatically generated from the unconfined compressive strength and Poisson's ratio. The EOS 8 model is a simple pressure versus volumetric strain model with no internal energy terms, and should give reasonable results for pressures up to 5kbar (approximately 75,000 psi).

### Mixture model

A reinforcement fraction,  $f_r$ , can be defined along with properties of the reinforcement material. The bulk modulus, shear modulus, and yield strength are then calculated from a simple mixture rule, i.e., for the bulk modulus the rule gives:

$$K = (1 - f_r)K_m + f_rK_r$$

where  $K_m$  and  $K_r$  are the bulk moduli for the geologic material and the reinforcement material, respectively. This feature should be used with caution. It gives an isotropic effect in the material instead of the true anisotropic material behavior. A reasonable approach would be to use the mixture elements only where the reinforcing exists and plain elements elsewhere. When the mixture model is being used, the strain rate multiplier for the principal material is taken from load curve N1 and the multiplier for the reinforcement is taken from load curve N2.

### A Suggestion

The LLNL DYNA3D manual from 1991 [Whirley and Hallquist] suggests using the damage function (Mode II.C.) in Material Type 16 with the following set of parameters:

$$a_0 = \frac{f'_c}{4}$$

$$a_1 = \frac{1}{3}$$

$$a_2 = \frac{1}{3f'_c}$$

$$a_{0f} = \frac{f_c'}{10}$$

$$a_{1f} = 1.5$$

$$b_1 = 1.25$$

and a damage table of:

Card 4:	0.0 5.17E-04	8.62E-06 6.38E-04	2.15E-05 7.98E-04	3.14E-05	3.95E-04
Card 5:	9.67E-04 4.00E-03	1.41E-03 4.79E-03	1.97E-03 0.909	2.59E-03	3.27E-03
Card 6:	0.309 0.790	0.543 0.630	0.840 0.469	0.975	1.000
Card 7:	0.383 0.086	0.247 0.056	0.173 0.0	0.136	0.114

This set of parameters should give results consistent with Dilger, Koch, and Kowalczyk, [1984] for plane concrete. It has been successfully used for reinforced structures where the reinforcing bars were modeled explicitly with embedded beam and shell elements. The model does not incorporate the major failure mechanism - separation of the concrete and reinforcement leading to catastrophic loss of confinement pressure. However, experience indicates that this physical behavior will occur when this model shows about 4% strain.



**\*MAT\_ORIENTED\_CRACK**

This is Material Type 17. This material may be used to model brittle materials which fail due to large tensile stresses.

Card 1            1            2            3            4            5            6            7            8

Variable	MID	RO	E	PR	SIGY	ETAN	FS	PRF
Type	A8	F	F	F	F	F	F	F
Default	none	None	none	none	none	0.0	none	0.0

**Optional card for crack propagation to adjacent elements (see remarks):**

Card 2            1            2            3            4            5            6            7            8

Variable	SOFT	CVELO						
Type	F	F						
Default	1.0	0.0						

<u>VARIABLE</u>	<u>DESCRIPTION</u>
MID	Material identification. A unique number or label not exceeding 8 characters must be specified.
RO	Mass density.
E	Young's modulus.
PR	Poisson's ratio.
SIGY	Yield stress.
ETAN	Plastic hardening modulus.
FS	Fracture stress.
PRF	Failure or cutoff pressure ( $\leq 0.0$ ).

VARIABLE	DESCRIPTION
SOFT	Factor by which the fracture stress is reduced when a crack is coming from failed neighboring element. See remarks.
CVELO	Crack propagation velocity. See remarks.

**Remarks:**

This is an isotropic elastic-plastic material which includes a failure model with an oriented crack. The von Mises yield condition is given by:

$$\phi = J_2 - \frac{\sigma_y^2}{3}$$

where the second stress invariant,  $J_2$ , is defined in terms of the deviatoric stress components as

$$J_2 = \frac{1}{2} s_{ij} s_{ij}$$

and the yield stress,  $\sigma_y$ , is a function of the effective plastic strain,  $\epsilon_{eff}^p$ , and the plastic hardening modulus,  $E_p$ :

$$\sigma_y = \sigma_0 + E_p \epsilon_{eff}^p$$

The effective plastic strain is defined as:

$$\epsilon_{eff}^p = \int_0^t d\epsilon_{eff}^p$$

where 
$$d\epsilon_{eff}^p = \sqrt{\frac{2}{3} d\epsilon_{ij}^p d\epsilon_{ij}^p}$$

and the plastic tangent modulus is defined in terms of the input tangent modulus,  $E_t$ , as

$$E_p = \frac{EE_t}{E - E_t}$$

Pressure in this model is found from evaluating an equation of state. A pressure cutoff can be defined such that the pressure is not allowed to fall below the cutoff value.

The oriented crack fracture model is based on a maximum principal stress criterion. When the maximum principal stress exceeds the fracture stress,  $\sigma_f$ , the element fails on a plane perpendicular to the direction of the maximum principal stress. The normal stress and the two shear stresses on that plane are then reduced to zero. This stress reduction is done according to a

delay function that reduces the stresses gradually to zero over a small number of time steps. This delay function procedure is used to reduce the ringing that may otherwise be introduced into the system by the sudden fracture. The number of steps for stress reduction is 20 by default (CVELO=0.0) or it is internally computed if CVELO > 0.0 is given:

$$n_{steps} = \text{int} \left( \frac{L_e}{CVELO \cdot \Delta t} \right)$$

where  $L_e$  is characteristic element length and  $\Delta t$  is time step size.

After a tensile fracture, the element will not support tensile stress on the fracture plane, but in compression will support both normal and shear stresses. The orientation of this fracture surface is tracked throughout the deformation, and is updated to properly model finite deformation effects. If the maximum principal stress subsequently exceeds the fracture stress in another direction, the element fails isotropically. In this case the element completely loses its ability to support any shear stress or hydrostatic tension, and only compressive hydrostatic stress states are possible. Thus, once isotropic failure has occurred, the material behaves like a fluid.

This model is applicable to elastic or elastoplastic materials under significant tensile or shear loading when fracture is expected. Potential applications include brittle materials such as ceramics as well as porous materials such as concrete in cases where pressure hardening effects are not significant.

Crack propagation behavior to adjacent elements can be controlled via parameter SOFT for thin, shell-like structures (e.g. only 2 or 3 solids over thickness). Additionally, LS-DYNA has to know where the plane or solid element midplane is at each integration point for projection of crack plane on this element midplane. Therefore, element numbering has to be as shown in Figure 17.1. Only solid element type 1 is supported with that option at the moment.

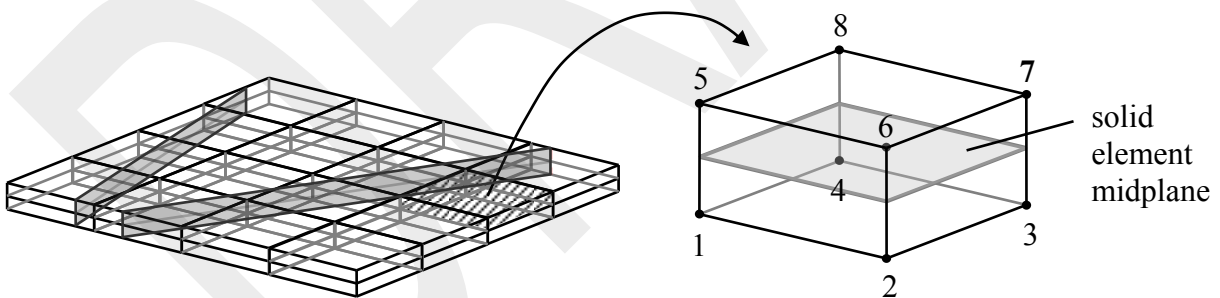

Figure 17.1. Thin structure (2 elements over thickness) with cracks and necessary element numbering

**\*MAT\_POWER\_LAW\_PLASTICITY**

This is Material Type 18. This is an isotropic plasticity model with rate effects which uses a power law hardening rule.

Card 1            1            2            3            4            5            6            7            8

Variable	MID	RO	E	PR	K	N	SRC	SRP
Type	A8	F	F	F	F	F	F	F
Default	none	none	none	none	none	none	0.0	0.0

Card 2            1            2            3            4            5            6            7            8

Variable	SIGY	VP	EPSF					
Type	F	F	F					
Default	0.0	0.0	0.0					

<u>VARIABLE</u>	<u>DESCRIPTION</u>
MID	Material identification. A unique number or label not exceeding 8 characters must be specified.
RO	Mass density.
E	Young's modulus.
PR	Poisson's ratio.
K	Strength coefficient.
N	Hardening exponent.
SRC	Strain rate parameter, C, if zero, rate effects are ignored.
SRP	Strain rate parameter, P, if zero, rate effects are ignored.
SIGY	Optional input parameter for defining the initial yield stress, $\sigma_y$ .

VARIABLE	DESCRIPTION
	Generally, this parameter is not necessary and the strain to yield is calculated as described below. LT.0.02: $\varepsilon_{yp} = SIGY$ GE.0.02: See below.
EPSF	Plastic failure strain for element deletion.
VP	Formulation for rate effects: EQ.0.0: Scale yield stress (default), EQ.1.0: Viscoplastic formulation.

**Remarks:**

Elastoplastic behavior with isotropic hardening is provided by this model. The yield stress,  $\sigma_y$ , is a function of plastic strain and obeys the equation:

$$\sigma_y = k \varepsilon^n = k (\varepsilon_{yp} + \bar{\varepsilon}^p)^n$$

where  $\varepsilon_{yp}$  is the elastic strain to yield and  $\bar{\varepsilon}^p$  is the effective plastic strain (logarithmic). If SIGY is set to zero, the strain to yield is found by solving for the intersection of the linearly elastic loading equation with the strain hardening equation:

$$\begin{aligned}\sigma &= E\varepsilon \\ \sigma &= k \varepsilon^n\end{aligned}$$

which gives the elastic strain at yield as:

$$\varepsilon_{yp} = \left( \frac{E}{k} \right)^{\left[ \frac{1}{n-1} \right]}$$

If SIGY yield is nonzero and greater than 0.02 then:

$$\varepsilon_{yp} = \left( \frac{\sigma_y}{k} \right)^{\left[ \frac{1}{n} \right]}$$

Strain rate is accounted for using the Cowper and Symonds model which scales the yield stress with the factor

$$1 + \left( \frac{\dot{\varepsilon}}{C} \right)^{1/p}$$

where  $\dot{\epsilon}$  is the strain rate. A fully viscoplastic formulation is optional which incorporates the Cowper and Symonds formulation within the yield surface. An additional cost is incurred but the improvement in results can be dramatic.

DRAFT

**\*MAT\_STRAIN\_RATE\_DEPENDENT\_PLASTICITY**

This is Material Type 19. A strain rate dependent material can be defined. For an alternative, see Material Type 24. Required is a curve for the yield stress versus the effective strain rate. Optionally, Young’s modulus and the tangent modulus can also be defined versus the effective strain rate. Also, optional failure of the material can be defined either by defining a von Mises stress at failure as a function of the effective strain rate (valid for solids/shells/thick shells) or by defining a minimum time step size (only for shells).

Card 1            1            2            3            4            5            6            7            8

Variable	MID	RO	E	PR	VP			
Type	A8	F	F	F	F			
Default	none	none	none	none	0.0			

Card 2            1            2            3            4            5            6            7            8

Variable	LC1	ETAN	LC2	LC3	LC4	TDEL	RDEF	
Type	F	F	F	F	F	F	F	
Default	none	0.0	0.0	0.0	0.0	0.0	0.0	

<u>VARIABLE</u>	<u>DESCRIPTION</u>
MID	Material identification. A unique number or label not exceeding 8 characters must be specified.
RO	Mass density.
E	Young’s modulus.
PR	Poisson’s ratio.
VP	Formulation for rate effects: EQ.0.0: Scale yield stress (default), EQ.1.0: Viscoplastic formulation

<u>VARIABLE</u>	<u>DESCRIPTION</u>
LC1	Load curve ID defining the yield stress $\sigma_0$ as a function of the effective strain rate.
ETAN	Tangent modulus, $E_t$
LC2	Load curve ID defining Young's modulus as a function of the effective strain rate (available only when VP=0; not recommended).
LC3	Load curve ID defining tangent modulus as a function of the effective strain rate (optional).
LC4	Load curve ID defining von Mises stress at failure as a function of the effective strain rate (optional).
TDEL	Minimum time step size for automatic element deletion. Use for shells only.
RDEF	Redefinition of failure curve: EQ.1.0: Effective plastic strain, EQ.2.0: Maximum principal stress and absolute value of minimum principal stress, EQ.3.0: Maximum principal stress (release 5 of v.971)

**Remarks:**

In this model, a load curve is used to describe the yield strength  $\sigma_0$  as a function of effective strain rate  $\dot{\bar{\epsilon}}$  where

$$\dot{\bar{\epsilon}} = \left( \frac{2}{3} \dot{\epsilon}'_{ij} \dot{\epsilon}'_{ij} \right)^{1/2}$$

and the prime denotes the deviatoric component. The strain rate is available for post-processing as the first stored history variable. If the viscoplastic option is active, the plastic strain rate is output; otherwise, the effective strain rate defined above is output.

The yield stress is defined as

$$\sigma_y = \sigma_0(\dot{\bar{\epsilon}}) + E_p \bar{\epsilon}^p$$

where  $\bar{\epsilon}^p$  is the effective plastic strain and  $E_p$  is given in terms of Young's modulus and the tangent modulus by



$$E_p = \frac{EE_t}{E - E_t}$$

Both Young's modulus and the tangent modulus may optionally be made functions of strain rate by specifying a load curve ID giving their values as a function of strain rate. If these load curve ID's are input as 0, then the constant values specified in the input are used.

*Note that all load curves used to define quantities as a function of strain rate must have the same number of points at the same strain rate values.* This requirement is used to allow vectorized interpolation to enhance the execution speed of this constitutive model.

This model also contains a simple mechanism for modeling material failure. This option is activated by specifying a load curve ID defining the effective stress at failure as a function of strain rate. For solid elements, once the effective stress exceeds the failure stress the element is deemed to have failed and is removed from the solution. For shell elements the entire shell element is deemed to have failed if all integration points through the thickness have an effective stress that exceeds the failure stress. After failure the shell element is removed from the solution.

In addition to the above failure criterion, this material model also supports a shell element deletion criterion based on the maximum stable time step size for the element,  $\Delta t_{\max}$ . Generally,  $\Delta t_{\max}$  goes down as the element becomes more distorted. To assure stability of time integration, the global LS-DYNA time step is the minimum of the  $\Delta t_{\max}$  values calculated for all elements in the model. Using this option allows the selective deletion of elements whose time step  $\Delta t_{\max}$  has fallen below the specified minimum time step,  $\Delta t_{\text{crit}}$ . Elements which are severely distorted often indicate that material has failed and supports little load, but these same elements may have very small time steps and therefore control the cost of the analysis. This option allows these highly distorted elements to be deleted from the calculation, and, therefore, the analysis can proceed at a larger time step, and, thus, at a reduced cost. Deleted elements do not carry any load, and are deleted from all applicable slide surface definitions. Clearly, this option must be judiciously used to obtain accurate results at a minimum cost.

A fully viscoplastic formulation is optional which incorporates the rate formulation within the yield surface. An additional cost is incurred but the improvement in results can be dramatic.

**\*MAT\_RIGID**

This is Material 20. Parts made from this material are considered to belong to a rigid body (for each part ID). Also, the coupling of a rigid body with MADYMO and CAL3D can be defined via this material. Alternatively, a VDA surface can be attached as surface to model the geometry, e.g., for the tooling in metalforming applications. Also, global and local constraints on the mass center can be optionally defined. Optionally, a local consideration for output and user-defined airbag sensors can be chosen.

Card 1            1            2            3            4            5            6            7            8

Variable	MID	RO	E	PR	N	COUPLE	M	ALIAS RE
Type	A8	F	F	F	F	F	F	C/F
Default	none	none	none	none	0	0	0	Blank none

Card 2            1            2            3            4            5            6            7            8

Variable	CMO	CON1	CON2					
Type	F	F	F					
Default	0	0	0					

Optional for output (Must be included but may be left blank).

Card 3            1            2            3            4            5            6            7            8

Variable	LCO or A1	A2	A3	V1	V2	V3		
Type	F	F	F	F	F	F		
Default	0	0	0	0	0	0		

<u>VARIABLE</u>	<u>DESCRIPTION</u>
MID	Material identification. A unique number or label not exceeding 8 characters must be specified.
RO	Mass density
E	Young's modulus. Reasonable values have to be chosen for contact analysis (choice of penalty), see Remarks below.
PR	Poisson's ratio. Reasonable values have to be chosen for contact analysis (choice of penalty), see Remarks below.
N	MADYMO3D 5.4 coupling flag, n: EQ.0: use normal LS-DYNA rigid body updates, GT.0: the rigid body is coupled to MADYMO 5.4 ellipsoid number n LT.0: the rigid body is coupled to MADYMO 5.4 plane number  n .
COUPLE	Coupling option if applicable: EQ.-1: attach VDA surface in ALIAS (defined in the eighth field) and automatically generate a mesh for viewing the surface in LS-PREPOST. MADYMO 5.4 / CAL3D coupling option: EQ.0: the undeformed geometry input to LS-DYNA corresponds to the local system for MADYMO 5.4 / CAL3D. The finite element mesh is input, EQ.1: the undeformed geometry input to LS-DYNA corresponds to the global system for MADYMO 5.4 / CAL3D, EQ.2: generate a mesh for the ellipsoids and planes internally in LS-DYNA.
M	MADYMO3D 5.4 coupling flag, m: EQ.0: use normal LS-DYNA rigid body updates, EQ.m: this rigid body corresponds to MADYMO rigid body number m. Rigid body updates are performed by MADYMO.

VARIABLE	DESCRIPTION
ALIAS	VDA surface alias name, see Appendix L.
RE	MADYMO 6.0.1 External Reference Number
CMO	Center of mass constraint option, CMO: EQ.+1.0: constraints applied in global directions, EQ. 0.0: no constraints, EQ. -1.0: constraints applied in local directions (SPC constraint).
CON1	First constraint parameter: If CMO=+1.0, then specify global translational constraint: EQ.0: no constraints, EQ.1: constrained x displacement, EQ.2: constrained y displacement, EQ.3: constrained z displacement, EQ.4: constrained x and y displacements, EQ.5: constrained y and z displacements, EQ.6: constrained z and x displacements, EQ.7: constrained x, y, and z displacements. If CMO=-1.0, then specify local coordinate system ID. See *DEFINE_COORDINATE_OPTION: This coordinate system is fixed in time.
CON2	Second constraint parameter: If CMO=+1.0, then specify global rotational constraint: EQ.0: no constraints, EQ.1: constrained x rotation, EQ.2: constrained y rotation, EQ.3: constrained z rotation, EQ.4: constrained x and y rotations, EQ.5: constrained y and z rotations, EQ.6: constrained z and x rotations, EQ.7: constrained x, y, and z rotations. If CMO=-1.0, then specify local (SPC) constraint: EQ.000000 no constraint, EQ.100000 constrained x translation, EQ.010000 constrained y translation, EQ.001000 constrained z translation, EQ.000100 constrained x rotation, EQ.000010 constrained y rotation, EQ.000001 constrained z rotation. Any combination of local constraints can be achieved by adding the number 1 into the corresponding column.
LCO	Local coordinate system number for output.

---

VARIABLE	DESCRIPTION
A1-V3	Alternative method for specifying local system below: Define two vectors <b>a</b> and <b>v</b> , fixed in the rigid body which are used for output and the user defined airbag sensor subroutines. The output parameters are in the directions <b>a</b> , <b>b</b> , and <b>c</b> where the latter are given by the cross products $\mathbf{c}=\mathbf{a}\times\mathbf{v}$ and $\mathbf{b}=\mathbf{c}\times\mathbf{a}$ . This input is optional.

**Remarks:**

The rigid material type 20 provides a convenient way of turning one or more parts comprised of beams, shells, or solid elements into a rigid body. Approximating a deformable body as rigid is a preferred modeling technique in many real world applications. For example, in sheet metal forming problems the tooling can properly and accurately be treated as rigid. In the design of restraint systems the occupant can, for the purposes of early design studies, also be treated as rigid. Elements which are rigid are bypassed in the element processing and no storage is allocated for storing history variables; consequently, the rigid material type is very cost efficient.

Two unique rigid part ID's may not share common nodes unless they are merged together using the rigid body merge option. A rigid body may be made up of disjoint finite element meshes, however. LS-DYNA assumes this is the case since this is a common practice in setting up tooling meshes in forming problems.

All elements which reference a given part ID corresponding to the rigid material should be contiguous, but this is not a requirement. If two disjoint groups of elements on opposite sides of a model are modeled as rigid, separate part ID's should be created for each of the contiguous element groups if each group is to move independently. This requirement arises from the fact that LS-DYNA internally computes the six rigid body degrees-of-freedom for each rigid body (rigid material or set of merged materials), and if disjoint groups of rigid elements use the same part ID, the disjoint groups will move together as one rigid body.

Inertial properties for rigid materials may be defined in either of two ways. By default, the inertial properties are calculated from the geometry of the constituent elements of the rigid material and the density specified for the part ID. Alternatively, the inertial properties and initial velocities for a rigid body may be directly defined, and this overrides data calculated from the material property definition and nodal initial velocity definitions.

Young's modulus,  $E$ , and Poisson's ratio,  $\nu$  are used for determining sliding interface parameters if the rigid body interacts in a contact definition. Realistic values for these constants should be defined since unrealistic values may contribute to numerical problem in contact.

Constraint directions for rigid materials (CMO equal to +1 or -1) are fixed, that is, not updated, with time. To impose a constraint on a rigid body such that the constraint direction is updated as the rigid body rotates, use \*BOUNDARY\_PRESCRIBED\_MOTION\_RIGID\_LOCAL.

If no constraints are specified for the rigid part (CMO=0) the nodes for the part are scanned to determine constraints on the part in global directions. If constraints are specified (CMO equal to +1 or -1) then the nodes are not scanned.

**For coupling with MADYMO 5.4.1, only basic coupling is available.**

The coupling flags (N and M) must match with SYSTEM and ELLIPSOID/PLANE in the MADYMO input file and the coupling option (COUPLE) must be defined.

**For coupling with MADYMO 6.0.1, both basic and extended coupling are available:**

- (1) Basic Coupling: The external reference number (RE) must match with the external reference number in the MADYMO XML input file. The coupling option (COUPLE) must be defined.
- (2) Extended Coupling: Under this option MADYMO will handle the contact between the MADYMO and LS-DYNA models. The external reference number (RE) and the coupling option (COUPLE) are not needed. All coupling surfaces that interface with the MADYMO models need to be defined in \*CONTACT\_COUPLING.

\*MAT\_ORTHOTROPIC\_THERMAL

This is Material Type 21. A linearly elastic, orthotropic material with orthotropic thermal expansion.

Card 1            1            2            3            4            5            6            7            8

Variable	MID	RO	EA	EB	EC	PRBA	PRCA	PRCB
Type	A8	F	F	F	F	F	F	F

Card 2            1            2            3            4            5            6            7            8

Variable	GAB	GBC	GCA	AA	AB	AC	AOPT	MACF
Type	F	F	F	F	F	F	F	I

Card 3            1            2            3            4            5            6            7            8

Variable	XP	YP	ZP	A1	A2	A3		
Type	F	F	F	F	F	F		

Card 4            1            2            3            4            5            6            7            8

Variable	V1	V2	V3	D1	D2	D3	BETA	REF
Type	F	F	F	F	F	F	F	

**VARIABLE**

**DESCRIPTION**

- MID            Material identification. A unique number or label not exceeding 8 characters must be specified.
- RO            Mass density.

<b>VARIABLE</b>	<b>DESCRIPTION</b>
EA	$E_a$ , Young's modulus in a-direction.
EB	$E_b$ , Young's modulus in b-direction.
EC	$E_c$ , Young's modulus in c-direction.
PRBA	$\nu_{ba}$ , Poisson's ratio, ba.
PRCA	$\nu_{ca}$ , Poisson's ratio, ca.
PRCB	$\nu_{cb}$ , Poisson's ratio, cb.
GAB	$G_{ab}$ , Shear modulus, ab.
GBC	$G_{bc}$ , Shear modulus, bc.
GCA	$G_{ca}$ , Shear modulus, ca.
AA	$\alpha_a$ , coefficients of thermal expansion in the a-direction.
AB	$\alpha_b$ , coefficients of thermal expansion in the b-direction.
AC	$\alpha_c$ , coefficients of thermal expansion in the c-direction.



VARIABLE	DESCRIPTION
AOPT	<p>Material axes option (see MAT_OPTION TROPIC_ELASTIC for a more complete description):</p> <p>EQ. 0.0: locally orthotropic with material axes determined by element nodes 1, 2, and 4, as with *DEFINE_COORDINATE_NODES.</p> <p>EQ. 1.0: locally orthotropic with material axes determined by a point in space and the global location of the element center; this is the a-direction. This option is for solid elements only.</p> <p>EQ. 2.0: globally orthotropic with material axes determined by vectors defined below, as with *DEFINE_COORDINATE_VECTOR.</p> <p>EQ. 3.0: locally orthotropic material axes determined by rotating the material axes about the element normal by an angle, BETA, from a line in the plane of the element defined by the cross product of the vector <b>v</b> with the element normal.</p> <p>EQ. 4.0: locally orthotropic in cylindrical coordinate system with the material axes determined by a vector <b>v</b>, and an originating point, P, which define the centerline axis. This option is for solid elements only.</p> <p>LT.0.0: the absolute value of AOPT is a coordinate system ID number (CID on *DEFINE_COORDINATE_NODES, *DEFINE_COORDINATE_SYSTEM or *DEFINE_COORDINATE_VECTOR). Available in R3 version of 971 and later.</p>
MACF	<p>Material axes change flag for brick elements:</p> <p>EQ.1: No change, default,</p> <p>EQ.2: switch material axes a and b,</p> <p>EQ.3: switch material axes a and c,</p> <p>EQ.4: switch material axes b and c.</p>
XP,YP,ZP	<p>Coordinates of point <b>p</b> for AOPT = 1.</p>
A1,A2,A3	<p>Components of vector <b>a</b> for AOPT = 2.</p>
V1,V2,V3	<p>Components of vector <b>v</b> for AOPT = 3.</p>
D1,D2,D3	<p>Components of vector <b>d</b> for AOPT = 2.</p>
BETA	<p>Material angle in degrees for AOPT = 3, may be overridden on the element card, see *ELEMENT_SHELL_BETA or *ELEMENT_SOLID_ORTHO.</p>

VARIABLE	DESCRIPTION
REF	Use reference geometry to initialize the stress tensor. The reference geometry is defined by the keyword: *INITIAL_FOAM_REFERENCE_GEOMETRY (see there for more details). EQ.0.0: off, EQ.1.0: on.

**Remarks:**

In the implementation for three-dimensional continua a total Lagrangian formulation is used. In this approach the material law that relates second Piola-Kirchhoff stress  $S$  to the Green-St. Venant strain  $E$  is

$$S = C \cdot E = T' C_l T \cdot E$$

where  $T$  is the transformation matrix [Cook 1974].

$$T = \begin{bmatrix} l_1^2 & m_1^2 & n_1^2 & l_1 m_1 & m_1 n_1 & n_1 l_1 \\ l_2^2 & m_2^2 & n_2^2 & l_2 m_2 & m_2 n_2 & n_2 l_2 \\ l_3^2 & m_3^2 & n_3^2 & l_3 m_3 & m_3 n_3 & n_3 l_3 \\ 2l_1 l_2 & 2m_1 m_2 & 2n_1 n_2 & (l_1 m_2 + l_2 m_1) & (m_1 n_2 + m_2 n_1) & (n_1 l_2 + n_2 l_1) \\ 2l_2 l_3 & 2m_2 m_3 & 2n_2 n_3 & (l_2 m_3 + l_3 m_2) & (m_2 n_3 + m_3 n_2) & (n_2 l_3 + n_3 l_2) \\ 2l_3 l_1 & 2m_3 m_1 & 2n_3 n_1 & (l_3 m_1 + l_1 m_3) & (m_3 n_1 + m_1 n_3) & (n_3 l_1 + n_1 l_3) \end{bmatrix}$$

$l_i, m_i, n_i$  are the direction cosines

$$x'_i = l_i x_1 + m_i x_2 + n_i x_3 \quad \text{for } i = 1, 2, 3$$

and  $x'_i$  denotes the material axes. The constitutive matrix  $C_l$  is defined in terms of the material axes as

$$C_l^{-1} = \begin{bmatrix} \frac{1}{E_{11}} & -\frac{\nu_{21}}{E_{22}} & -\frac{\nu_{31}}{E_{33}} & 0 & 0 & 0 \\ -\frac{\nu_{12}}{E_{11}} & \frac{1}{E_{22}} & -\frac{\nu_{32}}{E_{33}} & 0 & 0 & 0 \\ -\frac{\nu_{13}}{E_{11}} & -\frac{\nu_{23}}{E_{22}} & \frac{1}{E_{33}} & 0 & 0 & 0 \\ 0 & 0 & 0 & \frac{1}{G_{12}} & 0 & 0 \\ 0 & 0 & 0 & 0 & \frac{1}{G_{23}} & 0 \\ 0 & 0 & 0 & 0 & 0 & \frac{1}{G_{31}} \end{bmatrix}$$

where the subscripts denote the material axes, i.e.,

$$\nu_{ij} = \nu_{x_i x_j} \quad \text{and} \quad E_{ii} = E_{x_i}$$

Since  $C_l$  is symmetric

$$\frac{\nu_{12}}{E_{11}} = \frac{\nu_{21}}{E_{22}}, \text{ etc.}$$

The vector of Green-St. Venant strain components is

$$E^t = [E_{11}, E_{22}, E_{33}, E_{12}, E_{23}, E_{31}]$$

which include the local thermal strains which are integrated in time:

$$\varepsilon_{aa}^{n+1} = \varepsilon_{aa}^n + \alpha_a (T^{n+1} - T^n)$$

$$\varepsilon_{bb}^{n+1} = \varepsilon_{bb}^n + \alpha_b (T^{n+1} - T^n)$$

$$\varepsilon_{cc}^{n+1} = \varepsilon_{cc}^n + \alpha_c (T^{n+1} - T^n)$$

After computing  $S_{ij}$  we then obtain the Cauchy stress:

$$\sigma_{ij} = \frac{\rho}{\rho_0} \frac{\partial x_i}{\partial X_k} \frac{\partial x_j}{\partial X_l} S_{kl}$$

This model will predict realistic behavior for finite displacement and rotations as long as the strains are small.

In the implementation for shell elements, the stresses are integrated in time and are updated in the corotational coordinate system. In this procedure the local material axes are assumed to

remain orthogonal in the deformed configuration. This assumption is valid if the strains remain small.



\*MAT\_COMPOSITE\_DAMAGE

This is Material Type 22. An orthotropic material with optional brittle failure for composites can be defined following the suggestion of [Chang and Chang 1987a, 1987b]. Three failure criteria are possible, see the LS-DYNA Theory Manual. By using the user defined integration rule, see \*INTEGRATION\_SHELL, the constitutive constants can vary through the shell thickness. For all shells, except the DKT formulation, laminated shell theory can be activated to properly model the transverse shear deformation. Lamination theory is applied to correct for the assumption of a uniform constant shear strain through the thickness of the shell. For sandwich shells where the outer layers are much stiffer than the inner layers, the response will tend to be too stiff unless lamination theory is used. To turn on lamination theory see \*CONTROL\_SHELL.

Card 1            1            2            3            4            5            6            7            8

Variable	MID	RO	EA	EB	EC	PRBA	PRCA	PRCB
Type	A8	F	F	F	F	F	F	F
Default	none	None	none	none	none	none	none	none

Card 2            1            2            3            4            5            6            7            8

Variable	GAB	GBC	GCA	KFAIL	AOPT	MACF		
Type	F	F	F	F	F	I		
Default	none	None	none	0.0	0.0	0		

Card 3            1            2            3            4            5            6            7            8

Variable	XP	YP	ZP	A1	A2	A3		
Type	F	F	F	F	F	F		
Default	0.0	0.0	0.0	0.0	0.0	0.0		

Card 4            1            2            3            4            5            6            7            8

Variable	V1	V2	V3	D1	D2	D3	BETA	
Type	F	F	F	F	F	F	F	
Default	0.0	0.0	0.0	0.0	0.0	0.0	0.0	

Card 5            1            2            3            4            5            6            7            8

Variable	SC	XT	YT	YC	ALPH	SN	SYZ	SZX
Type	F	F	F	F	F	F	F	F
Default	none	none	none	none	none	none	none	none

**VARIABLE****DESCRIPTION**

MID	Material identification. A unique number or label not exceeding 8 characters must be specified.
RO	Mass density
EA	$E_a$ , Young's modulus in a-direction.
EB	$E_b$ , Young's modulus in b-direction.
EC	$E_c$ , Young's modulus in c-direction.
PRBA	$\nu_{ba}$ , Poisson ratio, ba.
PRCA	$\nu_{ca}$ , Poisson ratio, ca.
PRCB	$\nu_{cb}$ , Poisson ratio, cb.
GAB	$G_{ab}$ , Shear modulus, ab.
GBC	$G_{bc}$ , Shear modulus, bc.
GCA	$G_{ca}$ , Shear modulus, ca.

VARIABLE	DESCRIPTION
KFAIL	Bulk modulus of failed material. Necessary for compressive failure.
AOPT	<p>Material axes option (see MAT_OPTION TROPIC_ELASTIC for a more complete description):</p> <p>EQ. 0.0: locally orthotropic with material axes determined by element nodes 1, 2, and 4, as with *DEFINE_COORDINATE_NODES.</p> <p>EQ. 1.0: locally orthotropic with material axes determined by a point in space and the global location of the element center; this is the a-direction. This option is for solid elements only.</p> <p>EQ. 2.0: globally orthotropic with material axes determined by vectors defined below, as with *DEFINE_COORDINATE_VECTOR.</p> <p>EQ. 3.0: locally orthotropic material axes determined by rotating the material axes about the element normal by an angle, BETA, from a line in the plane of the element defined by the cross product of the vector <b>v</b> with the element normal.</p> <p>EQ. 4.0: locally orthotropic in cylindrical coordinate system with the material axes determined by a vector <b>v</b>, and an originating point, P, which define the centerline axis. This option is for solid elements only.</p> <p>LT.0.0: the absolute value of AOPT is a coordinate system ID number (CID on *DEFINE_COORDINATE_NODES, *DEFINE_COORDINATE_SYSTEM or *DEFINE_COORDINATE_VECTOR). Available in R3 version of 971 and later.</p>
MACF	<p>Material axes change flag for brick elements:</p> <p>EQ.1: No change, default,</p> <p>EQ.2: switch material axes a and b,</p> <p>EQ.3: switch material axes a and c,</p> <p>EQ.4: switch material axes b and c.</p>
XP,YP,ZP	Coordinates of point <b>p</b> for AOPT = 1.
A1,A2,A3	Components of vector <b>a</b> for AOPT = 2.
V1,V2,V3	Components of vector <b>v</b> for AOPT = 3.
D1,D2,D3	Components of vector <b>d</b> for AOPT = 2.
BETA	Material angle in degrees for AOPT = 3, may be overridden on the element card, see *ELEMENT_SHELL_BETA or *ELEMENT_SOLID_ORTHO.
SC	Shear strength, ab plane, see the LS-DYNA Theory Manual.

<u>VARIABLE</u>	<u>DESCRIPTION</u>
XT	Longitudinal tensile strength, a-axis, see the LS-DYNA Theory Manual.
YT	Transverse tensile strength, b-axis.
YC	Transverse compressive strength, b-axis (positive value).
ALPH	Shear stress parameter for the nonlinear term, see the LS-DYNA Theory Manual. Suggested range 0 – 0.5.
SN	Normal tensile strength ( <i>solid elements only</i> )
SYZ	Transverse shear strength ( <i>solid elements only</i> )
SZX	Transverse shear strength ( <i>solid elements only</i> )

**Remarks:**

The number of additional integration point variables for shells written to the d3plot database is input by the optional \*DATABASE\_EXTENT\_BINARY as variable NEIPS. These additional variables are tabulated below (*ip* = shell integration point):

History Variable	Description	Value	LS-PrePost history variable
<i>ef(i)</i>	<i>tensile fiber mode</i>	<i>1 - elastic 0 - failed</i>	<i>1</i>
<i>cm(i)</i>	<i>tensile matrix mode</i>		<i>2</i>
<i>ed(i)</i>	<i>compressive matrix mode</i>		<i>3</i>

These variables can be plotted in LS-PrePost as element history variables 1, 2, and 3. The following components are stored as element component 7 instead of the effective plastic strain.

Description	Integration point
$\frac{1}{nip} \sum_{i=1}^{nip} ef(i)$	<i>1</i>
$\frac{1}{nip} \sum_{i=1}^{nip} cm(i)$	<i>2</i>
$\frac{1}{nip} \sum_{i=1}^{nip} ed(i)$	<i>3</i>



\*MAT\_TEMPERATURE\_DEPENDENT\_ORTHOTROPIC

This is Material Type 23. An orthotropic elastic material with arbitrary temperature dependency can be defined.

Card 1            1            2            3            4            5            6            7            8

Variable	MID	RO	AOPT	REF	MACF			
Type	A8	F	F	F	I			

Card 2            1            2            3            4            5            6            7            8

Variable	XP	YP	ZP	A1	A2	A3		
Type	F	F	F	F	F	F		

Card 3            1            2            3            4            5            6            7            8

Variable	V1	V2	V3	D1	D2	D3	BETA	
Type	F	F	F	F	F	F	F	

**Define one set of constants on two cards for each temperature point. Up to 48 points (96 cards) can be defined. The next “\*” card terminates the input.**

Card 1 for Temperature Ti            1            2            3            4            5            6            7            8

Variable	E <sub>Ai</sub>	E <sub>Bi</sub>	E <sub>Ci</sub>	PR <sub>BAi</sub>	PR <sub>CAi</sub>	PR <sub>CBi</sub>		
Type	F	F	F	F	F	F		

Card 2 for  
Temperature  
Ti

1            2            3            4            5            6            7            8

Variable	AAi	ABi	ACi	GABi	GBCi	GCAi	Ti	
Type	F	F	F	F	F	F	F	

<u>VARIABLE</u>	<u>DESCRIPTION</u>
MID	Material identification. A unique number or label not exceeding 8 characters must be specified.
RO	Mass density.
AOPT	<p>Material axes option (see <i>MAT_OPTION TROPIC_ELASTIC</i> for a more complete description):</p> <p>EQ. 0.0: locally orthotropic with material axes determined by element nodes 1, 2, and 4, as with <i>*DEFINE_COORDINATE_NODES</i>.</p> <p>EQ. 1.0: locally orthotropic with material axes determined by a point in space and the global location of the element center; this is the a-direction. This option is for solid elements only.</p> <p>EQ. 2.0: globally orthotropic with material axes determined by vectors defined below, as with <i>*DEFINE_COORDINATE_VECTOR</i>.</p> <p>EQ. 3.0: locally orthotropic material axes determined by rotating the material axes about the element normal by an angle, BETA, from a line in the plane of the element defined by the cross product of the vector v with the element normal.</p> <p>EQ. 4.0: locally orthotropic in cylindrical coordinate system with the material axes determined by a vector v, and an originating point, P, which define the centerline axis. This option is for solid elements only.</p> <p>LT.0.0: the absolute value of AOPT is a coordinate system ID number (CID on <i>*DEFINE_COORDINATE_NODES</i>, <i>*DEFINE_COORDINATE_SYSTEM</i> or <i>*DEFINE_COORDINATE_VECTOR</i>). Available in R3 version of 971 and later.</p>
REF	<p>Use reference geometry to initialize the stress tensor. The reference geometry is defined by the keyword:<i>*INITIAL_FOAM_REFERENCE_GEOMETRY</i> (see for more details).</p> <p>EQ.0.0: off, EQ.1.0: on.</p>

VARIABLE	DESCRIPTION
MACF	Material axes change flag for brick elements: EQ.1: No change, default, EQ.2: switch material axes a and b, EQ.3: switch material axes a and c, EQ.4: switch material axes b and c.
XP,YP,ZP	Coordinates of point <b>p</b> for AOPT = 1.
A1,A2,A3	Components of vector <b>a</b> for AOPT = 2.
V1,V2,V3	Components of vector <b>v</b> for AOPT = 3.
D1,D2,D3	Components of vector <b>d</b> for AOPT = 2.
BETA	Material angle in degrees for AOPT = 3, may be overridden on the element card, see *ELEMENT_SHELL_BETA or *ELEMENT_SOLID_ORTHO.
EAI	$E_a$ , Young's modulus in a-direction at temperature $T_i$ .
EBI	$E_b$ , Young's modulus in b-direction at temperature $T_i$ .
ECI	$E_c$ , Young's modulus in c-direction at temperature $T_i$ .
PRBAI	$\nu_{ba}$ , Poisson's ratio ba at temperature $T_i$ .
PRCAI	$\nu_{ca}$ , Poisson's ratio ca at temperature $T_i$ .
PRCBI	$\nu_{cb}$ , Poisson's ratio cb at temperature $T_i$ .
AAI	$\alpha_a$ , coefficient of thermal expansion in a-direction at temperature $T_i$ .
ABI	$\alpha_b$ , coefficient of thermal expansion in b-direction at temperature $T_i$ .
ACI	$\alpha_c$ , coefficient of thermal expansion in c-direction at temperature $T_i$ .
GABI	$G_{ab}$ , Shear modulus ab at temperature $T_i$ .
GBCI	$G_{bc}$ , Shear modulus bc at temperature $T_i$ .
GCAI	$G_{ca}$ , Shear modulus ca at temperature $T_i$ .
Ti	$i$ th temperature

**Remarks:**

In the implementation for three-dimensional continua a total Lagrangian formulation is used. In this approach the material law that relates second Piola-Kirchhoff stress  $S$  to the Green-St. Venant strain  $E$  is

$$S = C \cdot E = T' C_i T \cdot E$$

where  $T$  is the transformation matrix [Cook 1974].

$$T = \begin{bmatrix} l_1^2 & m_1^2 & n_1^2 & l_1 m_1 & m_1 n_1 & n_1 l_1 \\ l_2^2 & m_2^2 & n_2^2 & l_2 m_2 & m_2 n_2 & n_2 l_2 \\ l_3^2 & m_3^2 & n_3^2 & l_3 m_3 & m_3 n_3 & n_3 l_3 \\ 2l_1 l_2 & 2m_1 m_2 & 2n_1 n_2 & (l_1 m_2 + l_2 m_1) & (m_1 n_2 + m_2 n_1) & (n_1 l_2 + n_2 l_1) \\ 2l_2 l_3 & 2m_2 m_3 & 2n_2 n_3 & (l_2 m_3 + l_3 m_2) & (m_2 n_3 + m_3 n_2) & (n_2 l_3 + n_3 l_2) \\ 2l_3 l_1 & 2m_3 m_1 & 2n_3 n_1 & (l_3 m_1 + l_1 m_3) & (m_3 n_1 + m_1 n_3) & (n_3 l_1 + n_1 l_3) \end{bmatrix}$$

$l_i, m_i, n_i$  are the direction cosines

$$x'_i = l_i x_1 + m_i x_2 + n_i x_3 \quad \text{for } i = 1, 2, 3$$

and  $x'_i$  denotes the material axes. The temperature dependent constitutive matrix  $C_i$  is defined in terms of the material axes as

$$C_i^{-1} = \begin{bmatrix} \frac{1}{E_{11}(T)} & -\frac{\nu_{13}(T)}{E_{11}(T)} & -\frac{\nu_{31}(T)}{E_{33}(T)} & 0 & 0 & 0 \\ -\frac{\nu_{12}(T)}{E_{11}(T)} & \frac{1}{E_{22}(T)} & -\frac{\nu_{32}(T)}{E_{33}(T)} & 0 & 0 & 0 \\ -\frac{\nu_{13}(T)}{E_{11}(T)} & -\frac{\nu_{23}(T)}{E_{22}(T)} & \frac{1}{E_{33}(T)} & 0 & 0 & 0 \\ 0 & 0 & 0 & \frac{1}{G_{12}(T)} & 0 & 0 \\ 0 & 0 & 0 & 0 & \frac{1}{G_{23}(T)} & 0 \\ 0 & 0 & 0 & 0 & 0 & \frac{1}{G_{31}(T)} \end{bmatrix}$$

where the subscripts denote the material axes, i.e.,

$$\nu_{ij} = \nu_{x'_i x'_j} \quad \text{and} \quad E_{ii} = E_{x'_i}$$

Since  $C_I$  is symmetric

$$\frac{\nu_{12}}{E_{11}} = \frac{\nu_{21}}{E_{22}}, \text{ etc.}$$

The vector of Green-St. Venant strain components is

$$E^t = [E_{11}, E_{22}, E_{33}, E_{12}, E_{23}, E_{31}]$$

which include the local thermal strains which are integrated in time:

$$\epsilon_{aa}^{n+1} = \epsilon_{aa}^n + \alpha_a \left( T^{n+\frac{1}{2}} \right) [T^{n+1} - T^n]$$

$$\epsilon_{bb}^{n+1} = \epsilon_{bb}^n + \alpha_b \left( T^{n+\frac{1}{2}} \right) [T^{n+1} - T^n]$$

$$\epsilon_{cc}^{n+1} = \epsilon_{cc}^n + \alpha_c \left( T^{n+\frac{1}{2}} \right) [T^{n+1} - T^n]$$

After computing  $S_{ij}$  we then obtain the Cauchy stress:

$$\sigma_{ij} = \frac{\rho}{\rho_0} \frac{\partial x_i}{\partial X_k} \frac{\partial x_j}{\partial X_l} S_{kl}$$

This model will predict realistic behavior for finite displacement and rotations as long as the strains are small.

For shell elements, the stresses are integrated in time and are updated in the corotational coordinate system. In this procedure the local material axes are assumed to remain orthogonal in the deformed configuration. This assumption is valid if the strains remain small.

**\*MAT\_PIECEWISE\_LINEAR\_PLASTICITY**

This is Material Type 24. An elasto-plastic material with an arbitrary stress versus strain curve and arbitrary strain rate dependency can be defined. See also Remark below. Also, failure based on a plastic strain or a minimum time step size can be defined. For another model with a more comprehensive failure criteria see MAT\_MODIFIED\_PIECEWISE\_LINEAR\_PLASTICITY. If considering laminated or sandwich shells with non-uniform material properties (this is defined through the user specified integration rule), the model, MAT\_LAYERED\_LINEAR\_PLASTICITY, is recommended. If solid elements are used and if the elastic strains before yielding are finite, the model, MAT\_FINITE\_ELASTIC\_STRAIN\_PLASTICITY, treats the elastic strains using a hyperelastic formulation.

Card 1            1            2            3            4            5            6            7            8

Variable	MID	RO	E	PR	SIGY	ETAN	FAIL	TDEL
Type	A8	F	F	F	F	F	F	F
Default	none	none	none	none	none	0.0	10.E+20	0

Card 2            1            2            3            4            5            6            7            8

Variable	C	P	LCSS	LCSR	VP			
Type	F	F	F	F	F			
Default	0	0	0	0	0			

Card 3            1            2            3            4            5            6            7            8

Variable	EPS1	EPS2	EPS3	EPS4	EPS5	EPS6	EPS7	EPS8
Type	F	F	F	F	F	F	F	F
Default	0	0	0	0	0	0	0	0

Card 4            1            2            3            4            5            6            7            8

Variable	ES1	ES2	ES3	ES4	ES5	ES6	ES7	ES8
Type	F	F	F	F	F	F	F	F
Default	0	0	0	0	0	0	0	0

**VARIABLE****DESCRIPTION**

MID	Material identification. A unique number or label not exceeding 8 characters must be specified.
RO	Mass density.
E	Young's modulus.
PR	Poisson's ratio.
SIGY	Yield stress.
ETAN	Tangent modulus, ignored if (LCSS.GT.0) is defined.
FAIL	Failure flag. LT.0.0: User defined failure subroutine, matusr_24 in dyn21.F, is called to determine failure EQ.0.0: Failure is not considered. This option is recommended if failure is not of interest since many calculations will be saved. GT.0.0: Effective plastic strain to failure. When the plastic strain reaches this value, the element is deleted from the calculation.
TDEL	Minimum time step size for automatic element deletion.
C	Strain rate parameter, C, see formula below.
P	Strain rate parameter, P, see formula below.

VARIABLE	DESCRIPTION
LCSS	<p>Load curve ID or Table ID (optional; supersedes SIGY, ETAN, EPS1-8, ES1-8). Load curve ID defining effective stress versus effective plastic strain. If defined EPS1-EPS8 and ES1-ES8 are ignored. The table ID defines for each strain rate value a load curve ID giving the stress versus effective plastic strain for that rate, See Figure 24.1. The stress versus effective plastic strain curve for the lowest value of strain rate is used if the strain rate falls below the minimum value. Likewise, the stress versus effective plastic strain curve for the highest value of strain rate is used if the strain rate exceeds the maximum value. The strain rate parameters: C and P; the curve ID, LCSR; EPS1-EPS8 and ES1-ES8 are ignored if a Table ID is defined. <u>NOTE</u>: The strain rate values defined in the table may be given as the natural logarithm of the strain rate. If the <i>first</i> stress-strain curve in the table corresponds to a negative strain rate, LS-DYNA assumes that the natural logarithm of the strain rate value is used. Since the tables are internally discretized to equally space the points, natural logarithms are necessary, for example, if the curves correspond to rates from 10.e-04 to 10.e+04. Computing the natural logarithm of the strain rate does slow the stress update down significantly on some computers.</p>
LCSR	<p>Load curve ID defining strain rate scaling effect on yield stress. If LCSR is negative, the load curve is evaluated using a binary search for the correct interval for the strain rate. The binary search is slower than the default incremental search, but in cases where large changes in the strain rate may occur over a single time step, it is more robust. This option is not necessary for the viscoplastic formulation.</p>
VP	<p>Formulation for rate effects: EQ.-1.0: Cowper-Symonds with deviatoric strain rate rather than total, EQ.0.0: Scale yield stress (default), EQ.1.0: Viscoplastic formulation.</p>
EPS1-EPS8	<p>Effective plastic strain values (optional; supersedes SIGY, ETAN). At least 2 points should be defined. The first point must be zero corresponding to the initial yield stress. <b>WARNING</b>: If the first point is nonzero the yield stress is extrapolated to determine the initial yield. If this option is used SIGY and ETAN are ignored and may be input as zero.</p>
ES1-ES8	<p>Corresponding yield stress values to EPS1 - EPS8.</p>



**Remarks:**

The stress strain behavior may be treated by a bilinear stress strain curve by defining the tangent modulus, ETAN. Alternately, a curve of effective stress vs. effective plastic strain similar to that shown in Figure 10.1 may be defined by (EPS1,ES1) - (EPS8,ES8); however, a curve ID (LCSS) may be referenced instead if eight points are insufficient. The cost is roughly the same for either approach. Note that in the special case of uniaxial stress, true stress vs. true plastic strain is equivalent to effective stress vs. effective plastic strain. The most general approach is to use the table definition (LCSS) discussed below.

Three options to account for strain rate effects are possible.

- I. Strain rate may be accounted for using the Cowper and Symonds model which scales the yield stress with the factor

$$1 + \left( \frac{\dot{\epsilon}}{C} \right)^{1/p}$$

where  $\dot{\epsilon}$  is the strain rate.  $\dot{\epsilon} = \sqrt{\dot{\epsilon}_{ij} \dot{\epsilon}_{ij}}$ . If VP=-1. The deviatoric strain rates are used instead.

If the viscoplastic option is active, VP=1.0, and if SIGY is > 0 then the dynamic yield stress is computed from the sum of the static stress,  $\sigma_y^s(\epsilon_{eff}^p)$ , which is typically given by a load curve ID, and the initial yield stress, SIGY, multiplied by the Cowper-Symonds rate term as follows:

$$\sigma_y(\epsilon_{eff}^p, \dot{\epsilon}_{eff}^p) = \sigma_y^s(\epsilon_{eff}^p) + SIGY \cdot \left( \frac{\dot{\epsilon}_{eff}^p}{C} \right)^{1/p}$$

where the plastic strain rate is used. With this latter approach similar results can be obtained between this model and material model: \*MAT\_ANISOTROPIC\_VISCOPLASTIC. If SIGY=0, the following equation is used instead where the static stress,  $\sigma_y^s(\epsilon_{eff}^p)$ , must be defined by a load curve:

$$\sigma_y(\epsilon_{eff}^p, \dot{\epsilon}_{eff}^p) = \sigma_y^s(\epsilon_{eff}^p) \left[ 1 + \left( \frac{\dot{\epsilon}_{eff}^p}{C} \right)^{1/p} \right]$$

This latter equation is always used if the viscoplastic option is off.

- II. For complete generality a load curve (LCSR) to scale the yield stress may be input instead. In this curve the scale factor versus strain rate is defined.
- III. If different stress versus strain curves can be provided for various strain rates, the option using the reference to a table (LCSS) can be used. Then the table input in \*DEFINE\_TABLE has to be used, see Figure 24.1.

A fully viscoplastic formulation is optional (variable VP) which incorporates the different options above within the yield surface. An additional cost is incurred over the simple scaling but the improvement in results can be dramatic.

DRAFT

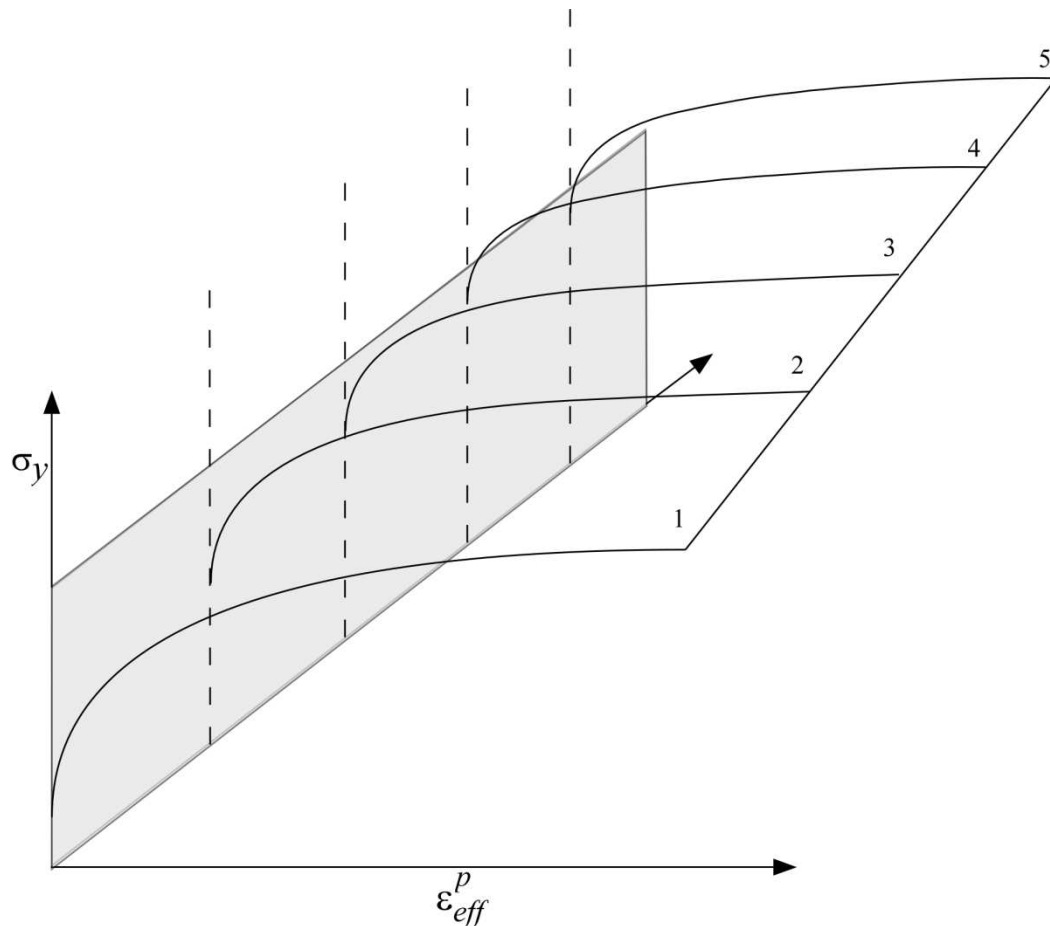

**Figure 24.1.** Rate effects may be accounted for by defining a table of curves. If a table ID is specified a curve ID is given for each strain rate, see \*DEFINE\_TABLE. Intermediate values are found by interpolating between curves. Effective plastic strain versus yield stress is expected. If the strain rate values fall out of range, extrapolation is not used; rather, either the first or last curve determines the yield stress depending on whether the rate is low or high, respectively.

**\*MAT\_GEOLOGIC\_CAP\_MODEL**

This is Material Type 25. This is an inviscid two invariant geologic cap model. This material model can be used for geomechanical problems or for materials as concrete, see references cited below.

Card 1            1            2            3            4            5            6            7            8

Variable	MID	RO	BULK	G	ALPHA	THETA	GAMMA	BETA
Type	A8	F	F	F	F	F	F	F

Card 2            1            2            3            4            5            6            7            8

Variable	R	D	W	X0	C	N		
Type	F	F	F	F	F	F		

Card 3            1            2            3            4            5            6            7            8

Variable	PLOT	FTYPE	VEC	TOFF				
Type	F	F	F	F				

<u>VARIABLE</u>	<u>DESCRIPTION</u>
MID	Material identification. A unique number or label not exceeding 8 characters must be specified.
RO	Mass density.
BULK	Initial bulk modulus, K.
G	Initial Shear modulus.
ALPHA	Failure envelope parameter, $\alpha$ .
THETA	Failure envelope linear coefficient, $\theta$ .

<u>VARIABLE</u>	<u>DESCRIPTION</u>
GAMMA	Failure envelope exponential coefficient, $\gamma$ .
BETA	Failure envelope exponent, $\beta$ .
R	Cap, surface axis ratio.
D	Hardening law exponent.
W	Hardening law coefficient.
X0	Hardening law exponent, $X_0$ .
C	Kinematic hardening coefficient, $\bar{c}$ .
N	Kinematic hardening parameter.
PLOT	Save the following variable for plotting in LS-PrePost, to be labeled there as "effective plastic strain:" EQ.1: hardening parameter, $\kappa$ EQ.2: cap - $J_1$ axis intercept, $X$ ( $\kappa$ ) EQ.3: volumetric plastic strain $\varepsilon_v^p$ EQ.4: first stress invariant, $J_1$ EQ.5: second stress invariant, $\sqrt{J_2}$ EQ.6: not used EQ.7: not used EQ.8: response mode number EQ.9: number of iterations
FTYPE	Formulation flag: EQ.1: soils (Cap surface may contract) EQ.2: concrete and rock (Cap doesn't contract)
VEC	Vectorization flag: EQ.0: vectorized (fixed number of iterations) EQ.1: fully iterative If the vectorized solution is chosen, the stresses might be slightly off the yield surface; however, on vector computers a much more efficient solution is achieved.
TOFF	Tension Cut Off, $TOFF < 0$ (positive in compression).

**Remarks:**

The implementation of an extended two invariant cap model, suggested by Stojko [1990], is based on the formulations of Simo, et al. [1988, 1990] and Sandler and Rubin [1979]. In this

model, the two invariant cap theory is extended to include nonlinear kinematic hardening as suggested by Isenberg, Vaughan, and Sandler [1978]. A brief discussion of the extended cap model and its parameters is given below.

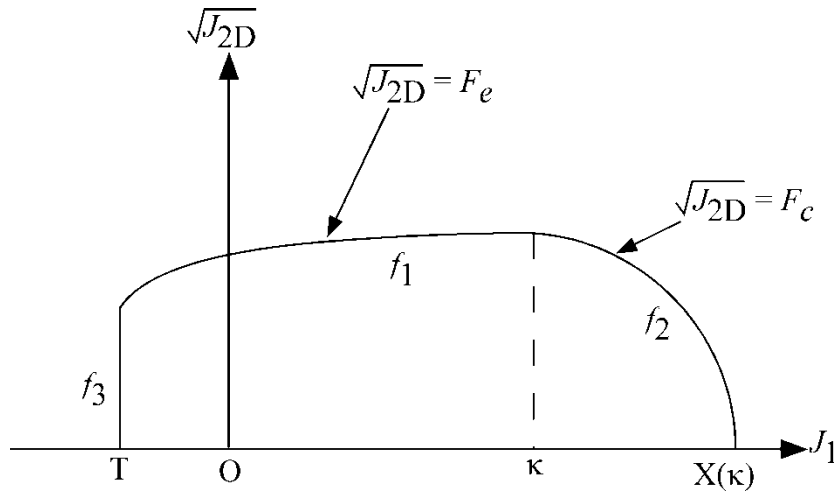

**Figure 25.1.** The yield surface of the two-invariant cap model in pressure  $\sqrt{J_{2D}} - J_1$  space. Surface  $f_1$  is the failure envelope,  $f_2$  is the cap surface, and  $f_3$  is the tension cutoff.

The cap model is formulated in terms of the invariants of the stress tensor. The square root of the second invariant of the deviatoric stress tensor,  $\sqrt{J_{2D}}$  is found from the deviatoric stresses  $s$  as

$$\sqrt{J_{2D}} \equiv \sqrt{\frac{1}{2} S_{ij} S_{ij}}$$

and is the objective scalar measure of the distortional or shearing stress. The first invariant of the stress,  $J_1$ , is the trace of the stress tensor.

The cap model consists of three surfaces in  $\sqrt{J_{2D}} - J_1$  space, as shown in Figure 25.1. First, there is a failure envelope surface, denoted  $f_1$  in the figure. The functional form of  $f_1$  is

$$f_1 = \sqrt{J_{2D}} - \min(F_e(J_1), T_{mises}) ,$$

where  $F_e$  is given by

$$F_e(J_1) \equiv \alpha - \gamma \exp(-\beta J_1) + \theta J_1$$

and  $T_{mises} \equiv |X(\kappa_n) - L(\kappa_n)|$ . This failure envelop surface is fixed in  $\sqrt{J_{2D}} - J_1$  space, and therefore does not harden unless kinematic hardening is present. Next, there is a cap surface, denoted  $f_2$  in the figure, with  $f_2$  given by

$$f_2 = \sqrt{J_{2D}} - F_c(J_1, K)$$

where  $F_c$  is defined by

$$F_c(J_1, \kappa) \equiv \frac{1}{R} \sqrt{[X(\kappa) - L(\kappa)]^2 - [J_1 - L(\kappa)]^2},$$

$X(\kappa)$  is the intersection of the cap surface with the  $J_1$  axis

$$X(\kappa) = \kappa + RF_e(\kappa),$$

and  $L(\kappa)$  is defined by

$$L(\kappa) \equiv \begin{cases} \kappa & \text{if } \kappa > 0 \\ 0 & \text{if } \kappa \leq 0 \end{cases}$$

The hardening parameter  $\kappa$  is related to the plastic volume change  $\varepsilon_v^p$  through the hardening law

$$\varepsilon_v^p = W \left\{ 1 - \exp[-D(X(\kappa) - X_0)] \right\}$$

Geometrically,  $\kappa$  is seen in the figure as the  $J_1$  coordinate of the intersection of the cap surface and the failure surface. Finally, there is the tension cutoff surface, denoted  $f_3$  in the figure. The function  $f_3$  is given by

$$f_3 \equiv T - J_1$$

where  $T$  is the input material parameter which specifies the maximum hydrostatic tension sustainable by the material. The elastic domain in  $\sqrt{J_{2D}} - J_1$  space is then bounded by the failure envelope surface above, the tension cutoff surface on the left, and the cap surface on the right.

An additive decomposition of the strain into elastic and plastic parts is assumed:

$$\boldsymbol{\varepsilon} = \boldsymbol{\varepsilon}^e + \boldsymbol{\varepsilon}^p,$$

where  $\boldsymbol{\varepsilon}^e$  is the elastic strain and  $\boldsymbol{\varepsilon}^p$  is the plastic strain. Stress is found from the elastic strain using Hooke's law,

$$\boldsymbol{\sigma} = \mathbf{C}(\boldsymbol{\varepsilon} - \boldsymbol{\varepsilon}^p),$$

where  $\boldsymbol{\sigma}$  is the stress and  $\mathbf{C}$  is the elastic constitutive tensor.

The yield condition may be written

$$f_1(s) \leq 0$$

$$f_2(s, \kappa) \leq 0$$

$$f_3(s) \leq 0$$

and the plastic consistency condition requires that

$$\begin{aligned} \dot{\lambda}_k f_k &= 0 \\ k &= 1, 2, 3 \\ \dot{\lambda}_k &\geq 0 \end{aligned}$$

where  $\lambda_k$  is the plastic consistency parameter for surface k. If  $f_k < 0$  then,  $\dot{\lambda}_k = 0$  and the response is elastic. If  $f_k > 0$  then surface k is active and  $\dot{\lambda}_k$  is found from the requirement that  $\dot{f}_k = 0$ .

Associated plastic flow is assumed, so using Koiter's flow rule the plastic strain rate is given as the sum of contribution from all of the active surfaces,

$$\dot{\epsilon}^p = \sum_{k=1}^3 \dot{\lambda}_k \frac{\partial f_k}{\partial s}$$

One of the major advantages of the cap model over other classical pressure-dependent plasticity models is the ability to control the amount of dilatancy produced under shear loading. Dilatancy is produced under shear loading as a result of the yield surface having a positive slope in  $\sqrt{J_{2D}} - J$  space, so the assumption of plastic flow in the direction normal to the yield surface produces a plastic strain rate vector that has a component in the volumetric (hydrostatic) direction (see Figure 25.1). In models such as the Drucker-Prager and Mohr-Coulomb, this dilatancy continues as long as shear loads are applied, and in many cases produces far more dilatancy than is experimentally observed in material tests. In the cap model, when the failure surface is active, dilatancy is produced just as with the Drucker-Prager and Mohr-Coulomb models. However, the hardening law permits the cap surface to contract until the cap intersects the failure envelope at the stress point, and the cap remains at that point. The local normal to the yield surface is now vertical, and therefore the normality rule assures that no further plastic volumetric strain (dilatancy) is created. Adjustment of the parameters that control the rate of cap contractions permits experimentally observed amounts of dilatancy to be incorporated into the cap model, thus producing a constitutive law which better represents the physics to be modeled.

Another advantage of the cap model over other models such as the Drucker-Prager and Mohr-Coulomb is the ability to model plastic compaction. In these models all purely volumetric response is elastic. In the cap model, volumetric response is elastic until the stress point hits the cap surface. Therefore, plastic volumetric strain (compaction) is generated at a rate controlled by the hardening law. Thus, in addition to controlling the amount of dilatancy, the introduction of the cap surface adds another experimentally observed response characteristic of geological material into the model.



The inclusion of kinematic hardening results in hysteretic energy dissipation under cyclic loading conditions. Following the approach of Isenberg, et al. [1978] a nonlinear kinematic hardening law is used for the failure envelope surface when nonzero values of  $\alpha$  and  $N$  are specified. In this case, the failure envelope surface is replaced by a family of yield surfaces bounded by an initial yield surface and a limiting failure envelope surface. Thus, the shape of the yield surfaces described above remains unchanged, but they may translate in a plane orthogonal to the  $J$  axis,

Translation of the yield surfaces is permitted through the introduction of a “back stress” tensor,  $\alpha$ . The formulation including kinematic hardening is obtained by replacing the stress  $\sigma$  with the translated stress tensor  $\eta \equiv \sigma - \alpha$  in all of the above equation. The history tensor  $\alpha$  is assumed deviatoric, and therefore has only 5 unique components. The evolution of the back stress tensor is governed by the nonlinear hardening law

$$\alpha = \bar{c}\bar{F}(\sigma, \alpha)\dot{\epsilon}^p$$

where  $\bar{c}$  is a constant,  $\bar{F}$  is a scalar function of  $\sigma$  and  $\alpha$  and  $\dot{\epsilon}^p$  is the rate of deviatoric plastic strain. The constant may be estimated from the slope of the shear stress - plastic shear strain curve at low levels of shear stress.

The function  $\bar{F}$  is defined as

$$\bar{F} \equiv \max\left(0, 1 - \frac{(\sigma - \alpha) \bullet \alpha}{2NF_e(J_1)}\right)$$

where  $N$  is a constant defining the size of the yield surface. The value of  $N$  may be interpreted as the radial distance between the outside of the initial yield surface and the inside of the limit surface. In order for the limit surface of the kinematic hardening cap model to correspond with the failure envelope surface of the standard cap model, the scalar parameter  $\alpha$  must be replaced  $\alpha - N$  in the definition  $F_e$ .

The cap model contains a number of parameters which must be chosen to represent a particular material, and are generally based on experimental data. The parameters  $\alpha$ ,  $\beta$ ,  $\theta$ , and  $\gamma$  are usually evaluated by fitting a curve through failure data taken from a set of triaxial compression tests. The parameters  $W$ ,  $D$ , and  $X_0$  define the cap hardening law. The value  $W$  represents the void fraction of the uncompressed sample and  $D$  governs the slope of the initial loading curve in hydrostatic compression. The value of  $R$  is the ration of major to minor axes of the quarter ellipse defining the cap surface. Additional details and guidelines for fitting the cap model to experimental data are found in Chen and Baladi [1985].

**\*MAT\_HONEYCOMB**

This is Material Type 26. The major use of this material model is for honeycomb and foam materials with real anisotropic behavior. A nonlinear elastoplastic material behavior can be defined separately for all normal and shear stresses. These are considered to be fully uncoupled. See notes below.

Card 1            1            2            3            4            5            6            7            8

Variable	MID	RO	E	PR	SIGY	VF	MU	BULK
Type	A8	F	F	F	F	F	F	F
Default	none	none	none	none	none	none	.05	0.0

Card 2            1            2            3            4            5            6            7            8

Variable	LCA	LCB	LCC	LCS	LCAB	LCBC	LCCA	LCSR
Type	F	F	F	F	F	F	F	F
Default	none	LCA	LCA	LCA	LCS	LCS	LCS	optional

Card 3            1            2            3            4            5            6            7            8

Variable	EAAU	EBBU	ECCU	GABU	GBCU	GCAU	AOPT	MACF
Type	F	F	F	F	F	F		I

Card 4            1            2            3            4            5            6            7            8

Variable	XP	YP	ZP	A1	A2	A3		
Type	F	F	F	F	F	F		

Card 5            1            2            3            4            5            6            7            8

Variable	D1	D2	D3	TSEF	SSEF	V1	V2	V3
Type	F	F	F	F	F	F	F	F

<u>VARIABLE</u>	<u>DESCRIPTION</u>
MID	Material identification. A unique number or label not exceeding 8 characters must be specified.
RO	Mass density.
E	Young's modulus for compacted honeycomb material.
PR	Poisson's ratio for compacted honeycomb material.
SIGY	Yield stress for fully compacted honeycomb.
VF	Relative volume at which the honeycomb is fully compacted.
MU	$\mu$ , material viscosity coefficient. (default=.05) Recommended.
BULK	Bulk viscosity flag: EQ.0.0: bulk viscosity is not used. This is recommended. EQ.1.0: bulk viscosity is active and $\mu=0$ . This will give results identical to previous versions of LS-DYNA.
LCA	Load curve ID, see *DEFINE_CURVE, for sigma-aa versus either relative volume or volumetric strain. See notes below.
LCB	Load curve ID, see *DEFINE_CURVE, for sigma-bb versus either relative volume or volumetric strain. Default LCB=LCA. See notes below.
LCC	Load curve ID, see *DEFINE_CURVE, for sigma-cc versus either relative volume or volumetric strain. Default LCC=LCA. See notes below.
LCS	Load curve ID, see *DEFINE_CURVE, for shear stress versus either relative volume or volumetric strain. Default LCS=LCA. Each component of shear stress may have its own load curve. See notes below.

<b>VARIABLE</b>	<b>DESCRIPTION</b>
LCAB	Load curve ID, see *DEFINE_CURVE, for sigma-ab versus either relative volume or volumetric strain. Default LCAB=LCS. See notes below.
LCBC	Load curve ID, see *DEFINE_CURVE, for sigma-bc versus either relative volume or volumetric strain. Default LCBC=LCS. See notes below.
LCCA	Load curve ID, see *DEFINE_CURVE, or sigma-ca versus either relative volume or volumetric strain. Default LCCA=LCS. See notes below.
LCSR	Load curve ID, see *DEFINE_CURVE, for strain-rate effects defining the scale factor versus strain rate. This is optional. The curves defined above are scaled using this curve.
EAAU	Elastic modulus $E_{aaU}$ in uncompressed configuration.
EBBU	Elastic modulus $E_{bbU}$ in uncompressed configuration.
ECCU	Elastic modulus $E_{ccU}$ in uncompressed configuration.
GABU	Shear modulus $G_{abU}$ in uncompressed configuration.
GBCU	Shear modulus $G_{bcU}$ in uncompressed configuration.
GCAU	Shear modulus $G_{caU}$ in uncompressed configuration.

VARIABLE	DESCRIPTION
AOPT	<p>Material axes option (see MAT_OPTION TROPIC_ELASTIC for a more complete description):</p> <p>EQ.0.0: locally orthotropic with material axes determined by element nodes 1, 2, and 4, as with *DEFINE_COORDINATE_NODES.</p> <p>EQ.1.0: locally orthotropic with material axes determined by a point in space and the global location of the element center; this is the a-direction.</p> <p>EQ.2.0: globally orthotropic with material axes determined by vectors defined below, as with *DEFINE_COORDINATE_VECTOR</p> <p>EQ.3.0: locally orthotropic material axes determined by rotating the material axes about the element normal by an angle, BETA, from a line in the plane of the element defined by the cross product of the vector <b>v</b> with the element normal. The plane of a solid element is the midsurface between the inner surface and outer surface defined by the first four nodes and the last four nodes of the connectivity of the element, respectively.</p> <p>EQ.4.0: locally orthotropic in cylindrical coordinate system with the material axes determined by a vector <b>v</b>, and an originating point, <b>P</b>, which define the centerline axis. This option is for solid elements only.</p> <p>LT.0.0: the absolute value of AOPT is a coordinate system ID number (CID on *DEFINE_COORDINATE_NODES, *DEFINE_COORDINATE_SYSTEM or *DEFINE_COORDINATE_VECTOR). Available in R3 version of 971 and later..</p>
MACF	<p>Material axes change flag:</p> <p>EQ.1: No change, default,</p> <p>EQ.2: switch material axes a and b,</p> <p>EQ.3: switch material axes a and c,</p> <p>EQ.4: switch material axes b and c.</p>
XP YP ZP	Coordinates of point <b>p</b> for AOPT = 1.
A1 A2 A3	Components of vector <b>a</b> for AOPT = 2.
D1 D2 D3	Components of vector <b>d</b> for AOPT = 2.
V1 V2 V3	Define components of vector <b>v</b> for AOPT = 3 and 4.
TSEF	Tensile strain at element failure (element will erode).
SSEF	Shear strain at element failure (element will erode).

**Remarks:**

For efficiency it is strongly recommended that the load curve ID's: LCA, LCB, LCC, LCS, LCAB, LCBC, and LCCA, contain exactly the same number of points with corresponding strain values on the abscissa. If this recommendation is followed the cost of the table lookup is insignificant. Conversely, the cost increases significantly if the abscissa strain values are not consistent between load curves.

The behavior before compaction is orthotropic where the components of the stress tensor are uncoupled, i.e., an *a* component of strain will generate resistance in the local *a*-direction with no coupling to the local *b* and *c* directions. The elastic moduli vary, from their initial values to the fully compacted values at  $V_f$ , linearly with the relative volume *V*:

$$E_{aa} = E_{aa0} + \beta(E - E_{aa0})$$

$$E_{bb} = E_{bb0} + \beta(E - E_{bb0})$$

$$E_{cc} = E_{cc0} + \beta(E - E_{cc0})$$

$$G_{ab} = G_{ab0} + \beta(G - G_{ab0})$$

$$G_{bc} = G_{bc0} + \beta(G - G_{bc0})$$

$$G_{ca} = G_{ca0} + \beta(G - G_{ca0})$$

where

$$\beta = \max \left[ \min \left( \frac{1-V}{1-V_f}, 1 \right), 0 \right]$$

and *G* is the elastic shear modulus for the fully compacted honeycomb material

$$G = \frac{E}{2(1+\nu)}$$

The relative volume, *V*, is defined as the ratio of the current volume to the initial volume. Typically, *V*=1 at the beginning of a calculation. The viscosity coefficient  $\mu$  (MU) should be set to a small number (usually .02-.10 is okay). Alternatively, the two bulk viscosity coefficients on the control cards should be set to very small numbers to prevent the development of spurious pressures that may lead to undesirable and confusing results. The latter is not recommended since spurious numerical noise may develop.

The load curves define the magnitude of the average stress as the material changes density (relative volume), see Figure 26.1. Each curve related to this model must have the same number of points and the same abscissa values. There are two ways to define these curves, **a**) as a function of relative volume (*V*) or **b**) as a function of volumetric strain defined as:

$$\varepsilon_V = 1 - V$$

In the former, the first value in the curve should correspond to a value of relative volume slightly less than the fully compacted value. In the latter, the first value in the curve should be less than or equal to zero, corresponding to tension, and increase to full compaction. **Care should be taken when defining the curves so that extrapolated values do not lead to negative yield stresses.**

At the beginning of the stress update each element's stresses and strain rates are transformed into the local element coordinate system. For the uncompacted material, the trial stress components are updated using the elastic interpolated moduli according to:

$$\sigma_{aa}^{n+1^{trial}} = \sigma_{aa}^n + E_{aa} \Delta \varepsilon_{aa}$$

$$\sigma_{bb}^{n+1^{trial}} = \sigma_{bb}^n + E_{bb} \Delta \varepsilon_{bb}$$

$$\sigma_{cc}^{n+1^{trial}} = \sigma_{cc}^n + E_{cc} \Delta \varepsilon_{cc}$$

$$\sigma_{ab}^{n+1^{trial}} = \sigma_{ab}^n + 2G_{ab} \Delta \varepsilon_{ab}$$

$$\sigma_{bc}^{n+1^{trial}} = \sigma_{bc}^n + 2G_{bc} \Delta \varepsilon_{bc}$$

$$\sigma_{ca}^{n+1^{trial}} = \sigma_{ca}^n + 2G_{ca} \Delta \varepsilon_{ca}$$

Each component of the updated stresses is then independently checked to ensure that they do not exceed the permissible values determined from the load curves; e.g., if

$$\left| \sigma_{ij}^{n+1^{trial}} \right| > \lambda \sigma_{ij}(V)$$

then

$$\sigma_{ij}^{n+1} = \sigma_{ij}(V) \frac{\lambda \sigma_{ij}^{n+1^{trial}}}{\left| \lambda \sigma_{ij}^{n+1^{trial}} \right|}$$

On Card 2  $\sigma_{ij}(V)$  is defined by LCA for the aa stress component, LCB for the bb component, LCC for the cc component, and LCS for the ab, bc, ca shear stress components. The parameter  $\lambda$  is either unity or a value taken from the load curve number, LCSR, that defines  $\lambda$  as a function of strain-rate. Strain-rate is defined here as the Euclidean norm of the deviatoric strain-rate tensor.

For fully compacted material it is assumed that the material behavior is elastic-perfectly plastic and the stress components updated according to:

$$s_{ij}^{trial} = s_{ij}^n + 2G \Delta \varepsilon_{ij}^{dev \, n+1/2}$$

where the deviatoric strain increment is defined as

$$\Delta \varepsilon_{ij}^{dev} = \Delta \varepsilon_{ij} - \frac{1}{3} \Delta \varepsilon_{kk} \delta_{ij}$$

Now a check is made to see if the yield stress for the fully compacted material is exceeded by comparing

$$s_{eff}^{trial} = \left( \frac{3}{2} s_{ij}^{trial} s_{ij}^{trial} \right)^{1/2}$$

the effective trial stress to the defined yield stress, SIGY. If the effective trial stress exceeds the yield stress the stress components are simply scaled back to the yield surface

$$s_{ij}^{n+1} = \frac{\sigma_y}{s_{eff}^{trial}} s_{ij}^{trial}$$

Now the pressure is updated using the elastic bulk modulus, K

$$p^{n+1} = p^n - K \Delta \varepsilon_{kk}^{n+1/2}$$
$$K = \frac{E}{3(1-2\nu)}$$

to obtain the final value for the Cauchy stress

$$\sigma_{ij}^{n+1} = s_{ij}^{n+1} - p^{n+1} \delta_{ij}$$

After completing the stress update transform the stresses back to the global configuration.



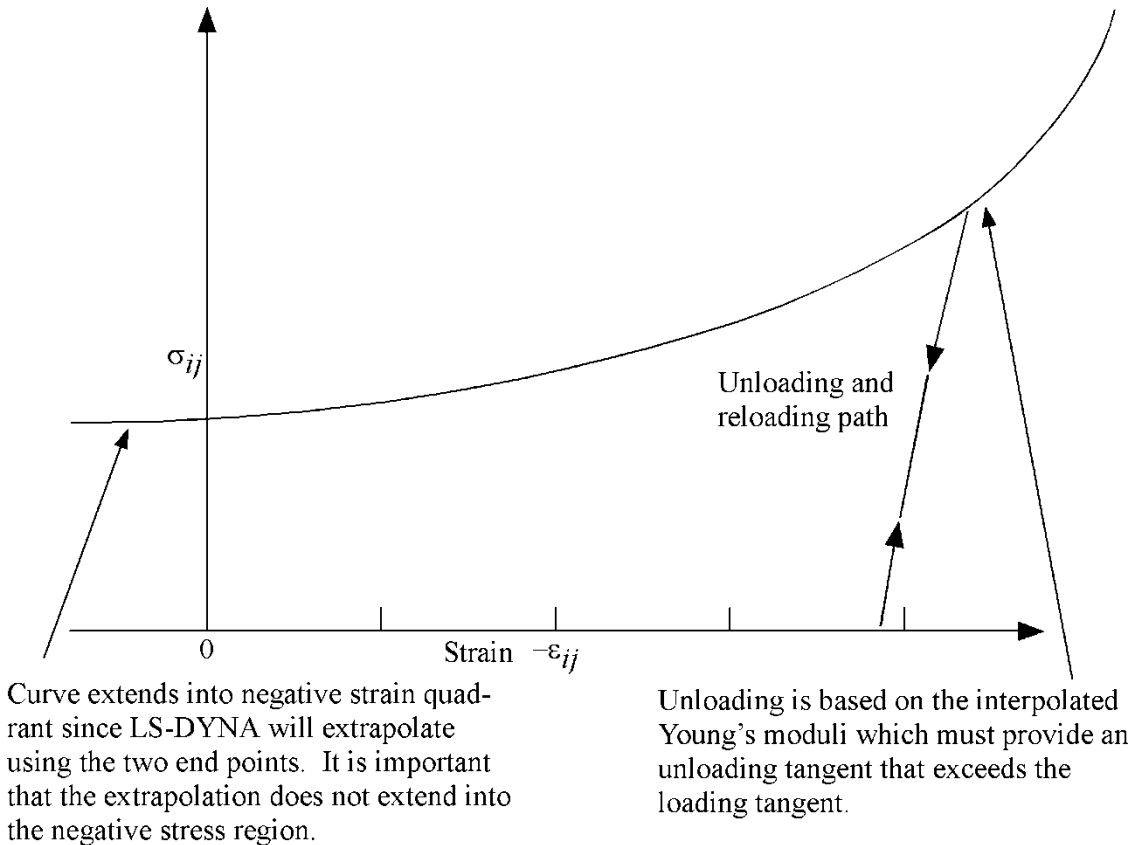

**Figure 26.1.** Stress quantity versus volumetric strain. Note that the “yield stress” at a volumetric strain of zero is non-zero. In the load curve definition, see \*DEFINE\_CURVE, the “time” value is the volumetric strain and the “function” value is the yield stress.

**\*MAT\_MOONEY-RIVLIN\_RUBBER**

This is Material Type 27. A two-parametric material model for rubber can be defined.

Card 1            1            2            3            4            5            6            7            8

Variable	MID	RO	PR	A	B	REF		
Type	A8	F	F	F	F	F		

Card 2            1            2            3            4            5            6            7            8

Variable	SGL	SW	ST	LCID				
Type	F	F	F	F				

<u>VARIABLE</u>	<u>DESCRIPTION</u>
MID	Material identification. A unique number or label not exceeding 8 characters must be specified.
RO	Mass density.
PR	Poisson's ratio (value between 0.49 and 0.5 is recommended, smaller values may not work).
A	Constant, see literature and equations defined below.
B	Constant, see literature and equations defined below.
REF	Use reference geometry to initialize the stress tensor. The reference geometry is defined by the keyword:*INITIAL_FOAM_REFERENCE_GEOMETRY (see there for more details). EQ.0.0: off, EQ.1.0: on.

If A=B=0.0, then a least square fit is computed from tabulated uniaxial data via a load curve. The following information should be defined

SGL	Specimen gauge length $l_0$ , see Figure 27.1.
SW	Specimen width, see Figure 27.1.

VARIABLE	DESCRIPTION
ST	Specimen thickness, see Figure 27.1.
LCID	Load curve ID, see *DEFINE_CURVE, giving the force versus actual change $\Delta L$ in the gauge length. See also Figure 27.2 for an alternative definition.

**Remarks:**

The strain energy density function is defined as:

$$W = A(I - 3) + B(II - 3) + C(III^{-2} - 1) + D(III - 1)^2$$

where

$$C = 0.5 A + B$$

$$D = \frac{A(5\nu - 2) + B(11\nu - 5)}{2(1 - 2\nu)}$$

$\nu$  = Poisson's ratio

$2(A+B)$  = shear modulus of linear elasticity

I, II, III = invariants of right Cauchy-Green Tensor  $C$ .

The load curve definition that provides the uniaxial data should give the change in gauge length,  $\Delta L$ , versus the corresponding force. In compression both the force and the change in gauge length must be specified as negative values. In tension the force and change in gauge length should be input as positive values. The principal stretch ratio in the uniaxial direction,  $\lambda_1$ , is then given by

$$\lambda_1 = \frac{L_0 + \Delta L}{L_0}$$

with  $L_0$  being the initial length and  $L$  being the actual length.

Alternatively, the stress versus strain curve can also be input by setting the gauge length, thickness, and width to unity (1.0) and defining the engineering strain in place of the change in gauge length and the nominal (engineering) stress in place of the force, see Figure 27.2.

The least square fit to the experimental data is performed during the initialization phase and is a comparison between the fit and the actual input is provided in the d3hsp file. It is a good idea to visually check to make sure it is acceptable. The coefficients A and B are also printed in the

output file. It is also advised to use the material driver (see Appendix K) for checking out the material model.

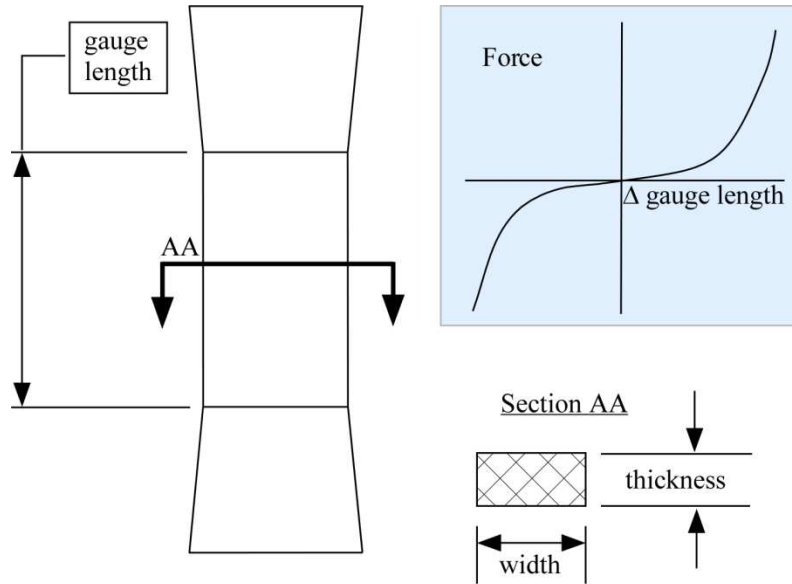

Figure 27.1. Uniaxial specimen for experimental data.

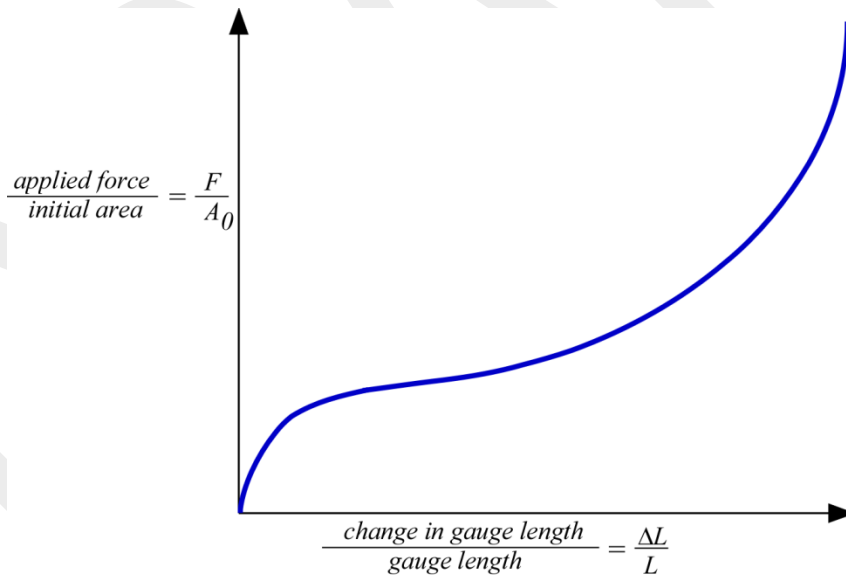

Figure 27.2. The stress versus strain curve can be used instead of the force versus the change in the gauge length by setting the gauge length, thickness, and width to unity (1.0) and defining the engineering strain in place of the change in gauge length and the nominal (engineering) stress in place of the force. \*MAT\_077\_O is a better alternative for fitting data resembling the curve above. \*MAT\_027 will provide a poor fit to a curve that exhibits an strong upturn in slope as strains become large.

\*MAT\_RESULTANT\_PLASTICITY

This is Material Type 28. A resultant formulation for beam and shell elements including elasto-plastic behavior can be defined. This model is available for the Belytschko-Schwer beam, the C<sup>0</sup> triangular shell, the Belytschko-Tsay shell, and the fully integrated type 16 shell. For beams, the treatment is elastic-perfectly plastic, but for shell elements isotropic hardening is approximately modeled. For a detailed description we refer to the LS-DYNA Theory Manual. Since the stresses are not computed in the resultant formulation, the stresses output to the binary databases for the resultant elements are zero.

Card 1            1            2            3            4            5            6            7            8

Variable	MID	RO	E	PR	SIGY	ETAN		
Type	A8	F	F	F	F	F		
Default	none	none	none	none	none	0.0		

VARIABLE

DESCRIPTION

MID	Material identification. A unique number or label not exceeding 8 characters must be specified.
RO	Mass density
E	Young's modulus
PR	Poisson's ratio
SIGY	Yield stress
ETAN	Plastic hardening modulus (for shells only)

**\*MAT\_FORCE\_LIMITED**

This is Material Type 29. With this material model, for the Belytschko-Schwer beam only, plastic hinge forming at the ends of a beam can be modeled using curve definitions. Optionally, collapse can also be modeled. See also \*MAT\_139.

Description: FORCE LIMITED Resultant Formulation

Card 1            1            2            3            4            5            6            7            8

Variable	MID	RO	E	PR	DF	AOPT	YTFLAG	ASOFT
Type	A8	F	F	F	F	F	F	F
Default	none	none	none	none	0.0	0.0	0.0	0.0

Card 2            1            2            3            4            5            6            7            8

Variable	M1	M2	M3	M4	M5	M6	M7	M8
Type	F	F	F	F	F	F	F	F
Default	none	0	0	0	0	0	0	0

Card 3            1            2            3            4            5            6            7            8

Variable	LC1	LC2	LC3	LC4	LC5	LC6	LC7	LC8
Type	F	F	F	F	F	F	F	F
Default	none	0	0	0	0	0	0	0

Card 4            1            2            3            4            5            6            7            8

Variable	LPS1	SFS1	LPS2	SFS2	YMS1	YMS2		
Type	F	F	F	F	F	F		
Default	0	1.0	LPS1	1.0	1.0E+20	YMS1		

Card 5            1            2            3            4            5            6            7            8

Variable	LPT1	SFT1	LPT2	SFT2	YMT1	YMT2		
Type	F	F	F	F	F	F		
Default	0	1.0	LPT1	1.0	1.0E+20	YMT1		

Card 6            1            2            3            4            5            6            7            8

Variable	LPR	SFR	YMR					
Type	F	F	F					
Default	0	1.0	1.0E+20					

**VARIABLE**

**DESCRIPTION**

- MID            Material identification. A unique number or label not exceeding 8 characters must be specified.
- RO            Mass density
- E            Young's modulus
- PR            Poisson's ratio
- DF            Damping factor, see definition in notes below. A proper control for the timestep has to be maintained by the user!

<u>VARIABLE</u>	<u>DESCRIPTION</u>
AOPT	Axial load curve option: EQ.0.0: axial load curves are force versus strain, EQ.1.0: axial load curves are force versus change in length. LT.0.0: the absolute value of AOPT is a coordinate system ID number (CID on *DEFINE_COORDINATE_NODES, *DEFINE_COORDINATE_SYSTEM or *DEFINE_COORDINATE_VECTOR). Available in R3 version of 971 and later.
YTFLAG	Flag to allow beam to yield in tension: EQ.0.0: beam does not yield in tension, EQ.1.0: beam can yield in tension.
ASOFT	Axial elastic softening factor applied once hinge has formed. When a hinge has formed the stiffness is reduced by this factor. If zero, this factor is ignored.
M1, M2,...,M8	Applied end moment for force versus (strain/change in length) curve. At least one must be defined. A maximum of 8 moments can be defined. The values should be in ascending order.
LC1, LC2,...,LC8	Load curve ID (see *DEFINE_CURVE) defining axial force (collapse load) versus strain/change in length (see AOPT) for the corresponding applied end moment. Define the same number as end moments. Each curve must contain the same number of points.
LPS1	Load curve ID for plastic moment versus rotation about s-axis at node 1. If zero, this load curve is ignored.
SFS1	Scale factor for plastic moment versus rotation curve about s-axis at node 1. Default = 1.0.
LPS2	Load curve ID for plastic moment versus rotation about s-axis at node 2. Default: is same as at node 1.
SFS2	Scale factor for plastic moment versus rotation curve about s-axis at node 2. Default: is same as at node 1.
YMS1	Yield moment about s-axis at node 1 for interaction calculations (default set to 1.0E+20 to prevent interaction).
YMS2	Yield moment about s-axis at node 2 for interaction calculations (default set to YMS1).
lpt1	Load curve ID for plastic moment versus rotation about t-axis at node 1. If zero, this load curve is ignored.



<u>VARIABLE</u>	<u>DESCRIPTION</u>
sft1	Scale factor for plastic moment versus rotation curve about t-axis at node 1. Default = 1.0.
lpt2	Load curve ID for plastic moment versus rotation about t-axis at node 2. Default: is the same as at node 1.
sf2	Scale factor for plastic moment versus rotation curve about t-axis at node 2. Default: is the same as at node 1.
YMT1	Yield moment about t-axis at node 1 for interaction calculations (default set to 1.0E+20 to prevent interactions)
YMT2	Yield moment about t-axis at node 2 for interaction calculations (default set to YMT1)
LPR	Load curve ID for plastic torsional moment versus rotation. If zero, this load curve is ignored.
SFR	Scale factor for plastic torsional moment versus rotation (default = 1.0).
YMR	Torsional yield moment for interaction calculations (default set to 1.0E+20 to prevent interaction)

**Remarks:**

This material model is available for the Belytschko resultant beam element only. Plastic hinges form at the ends of the beam when the moment reaches the plastic moment. The moment versus rotation relationship is specified by the user in the form of a load curve and scale factor. The points of the load curve are (plastic rotation in radians, plastic moment). Both quantities should be positive for all points, with the first point being (zero, initial plastic moment). Within this constraint any form of characteristic may be used, including flat or falling curves. Different load curves and scale factors may be specified at each node and about each of the local s and t axes.

Axial collapse occurs when the compressive axial load reaches the collapse load. Collapse load versus collapse deflection is specified in the form of a load curve. The points of the load curve are either (true strain, collapse force) or (change in length, collapse force). Both quantities should be entered as positive for all points, and will be interpreted as compressive. The first point should be (zero, initial collapse load).

The collapse load may vary with end moment as well as with deflections. In this case several load-deflection curves are defined, each corresponding to a different end moment. Each load curve should have the same number of points and the same deflection values. The end moment is defined as the average of the absolute moments at each end of the beam and is always positive.

Stiffness-proportional damping may be added using the damping factor  $\lambda$ . This is defined as follows:

$$\lambda = \frac{2 * \xi}{\omega}$$

where  $\xi$  is the damping factor at the reference frequency  $\omega$  (in radians per second). For example if 1% damping at 2Hz is required

$$\lambda = \frac{2 * 0.01}{2\pi * 2} = 0.001592$$

If damping is used, a small timestep may be required. LS-DYNA does not check this so to avoid instability it may be necessary to control the timestep via a load curve. As a guide, the timestep required for any given element is multiplied by  $0.3L/c\lambda$  when damping is present (L = element length, c = sound speed).

**Moment Interaction:**

Plastic hinges can form due to the combined action of moments about the three axes. This facility is activated only when yield moments are defined in the material input. A hinge forms when the following condition is first satisfied.

$$\left(\frac{M_r}{M_{ryield}}\right)^2 + \left(\frac{M_s}{M_{syield}}\right)^2 + \left(\frac{M_t}{M_{tyield}}\right)^2 \geq 1$$

where,

$M_r, M_s, M_t$  = current moment

$M_{ryield}, M_{syield}, M_{tyield}$  = yield moment

Note that scale factors for hinge behavior defined in the input will also be applied to the yield moments: for example,  $M_{syield}$  in the above formula is given by the input yield moment about the local axis times the input scale factor for the local s axis. For strain-softening characteristics, the yield moment should generally be set equal to the initial peak of the moment-rotation load curve.

On forming a hinge, upper limit moments are set. These are given by

$$M_{rupper} = MAX\left(M_r, \frac{M_{ryield}}{2}\right)$$

and similar for  $M_s$  and  $M_t$ .

Thereafter the plastic moments will be given by

$$M_{rp} = \min(M_{rupper}, M_{rcurve}) \text{ and similar for s and t}$$

where

$M_{rp}$  = current plastic moment

$M_{rcurve}$  = moment taken from load curve at the current rotation scaled according to the scale factor.

The effect of this is to provide an upper limit to the moment that can be generated; it represents the softening effect of local buckling at a hinge site. Thus if a member is bent about its local s-axis it will then be weaker in torsion and about its local t-axis. For moments-softening curves, the effect is to trim off the initial peak (although if the curves subsequently harden, the final hardening will also be trimmed off).

It is not possible to make the plastic moment vary with axial load.

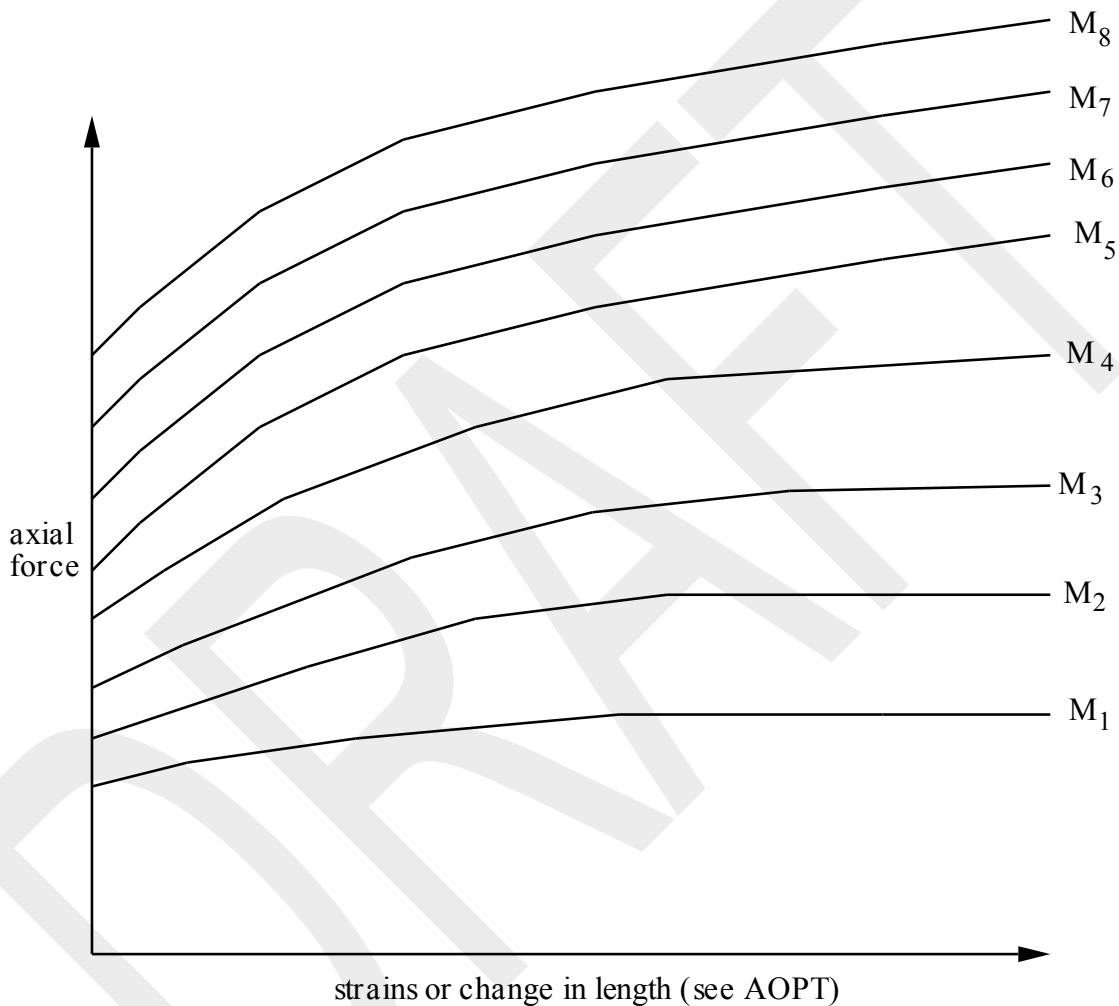

**Figure 29.1.** The force magnitude is limited by the applied end moment. For an intermediate value of the end moment LS-DYNA interpolates between the curves to determine the allowable force value.

**\*MAT\_SHAPE\_MEMORY**

This is material type 30. This material model describes the superelastic response present in shape-memory alloys (SMA), that is the peculiar material ability to undergo large deformations with a full recovery in loading-unloading cycles (See Figure 30.1). The material response is always characterized by a hysteresis loop. See the references by Auricchio, Taylor and Lubliner [1997] and Auricchio and Taylor [1997]. This model is available for shell and solid elements. For Hughes-Liu beam elements it is available starting in Release 3 of version 971.

Card 1            1            2            3            4            5            6            7            8

Variable	MID	RO	E	PR				
Type	A8	F	F	F				
Default	none	none	none	none				

Card 2            1            2            3            4            5            6            7            8

Variable	SIG_ASS	SIG_ASF	SIG_SAS	SIG_SAF	EPSL	ALPHA	YMRT	
Type	F	F	F	F	F	F	F	
Default	none	none	none	none	none	0.0	0.0	

<u>VARIABLE</u>	<u>DESCRIPTION</u>
MID	Material identification. A unique number or label not exceeding 8 characters must be specified.
RO	Density
E	Young's modulus
PR	Poisson's ratio
SIG_ASS	Starting value for the forward phase transformation (conversion of austenite into martensite) in the case of a uniaxial tensile state of stress. A load curve for SIG_ASS as a function of temperature is specified by using the negative of the load curve ID number.

VARIABLE	DESCRIPTION
SIG_ASF	Final value for the forward phase transformation (conversion of austenite into martensite) in the case of a uniaxial tensile state of stress. SIG_ASF as a function of temperature is specified by using the negative of the load curve ID number.
SIG_SAS	Starting value for the reverse phase transformation (conversion of martensite into austenite) in the case of a uniaxial tensile state of stress. SIG_SAS as a function of temperature is specified by using the negative of the load curve ID number.
SIG_SAF	Final value for the reverse phase transformation (conversion of martensite into austenite) in the case of a uniaxial tensile state of stress. SIG_SAF as a function of temperature is specified by using the negative of the load curve ID number.
EPSL	Recoverable strain or maximum residual strain. It is a measure of the maximum deformation obtainable all the martensite in one direction.
ALPHA	Parameter measuring the difference between material responses in tension and compression (set alpha = 0 for no difference). Also, see the following Remark.
YMRT	Young's modulus for the martensite if it is different from the modulus for the austenite. Defaults to the austenite modulus if it is set to zero.

### **Remarks:**

The material parameter alpha,  $\alpha$ , measures the difference between material responses in tension and compression. In particular, it is possible to relate the parameter  $\alpha$  to the initial stress value of the austenite into martensite conversion, indicated respectively as  $\sigma_s^{AS,+}$  and  $\sigma_s^{AS,-}$ , according to the following expression:

$$\alpha = \frac{\sigma_s^{AS,-} - \sigma_s^{AS,+}}{\sigma_s^{AS,-} + \sigma_s^{AS,+}}$$

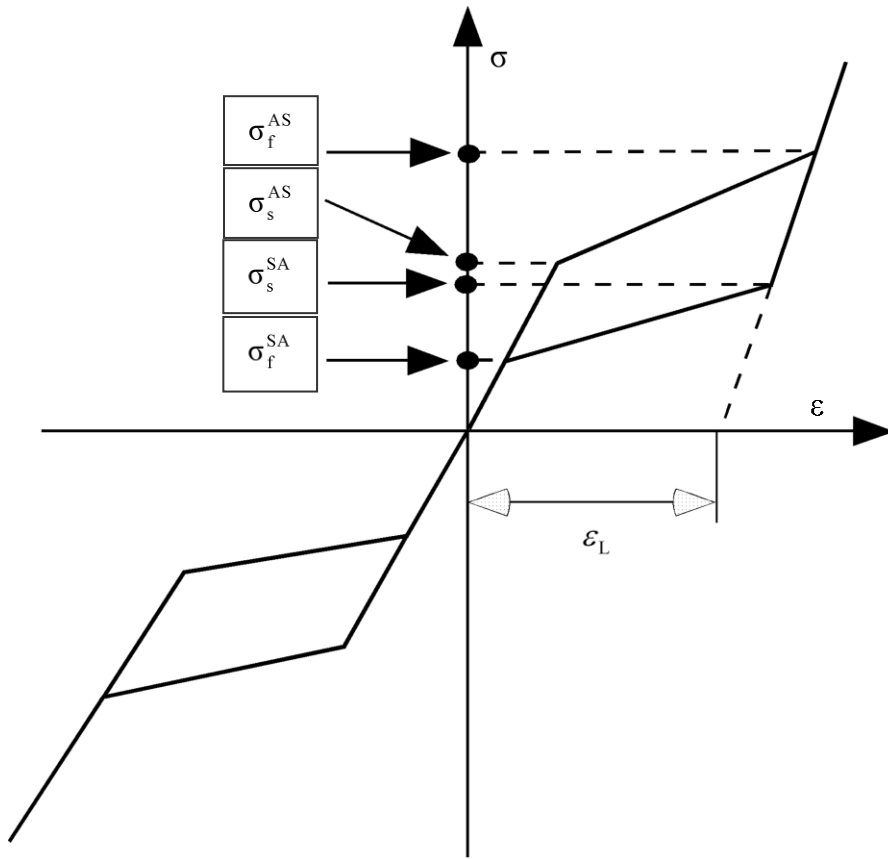

**Figure 30.1.** Pictorial representation of superelastic behavior for a shape-memory material.

In the following, the results obtained from a simple test problem is reported. The material properties are set as:

E	60000 MPa
Nu	0.3
sig_AS_s	520 MPa
sig_AS_f	600 MPa
sig_SA_s	300 MPa
sig_SA_f	200 MPa
epsL	0.07
alpha	0.12
ymrt	50000 MPa

The investigated problem is the complete loading-unloading test in tension and compression. The uniaxial Cauchy stress versus the logarithmic strain is plotted in Figure 30.2.

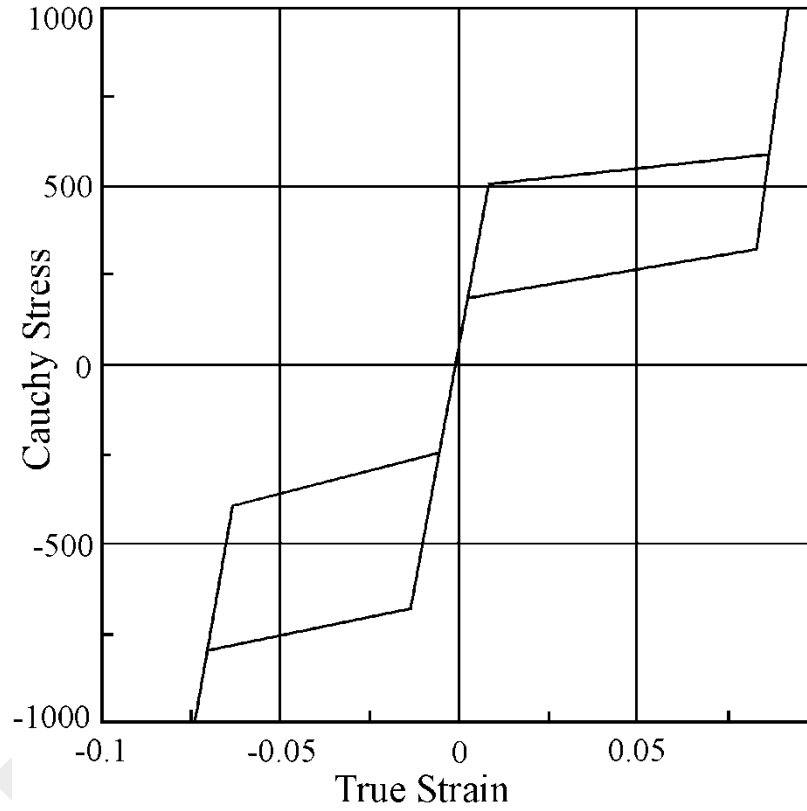

Figure 30.2. Complete loading-unloading test in tension and compression

**\*MAT\_FRAZER\_NASH\_RUBBER\_MODEL**

This is Material Type 31. This model defines rubber from uniaxial test data. It is a modified form of the hyperelastic constitutive law first described in Kenchington [1988]. See also the notes below.

Card 1            1            2            3            4            5            6            7            8

Variable	MID	RO	PR	C100	C200	C300	C400	
Type	A8	F	F	F	F	F	F	

Card 2            1            2            3            4            5            6            7            8

Variable	C110	C210	C010	C020	EXIT	EMAX	EMIN	REF
Type	F	F	F	F	F	F	F	F

Card 3            1            2            3            4            5            6            7            8

Variable	SGL	SW	ST	LCID				
Type	F	F	F	F				

<u>VARIABLE</u>	<u>DESCRIPTION</u>
MID	Material identification. A unique number or label not exceeding 8 characters must be specified.
RO	Mass density.
PR	Poisson's ratio. Values between .49 and .50 are suggested.
C100	C <sub>100</sub> (EQ.1.0 if term is in the least squares fit.)
C200	C <sub>200</sub> (EQ.1.0 if term is in the least squares fit.)
C300	C <sub>300</sub> (EQ.1.0 if term is in the least squares fit.)



<u>VARIABLE</u>	<u>DESCRIPTION</u>
C400	C <sub>400</sub> (EQ.1.0 if term is in the least squares fit.)
C110	C <sub>110</sub> (EQ.1.0 if term is in the least squares fit.)
C210	C <sub>210</sub> (EQ.1.0 if term is in the least squares fit.)
C010	C <sub>010</sub> (EQ.1.0 if term is in the least squares fit.)
C020	C <sub>020</sub> (EQ.1.0 if term is in the least squares fit.)
EXIT	Exit option: EQ.0.0: stop if strain limits are exceeded (recommended), NE.0.0: continue if strain limits are exceeded. The curve is then extrapolated.
EMAX	Maximum strain limit, (Green-St, Venant Strain).
EMIN	Minimum strain limit, (Green-St, Venant Strain).
REF	Use reference geometry to initialize the stress tensor. The reference geometry is defined by the keyword: *INITIAL_FOAM_REFERENCE_GEOMETRY (see there for more details). EQ.0.0: off, EQ.1.0: on.
SGL	Specimen gauge length, see Figure 27.1.
SW	Specimen width, see Figure 27.1.
ST	Specimen thickness, see Figure 27.1.
LCID	Load curve ID, see DEFINE_CURVE, giving the force versus actual change in gauge length. See also Figure 27.2 for an alternative definition.

**Remarks:**

The constants can be defined directly or a least squares fit can be performed if the uniaxial data (SGL, SW, ST and LCID) is available. If a least squares fit is chosen, then the terms to be included in the energy functional are flagged by setting their corresponding coefficients to unity. If all coefficients are zero the default is to use only the terms involving  $I_1$  and  $I_2$ .  $C_{100}$  defaults to unity if the least square fit is used.

The strain energy functional,  $U$ , is defined in terms of the input constants as:

$$U = C_{100}I_1 + C_{200}I_1^2 + C_{300}I_1^3 + C_{400}I_1^4 + C_{110}I_1I_2 + C_{210}I_1^2I_2 + C_{010}I_2 + C_{020}I_2^2 + f(J)$$

where the invariants can be expressed in terms of the deformation gradient matrix,  $F_{ij}$ , and the Green-St. Venant strain tensor,  $E_{ij}$  :

$$J = |F_{ij}|$$
$$I_1 = E_{ii}$$
$$I_2 = \frac{1}{2!} \delta_{pq}^{ij} E_{pi} E_{qj}$$

The derivative of U with respect to a component of strain gives the corresponding component of stress

$$S_{ij} = \frac{\partial U}{\partial E_{ij}}$$

here,  $S_{ij}$ , is the second Piola-Kirchhoff stress tensor.

The load curve definition that provides the uniaxial data should give the change in gauge length,  $\Delta L$ , and the corresponding force. In compression both the force and the change in gauge length must be specified as negative values. In tension the force and change in gauge length should be input as positive values. The principal stretch ratio in the uniaxial direction,  $\lambda_1$ , is then given by

$$\lambda = \frac{L_o + \Delta L}{L_o}$$

Alternatively, the stress versus strain curve can also be input by setting the gauge length, thickness, and width to unity and defining the engineering strain in place of the change in gauge length and the nominal (engineering) stress in place of the force, see figure 27.2.

The least square fit to the experimental data is performed during the initialization phase and is a comparison between the fit and the actual input is provided in the printed file. It is a good idea to visually check the fit to make sure it is acceptable. The coefficients  $C_{100}$  -  $C_{020}$  are also printed in the output file.

\*MAT\_LAMINATED\_GLASS

This is Material Type 32. With this material model, a layered glass including polymeric layers can be modeled. Failure of the glass part is possible. See notes below.

Card 1            1            2            3            4            5            6            7            8

Variable	MID	RO	EG	PRG	SYG	ETG	EFG	EP
Type	A8	F	F	F	F	F	F	F

Card 2            1            2            3            4            5            6            7            8

Variable	PRP	SYP	ETP					
Type	F	F	F					

**Define 1-4 cards with a maximum of 32 number. If less than 4 cards are input, reading is stopped by a “\*” control card.**

Card 3...        1            2            3            4            5            6            7            8

Variable	F1	F2	F3	F4	F5	F6	F7	F8
Type	F	F	F	F	F	F	F	F

<u>VARIABLE</u>	<u>DESCRIPTION</u>
MID	Material identification. A unique number or label not exceeding 8 characters must be specified.
RO	Mass density
EG	Young’s modulus for glass
PRG	Poisson’s ratio for glass
SYG	Yield stress for glass
ETG	Plastic hardening modulus for glass

---

<u>VARIABLE</u>	<u>DESCRIPTION</u>
EFG	Plastic strain at failure for glass
EP	Young's modulus for polymer
PRP	Poisson's ratio for polymer
SYP	Yield stress for polymer
ETP	Plastic hardening modulus for polymer
F1,..FN	Integration point material: $f_n = 0.0$ : glass, $f_n = 1.0$ : polymer. A user-defined integration rule must be specified, see *INTEGRATION_SHELL. See remarks below.

**Remarks:**

Isotropic hardening for both materials is assumed. The material to which the glass is bonded is assumed to stretch plastically without failure. A user defined integration rule specifies the thickness of the layers making up the glass.  $F_i$  defines whether the integration point is glass (0.0) or polymer (1.0). The material definition,  $F_i$ , has to be given for the same number of integration points (NIPTS) as specified in the rule. A maximum of 32 layers is allowed.

If the recommended user defined rule is not defined, the default integration rules are used. The location of the integration points in the default rules are defined in the \*SECTION\_SHELL keyword description.

\*MAT\_BARLAT\_ANISOTROPIC\_PLASTICITY

This is Material Type 33. This model was developed by Barlat, Lege, and Brem [1991] for modeling anisotropic material behavior in forming processes. The finite element implementation of this model is described in detail by Chung and Shah [1992] and is used here. It is based on a six parameter model, which is ideally suited for 3D continuum problems, see notes below. For sheet forming problems, material 36 based on a 3-parameter model is recommended.

Card 1            1            2            3            4            5            6            7            8

Variable	MID	RO	E	PR	K	E0	N	M
Type	A8	F	F	F	F	F	F	F

Card 2            1            2            3            4            5            6            7            8

Variable	A	B	C	F	G	H	LCID	
Type	F	F	F	F	F	F	F	

Card 3            1            2            3            4            5            6            7            8

Variable	AOPT	OFFANG						
Type	F	F						

Card 4            1            2            3            4            5            6            7            8

Variable	XP	YP	ZP	A1	A2	A3		
Type	F	F	F	F	F	F		

Card 5            1            2            3            4            5            6            7            8

Variable	V1	V2	V3	D1	D2	D3		
Type	F	F	F	F	F	F		

<u>VARIABLE</u>	<u>DESCRIPTION</u>
MID	Material identification. A unique number or label not exceeding 8 characters must be specified.
RO	Mass density.
E	Young's modulus, E.
PR	Poisson's ratio, $\nu$ .
K	k, strength coefficient, see notes below.
EO	$\epsilon_0$ , strain corresponding to the initial yield, see notes below.
N	n, hardening exponent for yield strength.
M	m, flow potential exponent in Barlat's Model.
A	a, anisotropy coefficient in Barlat's Model.
B	b, anisotropy coefficient in Barlat's Model.
C	c anisotropy coefficient in Barlat's Model.
F	f, anisotropy coefficient in Barlat's Model.
G	g, anisotropy coefficient in Barlat's Model.
H	h, anisotropy coefficient in Barlat's Model.
LCID	Option load curve ID defining effective stress versus effective plastic strain. If nonzero, this curve will be used to define the yield stress. The load curve is implemented for solid elements only.

VARIABLE	DESCRIPTION
AOPT	<p>Material axes option:</p> <p>EQ.0.0: locally orthotropic with material axes determined by element nodes as shown in Figure 2.1. Nodes 1, 2, and 4 of an element are identical to the Nodes used for the definition of a coordinate system as by *DEFINE_COORDINATE_NODES.</p> <p>EQ.1.0: locally orthotropic with material axes determined by a point in space and the global location of the element center, this is the a-direction.</p> <p>EQ.2.0: globally orthotropic with material axes determined by vectors defined below, as with *DEFINE_COORDINATE_VECTOR.</p> <p>EQ.3.0: locally orthotropic material axes determined by offsetting the material axes by an angle, OFFANG, from a line determined by LT.0.0: the absolute value of AOPT is a coordinate system ID number (CID on *DEFINE_COORDINATE_NODES, *DEFINE_COORDINATE_SYSTEM or *DEFINE_COORDINATE_VECTOR). Available in R3 version of 971 and later.</p>
BETA	Offset angle for AOPT = 3.
MACF	<p>Material axes change flag for brick elements:</p> <p>EQ.1: No change, default,</p> <p>EQ.2: switch material axes a and b,</p> <p>EQ.3: switch material axes a and c,</p> <p>EQ.4: switch material axes b and c.</p>
XP YP ZP	Coordinates of point <b>p</b> for AOPT = 1.
A1 A2 A3	Components of vector <b>a</b> for AOPT = 2.
V1 V2 V3	Components of vector <b>v</b> for AOPT = 3.
D1 D2 D3	Components of vector <b>d</b> for AOPT = 2.

### Remarks:

The yield function  $\Phi$  is defined as:

$$\Phi = |S_1 - S_2|^m + |S_2 - S_3|^m + |S_3 - S_1|^m = 2\bar{\sigma}^m$$

where  $\bar{\sigma}$  is the effective stress and  $S_{i=1,2,3}$  are the principal values of the symmetric matrix  $S_{\alpha\beta}$ ,

$$S_{xx} = \left[ c(\sigma_{xx} - \sigma_{yy}) - b(\sigma_{zz} - \sigma_{xx}) \right] / 3$$

$$S_{yy} = \left[ a(\sigma_{yy} - \sigma_{zz}) - c(\sigma_{xx} - \sigma_{yy}) \right] / 3$$

$$S_{zz} = \left[ b(\sigma_{zz} - \sigma_{xx}) - a(\sigma_{yy} - \sigma_{zz}) \right] / 3$$

$$S_{yz} = f \sigma_{yz}$$

$$S_{zx} = g \sigma_{zx}$$

$$S_{xy} = h \sigma_{xy}$$

The material constants  $a$ ,  $b$ ,  $c$ ,  $f$ ,  $g$  and  $h$  represent anisotropic properties. When  $a = b = c = f = g = h = 1$ , the material is isotropic and the yield surface reduces to the Tresca yield surface for  $m=1$  and von Mises yield surface for  $m=2$  or 4.

For face centered cubic (FCC) materials  $m=8$  is recommended and for body centered cubic (BCC) materials  $m=6$  is used. The yield strength of the material is

$$\sigma_y = k (\varepsilon^p + \varepsilon_0)^n$$

where  $\varepsilon_0$  is the strain corresponding to the initial yield stress and  $\varepsilon^p$  is the plastic strain.



\*MAT\_BARLAT\_YLD96

This is Material Type 33. This model was developed by Barlat, Maeda, Chung, Yanagawa, Brem, Hayashida, Lege, Matsui, Murtha, Hattori, Becker, and Makosey [1997] for modeling anisotropic material behavior in forming processes in particular for aluminum alloys. This model is available for shell elements only.

Card 1            1            2            3            4            5            6            7            8

Variable	MID	RO	E	PR	K			
Type	A8	F	F	F	F			

Card 2            1            2            3            4            5            6            7            8

Variable	E0	N	ESR0	M	HARD	A		
Type	F	F	F	F	F	F		

Card 3            1            2            3            4            5            6            7            8

Variable	C1	C2	C3	C4	AX	AY	AZ0	AZ1
Type	F	F	F	F	F	F	F	F

Card 4            1            2            3            4            5            6            7            8

Variable	AOPT	OFFANG						
Type	F	F						

Card 5            1            2            3            4            5            6            7            8

Variable				A1	A2	A3		
Type				F	F	F		

Card 6            1            2            3            4            5            6            7            8

Variable	V1	V2	V3	D1	D2	D3		
Type	F	F	F	F	F	F		

<u>VARIABLE</u>	<u>DESCRIPTION</u>
MID	Material identification. A unique number or label not exceeding 8 characters must be specified.
RO	Mass density.
E	Young's modulus, E.
PR	Poisson's ratio, $\nu$ .
K	$k$ , strength coefficient or $a$ in Voce, see notes below.
EO	$\epsilon_0$ , strain corresponding to the initial yield or $b$ in Voce, see notes below.
N	$n$ , hardening exponent for yield strength or $c$ in Voce.
ESR0	$\epsilon_{SR0}$ , in powerlaw rate sensitivity.
M	$m$ , exponent for strain rate effects
HARD	Hardening option: LT. 0.0: absolute value defines the load curve ID. EQ. 1.0: powerlaw EQ. 2.0: Voce
A	Flow potential exponent.
C1	$c1$ , see equations below.

<u>VARIABLE</u>	<u>DESCRIPTION</u>
C2	c2, see equations below.
C3	c3, see equations below.
C4	c4, see equations below.
AX	ax, see equations below.
AY	ay, see equations below.
AZ0	az0, see equations below.
AZ1	az1, see equations below.
AOPT	<p>Material axes option:</p> <p>EQ.0.0: locally orthotropic with material axes determined by element nodes as shown in Figure 2.1. Nodes 1, 2, and 4 of an element are identical to the Nodes used for the definition of a coordinate system as by *DEFINE_COORDINATE_NODES.</p> <p>EQ.2.0: globally orthotropic with material axes determined by vectors defined below, as with *DEFINE_COORDINATE_VECTOR.</p> <p>EQ.3.0: locally orthotropic material axes determined by offsetting the material axes by an angle, OFFANG, from a line determined by taking the cross product of the vector <b>v</b> with the normal to the plane of the element.</p> <p>LT.0.0: the absolute value of AOPT is a coordinate system ID number (CID on *DEFINE_COORDINATE_NODES, *DEFINE_COORDINATE_SYSTEM or *DEFINE_COORDINATE_VECTOR). Available in R3 version of 971 and later.</p>
OFFANG	Offset angle for AOPT = 3.
A1 A2 A3	Components of vector <b>a</b> for AOPT = 2.
V1 V2 V3	Components of vector <b>v</b> for AOPT = 3.
D1 D2 D3	Components of vector <b>d</b> for AOPT = 2.

### **Remarks:**

The yield stress  $\sigma_y$  is defined three ways. The first, the Swift equation, is given in terms of the input constants as:

$$\sigma_y = k (\epsilon_0 + \epsilon^p)^n \left( \frac{\dot{\epsilon}}{\epsilon_{SR0}} \right)^m$$

The second, the Voce equation, is defined as:

$$\sigma_y = a - be^{-c\epsilon^p}$$

and the third option is to give a load curve ID that defines the yield stress as a function of effective plastic strain. The yield function  $\Phi$  is defined as:

$$\Phi = \alpha_1 |s_1 - s_2|^a + \alpha_2 |s_2 - s_3|^a + \alpha_3 |s_3 - s_1|^a = 2\sigma_y^a$$

where  $s_i$  is a principle component of the deviatoric stress tensor where in vector notation:

$$\underline{s} = \underline{L}\underline{\sigma}$$

and  $\underline{L}$  is given as

$$\underline{L} = \begin{bmatrix} \frac{c_2 + c_3}{3} & \frac{-c_3}{3} & \frac{-c_2}{3} & 0 \\ \frac{-c_3}{3} & \frac{c_3 + c_1}{3} & \frac{-c_1}{3} & 0 \\ \frac{-c_2}{3} & \frac{-c_1}{3} & \frac{c_1 + c_2}{3} & 0 \\ 0 & 0 & 0 & c_4 \end{bmatrix}$$

A coordinate transformation relates the material frame to the principle directions of  $\underline{s}$  is used to obtain the  $\alpha_k$  coefficients consistent with the rotated principle axes:

$$\alpha_k = \alpha_x p_{1k}^2 + \alpha_y p_{2k}^2 + \alpha_z p_{3k}^2$$

$$\alpha_z = \alpha_{z0} \cos^2 2\beta + \alpha_{z1} \sin^2 2\beta$$

where  $p_{ij}$  are components of the transformation matrix. The angle  $\beta$  defines a measure of the rotation between the frame of the principal value of  $\underline{s}$  and the principal anisotropy axes.

\*MAT\_FABRIC

This is Material Type 34. This material is especially developed for airbag materials. The fabric model is a variation on the layered orthotropic composite model of material 22 and is valid for 3 and 4 node membrane elements only. In addition to being a constitutive model, this model also invokes a special membrane element formulation which is more suited to the deformation experienced by fabrics under large deformation. For thin fabrics, buckling can result in an inability to support compressive stresses; thus a flag is included for this option. A linearly elastic liner is also included which can be used to reduce the tendency for these elements to be crushed when the no-compression option is invoked. In LS-DYNA versions after 931 the isotropic elastic option is available.

Card 1            1            2            3            4            5            6            7            8

Variable	MID	RO	EA	EB	EC	PRBA	PRCA	PRCB
Type	A8	F	F	F	F	F	F	F

Card 2            1            2            3            4            5            6            7            8

Variable	GAB	GBC	GCA	CSE	EL	PRL	LRATIO	DAMP
Type	F	F	F	F	F	F	F	F
Remarks				1	2	2	2	

Card 3            1            2            3            4            5            6            7            8

Variable	AOPT	FLC/X2	FAC/X3	ELA	LNRC	FORM	FVOPT	TSRFAC
Type	F	F	F	F	F	F	F	F
Remarks		3	3		4	0	0	9



VARIABLE	DESCRIPTION
EA	Young's modulus - longitudinal direction. For an isotropic elastic fabric material only EA and PRBA are defined and are used as the isotropic Young's modulus and Poisson's ratio, respectively. The input for the fiber directions and liner should be input as zero for the isotropic elastic fabric
EB	Young's modulus - transverse direction, set to zero for isotropic elastic material.
(EC)	Young's modulus - normal direction, set to zero for isotropic elastic material. (Not used)
PRBA	$\nu_{ba}$ , Poisson's ratio ba direction.
(PRCA)	$\nu_{ca}$ , Poisson's ratio ca direction, set to zero for isotropic elastic material. (Not used)
(PRCB)	$\nu_{cb}$ , Poisson's ratio cb direction, set to zero for isotropic elastic material. (Not used)
GAB	$G_{ab}$ , shear modulus ab direction, set to zero for isotropic elastic material.
(GBC)	$G_{bc}$ , shear modulus bc direction, set to zero for isotropic elastic material. (Not used)
(GCA)	$G_{ca}$ , shear modulus ca direction, set to zero for isotropic elastic material. (Not used)
CSE	Compressive stress elimination option (default 0.0): EQ.0.0: don't eliminate compressive stresses, EQ.1.0: eliminate compressive stresses (This option does not apply to the liner).
EL	Young's modulus for elastic liner (optional).
PRL	Poisson's ratio for elastic liner (optional).
LRATIO	Ratio of liner thickness to total fabric thickness.
DAMP	Rayleigh damping coefficient. A 0.05 coefficient is recommended corresponding to 5% of critical damping. Sometimes larger values are necessary.

VARIABLE	DESCRIPTION
AOPT	<p>Material axes option (see MAT_OPTION TROPIC_ELASTIC for a more complete description):</p> <p>EQ.0.0: locally orthotropic with material axes determined by element nodes 1, 2, and 4, as with *DEFINE_COORDINATE_NODES, and then rotated about the element normal by an angle BETA.</p> <p>EQ.2.0: globally orthotropic with material axes determined by vectors defined below, as with *DEFINE_COORDINATE_VECTOR.</p> <p>EQ.3.0: locally orthotropic material axes determined by rotating the material axes about the element normal by an angle, BETA, from a line in the plane of the element defined by the cross product of the vector <math>\mathbf{v}</math> with the element normal.</p> <p>LT.0.0: the absolute value of AOPT is a coordinate system ID number (CID on *DEFINE_COORDINATE_NODES, *DEFINE_COORDINATE_SYSTEM or *DEFINE_COORDINATE_VECTOR). Available in R3 version of 971 and later.</p>
FLC/X2	<p>If <math>X0 \neq 0, X0 \neq 1</math>: This is X2 coefficient of the porosity equation of Anagonye and Wang [1999]. Else, this is an optional constant, FLC, a fabric porous leakage flow coefficient.</p> <p>LT.0.0: There are two possible definitions.</p> <p>If <math>X0 = 0</math>,  FLC  is the load curve ID of the curve defining FLC versus time.</p> <p>If <math>X0 = 1</math>,  FLC  is the load curve ID defining FLC versus the stretching ratio defined as <math>r_s = A / A_0</math>. See notes below.</p>
FAC/X3	<p>If <math>X0 \neq 0, X0 \neq 1</math>: This is X3 coefficient of the porosity equation of Anagonye and Wang [1999]. Else, if and only if <math>X0 = 0</math>: This is an optional constant, FAC, a fabric characteristic parameter.</p> <p>LT.0.0: There are three possible definitions.</p> <p>If FVOPT &lt; 7:</p> <p>If <math>X0 = 0</math>,  FAC  is the load curve ID of the curve defining FAC versus <u>absolute</u> pressure.</p> <p>If <math>X0 = 1</math>,  FAC  is the load curve ID defining FAC versus the pressure ratio defined as <math>r_p = P_{air} / P_{bag}</math>. See remark 3 below.</p> <p>If FVOPT = 7 or 8:</p> <p>FAC defines leakage volume flux rate versus absolute pressure. The volume flux (per area) rate (per time) has the unit of <math>\text{vol}_{flux} \approx m^3 / [m^2 s] \approx m/s</math>, equivalent to relative porous gas speed.</p>
ELA	<p>Effective leakage area for blocked fabric, ELA.</p> <p>LT.0.0:  ELA  is the load curve ID of the curve defining ELA versus time. The default value of zero assumes that no leakage occurs. A value of .10 would assume that 10% of the blocked fabric is leaking gas.</p>



VARIABLE	DESCRIPTION
LNRC	<p>Flag to turn off compression in liner until the reference geometry is reached, i.e., the fabric element becomes tensile.</p> <p>EQ.0.0: off. EQ.1.0: on.</p>
FORM	<p>Flag to modify membrane formulation for fabric material:</p> <p>EQ.0.0: default. Least costly and very reliable. EQ.1.0: invariant local membrane coordinate system EQ.2.0: Green-Lagrange strain formulation EQ.3.0: large strain with nonorthogonal material angles. See Remark 5. EQ.4.0: large strain with nonorthogonal material angles and nonlinear stress strain behavior. Define optional load curve IDs on optional card. EQ.12.0: Updated form 2. See Remark 10. EQ.13.0: Updated form 3. See Remark 10. EQ.14.0: Updated form 4. See Remark 10. EQ.-14.0: Same as form 14, but invokes reading of card 7. See Remark 12.</p>
FVOPT	<p>Fabric venting option.</p> <p>EQ.1: Wang-Nefske formulas for venting through an orifice are used. Blockage is not considered. EQ.2: Wang-Nefske formulas for venting through an orifice are used. Blockage of venting area due to contact is considered. EQ.3: Leakage formulas of Graefe, Krummheuer, and Siejak [1990] are used. Blockage is not considered. EQ.4: Leakage formulas of Graefe, Krummheuer, and Siejak [1990] are used. Blockage of venting area due to contact is considered. EQ.5: Leakage formulas based on flow through a porous media are used. Blockage is not considered. EQ.6: Leakage formulas based on flow through a porous media are used. Blockage of venting area due to contact is considered. EQ.7: Leakage is based on gas volume outflow versus pressure load curve [Lian, 2000]. Blockage is not considered. Absolute pressure is used in the porous-velocity-versus-pressure load curve, given as FAC in the *MAT_FABRIC card. EQ.8: Leakage is based on gas volume outflow versus pressure load curve [Lian 2000]. Blockage of venting or porous area due to contact is considered. Absolute pressure is used in the porous-velocity-versus-pressure load curve, given as FAC in the *MAT_FABRIC card.</p>
TSRFAC	<p>Tensile stress cutoff reduction factor</p> <p>LT.0:  TSRFAC  is the curve ID of the curve defining TSRFAC versus time. GT.0 and LT.1: TSRFAC applied from time 0. GE.1: TSRFAC is a curve ID for the new option.</p>
A1 A2 A3	<p>Components of vector <b>a</b> for AOPT = 2.</p>

VARIABLE	DESCRIPTION
X0,X1	Coefficients of Anagonye and Wang [1999] porosity equation for the leakage area: $A_{leak} = A_0 (X_0 + X_1 r_s + X_2 r_p + X_3 r_s r_p)$
V1 V2 V3	Components of vector <b>v</b> for AOPT = 3.
D1 D2 D3	Components of vector <b>d</b> for AOPT = 2.
BETA	Material angle in degrees for AOPT = 0 and 3, may be overridden on the element card, see *ELEMENT_SHELL_BETA.
ISREFG	Initial stress by reference geometry for FORM=12 EQ.0.0: default. Not active. EQ.1.0: active
LCA	Load curve or table ID. Load curve ID defines the stress versus uniaxial strain along the a-axis fiber. Table ID defines for each strain rate a load curve representing stress versus uniaxial strain along the a-axis fiber. Available for FORM=4, 14 and -14 only, table allowed only for form=-14. If zero, EA is used.
LCB	Load curve or table ID. Load curve ID defines the stress versus uniaxial strain along the b-axis fiber. Table ID defines for each strain rate a load curve representing stress versus uniaxial strain along the b-axis fiber. Available for FORM=4, 14 and -14 only, table allowed only for form=-14. If zero, EB is used.
LCAB	Load curve ID for shear stress versus shear strain in the ab-plane; available for FORM=4 or 14 only. If zero, GAB is used.
LCUA	Unload/reload curve ID for stress versus strain along the a-axis fiber; available for FORM=4 or 14 only. If zero, LCA is used.
LCUB	Unload/reload curve ID for stress versus strain along the b-axis fiber; available for FORM=4 or 14 only. If zero, LCB is used.
LCUAB	Unload/reload curve ID for shear stress versus shear strain in the ab-plane; available for FORM=4 or 14 only. If zero, LCAB is used.
RL	Optional reloading parameter for FORM=14. Values between 0.0 (reloading on unloading curve-default) and 1.0 (reloading on a minimum linear slope between unloading curve and loading curve) are possible.
LCAA	Load curve or table ID. Load curve ID defines the stress along the a-axis fiber versus biaxial strain. Table ID defines for each directional strain rate a load curve representing stress along the a-axis fiber versus biaxial strain. Available for FORM=-14 only, if zero, LCA is used.

VARIABLE	DESCRIPTION
LCBB	Load curve or table ID. Load curve ID defines the stress along the b-axis fiber versus biaxial strain. Table ID defines for each directional strain rate a load curve representing stress along the b-axis fiber versus biaxial strain. Available for FORM=-14 only, if zero, LCB is used.
H	Normalized hysteresis parameter between 0 and 1.
DT	Strain rate averaging option. EQ.0.0: Strain rate is evaluated using a running average. LT.0.0: Strain rate is evaluated using average of last 11 time steps. GT.0.0: Strain rate is averaged over the last DT time units.

### **Remarks:**

1. The no compression option allows the simulation of airbag inflation with far less elements than would be needed for the discretization of the wrinkles which would occur for the case when compressive stresses are not eliminated.
2. When using this material for the analysis of membranes as airbags it is well known from classical theory that only one layer has to be defined. The so-called elastic liner has to be defined for numerical purposes only when the no compression option is invoked.
3. The parameters FLC and FAC are optional for the Wang-Nefske inflation models. It is possible for the airbag to be constructed of multiple fabrics having different values for porosity and permeability. The leakage of gas through the fabric in an airbag then requires an accurate determination of the areas by part ID available for leakage. The leakage area may change over time due to stretching of the airbag fabric or blockage when the bag contacts the structure. LS-DYNA can check the interaction of the bag with the structure and split the areas into regions that are blocked and unblocked depending on whether the regions are in or not in contact, respectively. Typically, FLC and FAC must be determined experimentally and their variations in time or with pressure are optional to allow for maximum flexibility.
4. The elastic backing layer always acts in tension and compression since the tension cutoff option, CSE, does not apply. This can sometimes cause difficulties if the elements are very small in relationship to their actual size as defined by the reference geometry (See \*AIRBAG\_REFERENCE\_GEOMETRY.). If the flag, LNRC, is set to 1.0 the elastic liner does not begin to act until the area of defined by the reference geometry is reached.
5. For FORM=0, 1, and 2, the a-axis and b-axis fiber directions are assumed to be orthogonal and are completely defined by the material axes option, AOPT=0, 2, or 3. For FORM=3, 4, 13, or 14, the fiber directions are not assumed orthogonal and must be specified using the ICOMP=1 option on \*SECTION\_SHELL. Offset angles should be input into the B1 and B2 fields used normally for integration points 1 and 2. The a-axis and b-axis directions will then be offset from the a-axis direction as determined by the material axis option, AOPT=0, 2, or 3.

6. For FORM=4 or 14, 2<sup>nd</sup> Piola-Kirchoff stress vs. Green's strain curves may be defined for a-axis, b-axis, and shear stresses for loading and also for unloading and reloading. All curves should start at the origin and be defined for positive strains only. The a-axis and b-axis stress follows the curves for tension only. For compression, stress is calculated from the constant values, EA or EB. Shear stress/strain behavior is assumed symmetric. If a load curve is omitted, the stress is calculated from the appropriate constant modulus, EA, EB, or GAB.
7. When both loading and unloading curves are defined, the initial yield strain is assumed to be equal to the strain at the first point in the load curve with stress greater than zero. When strain exceeds the yield strain, the stress continues to follow the load curve and the yield strain is updated to the current strain. When unloading occurs, the unload/reload curve is shifted along the x-axis until it intersects the load curve at the current yield strain. If the curve shift is to the right, unloading and reloading will follow the shifted unload/reload curve. If the curve shift is zero or to the left, unloading and reloading will occur along the load curve. When using unloading curves, compressive stress elimination should be active to prevent the fibers from developing compressive stress during unloading when the strain remains tensile. If LCUA, LCUB, or LCUAB are input with negative values, then unloading is handled differently. Instead of shifting the unload curve along the x-axis, the curve is stretched in the x-direction such that the first point remains at (0,0) and the unload curve intersects with the load curve at the current yield point. This option guarantees the stress remains tensile while the strain is tensile so compressive stress elimination is not necessary. To use this option the unload curve should have an initial slope less steep than the load curve, and should steepen such that it intersects the load curve at some positive strain value.
8. The FVOPT flag allows an airbag fabric venting equation to be assigned to an material. The anticipated use for this option is to allow a vent to be defined using FVOPT=1 or 2 for one material and fabric leakage to be defined for using FVOPT=3, 4, 5, or 6 for other materials. In order to use FVOPT, a venting option must first be defined for the airbag using the OPT parameter on \*AIRBAG\_WANG\_NEFSKE or \*AIRBAG\_HYBRID. If OPT=0, then FVOPT is ignored. If OPT is defined and FVOPT is omitted, then FVOPT is set equal to OPT.
9. The TSRFAC factor is used to assure that airbags that have a reference geometry will open to the correct geometry. Airbags that use a reference geometry might have an initial geometry that results in initial strains. To prevent such strains from prematurely opening an airbag, these strains are eliminated by default. A side effect of this behavior is that airbags that use a reference geometry and that are initially stretched will never achieve the correct shape. The TSRFAC factor is used to restore the tensile strains over time such that the correct geometry is achieved. It is recommended that a load curve be used to define TSRFAC as function of time. Initially the load curve ordinate value should be 0.0 which will allow the bag to remain unstressed. At a time when the bag is partially open, the value of TSRFAC should ramp up to a small number of about 0.0001. Each cycle, the stored initial strains are scaled by (1.0-TSRFAC) such that they reduce to a very small number. A new option is invoked by setting TSRFAC $\geq$ 1 in which case TSRFAC is a curve ID. The curve should ramp from 0.0 to 1.0. When the curve ordinate value is 0.0, the stored initial strain is subtracted from the total strain. For values between 0.0 and 1.0, a fraction of the stored initial strain is subtracted from the total strain where the fraction is 1.0-TSRFAC. When the curve value reaches or exceeds 1.0, the total strain is used. This option gives the user better control of the rate of restoring the strains as it is independent of the solution time step.

10. Material forms 12, 13, and 14 are updated versions of forms 2, 3, and 4, respectively. These new forms are intended to be less susceptible to timestep collapse and also guarantee zero stress in the initial geometry when a reference geometry is used. The behavior should otherwise be similar with one exception. The LNRC flag eliminates not only initial compressive strain but total initial strain. Therefore, the TSRFAC option is recommended (see Remark 9) when forms 12, 13, and 14 are used with a reference geometry and LNRC=1.
11. An option to calculate the initial stress by using a reference geometry is available for material FORM 12 only.
12. If tables are used the strain rate measure is the Green-Lagrange strain rate of the Green-Lagrange strain in the direction of interest. To suppress noise the strain rate is averaged according to the value of DT. If  $DT > 0$ , it is recommended to use a large enough value to suppress the noise but small enough to not lose important frequency content. This option seems to be the most robust averaging choice.
13. The hysteresis parameter H defines the fraction of dissipated energy during a load cycle in terms of the maximum possible dissipated energy. Referring to the figure below,  $H \approx A_1 / (A_1 + A_2)$

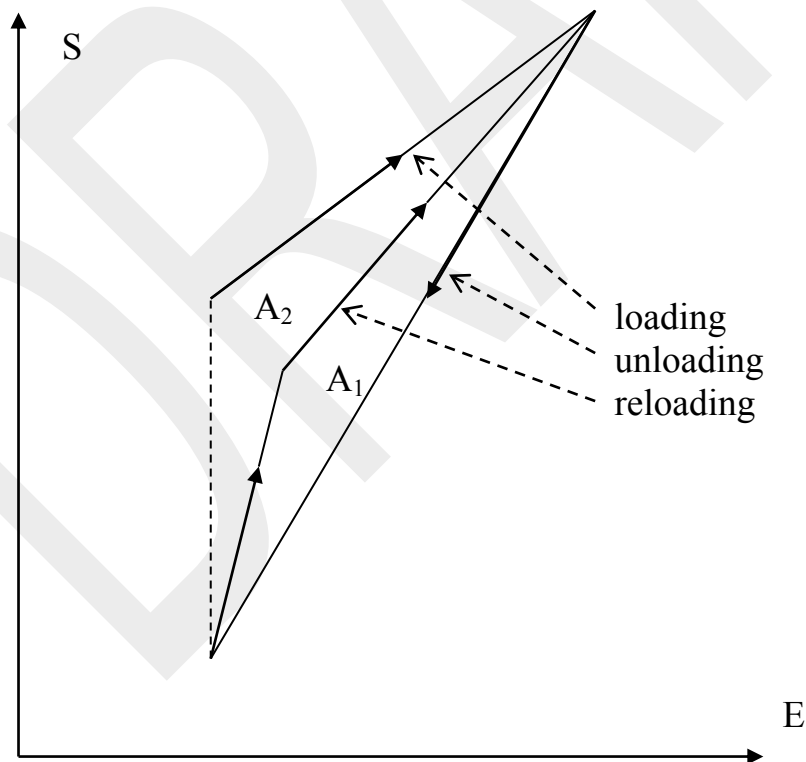

**\*MAT\_PLASTIC\_GREEN-NAGHDI\_RATE**

This is Material Type 35. This model is available only for brick elements and is similar to model 3, but uses the Green-Naghdi Rate formulation rather than the Jaumann rate for the stress update. For some cases this might be helpful. This model also has a strain rate dependency following the Cowper-Symonds model.

Card 1            1            2            3            4            5            6            7            8

Variable	MID	RO	E	PR				
Type	A8	F	F	F				

Card 2            1            2            3            4            5            6            7            8

Variable	SIGY	ETAN	SRC	SRP	BETA			
Type	F	F	F	F	F			

<u>VARIABLE</u>	<u>DESCRIPTION</u>
MID	Material identification. A unique number or label not exceeding 8 characters must be specified.
RO	Density
E	Young's modulus
PR	Poisson's ratio
SIGY	Yield stress
ETAN	Plastic hardening modulus
SRC	Strain rate parameter, C
SRP	Strain rate parameter, P
BETA	Hardening parameter, $0 < \beta' < 1$

## \*MAT\_3-PARAMETER\_BARLAT\_{OPTION}

This is Material Type 36. This model was developed by Barlat and Lian [1989] for modeling sheets with anisotropic materials under plane stress conditions. This material allows the use of the Lankford parameters for the definition of the anisotropy. This particular development is due to Barlat and Lian [1989]. A version of this material model which has a flow limit diagram failure option is \*MAT\_FLD\_3-PARAMETER\_BARLAT.

Available options include:

<BLANK>

**NLP**

The option **NLP** allows for prediction of sheet metal failure using the Formability Index (F.I.), which accounts for the non-linear strain path effect (see **Remarks** below). The variable NLP in card #3 needs to be defined when using the option.

Card 1            1            2            3            4            5            6            7            8

Variable	MID	RO	E	PR	HR	P1	P2	ITER
Type	A8	F	F	F	F	F	F	F

Card 2            1            2            3            4            5            6            7            8

Variable	M	R00 / AB	R45 / CB	R90 / HB	LCID	E0	SPI	P3
Type	F	F	F	F	I	F	F	F

**Define the following card if and only if M<0**

Card opt.        1            2            3            4            5            6            7            8

Variable	CRC1	CRA1	CRC2	CRA2	CRC3	CRA3	CRC4	CRA4
Type	F	F	F	F	F	F	F	F

Card 3            1            2            3            4            5            6            7            8

Variable	AOPT	C	P	VLCID		PB	NLP/HTA	HTB
Type	F	F	F	I		F	I/F	F

Card 4            1            2            3            4            5            6            7            8

Variable				A1	A2	A3	HTC	HTD
Type				F	F	F	F	F

Card 5            1            2            3            4            5            6            7            8

Variable	V1	V2	V3	D1	D2	D3	BETA	HTFLAG
Type	F	F	F	F	F	F	F	F

<u>VARIABLE</u>	<u>DESCRIPTION</u>
MID	Material identification. A unique number or label not exceeding 8 characters must be specified.
RO	Mass density.
E	Young's modulus, E GT.0.0: Constant value, LT.0.0: Load curve ID = (-E) which defines Young's Modulus as a function of plastic strain. See Remark 1.
PR	Poisson's ratio, $\nu$



VARIABLE	DESCRIPTION
HR	<p>Hardening rule:</p> <p>EQ.1.0: linear (default),</p> <p>EQ.2.0: exponential (Swift)</p> <p>EQ.3.0: load curve or table with strain rate effects</p> <p>EQ.4.0: exponential (Voce)</p> <p>EQ.5.0: exponential (Gosh)</p> <p>EQ.6.0: exponential (Hockett-Sherby)</p> <p>EQ.7.0: load curves in three directions</p> <p>EQ.8.0: table with temperature dependence</p> <p>EQ.9.0: 3d table with temperature and strain rate dependence</p>
P1	<p>Material parameter:</p> <p>HR.EQ.1.0: Tangent modulus,</p> <p>HR.EQ.2.0: k, strength coefficient for Swift exponential hardening</p> <p>HR.EQ.4.0: a, coefficient for Voce exponential hardening</p> <p>HR.EQ.5.0: k, strength coefficient for Gosh exponential hardening</p> <p>HR.EQ.6.0: a, coefficient for Hockett-Sherby exponential hardening</p> <p>HR.EQ.7.0: load curve ID for hardening in 45 degree direction. See Remark 2.</p>
P2	<p>Material parameter:</p> <p>HR.EQ.1.0: Yield stress</p> <p>HR.EQ.2.0: n, exponent for Swift exponential hardening</p> <p>HR.EQ.4.0: c, coefficient for Voce exponential hardening</p> <p>HR.EQ.5.0: n, exponent for Gosh exponential hardening</p> <p>HR.EQ.6.0: c, coefficient for Hockett-Sherby exponential hardening</p> <p>HR.EQ.7.0: load curve ID for hardening in 90 degree direction. See Remark 2.</p>
ITER	<p>Iteration flag for speed:</p> <p>ITER.EQ.0.0: fully iterative</p> <p>ITER.EQ.1.0: fixed at three iterations</p> <p>Generally, ITER=0 is recommended. However, ITER=1 is somewhat faster and may give acceptable results in most problems.</p>
M	<p>m, exponent in Barlat's yield surface, absolute value is used if negative.</p>
CRCN	<p>Chaboche-Roussiler hardening parameter, see remarks.</p>
CRCA	<p>Chaboche-Roussiler hardening parameter, see remarks.</p>
R00	<p>R<sub>00</sub>, Lankford parameter in 0 degree direction</p> <p>GT.0.0: Constant value,</p> <p>LT.0.0: Load curve or Table ID = (-R00) which defines R value as a function of plastic strain (Curve) or as a function of temperature and plastic strain (Table). See Remark 3.</p>

VARIABLE	DESCRIPTION
R45	<p>R<sub>45</sub>, Lankford parameter in 45 degree direction            GT.0.0: Constant value,            LT.0.0: Load curve or Table ID = (-R45) which defines R value as a function of plastic strain (Curve) or as a function of temperature and plastic strain (Table). See Remarks 2 and 3.</p>
R90	<p>R<sub>90</sub>, Lankford parameter in 90 degree direction            GT.0.0: Constant value,            LT.0.0: Load curve or Table ID = (-R90) which defines R value as a function of plastic strain (Curve) or as a function of temperature and plastic strain (Table). See Remarks 2 and 3.</p>
AB	<p>a, Barlat89 parameter, which is read instead of R00 if PB&gt;0.</p>
CB	<p>c, Barlat89 parameter, which is read instead of R45 if PB&gt;0.</p>
HB	<p>h, Barlat89 parameter, which is read instead of R90 if PB&gt;0.</p>
LCID	<p>Load curve/table ID for hardening in the 0 degree direction. See Remark 1.</p>
E0	<p>Material parameter            HR.EQ.2.0: <math>\epsilon_0</math> for determining initial yield stress for Swift exponential hardening. (Default=0.0)            HR.EQ.4.0: b, coefficient for Voce exponential hardening            HR.EQ.5.0: <math>\epsilon_0</math> for determining initial yield stress for Gosh exponential hardening. (Default=0.0)            HR.EQ.6.0: b, coefficient for Hocket-Sherby exponential hardening</p>
SPI	<p><i>spi</i>, if <math>\epsilon_0</math> is zero above and HR.EQ.2.0. (Default=0.0)            EQ.0.0: <math>\epsilon_0 = (E / k) ** [1 / (n - 1)]</math>            LE.0.02: <math>\epsilon_0 = spi</math>            GT.0.02: <math>\epsilon_0 = (spi / k) ** [1 / n]</math>            If HR.EQ.5.0 the strain at plastic yield is determined by an iterative procedure based on the same principles as for HR.EQ.2.0.</p>
P3	<p>Material parameter:            HR.EQ.5.0: p, parameter for Gosh exponential hardening            HR.EQ.6.0: n, exponent for Hocket-Sherby exponential hardening</p>

VARIABLE	DESCRIPTION
AOPT	Material axes option (see MAT_OPTION TROPIC_ELASTIC for a more complete description): EQ.0.0: locally orthotropic with material axes determined by element nodes 1, 2, and 4, as with *DEFINE_COORDINATE_NODES, and then rotated about the shell element normal by an angle BETA. EQ.2.0: globally orthotropic with material axes determined by vectors defined below, as with *DEFINE_COORDINATE_VECTOR. EQ.3.0: locally orthotropic material axes determined by rotating the material axes about the element normal by an angle, BETA, from a line in the plane of the element defined by the cross product of the vector <b>v</b> with the element normal. LT.0.0: the absolute value of AOPT is a coordinate system ID number (CID on *DEFINE_COORDINATE_NODES, *DEFINE_COORDINATE_SYSTEM or *DEFINE_COORDINATE_VECTOR). Available with the R3 release of Version 971 and later.
C	C in Cowper-Symonds strain rate model
P	p in Cowper-Symonds strain rate model, p=0.0 for no strain rate effects
VLCID	Volume correction curve ID defining the relative volume change (change in volume relative to the initial volume) as a function of the effective plastic strain. This is only used when nonzero. See Remark 1.
PB	Barlat89 parameter, p. If PB>0, parameters AB, CB, and HB are read instead of R00, R45, and R90. See Remark 4.
NLP	Load curve ID of the Forming Limit Diagram (FLD) under linear strain paths (see <b>Remarks</b> below). Define when option _NLP is used.
HTA	Load curve/Table ID for postforming parameter A in heat treatment
HTB	Load curve/Table ID for postforming parameter B in heat treatment
XP YP ZP	Coordinates of point <b>p</b> for AOPT = 1.
A1 A2 A3	Components of vector <b>a</b> for AOPT = 2.
HTC	Load curve/Table ID for postforming parameter C in heat treatment
HTD	Load curve/Table ID for postforming parameter D in heat treatment
V1 V2 V3	Components of vector <b>v</b> for AOPT = 3.
D1 D2 D3	Components of vector <b>d</b> for AOPT = 2.

VARIABLE	DESCRIPTION
BETA	Material angle in degrees for AOPT=0 and 3, may be overridden on the element card, see *ELEMENT_SHELL_BETA.
HTFLAG	Heat treatment flag (see remarks): HTFLAG.EQ.0: Preforming stage HTFLAG.EQ.1: Heat treatment stage HTFLAG.EQ.2: Postforming stage

**Remarks:**

- The effective plastic strain used in this model is defined to be plastic work equivalent. A consequence of this is that for parameters defined as functions of effective plastic strain, the rolling (00) direction should be used as reference direction. For instance, the hardening curve for HR=3 is the stress as function of strain for uniaxial tension in the rolling direction, VLCID curve should give the relative volume change as function of strain for uniaxial tension in the rolling direction and load curve given by -E should give the Young's modulus as function of strain for uniaxial tension in the rolling direction. Optionally the curve can be substituted for a table defining hardening as function of plastic strain rate (HR=3) or temperature (HR=8).
- Exceptions from the rule above are curves defined as functions of plastic strain in the 45 and 90 directions, i.e., P1 and P2 for HR=7 and negative R45 or R90. The hardening curves are here defined as measured stress as function of measured plastic strain for uniaxial tension in the direction of interest, i.e., as determined from experimental testing using a standard procedure. Moreover, the curves defining the R values are as function of the measured plastic strain for uniaxial tension in the direction of interest. These curves are transformed internally to be used with the effective stress and strain properties in the actual model. The effective plastic strain does not coincide with the plastic strain components in other directions than the rolling direction and may be somewhat confusing to the user. Therefore the von Mises work equivalent plastic strain is output as history variable #2 if HR=7 or if any of the R-values is defined as function of the plastic strain.
- The R-values in curves are defined as the ratio of instantaneous width change to instantaneous thickness change. That is, assume that the width W and thickness T are measured as function of strain. Then the corresponding R-value is given by:

$$R = \frac{\frac{dW}{W}}{\frac{dT}{T}}$$

- The anisotropic yield criterion  $\Phi$  for plane stress is defined as:

$$\Phi = a|K_1 + K_2|^m + a|K_1 - K_2|^m + c|2K_2|^m = 2\sigma_Y^m$$

where  $\sigma_y$  is the yield stress and  $K_{i=1,2}$  are given by:

$$K_1 = \frac{\sigma_x + h\sigma_y}{2}$$

$$K_2 = \sqrt{\left(\frac{\sigma_x - h\sigma_y}{2}\right)^2 + p^2 \tau_{xy}^2}$$

If  $PB=0$ , the anisotropic material constants  $a$ ,  $c$ ,  $h$ , and  $p$  are obtained through  $R_{00}$ ,  $R_{45}$ , and  $R_{90}$ :

$$a = 2 - 2\sqrt{\frac{R_{00}}{1+R_{00}} \frac{R_{90}}{1+R_{90}}} \quad c = 2 - a$$

$$h = \sqrt{\frac{R_{00}}{1+R_{00}} \frac{1+R_{90}}{R_{90}}}$$

The anisotropy parameter  $p$  is calculated implicitly. According to Barlat and Lian the  $R$  value, width to thickness strain ratio, for any angle  $\phi$  can be calculated from:

$$R_\phi = \frac{2m\sigma_y^m}{\left(\frac{\partial\Phi}{\partial\sigma_x} + \frac{\partial\Phi}{\partial\sigma_y}\right)\sigma_\phi} - 1$$

where  $\sigma_\phi$  is the uniaxial tension in the  $\phi$  direction. This expression can be used to iteratively calculate the value of  $p$ . Let  $\phi=45$  and define a function  $g$  as

$$g(p) = \frac{2m\sigma_y^m}{\left(\frac{\partial\Phi}{\partial\sigma_x} + \frac{\partial\Phi}{\partial\sigma_y}\right)\sigma_\phi} - 1 - R_{45}$$

An iterative search is used to find the value of  $p$ .

If  $PB>0$ , material parameters  $a$  (AB),  $c$  (CB),  $h$  (HB), and  $p$  (PB) are used directly.

For face centered cubic (FCC) materials  $m=8$  is recommended and for body centered cubic (BCC) materials  $m=6$  may be used. The yield strength of the material can be expressed in terms of  $k$  and  $n$ :

$$\sigma_y = k \varepsilon^n = k (\varepsilon_{yp} + \bar{\varepsilon}^p)^n$$

where  $\epsilon_{yp}$  is the elastic strain to yield and  $\bar{\epsilon}^p$  is the effective plastic strain (logarithmic). If SIGY is set to zero, the strain to yield is found by solving for the intersection of the linearly elastic loading equation with the strain hardening equation:

$$\sigma = E \epsilon$$

$$\sigma = k \epsilon^n$$

which gives the elastic strain at yield as:

$$\epsilon_{yp} = \left( \frac{E}{k} \right)^{\left[ \frac{1}{n-1} \right]}$$

If SIGY yield is nonzero and greater than 0.02 then:

$$\epsilon_{yp} = \left( \frac{\sigma_y}{k} \right)^{\left[ \frac{1}{n} \right]}$$

The other available hardening models include the Voce equation given by

$$\sigma_Y(\epsilon_p) = a - b e^{-c \epsilon_p},$$

the Gosh equation given by

$$\sigma_Y(\epsilon_p) = k(\epsilon_0 + \epsilon_p)^n - p,$$

and finally the Hockett-Sherby equation given by

$$\sigma_Y(\epsilon_p) = a - b e^{-c \epsilon_p^n}.$$

For the Gosh hardening law, the interpretation of the variable SPI is the same, i.e., if set to zero the strain at yield is determined implicitly from the intersection of the strain hardening equation with the linear elastic equation.

To include strain rate effects in the model we multiply the yield stress by a factor depending on the effective plastic strain rate. We use the Cowper-Symonds' model, hence the yield stress can be written

$$\sigma_Y(\epsilon_p, \dot{\epsilon}_p) = \sigma_Y^s(\epsilon_p) \left\{ 1 + \left( \frac{\dot{\epsilon}_p}{C} \right)^{1/p} \right\}$$

where  $\sigma_Y^s$  denotes the static yield stress,  $C$  and  $p$  are material parameters,  $\dot{\epsilon}_p$  is the effective plastic strain rate.

5. A kinematic hardening model is implemented following the works of Chaboche and Roussilier. A back stress  $\alpha$  is introduced such that the effective stress is computed as

$$\sigma_{\text{eff}} = \sigma_{\text{eff}}(\sigma_{11} - 2\alpha_{11} - \alpha_{22}, \sigma_{22} - 2\alpha_{22} - \alpha_{11}, \sigma_{12} - \alpha_{12})$$

The back stress is the sum of up to four terms according to

$$\alpha_{ij} = \sum_{k=1}^4 \alpha_{ij}^k$$

and the evolution of each back stress component is as follows

$$\delta\alpha_{ij}^k = C_k \left( a_k \frac{s_{ij}}{\sigma_{\text{eff}}} - \alpha_{ij}^k \right) \delta\varepsilon_p$$

where  $C_k$  and  $a_k$  are material parameters,  $s_{ij}$  is the deviatoric stress tensor,  $\sigma_{\text{eff}}$  is the effective stress and  $\varepsilon_p$  is the effective plastic strain.

6. When the option `_NLP` is used, a necking failure criterion is activated to account for the non-linear strain path effect in sheet metal forming. Based on the traditional Forming Limit Diagram (FLD) for the linear strain path, the Formability Index (F.I.) is calculated for every element in the model throughout the simulation duration and the entire history is stored in history variable #9 in D3PLOT files, accessible from *Post/History* menu in LS-PrePost v3.1. The time history of the index can be plotted for each element under the menu. It is therefore necessary to set NEIPS to 10, in the second field of card 1 in keyword `*DATABASE_EXTENT_BINARY`, to output the history variable to the D3PLOT files. The index can also be plotted as a color contour map on the formed sheet blank, accessible from *Post/FriComp/Misc* menu. The index has a value ranging from 0.0 to 1.2, with the onset of necking failure at 1.0. The F.I. is calculated based on critical effect strain method, as illustrated in the Figure in **Remarks** in \*MAT\_037. The theoretical background can be found in two papers also referenced in **Remarks** section in \*MAT\_037.
7. When using the D3PLOT file to plot the history variable #9 (the F.I.) in color contour, the value in the “*Max*” pull-down menu in *Post/FriComp* needs to be set to “*Min*”, meaning that the necking failure occurs only when all integration points through the thickness have reached the critical value of 1.0. It is suggested to set the variable ‘MAXINT’ in `*DATABASE_EXTENT_BINDARY` to the same value as the variable ‘NIP’ in `*SECTION_SHELL`. In addition, the value in the “*Avg*” pull-down menu in *Post/FriRang* needs to be set to “None”. The strain path history (major vs. minor strain) of each element can be plotted with radial dial button *Strain Path* in *Post/FLD*.
8. An example of a partial input for the material is provided below, where the FLD for the linear strain path is defined by the variable NLP with load curve ID 211, where abscissa values represent minor strains and ordinate values represent major strains.

```

*MAT_3-PARAMETER_BARLAT_NLP
$-----1-----2-----3-----4-----5-----6-----7-----8
$      MID          RO          E          PR          HR          P1          P2          ITER
      1 2.890E-09  6.900E04  0.330  3.000
$      M          R00          R45          R90          LCID          E0          SPI          P3
      8.000  0.800  0.600  0.550  99
$      AOPT          C          P          VLCID
      2.000
$
$              A1          A2          A3
$      V1          V2          V3          D1          D2          D3          BETA

$-----1-----2-----3-----4-----5-----6-----7-----8
$ Hardening Curve
*DEFINE_CURVE
  99
      0.000          130.000
      0.002          134.400
      0.006          143.000
      0.010          151.300
      0.014          159.300
      ...
      0.900          365.000
      1.000          365.000
$ FLD Definition
*DEFINE_CURVE
  211
      -0.2          0.325
      -0.1054          0.2955
      -0.0513          0.2585
      0.0000          0.2054
      0.0488          0.2240
      0.0953          0.2396
      0.1398          0.2523
      0.1823          0.2622
      ...
  
```

9. The following FLD prediction of non-linear strain paths for a single element was done using this new option, for an Aluminum alloy with  $r_{00}=0.8$ ,  $r_{45}=0.6$ ,  $r_{90}=0.55$ , and yield at 130.0 MPa. In each case, the element is further strained in three different paths (uniaxial - U.A., plane strain - P.S., and equi-biaxial - E.B.) separately, following a pre-straining in uniaxial, plane strain and equi-biaxial. The forming limits are determined at the end of the further straining for each path, when the F.I. has reached the value of 1.0.

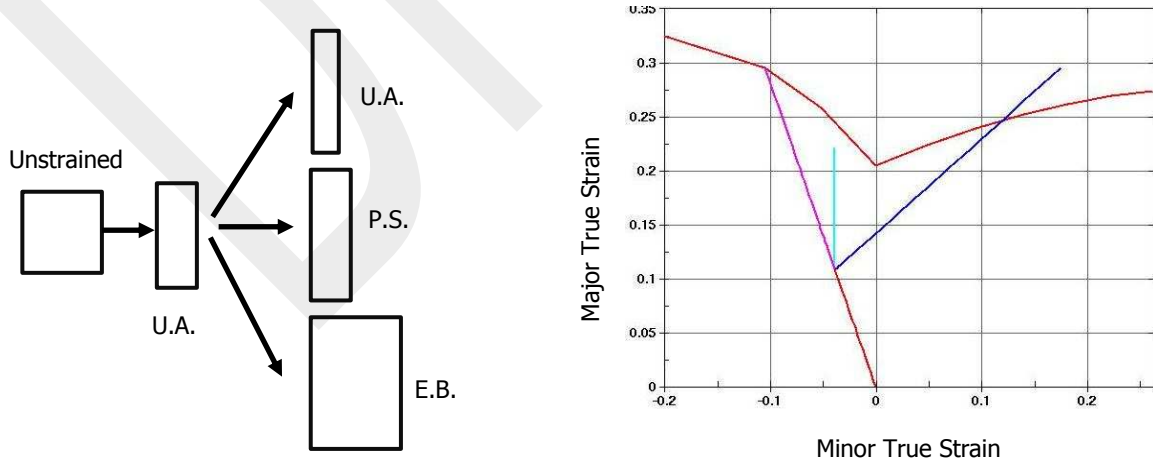

Nonlinear FLD prediction with pre-straining in uniaxial



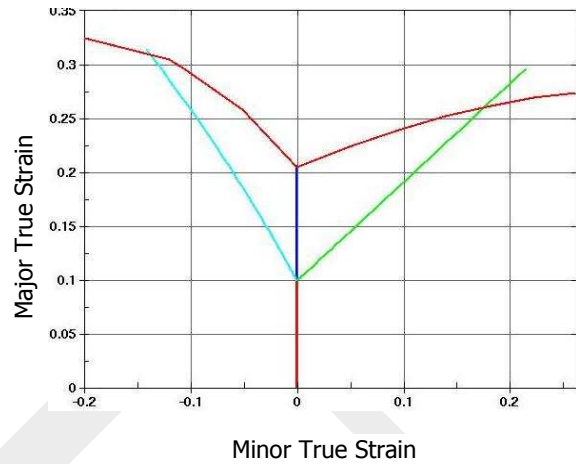
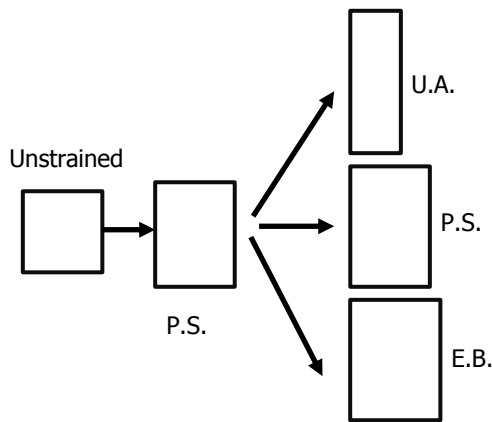

Nonlinear FLD prediction with pre-straining in plane strain

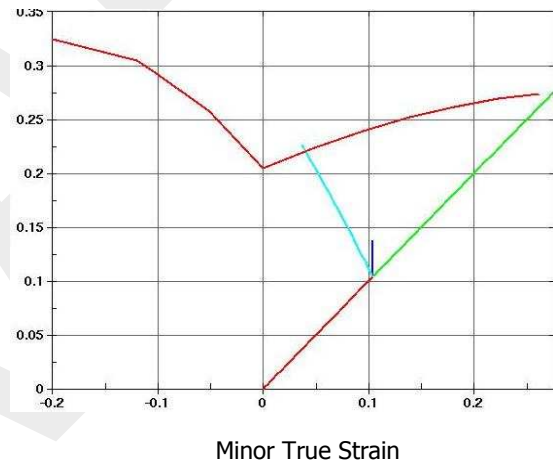
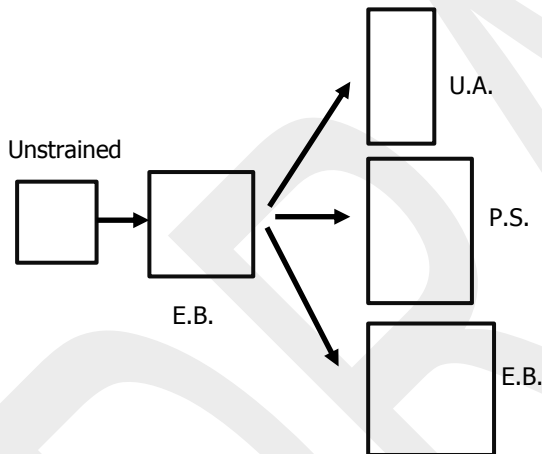

Nonlinear FLD prediction with pre-straining in equi-biaxial mode

10. Typically, to assess sheet formability, F.I. contour of the entire part can be plotted. Based on the contour plot, non-linear strain path and the F.I. time history of a few elements in the area of concern can be plotted for further study. These plots are similar to those shown in manual pages of \*MAT\_037.
11. The option `_NLP` is implemented for Explicit Dynamic analysis and is available pending a release soon.
12. Heat treatment for increasing the formability of prestrained aluminum sheets can be simulated through the use of HTFLAG, where the intention is to run a forming simulation in steps involving preforming, springback, heat treatment and postforming. In each step the history is transferred to the next via the use of `dynain` (see \*INTERFACE\_SPRINGBACK). The first two steps are performed with HTFLAG=0

according to standard procedures, resulting in a plastic strain field  $\varepsilon_p^0$  corresponding to the prestrain. The heat treatment step is performed using HTFLAG=1 in a coupled thermomechanical simulation, where the blank is heated. The coupling between thermal and mechanical is only that the maximum temperature  $T^0$  is stored as a history variable in the material model, this corresponding to the heat treatment temperature. Here it is important to export all history variables to the dynein file for the postforming step. In the final postforming step, HTFLAG=2, the yield stress is then augmented by the Hockett-Sherby like term

$$\Delta\sigma = b - (b - a) \exp\left(-c[\varepsilon_p - \varepsilon_p^0]^d\right)$$

where  $a$ ,  $b$ ,  $c$  and  $d$  are given as tables as functions of the heat treatment temperature  $T^0$  and prestrain  $\varepsilon_p^0$ . That is, in the table definitions each load curve corresponds to a given prestrain and the load curve value is with respect to the heat treatment temperature,

$$a = a(T^0, \varepsilon_p^0) \quad b = b(T^0, \varepsilon_p^0) \quad c = c(T^0, \varepsilon_p^0) \quad d = d(T^0, \varepsilon_p^0)$$

The effect of heat treatment is that the material strength decreases but hardening increases, thus typically

$$a \leq 0 \quad b \geq a \quad c > 0 \quad d > 0$$

**\*MAT\_TRANSVERSELY\_ANISOTROPIC\_ELASTIC\_PLASTIC\_{OPTION}**

Available option allows the change of Young’s Modulus during the simulation:

**<BLANK>**

**ECHANGE**

A new option is available to allow for the calculation of the Formability Index (F.I.) which accounts for sheet metal forming problems with non-linear strain path:

**NLP\_FAILURE**

This is Material Type 37. This model is for simulating sheet forming processes with anisotropic material. Only transverse anisotropy can be considered. Optionally an arbitrary dependency of stress and effective plastic strain can be defined via a load curve. This plasticity model is fully iterative and is available only for shell elements. Also see the notes below.

Card 1            1            2            3            4            5            6            7            8

Variable	MID	RO	E	PR	SIGY	ETAN	R	HLCID
Type	A	F	F	F	F	F	F	F

**Define the following card if option ECHANGE or NLP\_FAILURE is used,**

Optional        1            2            3            4            5            6            7            8

Variable	IDSCALE	EA	COE	ICFLD		STRAINLT		
Type	I	F	F	F		F		

<u>VARIABLE</u>	<u>DESCRIPTION</u>
MID	Material identification. A unique number or label not exceeding 8 characters must be specified.
RO	Mass density.
E	Young’s modulus.
PR	Poisson’s ratio.
SIGY	Yield stress.

<b>VARIABLE</b>	<b>DESCRIPTION</b>
ETAN	Plastic hardening modulus.
R	Anisotropic hardening parameter.
HLCID	Load curve ID defining effective yield stress versus effective plastic strain.
IDSCALE	Load curve ID defining the scale factor for the Young's modulus change with respect to effective strain (if EA and COE are defined), this curve is not necessary).
EA, COE	Coefficients defining the Young's modulus with respect to the effective strain, EA is $E^A$ and Coe is $\zeta$ (if IDSCALE is defined, these two parameters are not necessary).
ICFLD	Load curve ID for Forming Limit Diagram (FLD) definition.
STRAINLT	Critical strain value at which strain averaging is activated

**Remarks:**

1. Consider Cartesian reference axes which are parallel to the three symmetry planes of anisotropic behavior. Then, the yield function suggested by Hill [1948] can be written

$$F(\sigma_{22} - \sigma_{33})^2 + G(\sigma_{33} - \sigma_{11})^2 + H(\sigma_{11} - \sigma_{22})^2 + 2L\sigma_{23}^2 + 2M\sigma_{31}^2 + 2N\sigma_{12}^2 - 1 = 0$$

where  $\sigma_{y1}$ ,  $\sigma_{y2}$ , and  $\sigma_{y3}$ , are the tensile yield stresses and  $\sigma_{y12}$ ,  $\sigma_{y23}$ , and  $\sigma_{y31}$  are the shear yield stresses. The constants F, G H, L, M, and N are related to the yield stress by

$$2L = \frac{1}{\sigma_{y23}^2}$$

$$2M = \frac{1}{\sigma_{y31}^2}$$

$$2N = \frac{1}{\sigma_{y12}^2}$$

$$2F = \frac{1}{\sigma_{y2}^2} + \frac{1}{\sigma_{y3}^2} - \frac{1}{\sigma_{y1}^2}$$

$$2G = \frac{1}{\sigma_{y3}^2} + \frac{1}{\sigma_{y1}^2} - \frac{1}{\sigma_{y2}^2}$$

$$2H = \frac{1}{\sigma_{y1}^2} + \frac{1}{\sigma_{y2}^2} - \frac{1}{\sigma_{y3}^2}$$

The isotropic case of von Mises plasticity can be recovered by setting  $F = G = H = \frac{1}{2\sigma_y^2}$

and

$$L = M = N = \frac{3}{2\sigma_y^2}$$

For the particular case of transverse anisotropy, where properties do not vary in the  $x_1$ - $x_2$  plane, the following relations hold:

$$2F = 2G = \frac{1}{\sigma_{y3}^2}$$

$$2H = \frac{2}{\sigma_y^2} - \frac{1}{\sigma_{y3}^2}$$

$$N = \frac{2}{\sigma_y^2} - \frac{1}{2} \frac{1}{\sigma_{y3}^2}$$

where it has been assumed that  $\sigma_{y1} = \sigma_{y2} = \sigma_y$ .

Letting  $K = \frac{\sigma_y}{\sigma_{y3}}$ , the yield criteria can be written

$$F(\sigma) = \sigma_e = \sigma_y,$$

where

$$F(\sigma) \equiv \left[ \sigma_{11}^2 + \sigma_{22}^2 + K^2 \sigma_{33}^2 - K^2 \sigma_{33} (\sigma_{11} + \sigma_{22}) - (2 - K^2) \sigma_{11} \sigma_{22} + 2L\sigma_y^2 (\sigma_{23}^2 + \sigma_{31}^2) + 2 \left( 2 - \frac{1}{2} K^2 \right) \sigma_{12}^2 \right]^{1/2}$$

The rate of plastic strain is assumed to be normal to the yield surface so  $\dot{\epsilon}_{ij}^p$  is found from

$$\dot{\epsilon}_{ij}^p = \lambda \frac{\partial F}{\partial \sigma_{ij}}.$$

Now consider the case of plane stress, where  $\sigma_{33} = 0$ . Also, define the anisotropy input parameter,  $R$ , as the ratio of the in-plane plastic strain rate to the out-of-plane plastic strain rate,

$$R = \frac{\dot{\epsilon}_{22}^p}{\dot{\epsilon}_{33}^p}.$$

It then follows that

$$R = \frac{2}{K^2} - 1.$$

Using the plane stress assumption and the definition of  $R$ , the yield function may now be written

$$F(\sigma) = \left[ \sigma_{11}^2 + \sigma_{22}^2 - \frac{2R}{R+1} \sigma_{11} \sigma_{22} + 2 \frac{2R+1}{R+1} \sigma_{12}^2 \right]^{1/2}.$$

Note that there are several differences between this model and other plasticity models for shell elements such as the model, `MAT_PIECEWISE_LINEAR_PLASTICITY`. First, the yield function for plane stress does not include the transverse shear stress components which are updated elastically, and, secondly, this model is always fully iterative. Consequently, in comparing results for the isotropic case where  $R=1.0$  with other isotropic model, differences in the results are expected, even though they are usually insignificant.

The Young's modulus has been assumed to be constant. Recently, some researchers have found that Young's modulus decreases with respect to the increase of effective strain. To accommodate this new observation, a new option of `_ECHANGE` is added. There are two methods defining the change of Young's modulus change:

The first method is to use a curve to define the scale factor with respect to the effective strain. The value of this scale factor should decrease from 1 to 0 with the increase of effective strain.

The second method is to use a function as proposed by Yoshida [2003]:

$$E = E^0 - (E^0 - E^A)(1 - \exp(-\zeta \bar{\epsilon})).$$

2. When option `_NLP_FAULURE` is used, a necking failure criterion independent of strain path changes is activated. In sheet metal forming, as strain path history (plotted on in-plane major and minor strain space) of an element becomes non-linear, the position and shape of a traditional strain-based Forming Limit Diagram (FLD) changes. This option provides a simple formability index (F.I.) which remains invariant regardless of the presence of the non-linear strain path, and can be used to identify if the element has reached its necking limit.

3. Formability index (F.I) is calculated, as illustrated in the following figure, for every element throughout the simulation duration. The value of F.I. is 0.0 for virgin material and reaches maximum of 1.0 when the material fails. The theoretical background can be found in two papers: 1) T.B. Stoughton, X. Zhu, "Review of Theoretical Models of the Strain-Based FLD and their Relevance to the Stress-Based FLD, International Journal of Plasticity", V. 20, Issues 8-9,

P. 1463-1486, 2003; and 2) Danielle Zeng, Xinhai Zhu, Laurent B. Chappuis, Z. Cedric Xia, "A Path Independent Forming Limited Criterion for Sheet Metal Forming Simulations", 2008 SAE Proceedings, Detroit MI, April, 2008.

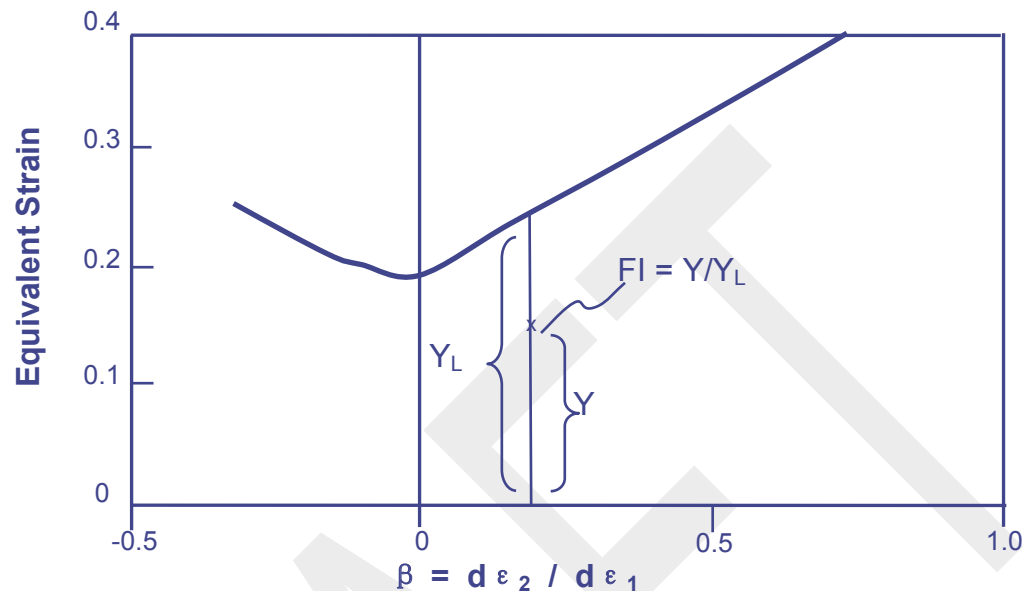

Calculation of FI based on critical effective strain method

4. Load curve input for FLD (ICFLD) follows keyword format in \*DEFINE\_CURVE, with abscissa values as minor strains and ordinate values as major strains.
5. Input of FLD can also be done using keyword \*DEFINE\_CURVE\_FLC, where sheet metal thickness and strain hardening value 'n' are used. Detailed usage information can be found in the manual pages describing the keyword.
6. The formability index is output as a history variable #1 in D3PLOT files. It is activated by setting NEIPS to 1, in the second field of card 1 in keyword \*DATABASE\_EXTENT\_BINARY. The history variable can be plotted in LS-PrePost, accessible in *FCOMP* (page 1), under 'Fringe Component' *MISC*.
7. When plotting the formability index, use the pull-down menu to select minimum value 'Min' under *FCOMP* for necking failure determination. In *RANGE* (page 1), select option *None* in the pull-down menu next to *Avg*. The index has a default range between 0.0 and 1.0. The non-linear forming limit is reached when the index reaches 1.0.
8. In addition, the evolution of the index throughout the simulation can be plotted in LS-PrePost under *HISTORY* (page 1) by *Element*, using the scroll bar to roll down the bottom to select *history var#1*. Furthermore, the strain path of an element can be plotted in FLD (page 1), using option *Tracer*, by selecting corresponding integration point representing the 'Min' index value in the *Position* pull-down menu.





Time = 0.1587, #nodes=476931  
Contours of History Variable#1  
min ipt. value  
min=0, at elem# 305  
max=1, at elem# 8887

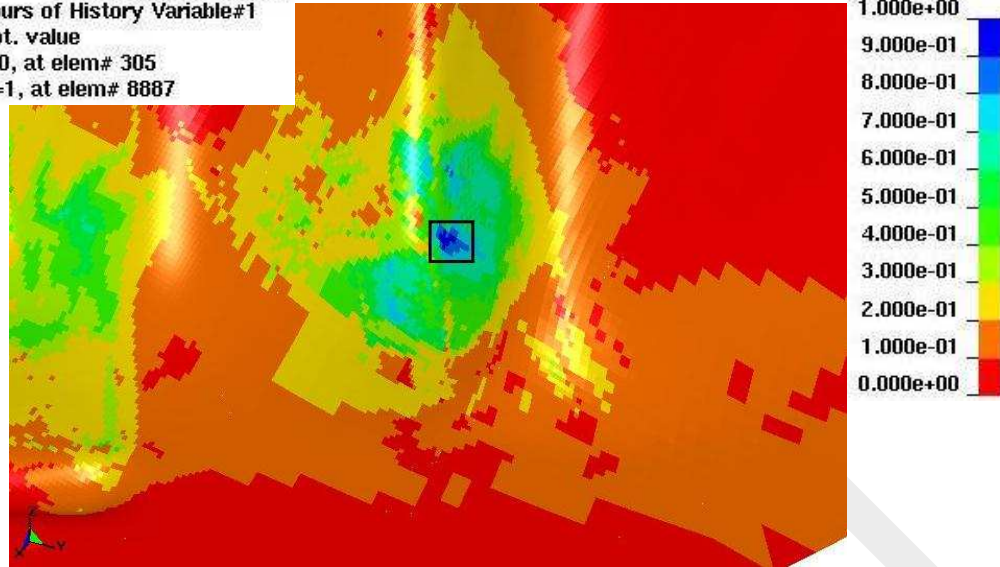

F.I. contour plot (min IP value, non-averaged)

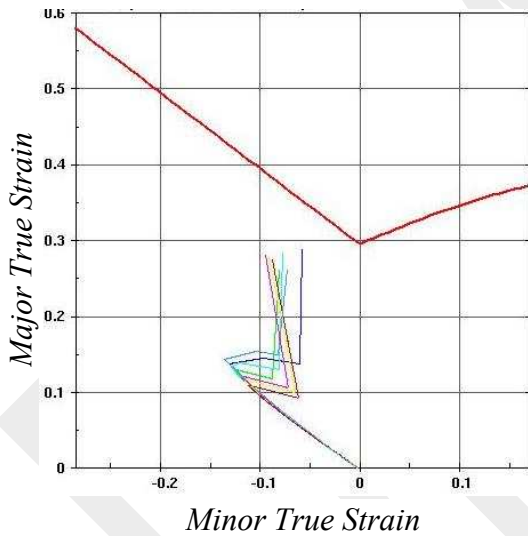

Non-linear Strain Path

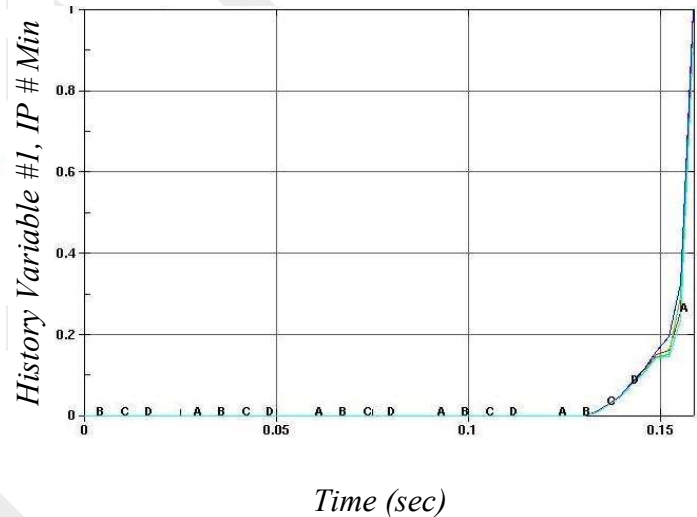

F.I. time history plot

13. The NLP\_FAILURE option is currently implemented in Explicit Dynamic and is available in LS-DYNA R5 Revision 60925 and later releases.

**\*MAT\_BLATZ-KO\_FOAM**

This is Material Type 38. This model is for the definition of rubber like foams of polyurethane. It is a simple one-parameter model with a fixed Poisson's ratio of .25.

Card 1	1	2	3	4	5	6	7	8
Variable	MID	RO	G	REF				
Type	A8	F	F	F				

<u>VARIABLE</u>	<u>DESCRIPTION</u>
MID	Material identification. A unique number or label not exceeding 8 characters must be specified.
RO	Mass density.
G	Shear modulus.
REF	Use reference geometry to initialize the stress tensor. The reference geometry is defined by the keyword:*INITIAL_FOAM_REFERENCE_GEOMETRY (see there for more details). EQ.0.0: off, EQ.1.0: on.

**Remarks:**

The strain energy functional for the compressible foam model is given by

$$W = \frac{G}{2} \left( \frac{II}{III} + 2\sqrt{III} - 5 \right)$$

Blatz and Ko [1962] suggested this form for a 47 percent volume polyurethane foam rubber with a Poisson's ratio of 0.25. In terms of the strain invariants, I, II, and III, the second Piola-Kirchhoff stresses are given as

$$S^{ij} = G \left[ \left( I\delta_{ij} - C_{ij} \right) \frac{1}{III} + \left( \sqrt{III} - \frac{II}{III} \right) C_{ij}^{-1} \right]$$

where  $C_{ij}$  is the right Cauchy-Green strain tensor. This stress measure is transformed to the Cauchy stress,  $\sigma_{ij}$ , according to the relationship

$$\sigma^{ij} = III^{-1/2} F_{ik} F_{jl} S_{lk}$$

where  $F_{ij}$  is the deformation gradient tensor.

DRAFT

**\*MAT\_FLD\_TRANSVERSELY\_ANISOTROPIC**

This is Material Type 39. This model is for simulating sheet forming processes with anisotropic material. Only transverse anisotropy can be considered. Optionally, an arbitrary dependency of stress and effective plastic strain can be defined via a load curve. A Forming Limit Diagram (FLD) can be defined using a curve and is used to compute the maximum strain ratio which can be plotted in LS-PrePost. This plasticity model is fully iterative and is available only for shell elements. Also see the notes below.

Card 1            1            2            3            4            5            6            7            8

Variable	MID	RO	E	PR	SIGY	ETAN	R	HLCID
Type	A8	F	F	F	F	F	F	F

Card 2            1            2            3            4            5            6            7            8

Variable	LCIDFLD							
Type	F							

<u>VARIABLE</u>	<u>DESCRIPTION</u>
MID	Material identification. A unique number or label not exceeding 8 characters must be specified.
RO	Mass density.
E	Young's modulus.
PR	Poisson's ratio.
SIGY	Yield stress.
ETAN	Plastic hardening modulus, see notes for model 37.
R	Anisotropic hardening parameter, see notes for model 37.
HLCID	Load curve ID defining effective stress versus effective plastic strain. The yield stress and hardening modulus are ignored with this option.

VARIABLE	DESCRIPTION
LCIDFLD	Load curve ID defining the Forming Limit Diagram. Minor strains in percent are defined as abscissa values and Major strains in percent are defined as ordinate values. The forming limit diagram is shown in Figure 39.1. In defining the curve list pairs of minor and major strains starting with the left most point and ending with the right most point, see *DEFINE_CURVE.

**Remarks:**

See material model 37 for the theoretical basis. The first history variable is the maximum strain ratio defined by:

$$\frac{\epsilon_{major\_workpiece}}{\epsilon_{major\_fld}}$$

corresponding to  $\epsilon_{minor\_workpiece}$ .

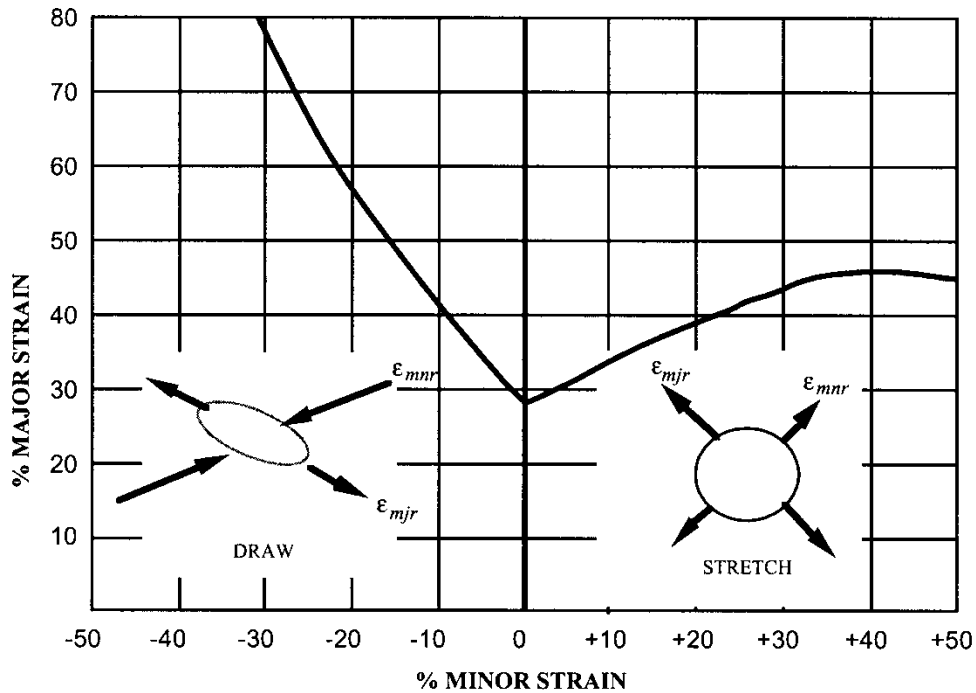
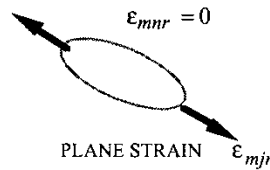

Figure 39.1. Forming Limit Diagram.

**\*MAT\_NONLINEAR\_ORTHOTROPIC**

This is Material Type 40. This model allows the definition of an orthotropic nonlinear elastic material based on a finite strain formulation with the initial geometry as the reference. Failure is optional with two failure criteria available. Optionally, stiffness proportional damping can be defined. In the stress initialization phase, temperatures can be varied to impose the initial stresses. This model is only available for shell and solid elements. We do not recommend using this model at this time since it can be unstable especially if the stress-strain curves increase in stiffness with increasing strain.

Card 1            1            2            3            4            5            6            7            8

Variable	MID	RO	EA	EB	EC	PRBA	PRCA	PRCB
Type	A8	F	F	F	F	F	F	F
Default	none	none	none	none	none	none	none	none

Card 2            1            2            3            4            5            6            7            8

Variable	GAB	GBC	GCA	DT	TRAMP	ALPHA		
Type	F	F	F	F	F	F		
Default	None	none	none	0	0	0		

Card 3            1            2            3            4            5            6            7            8

Variable	LCIDA	LCIDB	EFAIL	DFAIL	CDAMP	AOPT	MACF	
Type	F	F	F	F	F	F	I	
Default	0.0	0.0	0.0	0.0	0.0	0.0	0	

Card 4            1            2            3            4            5            6            7            8

Variable	XP	YP	ZP	A1	A2	A3		
Type	F	F	F	F	F	F		

Card 5            1            2            3            4            5            6            7            8

Variable	V1	V2	V3	D1	D2	D3	BETA	
Type	F	F	F	F	F	F	F	

**Optional Card 6 (Applies to Solid elements only)**

Card 6            1            2            3            4            5            6            7            8

Variable	LCIDC	LCIDAB	LCIDBC	LCIDCA				
Type	F	F	F	F				
Default	optional	optional	optional	optional				

**VARIABLE**

**DESCRIPTION**

MID	Material identification. A unique number or label not exceeding 8 characters must be specified.
RO	Mass density.
EA	$E_a$ , Young's modulus in a-direction.
EB	$E_b$ , Young's modulus in b-direction.
EC	$E_c$ , Young's modulus in c-direction.
PRBA	$\nu_{ba}$ , Poisson's ratio ba.
PRCA	$\nu_{ca}$ , Poisson's ratio ca.

<b>VARIABLE</b>	<b>DESCRIPTION</b>
PRCB	$\nu_{cb}$ , Poisson's ratio cb.
GAB	$G_{ab}$ , shear modulus ab.
GBC	$G_{bc}$ , shear modulus bc.
GCA	$G_{ca}$ , shear modulus ca.
DT	Temperature increment for isotropic stress initialization. This option can be used during dynamic relaxation.
TRAMP	Time to ramp up to the final temperature.
ALPHA	Thermal expansion coefficient.
LCIDA	Optional load curve ID defining the nominal stress versus strain along a-axis. Strain is defined as $\lambda_a - 1$ where $\lambda_a$ is the stretch ratio along the a axis.
LCIDB	Optional load curve ID defining the nominal stress versus strain along b-axis. Strain is defined as $\lambda_b - 1$ where $\lambda_b$ is the stretch ratio along the b axis.
EFAIL	Failure strain, $\lambda - 1$ .
DFAIL	Time step for automatic element erosion
CDAMP	Damping coefficient.



VARIABLE	DESCRIPTION
AOPT	<p>Material axes option (see <i>MAT_OPTION TROPIC_ELASTIC</i> for a more complete description):</p> <p>EQ.0.0: locally orthotropic with material axes determined by element nodes as shown in Figure 2.1. Nodes 1, 2, and 4 of an element are identical to the nodes used for the definition of a coordinate system as by <i>*DEFINE_COORDINATE_NODES</i>, and then, for shells only, rotated about the shell element normal by an angle BETA.</p> <p>EQ.1.0: locally orthotropic with material axes determined by a point in space and the global location of the element center; this is the a-direction. This option is for solid elements only.</p> <p>EQ.2.0: globally orthotropic with material axes determined by vectors defined below, as with <i>*DEFINE_COORDINATE_VECTOR</i>.</p> <p>EQ.3.0: locally orthotropic material axes determined by rotating the material axes about the element normal by an angle, BETA, from a line in the plane of the element defined by the cross product of the vector <b>v</b> with the element normal. The plane of a solid element is the midsurface between the inner surface and outer surface defined by the first four nodes and the last four nodes of the connectivity of the element, respectively.</p> <p>EQ.4.0: locally orthotropic in cylindrical coordinate system with the material axes determined by a vector <b>v</b>, and an originating point, <b>P</b>, which define the centerline axis. This option is for solid elements only.</p> <p>LT.0.0: the absolute value of AOPT is a coordinate system ID number (CID on <i>*DEFINE_COORDINATE_NODES</i>, <i>*DEFINE_COORDINATE_SYSTEM</i> or <i>*DEFINE_COORDINATE_VECTOR</i>). Available in R3 version of 971 and later.</p>
MACF	<p>Material axes change flag:</p> <p>EQ.1: No change, default,</p> <p>EQ.2: switch material axes a and b,</p> <p>EQ.3: switch material axes a and c,</p> <p>EQ.4: switch material axes b and c.</p>
XP YP ZP	Define coordinates of point <b>p</b> for AOPT = 1 and 4.
A1,A2,A3	<b>a</b> <sub>1</sub> <b>a</b> <sub>2</sub> <b>a</b> <sub>3</sub> , define components of vector <b>a</b> for AOPT = 2.
D1,D2,D3	<b>d</b> <sub>1</sub> <b>d</b> <sub>2</sub> <b>d</b> <sub>3</sub> , define components of vector <b>d</b> for AOPT = 2.
V1,V2,V3	<b>v</b> <sub>1</sub> <b>v</b> <sub>2</sub> <b>v</b> <sub>3</sub> , define components of vector <b>v</b> for AOPT = 3 and 4.

<u>VARIABLE</u>	<u>DESCRIPTION</u>
BETA	Material angle in degrees for AOPT = 0 (shells only) and 3. BETA may be overridden on the element card, see *ELEMENT_SHELL_BETA and *ELEMENT_SOLID_ORTHO..

**The following input is optional and applies to SOLID ELEMENTS only**

LCIDC	Load curve ID defining the nominal stress versus strain along c-axis. Strain is defined as $\lambda_c - 1$ where $\lambda_c$ is the stretch ratio along the c axis.
LCIDAB	Load curve ID defining the nominal ab shear stress versus ab-strain in the ab-plane. Strain is defined as the $\sin(\gamma_{ab})$ where $\gamma_{ab}$ is the shear angle.
LCIDBC	Load curve ID defining the nominal ab shear stress versus ab-strain in the bc-plane. Strain is defined as the $\sin(\gamma_{bc})$ where $\gamma_{bc}$ is the shear angle.
LCIDCA	Load curve ID defining the nominal ab shear stress versus ab-strain in the ca-plane. Strain is defined as the $\sin(\gamma_{ca})$ where $\gamma_{bc}$ is the shear angle.

\*MAT\_USER\_DEFINED\_MATERIAL\_MODELS

These are Material Types 41-50. The user must provide a material subroutine. See also Appendix A. This keyword input is used to define material properties for the subroutine. Isotropic, anisotropic, thermal, and hyperelastic material models with failure can be handled.

Card 1            1            2            3            4            5            6            7            8

Variable	MID	RO	MT	LMC	NHV	IORTHO/ ISPOT	IBULK	IG
Type	A8	F	I	I	I	I	I	I

Card 2            1            2            3            4            5            6            7            8

Variable	IVECT	IFAIL	ITHERM	IHYPER	IEOS	LMCA		
Type	I	I	I	I	I	I		

**Define the following two cards if and only if IORTHO=1**

Card 3            1            2            3            4            5            6            7            8

Variable	AOPT	MACF	XP	YP	ZP	A1	A2	A3
Type	F	I	F	F	F	F	F	F

Card 4            1            2            3            4            5            6            7            8

Variable	V1	V2	V3	D1	D2	D3	BETA	
Type	F	F	F	F	F	F	F	

**Define LMC material parameters using 8 parameters per card.**

Card            1            2            3            4            5            6            7            8

Variable	P1	P2	P3	P4	P5	P6	P7	P8
Type	F	F	F	F	F	F	F	F

**Define LMCA material parameters using 8 parameters per card.**

Card            1            2            3            4            5            6            7            8

Variable	P1	P2	P3	P4	P5	P6	P7	P8
Type	F	F	F	F	F	F	F	F

<u>VARIABLE</u>	<u>DESCRIPTION</u>
MID	Material identification. A unique number or label not exceeding 8 characters must be specified.
RO	Mass density.
MT	User material type (41-50 inclusive). A number between 41 and 50 has to be chosen.
LMC	Length of material constant array which is equal to the number of material constants to be input. (see remark 4)
NHV	Number of history variables to be stored, see Appendix A. When the model is to be used with an equation of state, NHV must be increased by 4 to allocate the storage required by the equation of state.
IORTHO/ISPOT	EQ. 1: if the material is orthotropic. EQ. 2: if material is used with spot weld thinning.
IBULK	Address of bulk modulus in material constants array, see Appendix A.
IG	Address of shear modulus in material constants array, see Appendix A.
IVECT	Vectorization flag (on=1). A vectorized user subroutine must be supplied.

VARIABLE	DESCRIPTION
IFAIL	Failure flag. EQ.0: No failure, EQ.1: Allows failure of shell and solid elements, LT.0:  IFAIL  is the address of NUMINT in the material constants array. NUMINT is defined as the number of failed integration points that will trigger element deletion. This option applies only to shell and solid elements (release 5 of v.971).
ITHERM	Temperature flag (on=1). Compute element temperature.
IHYPER	Deformation gradient flag (on=1 or -1). Compute deformation gradient, see Appendix A.
IEOS	Equation of state (on=1).
LMCA	Length of additional material constant array.
AOPT	Material axes option (see *MAT_002 for a more complete description): EQ.0.0: locally orthotropic with material axes determined by element nodes 1, 2, and 4, as with *DEFINE_COORDINATE_NODES, and then, for shells only, rotated about the shell element normal by an angle BETA. EQ.1.0: locally orthotropic with material axes determined by a point in space and the global location of the element center; this is the a-direction. This option is for solid elements only. EQ.2.0: globally orthotropic with material axes determined by vectors defined below, as with *DEFINE_COORDINATE_VECTOR. EQ.3.0: locally orthotropic material axes determined by rotating the material axes about the element normal by an angle, BETA, from a line in the plane of the element defined by the cross product of the vector <b>v</b> with the element normal. EQ.4.0: locally orthotropic in cylindrical coordinate system with the material axes determined by a vector <b>v</b> , and an originating point, <b>P</b> , which define the centerline axis. This option is for solid elements only. LT.0.0: the absolute value of AOPT is a coordinate system ID number (CID on *DEFINE_COORDINATE_NODES, *DEFINE_COORDINATE_SYSTEM or *DEFINE_COORDINATE_VECTOR). Available in R3 version of 971 and later.
MACF	Material axes change flag for brick elements for quick changes: EQ.1: No change, default, EQ.2: switch material axes a and b, EQ.3: switch material axes a and c, EQ.4: switch material axes b and c.

<u>VARIABLE</u>	<u>DESCRIPTION</u>
XP YP ZP	Coordinates of point <b>p</b> for AOPT = 1.
A1 A2 A3	Components of vector <b>a</b> for AOPT = 2.
V1 V2 V3	Components of vector <b>v</b> for AOPT = 3.
D1 D2 D3	Components of vector <b>d</b> for AOPT = 2.
BETA	Material angle in degrees for AOPT = 0 (shells only) and 3. BETA may be overridden on the element card, see *ELEMENT_SHELL_BETA and *ELEMENT_SOLID_ORTHO.
P1	First material parameter.
P2	Second material parameter.
P3	Third material parameter.
P4	Fourth material parameter.
.	.
PLMC	LMCth material parameter.

**Remarks:**

1. The material model for the cohesive element (solid element type 19) uses the first two material parameters to set flags for the element formulation. P1 controls how the density is used to calculate the mass. The cohesive element formulation permits the element to have zero or negative volume. Tractions are calculated on a surface midway between the surfaces defined by nodes 1-2-3-4 and 5-6-7-8. If P1 is set to 1.0, then the density is per unit area of the midsurface instead of per unit volume. The second parameter, P2, specifies the number of integration points (one to four) that are required to fail for the element to fail. If it is zero, the element won't fail regardless of the value of IFAIL. The recommended value of P2 is 1.
2. The cohesive element currently only uses MID, RO, MT, LMC, NHV, IFAIL and IVECT in addition to the material parameters.
3. See Appendix R for the specifics of the umat subroutine requirements for the cohesive element.
4. If IORTHO=0, LMC must be  $\leq 48$ . If IORTHO=1, LMC must be  $\leq 40$ . If more material constants are needed, LMCA may be used to create an additional material constant array. There is no limit on the size of LMCA.

5. If the user-defined material is used for beam or brick element spot welds that are tied to shell elements, and SPOTHIN>0 on \*CONTROL\_CONTACT, then spot weld thinning will be done for those shells if ISPOT=2. Otherwise, it will not be done.

DRAFT

**\*MAT\_BAMMAN**

This is Material Type 51. It allows the modeling of temperature and rate dependent plasticity with a fairly complex model that has many input parameters [Bamman 1989].

Card 1            1            2            3            4            5            6            7            8

Variable	MID	RO	E	PR	T	HC		
Type	A8	F	F	F	F	F		

Card 2            1            2            3            4            5            6            7            8

Variable	C1	C2	C3	C4	C5	C6	C7	C8
Type	F	F	F	F	F	F	F	F

Card 3            1            2            3            4            5            6            7            8

Variable	C9	C10	C11	C12	C13	C14	C15	C16
Type	F	F	F	F	F	F	F	F

Card 4            1            2            3            4            5            6            7            8

Variable	C17	C18	A1	A2	A4	A5	A6	KAPPA
Type	F	F	F	F	F	F	F	F

**VARIABLE****DESCRIPTION**

MID	Material identification. A unique number or label not exceeding 8 characters must be specified.
RO	Mass density.



<u>VARIABLE</u>	<u>DESCRIPTION</u>
E	Young's modulus (psi)
PR	Poisson's ratio
T	Initial temperature (°R)
HC	Heat generation coefficient (°R/psi)
C1	Psi
C2	°R
C3	Psi
C4	°R
C5	1/s
C6	oR
C7	1/psi
C8	oR
C9	Psi
C10	°R
C11	1/psi-s
C12	oR
C13	1/psi
C14	oR
C15	psi
C16	°R
C17	1/psi-s
C18	oR
A1	$\alpha_1$ , initial value of internal state variable 1

<u>VARIABLE</u>	<u>DESCRIPTION</u>
A2	$\alpha_2$ , initial value of internal state variable 2. (Note: $\alpha_3 = -(\alpha_1 + \alpha_2)$ )
A3	$\alpha_4$ , initial value of internal state variable 3
A4	$\alpha_5$ , initial value of internal state variable 4
A5	$\alpha_6$ , initial value of internal state variable 5
KAPPA	$\kappa$ , initial value of internal state variable 6

	sec-psi-°R	sec-MPa-°R	sec-MPA-°K
C1		*1/145	*1/145
C2		—	*5/9
C3		*1/145	*1/145
C4		—	*5/9
C5		—	—
C6		—	*5/9
C7		*145	*145
C8		—	*5/9
C9		*1/145	*1/145
C10		—	*5/9
C11		*145	*145
C12		—	*5/9
C13		*145	*145
C14		—	*5/9
C15		*1/145	*1/145
C16		—	*5/9
C17		*145	*145
C18		—	*5/9
C0=HC		*145	*145*5/9
E		*1/145	*1/145
ν		—	—
T		—	*5/9

**Remarks:**

The kinematics associated with the model are discussed in references [Hill 1948, Bammann and Aifantis 1987, Bammann 1989]. The description below is taken nearly verbatim from Bammann [1989].

With the assumption of linear elasticity we can write,

$$\overset{\circ}{\sigma} = \lambda \operatorname{tr}(D^e)1 + 2\mu D^e$$

where the Cauchy stress  $\sigma$  is convected with the elastic spin  $W^e$  as,

$$\overset{\circ}{\sigma} = \dot{\sigma} - W^e \sigma + \sigma W^e$$

This is equivalent to writing the constitutive model with respect to a set of directors whose direction is defined by the plastic deformation [Bammann and Aifantis 1987, Bammann and Johnson 1987]. Decomposing both the skew symmetric and symmetric parts of the velocity gradient into elastic and plastic parts we write for the elastic stretching  $D^e$  and the elastic spin  $W^e$ ,

$$D^e = D - D^p - D^{th}, \quad W^e = W = W^p.$$

Within this structure it is now necessary to prescribe an equation for the plastic spin  $W^p$  in addition to the normally prescribed flow rule for  $D^p$  and the stretching due to the thermal expansion  $D^{th}$ . As proposed, we assume a flow rule of the form,

$$D^p = f(T) \sinh \left[ \frac{|\xi| - \kappa - Y(T)}{V(T)} \right] \frac{\xi'}{|\xi'|}.$$

where  $T$  is the temperature,  $\kappa$  is the scalar hardening variable, and  $\xi'$  is the difference between the deviatoric Cauchy stress  $\sigma'$  and the tensor variable  $\alpha'$ ,

$$\xi' = \sigma' - \alpha'$$

and  $f(T)$ ,  $Y(T)$ ,  $V(T)$  are scalar functions whose specific dependence upon the temperature is given below. Assuming isotropic thermal expansion and introducing the expansion coefficient  $\dot{A}$ , the thermal stretching can be written,

$$D^{th} = \dot{A} \dot{T} 1$$

The evolution of the internal variables  $\alpha$  and  $\kappa$  are prescribed in a hardening minus recovery format as,

$$\begin{aligned} \overset{\circ}{\alpha} &= h(T) D^p - [r_d(T) |D^p| + r_s(T)] |\alpha| \alpha, \\ \dot{\kappa} &= H(T) D^p - [R_d(T) |D^p| + R_s(T)] \kappa^2 \end{aligned}$$

where  $h$  and  $H$  are the hardening moduli,  $r_s(T)$  and  $R_s(T)$  are scalar functions describing the diffusion controlled 'static' or 'thermal' recovery, and  $r_d(T)$  and  $R_d(T)$  are the functions describing dynamic recovery.

If we assume that  $W^p = 0$ , we recover the Jaumann stress rate which results in the prediction of an oscillatory shear stress response in simple shear when coupled with a Prager kinematic hardening assumption [Johnson and Bammann 1984]. Alternatively we can choose,

$$W^p = R^T \dot{U} U^{-1} R,$$

which recovers the Green-Naghdi rate of Cauchy stress and has been shown to be equivalent to Mandel’s isoclinic state [Bammann and Aifantis 1987]. The model employing this rate allows a reasonable prediction of directional softening for some materials, but in general under-predicts the softening and does not accurately predict the axial stresses which occur in the torsion of the thin walled tube.

The final equation necessary to complete our description of high strain rate deformation is one which allows us to compute the temperature change during the deformation. In the absence of a coupled thermo-mechanical finite element code we assume adiabatic temperature change and follow the empirical assumption that 90 -95% of the plastic work is dissipated as heat. Hence,

$$\dot{T} = \frac{.9}{\rho C_v} (\sigma \cdot D^p),$$

where  $\rho$  is the density of the material and  $C_v$  the specific heat.

In terms of the input parameters the functions defined above become:

$V(T) = C1 \exp(-C2/T)$	$h(T) = C9 \exp(C10/T)$
$Y(T) = C3 \exp(C4/T)$	$rs(T) = C11 \exp(-C12/T)$
$f(T) = C5 \exp(-C6/T)$	$RD(T) = C13 \exp(-C14/T)$
$rd(T) = C7 \exp(-C8/T)$	$H(T) = C15 \exp(C16/T)$
	$RS(T) = C17 \exp(-C18/T)$

and the heat generation coefficient is

$$HC = \frac{.9}{\rho C_v}.$$

\*MAT\_BAMMAN\_DAMAGE

This is Material Type 52. This is an extension of model 51 which includes the modeling of damage. See Bamman et al. [1990].

Card 1            1            2            3            4            5            6            7            8

Variable	MID	RO	E	PR	T	HC		
Type	A8	F	F	F	F	F		

Card 2            1            2            3            4            5            6            7            8

Variable	C1	C2	C3	C4	C5	C6	C7	C8
Type	F	F	F	F	F	F	F	F

Card 3            1            2            3            4            5            6            7            8

Variable	C9	C10	C11	C12	C13	C14	C15	C16
Type	F	F	F	F	F	F	F	F

Card 4            1            2            3            4            5            6            7            8

Variable	C17	C18	A1	A2	A3	A4	A5	A6
Type	F	F	F	F	F	F	F	F

Card 5            1            2            3            4            5            6            7            8

Variable	N	D0	FS					
Type	F	F	F					

<u>VARIABLE</u>	<u>DESCRIPTION</u>
MID	Material identification. A unique number or label not exceeding 8 characters must be specified.
RO	Mass density
E	Young's modulus (psi)
PR	Poisson's ratio
T	Initial temperature (°R)
HC	Heat generation coefficient (°R/psi)
C1	Psi
C2	°R
C3	Psi
C4	°R
C5	1/s
C6	oR
C7	1/psi
C8	oR
C9	Psi
C10	°R
C11	1/psi-s
C12	oR

VARIABLE	DESCRIPTION
C13	1/psi
C14	oR
C15	psi
C16	oR
C17	1/psi-s
C18	oR
A1	$\alpha_1$ , initial value of internal state variable 1
A2	$\alpha_2$ , initial value of internal state variable 2
A3	$\alpha_3$ , initial value of internal state variable 3
A4	$\alpha_4$ , initial value of internal state variable 4
A5	$\alpha_5$ , initial value of internal state variable 5
A6	$\alpha_6$ , initial value of internal state variable 6
N	Exponent in damage evolution
D0	Initial damage (porosity)
FS	Failure strain for erosion.

**Remarks:**

The evolution of the damage parameter,  $\phi$  is defined by Bammann et al. [1990]

$$\dot{\phi} = \beta \left[ \frac{1}{(1-\phi)^N} - (1-\phi) \right]^{D^p}$$

in which

$$\beta = \sinh \left[ \frac{2(2N-1)p}{(2N-1)\bar{\sigma}} \right]$$

where  $p$  is the pressure and  $\bar{\sigma}$  is the effective stress.

**\*MAT\_CLOSED\_CELL\_FOAM**

This is Material Type 53. This allows the modeling of low density, closed cell polyurethane foam. It is for simulating impact limiters in automotive applications. The effect of the confined air pressure is included with the air being treated as an ideal gas. The general behavior is isotropic with uncoupled components of the stress tensor.

Card 1            1            2            3            4            5            6            7            8

Variable	MID	RO	E	A	B	C	P0	PHI
Type	A8	F	F	F	F	F	F	F

Card 2            1            2            3            4            5            6            7            8

Variable	GAMA0	LCID						
Type	F	I						

<u>VARIABLE</u>	<u>DESCRIPTION</u>
MID	Material identification. A unique number or label not exceeding 8 characters must be specified.
RO	Mass density
E	Young's modulus
A	a, factor for yield stress definition, see notes below.
B	b, factor for yield stress definition, see notes below.
C	c, factor for yield stress definition, see notes below.
P0	Initial foam pressure, P <sub>0</sub>
PHI	Ratio of foam to polymer density, $\phi$
GAMA0	Initial volumetric strain, $\gamma_0$ . The default is zero.



VARIABLE	DESCRIPTION
LCID	Optional load curve defining the von Mises yield stress versus $-\gamma$ . If the load curve ID is given, the yield stress is taken from the curve and the constants a, b, and c are not needed. The load curve is defined in the positive quadrant, i.e., positive values of $\gamma$ are defined as negative values on the abscissa.

### Remarks:

A rigid, low density, closed cell, polyurethane foam model developed at Sandia Laboratories [Nielsen, Morgan and Krieg 1987] has been recently implemented for modeling impact limiters in automotive applications. A number of such foams were tested at Sandia and reasonable fits to the experimental data were obtained.

In some respects this model is similar to the crushable honeycomb model type 26 in that the components of the stress tensor are uncoupled until full volumetric compaction is achieved. However, unlike the honeycomb model this material possesses no directionality but includes the effects of confined air pressure in its overall response characteristics.

$$\sigma_{ij} = \sigma_{ij}^{sk} - \delta_{ij} \sigma^{air}$$

where  $\sigma_{ij}^{sk}$  is the skeletal stress and  $\sigma^{air}$  is the air pressure computed from the equation:

$$\sigma^{air} = -\frac{p_0 \gamma}{1 + \gamma - \phi}$$

where  $p_0$  is the initial foam pressure, usually taken as the atmospheric pressure, and  $\gamma$  defines the volumetric strain

$$\gamma = V - 1 + \gamma_0$$

where V is the relative volume, defined as the ratio of the current volume to the initial volume, and  $\gamma_0$  is the initial volumetric strain, which is typically zero. The yield condition is applied to the principal skeletal stresses, which are updated independently of the air pressure. We first obtain the skeletal stresses:

$$\sigma_{ij}^{sk} = \sigma_{ij} + \delta_{ij} \sigma^{air}$$

and compute the trial stress,  $\sigma^{skt}$

$$\sigma_{ij}^{skt} = \sigma_{ij}^{sk} + E \dot{\epsilon}_{ij} \Delta t$$

where E is Young's modulus. Since Poisson's ratio is zero, the update of each stress component is uncoupled and  $2G=E$  where G is the shear modulus. The yield condition is applied to the principal skeletal stresses such that, if the magnitude of a principal trial stress component,  $\sigma_i^{skt}$ , exceeds the yield stress,  $\sigma_y$ , then

$$\sigma_i^{sk} = \min\left(\sigma_y, |\sigma_i^{skt}|\right) \frac{\sigma_i^{skt}}{|\sigma_i^{skt}|}$$

The yield stress is defined by

$$\sigma_y = a + b(1 + c\gamma)$$

where a, b, and c are user defined input constants and  $\gamma$  is the volumetric strain as defined above. After scaling the principal stresses they are transformed back into the global system and the final stress state is computed

$$\sigma_{ij} = \sigma_{ij}^{sk} - \delta_{ij} \sigma^{air}$$

\*MAT\_ENHANCED\_COMPOSITE\_DAMAGE

These are Material Types 54-55 which are enhanced versions of the composite model material type 22. Arbitrary orthotropic materials, e.g., unidirectional layers in composite shell structures can be defined. Optionally, various types of failure can be specified following either the suggestions of [Chang and Chang 1987b] or [Tsai and Wu 1971]. In addition special measures are taken for failure under compression. See [Matzenmiller and Schweizerhof 1991]. This model is only valid for thin shell elements. The parameters in parentheses below apply only to solid elements and are therefore always ignored in this material model. They are included for consistency with material types 22 and 59. By using the user defined integration rule, see \*INTEGRATION\_SHELL, the constitutive constants can vary through the shell thickness. For all shells, except the DKT formulation, laminated shell theory can be activated to properly model the transverse shear deformation. Lamination theory is applied to correct for the assumption of a uniform constant shear strain through the thickness of the shell. For sandwich shells where the outer layers are much stiffer than the inner layers, the response will tend to be too stiff unless lamination theory is used. To turn on lamination theory see \*CONTROL\_SHELL. A damage model for transverse shear strain is added since version 971 release R4 to model interlaminar shear failure. The definition of minimum stress limits is available since version 971 R5.

Card 1            1            2            3            4            5            6            7            8

Variable	MID	RO	EA	EB	(EC)	PRBA	PRCA	PRCB
Type	A8	F	F	F	F	F	F	F

Card 2            1            2            3            4            5            6            7            8

Variable	GAB	GBC	GCA	(KF)	AOPT			
Type	F	F	F	F	F			

Card 3            1            2            3            4            5            6            7            8

Variable				A1	A2	A3	MANGLE	
Type				F	F	F	F	

Card 4            1            2            3            4            5            6            7            8

Variable	V1	V2	V3	D1	D2	D3	DFAILM	DFAILS
Type	F	F	F	F	F	F	F	F

Card 5            1            2            3            4            5            6            7            8

Variable	TFAIL	ALPH	SOFT	FBRT	YCFAC	DFAULT	DFAILC	EFS
Type	F	F	F	F	F	F	F	F

Card 6            1            2            3            4            5            6            7            8

Variable	XC	XT	YC	YT	SC	CRIT	BETA	
Type	F	F	F	F	F	F	F	

**Optional Card 7 (starting with version 971 release R4)**

Card 7            1            2            3            4            5            6            7            8

Variable	PFL	EPSF	EPSR	TSMD	SOFT2			
Type	F	F	F	F	F			

**Optional Card 8 (starting with version 971 release R5)**

Card 8            1            2            3            4            5            6            7            8

Variable	SLIMT1	SLIMC1	SLIMT2	SLIMC2	SLIMS	NCYRED	SOFTG	
Type	F	F	F	F	F	F	F	

VARIABLE	DESCRIPTION
MID	Material identification. A unique number or label not exceeding 8 characters must be specified.
RO	Mass density
EA	$E_a$ , Young's modulus - longitudinal direction
EB	$E_b$ , Young's modulus - transverse direction
(EC)	$E_c$ , Young's modulus - normal direction (not used)
PRBA	$\nu_{ba}$ , Poisson's ratio ba
PRCA	$\nu_{ca}$ , Poisson's ratio ca
PRCB	$\nu_{cb}$ , Poisson's ratio cb
GAB	$G_{ab}$ , shear modulus ab
GBC	$G_{bc}$ , shear modulus bc
GCA	$G_{ca}$ , shear modulus ca
(KF)	Bulk modulus of failed material (not used)
AOPT	Material axes option (see <i>MAT_OPTION TROPIC_ELASTIC</i> for a more complete description): EQ.0.0: locally orthotropic with material axes determined by element nodes 1, 2, and 4, as with <i>*DEFINE_COORDINATE_NODES</i> , and then, for shells only, rotated about the shell element normal by an angle <i>MANGLE</i> . EQ.2.0: globally orthotropic with material axes determined by vectors defined below, as with <i>*DEFINE_COORDINATE_VECTOR</i> . EQ.3.0: locally orthotropic material axes determined by rotating the material axes about the element normal by an angle ( <i>MANGLE</i> ) from a line in the plane of the element defined by the cross product of the vector <i>v</i> with the element normal. LT.0.0: the absolute value of <i>AOPT</i> is a coordinate system ID number ( <i>CID</i> on <i>*DEFINE_COORDINATE_NODES</i> , <i>*DEFINE_COORDINATE_SYSTEM</i> or <i>*DEFINE_COORDINATE_VECTOR</i> ). Available in R3 version of 971 and later.
A1 A2 A3	Define components of vector <b>a</b> for <i>AOPT</i> = 2.
V1 V2 V3	Define components of vector <b>v</b> for <i>AOPT</i> = 3.

<b>VARIABLE</b>	<b>DESCRIPTION</b>
D1 D2 D3	Define components of vector <b>d</b> for AOPT = 2.
MANGLE	Material angle in degrees for AOPT = 0 (shells only) and 3. MANGLE may be overridden on the element card, see *ELEMENT_SHELL_BETA and *ELEMENT_SOLID_ORTHO. .
DFAILM	Maximum strain for matrix straining in tension or compression (active only for MAT_054 and only if DFAILT > 0). The layer in the element is completely removed after the maximum strain in the matrix direction is reached. The input value is always positive.
DFAILS	Maximum tensorial shear strain (active only for MAT_054 and only if DFAILT > 0). The layer in the element is completely removed after the maximum shear strain is reached. The input value is always positive.
TFAIL	Time step size criteria for element deletion: $\leq 0$ : no element deletion by time step size. The crashfront algorithm only works if $t_{fail}$ is set to a value above zero. $0 < t_{fail} \leq 0.1$ : element is deleted when its time step is smaller than the given value, $> .1$ : element is deleted when the quotient of the actual time step and the original time step drops below the given value.
ALPH	Shear stress parameter for the nonlinear term, see Material 22.
SOFT	Softening reduction factor for material strength in crashfront elements (default = 1.0). TFALL must be greater than zero to activate this option.
FBRT	Softening for fiber tensile strength: EQ.0.0: tensile strength = $X_t$ GT.0.0: tensile strength = $X_t$ , reduced to $X_t * FBRT$ after failure has occurred in compressive matrix mode.
YCFAC	Reduction factor for compressive fiber strength after matrix compressive failure (MAT_054 only). The compressive strength in the fiber direction after compressive matrix failure is reduced to: $X_c = YCFAC * Y_c$ (default : $YCFAC = 2.0$ )
DFAILT	Maximum strain for fiber tension (MAT_054 only). (Maximum 1 = 100% strain). The layer in the element is completely removed after the maximum tensile strain in the fiber direction is reached. If a nonzero value is given for DFAILT, a nonzero, negative value must also be provided for DFAILC.

VARIABLE	DESCRIPTION
DFAILC	Maximum strain for fiber compression (MAT_054 only). (Maximum -1 = 100% compression). The layer in the element is completely removed after the maximum compressive strain in the fiber direction is reached. The input value should be negative and is required if DFAILT > 0.
EFS	Effective failure strain (MAT_054 only).
XC	Longitudinal compressive strength (absolute value is used). GE.0.0: Poisson effect (PRBA) after failure is active. LT.0.0: Poisson effect after failure is not active, i.e. PRBA=0.
XT	Longitudinal tensile strength, see below.
YC	Transverse compressive strength, b-axis (positive value), see below.
YT	Transverse tensile strength, b-axis, see below.
SC	Shear strength, ab plane, see below.
CRIT	Failure criterion (material number): EQ.54.0: Chang matrix failure criterion (as Material 22) (default), EQ.55.0: Tsai-Wu criterion for matrix failure.
BETA	Weighting factor for shear term in tensile fiber mode (MAT_054 only). (0.0 ≤ BETA ≤ 1.0)
PFL	Percentage of layers which must fail until crashfront is initiated. E.g.  PFL =80.0, then 80 % of layers must fail until strengths are reduced in neighboring elements. Default: all layers must fail. A single layer fails if 1 in-plane IP fails (PFL>0) or if 4 in-plane IPs fail (PFL<0). (MAT_054 only).
EPSF	Damage initiation transverse shear strain. (MAT_054 only).
EPSR	Final rupture transverse shear strain. (MAT_054 only).
TSMC	Transverse shear maximum damage, default=0.90. (MAT_054 only).
SOFT2	Optional “orthogonal” softening reduction factor for material strength in crashfront elements (default = 1.0). See remarks.
SLIMT1	Factor to determine the minimum stress limit after stress maximum (fiber tension). Similar to *MAT_058.
SLIMC1	Factor to determine the minimum stress limit after stress maximum (fiber compression). Similar to *MAT_058.

<u>VARIABLE</u>	<u>DESCRIPTION</u>
SLIMT2	Factor to determine the minimum stress limit after stress maximum (matrix tension). Similar to *MAT_058.
SLIMT2	Factor to determine the minimum stress limit after stress maximum (matrix compression). Similar to *MAT_058.
SLIMS	Factor to determine the minimum stress limit after stress maximum (shear). Similar to *MAT_058.
NCYRED	Number of cycles for stress reduction from maximum to minimum.
SOFTG	Softening reduction factor for transverse shear moduli GBC and GCA in crashfront elements (default=1.0).

**Remarks:**

The Chang/Chang (mat\_54) criteria is given as follows:

for the tensile fiber mode,

$$\sigma_{aa} > 0 \text{ then } e_f^2 = \left(\frac{\sigma_{aa}}{X_t}\right)^2 + \beta \left(\frac{\sigma_{ab}}{S_c}\right)^2 - 1 \begin{cases} \geq 0 \text{ failed} \\ < 0 \text{ elastic} \end{cases}$$

$$E_a = E_b = G_{ab} = \nu_{ba} = \nu_{ab} = 0,$$

for the compressive fiber mode,

$$\sigma_{aa} < 0 \text{ then } e_c^2 = \left(\frac{\sigma_{aa}}{X_c}\right)^2 - 1 \begin{cases} \geq 0 \text{ failed} \\ < 0 \text{ elastic} \end{cases}$$

$$E_a = \nu_{ba} = \nu_{ab} = 0.$$

for the tensile matrix mode,

$$\sigma_{bb} > 0 \text{ then } e_m^2 = \left(\frac{\sigma_{bb}}{Y_t}\right)^2 + \left(\frac{\sigma_{ab}}{S_c}\right)^2 - 1 \begin{cases} \geq 0 \text{ failed} \\ < 0 \text{ elastic} \end{cases}$$

$$E_b = \nu_{ba} = 0. \rightarrow G_{ab} = 0,$$

and for the compressive matrix mode,

$$\sigma_{bb} < 0 \text{ then } e_d^2 = \left(\frac{\sigma_{bb}}{2S_c}\right)^2 + \left[\left(\frac{Y_c}{2S_c}\right)^2 - 1\right] \frac{\sigma_{bb}}{Y_c} + \left(\frac{\sigma_{ab}}{S_c}\right)^2 - 1 \begin{cases} \geq 0 \text{ failed} \\ < 0 \text{ elastic} \end{cases}$$



$$v_b = v_{ba} = v_{ab} = 0. \rightarrow G_{ab} = 0$$

$$X_c = 2Y_c \text{ for } 50\% \text{ fiber volume}$$

In the Tsai-Wu (MAT\_055) criteria the tensile and compressive fiber modes are treated as in the Chang-Chang criteria. The failure criterion for the tensile and compressive matrix mode is given as:

$$e_{md}^2 = \frac{\sigma_{bb}^2}{Y_c Y_t} + \left( \frac{\sigma_{ab}}{S_c} \right)^2 + \frac{(Y_c - Y_t) \sigma_{bb}}{Y_c Y_t} - 1 \begin{cases} \geq 0 & \text{failed} \\ < 0 & \text{elastic} \end{cases}$$

For  $\beta=1$  we get the original criterion of Hashin [1980] in the tensile fiber mode. For  $\beta=0$  we get the maximum stress criterion which is found to compare better to experiments.

In MAT\_054, failure can occur in any of four different ways:

1. If DFAILT is zero, failure occurs if the Chang-Chang failure criterion is satisfied in the tensile fiber mode.
2. If DFAILT is greater than zero, failure occurs if the tensile fiber strain is greater than DFAILT or less than DFAILC.
3. If EFS is greater than zero, failure occurs if the effective strain is greater than EFS.
4. If TFAIL is greater than zero, failure occurs according to the element timestep as described in the definition of TFAIL above.

When failure has occurred in all the composite layers (through-thickness integration points), the element is deleted. Elements which share nodes with the deleted element become “crashfront” elements and can have their strengths reduced by using the SOFT parameter with TFAIL greater than zero. An earlier initiation of crashfront elements is possible by using parameter PFL.

An optional direction dependent strength reduction can be invoked by setting  $0 < \text{SOFT2} < 1$ . Then, SOFT equals a strength reduction factor for fiber parallel failure and SOFT2 equals a strength reduction factor for fiber orthogonal failure. Linear interpolation is used for angles in between. See Figure 54.2.

Information about the status in each layer (integration point) and element can be plotted using additional integration point variables. The number of additional integration point variables for shells written to the LS-DYNA database is input by the \*DATABASE\_EXTENT\_BINARY definition as variable NEIPS. For Models 54 and 55 these additional variables are tabulated below ( $i$  = shell integration point):

History Variable	Description	Value	LS-Prepost history variable
1.ef(i)	tensile fiber mode	1 - elastic	1
2.ec(i)	compressive fiber mode		2

History Variable	Description	Value	LS-Prepost history variable
3. <i>em(i)</i>	<i>tensile matrix mode</i>	<i>0 - failed</i>	3
4. <i>ed(i)</i>	<i>compressive matrix mode</i>		4
5. <i>efail</i>	<i>max[ef(ip)]</i>		5
6. <i>dam</i>	<i>damage parameter</i>	<i>-1 - element intact 10<sup>-8</sup> - element in crashfront +1 - element failed</i>	6

These variables can be plotted in LS-Prepost element history variables 1 to 6. The following components, defined by the sum of failure indicators over all through-thickness integration points, are stored as element component 7 instead of the effective plastic strain.

Description	Integration point
$\frac{1}{nip} \sum_{i=1}^{nip} ef(i)$	1
$\frac{1}{nip} \sum_{i=1}^{nip} ec(i)$	2
$\frac{1}{nip} \sum_{i=1}^{nip} em(i)$	3

In an optional damage model for transverse shear strain, out-of-plane stiffness (GBC and GCA) can get linearly decreased to model interlaminar shear failure. Damage starts when effective transverse shear strain

$$\epsilon_{56}^{eff} = \sqrt{\epsilon_{yz}^2 + \epsilon_{zx}^2}$$

reaches EPSF. Final rupture occurs when effective transverse shear strain reaches EPSR. A maximum damage of TSMD (0.0<TSMD<0.99) cannot be exceeded. See Figure 54.1.

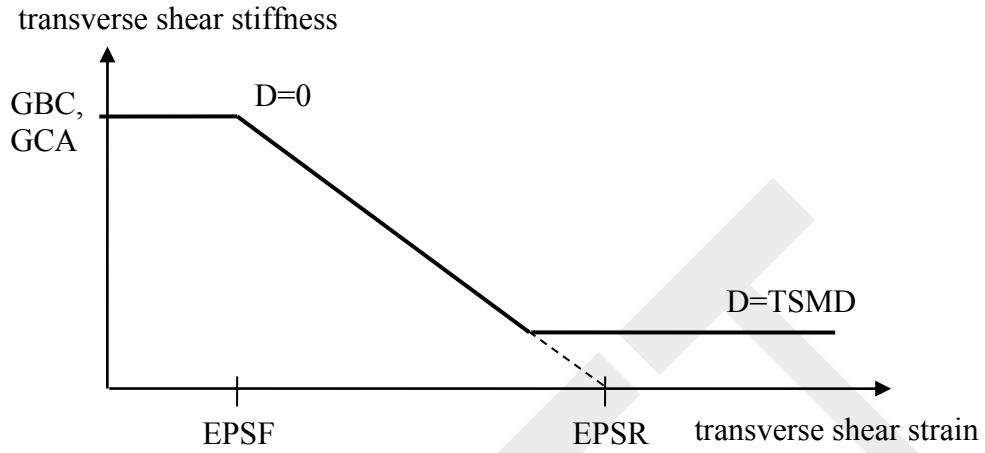

Figure 54.1 Linear damage for transverse shear behavior

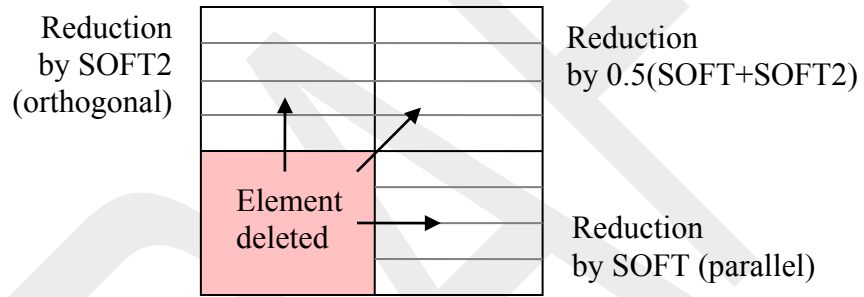

Figure 54.2 Direction dependent softening

**\*MAT\_LOW\_DENSITY\_FOAM**

This is Material Type 57 for modeling highly compressible low density foams. Its main applications are for seat cushions and padding on the Side Impact Dummies (SID). Optionally, a tension cut-off failure can be defined. A table can be defined if thermal effects are considered in the nominal stress versus strain behavior. Also, see the notes below.

Card 1            1            2            3            4            5            6            7            8

Variable	MID	RO	E	LCID	TC	HU	BETA	DAMP
Type	A8	F	F	F	F	F	F	F
Default					1.E+20	1.		0.05
Remarks						3	1	

Card 2            1            2            3            4            5            6            7            8

Variable	SHAPE	FAIL	BVFLAG	ED	BETA1	KCON	REF	
Type	F	F	F	F	F	F	F	
Default	1.0	0.0	0.0	0.0	0.0	0.0	0.0	
Remarks	3		2	5	5	6		

<u>VARIABLE</u>	<u>DESCRIPTION</u>
MID	Material identification. A unique number or label not exceeding 8 characters must be specified.
RO	Mass density
E	Young's modulus used in tension. For implicit problems E is set to the initial slope of load curve LCID.

VARIABLE	DESCRIPTION
LCID	Load curve or table ID, see *DEFINE_CURVE, for the nominal stress versus strain curve definition. If a table is used, a family of curves is defined each corresponding to a discrete temperature, see *DEFINE_TABLE.
TC	Tension cut-off stress
HU	Hysteretic unloading factor between 0 and 1 (default=1, i.e., no energy dissipation), see also Figure 57.1.
BETA	$\beta$ , decay constant to model creep in unloading
DAMP	Viscous coefficient (.05 < recommended value < .50) to model damping effects. LT.0.0:  DAMP  is the load curve ID, which defines the damping constant as a function of the maximum strain in compression defined as: $\varepsilon_{\max} = \max(1 - \lambda_1, 1 - \lambda_2, 1 - \lambda_3)$ In tension, the damping constant is set to the value corresponding to the strain at 0. The abscissa should be defined from 0 to 1.
SHAPE	Shape factor for unloading. Active for nonzero values of the hysteretic unloading factor. Values less than one reduces the energy dissipation and greater than one increases dissipation, see also Figure 57.1.
FAIL	Failure option after cutoff stress is reached: EQ.0.0: tensile stress remains at cut-off value, EQ.1.0: tensile stress is reset to zero.
BVFLAG	Bulk viscosity activation flag, see remark below: EQ.0.0: no bulk viscosity (recommended), EQ.1.0: bulk viscosity active.
ED	Optional Young's relaxation modulus, $E_d$ , for rate effects. See comments below.
BETA1	Optional decay constant, $\beta_1$ .
KCON	Stiffness coefficient for contact interface stiffness. If undefined the maximum slope in stress vs. strain curve is used. When the maximum slope is taken for the contact, the time step size for this material is reduced for stability. In some cases $\Delta t$ may be significantly smaller, and defining a reasonable stiffness is recommended.

VARIABLE	DESCRIPTION
REF	Use reference geometry to initialize the stress tensor. The reference geometry is defined by the keyword: *INITIAL_FOAM_REFERENCE_GEOMETRY (see there for more details). EQ.0.0: off, EQ.1.0: on.

**Remarks:**

The compressive behavior is illustrated in Figure 57.1 where hysteresis on unloading is shown. This behavior under uniaxial loading is assumed not to significantly couple in the transverse directions. In tension the material behaves in a linear fashion until tearing occurs. Although our implementation may be somewhat unusual, it was motivated by Storakers [1986].

The model uses tabulated input data for the loading curve where the nominal stresses are defined as a function of the elongations,  $\epsilon_i$ , which are defined in terms of the principal stretches,  $\lambda_i$ , as:

$$\epsilon_i = \lambda_i - 1$$

The stretch ratios are found by solving for the eigenvalues of the left stretch tensor,  $V_{ij}$ , which is obtained via a polar decomposition of the deformation gradient matrix,  $F_{ij}$ . Recall that,

$$F_{ij} = R_{ik}U_{kj} = V_{ik}R_{kj}$$

The update of  $V_{ij}$  follows the numerically stable approach of Taylor and Flanagan [1989]. After solving for the principal stretches, we compute the elongations and, if the elongations are compressive, the corresponding values of the nominal stresses,  $\tau_i$  are interpolated. If the elongations are tensile, the nominal stresses are given by

$$\tau_i = E\epsilon_i$$

and the Cauchy stresses in the principal system become

$$\sigma_i = \frac{\tau_i}{\lambda_j \lambda_k}$$

The stresses can now be transformed back into the global system for the nodal force calculations.

**Additional Remarks:**

- When hysteretic unloading is used the reloading will follow the unloading curve if the decay constant,  $\beta$ , is set to zero. If  $\beta$  is nonzero the decay to the original loading curve is governed by the expression:

$$1. - e^{-\beta t}$$

2. The bulk viscosity, which generates a rate dependent pressure, may cause an unexpected volumetric response and, consequently, it is optional with this model.
3. The hysteretic unloading factor results in the unloading curve to lie beneath the loading curve as shown in Figure 57.1. This unloading provides energy dissipation which is reasonable in certain kinds of foam.
4. Note that since this material has no effective plastic strain, the internal energy per initial volume is written into the output databases.
5. Rate effects are accounted for through linear viscoelasticity by a convolution integral of the form

$$\sigma_{ij}^r = \int_0^t g_{ijkl}(t-\tau) \frac{\partial \epsilon_{kl}}{\partial \tau} d\tau$$

where  $g_{ijkl}(t-\tau)$  is the relaxation function. The stress tensor,  $\sigma_{ij}^r$ , augments the stresses determined from the foam,  $\sigma_{ij}^f$ ; consequently, the final stress,  $\sigma_{ij}$ , is taken as the summation of the two contributions:

$$\sigma_{ij} = \sigma_{ij}^f + \sigma_{ij}^r.$$

Since we wish to include only simple rate effects, the relaxation function is represented by one term from the Prony series:

$$g(t) = \alpha_0 + \sum_{m=1}^N \alpha_m e^{-\beta t}$$

given by,

$$g(t) = E_d e^{-\beta_1 t}$$

This model is effectively a Maxwell fluid which consists of a damper and spring in series. We characterize this in the input by a Young's modulus,  $E_d$ , and decay constant,  $\beta_1$ . The formulation is performed in the local system of principal stretches where only the principal values of stress are computed and triaxial coupling is avoided. Consequently, the one-dimensional nature of this foam material is unaffected by this addition of rate effects. The addition of rate effects necessitates twelve additional history variables per integration point. The cost and memory overhead of this model comes primarily from the need to “remember” the local system of principal stretches.

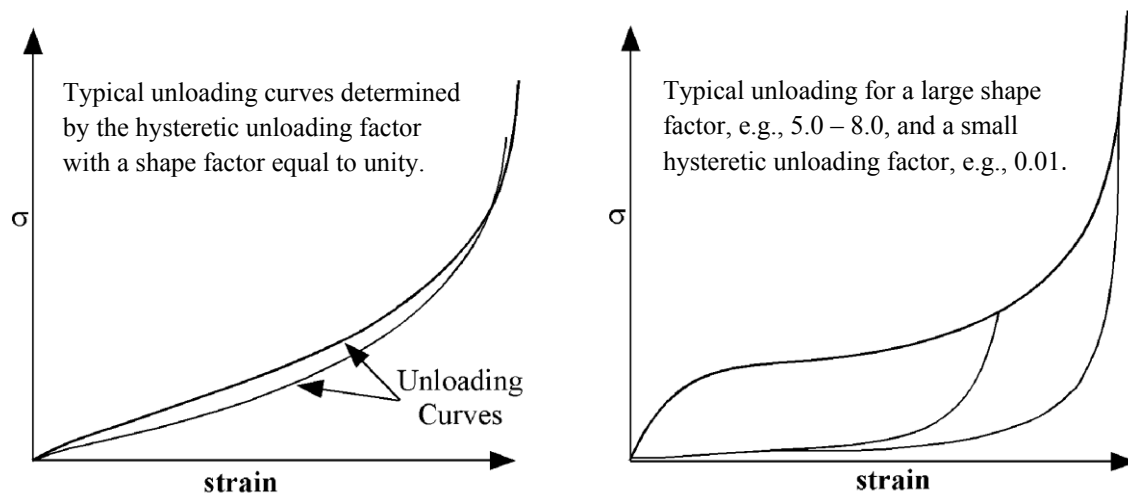

**Figure 57.1.** Behavior of the low density urethane foam model.

6. The time step size is based on the current density and the maximum of the instantaneous loading slope,  $E$ , and  $KCON$ . If  $KCON$  is undefined the maximum slope in the loading curve is used instead.



\*MAT\_LAMINATED\_COMPOSITE\_FABRIC

This is Material Type 58. Depending on the type of failure surface, this model may be used to model composite materials with unidirectional layers, complete laminates, and woven fabrics. This model is implemented for shell and thick shell elements.

Card 1            1            2            3            4            5            6            7            8

Variable	MID	RO	EA	EB	(EC)	PRBA	TAU1	GAMMA1
Type	A8	F	F	F	F	F	F	F

Card 2            1            2            3            4            5            6            7            8

Variable	GAB	GBC	GCA	SLIMT1	SLIMC1	SLIMT2	SLIMC2	SLIMS
Type	F	F	F	F	F	F	F	F

Card 3            1            2            3            4            5            6            7            8

Variable	AOPT	TSIZE	ERODS	SOFT	FS			
Type	F	F	F	F	F			

Card 4            1            2            3            4            5            6            7            8

Variable	XP	YP	ZP	A1	A2	A3		
Type	F	F	F	F	F	F		

Card 5            1            2            3            4            5            6            7            8

Variable	V1	V2	V3	D1	D2	D3	BETA	
Type	F	F	F	F	F	F	F	

Card 6            1            2            3            4            5            6            7            8

Variable	E11C	E11T	E22C	E22T	GMS			
Type	F	F	F	F	F			

Card 7            1            2            3            4            5            6            7            8

Variable	XC	XT	YC	YT	SC			
Type	F	F	F	F	F			

<u>VARIABLE</u>	<u>DESCRIPTION</u>
MID	Material identification. A unique number or label not exceeding 8 characters must be specified.
RO	Mass density
EA	$E_a$ , Young's modulus - longitudinal direction
EB	$E_b$ , Young's modulus - transverse direction
(EC)	$E_c$ , Young's modulus - normal direction (not used)
PRBA	$\nu_{ba}$ , Poisson's ratio ba
TAU1	$\tau_1$ , stress limit of the first slightly nonlinear part of the shear stress versus shear strain curve. The values $\tau_1$ and $\gamma_1$ are used to define a curve of shear stress versus shear strain. These values are input if FS, defined below, is set to a value of -1.

VARIABLE	DESCRIPTION
GAMMA1	$\gamma_1$ , strain limit of the first slightly nonlinear part of the shear stress versus engineering shear strain curve.
GAB	$G_{ab}$ , shear modulus ab
GBC	$G_{bc}$ , shear modulus bc
GCA	$G_{ca}$ , shear modulus ca
SLIMT1	Factor to determine the minimum stress limit after stress maximum (fiber tension).
SLIMC1	Factor to determine the minimum stress limit after stress maximum (fiber compression).
SLIMT2	Factor to determine the minimum stress limit after stress maximum (matrix tension).
SLIMC2	Factor to determine the minimum stress limit after stress maximum (matrix compression).
SLIMS	Factor to determine the minimum stress limit after stress maximum (shear).
AOPT	Material axes option (see <i>MAT_OPTION TROPIC_ELASTIC</i> for a more complete description): EQ. 0.0: locally orthotropic with material axes determined by element nodes 1, 2, and 4, as with <i>*DEFINE_COORDINATE_NODES</i> , and then rotated about the shell element normal by an angle BETA. EQ. 2.0: globally orthotropic with material axes determined by vectors defined below, as with <i>*DEFINE_COORDINATE_VECTOR</i> . EQ. 3.0: locally orthotropic material axes determined by rotating the material axes about the element normal by an angle (BETA) from a line in the plane of the element defined by the cross product of the vector $\mathbf{v}$ with the element normal. LT.0.0: the absolute value of AOPT is a coordinate system ID number (CID on <i>*DEFINE_COORDINATE_NODES</i> , <i>*DEFINE_COORDINATE_SYSTEM</i> or <i>*DEFINE_COORDINATE_VECTOR</i> ). Available in R3 version of 971 and later.
TSIZE	Time step for automatic element deletion.

VARIABLE	DESCRIPTION
ERODS	Maximum effective strain for element layer failure. A value of unity would equal 100% strain. GT.0.0: fails when effective strain calculated assuming material is volume preserving exceeds ERODS (old way). LT.0.0: fails when effective strain calculated from the full strain tensor exceeds  ERODS .
SOFT	Softening reduction factor for strength in the crashfront.
FS	Failure surface type: EQ.1.0: smooth failure surface with a quadratic criterion for both the fiber (a) and transverse (b) directions. This option can be used with complete laminates and fabrics. EQ.0.0: smooth failure surface in the transverse (b) direction with a limiting value in the fiber (a) direction. This model is appropriate for unidirectional (UD) layered composites only. EQ.-1.: faceted failure surface. When the strength values are reached then damage evolves in tension and compression for both the fiber and transverse direction. Shear behavior is also considered. This option can be used with complete laminates and fabrics.
XP YP ZP	Define coordinates of point <b>p</b> for AOPT = 1.
A1 A2 A3	Define components of vector <b>a</b> for AOPT = 2.
V1 V2 V3	Define components of vector <b>v</b> for AOPT = 3.
D1 D2 D3	Define components of vector <b>d</b> for AOPT = 2.
BETA	Material angle in degrees for AOPT=0 and 3, may be overridden on the element card, see *ELEMENT_SHELL_BETA.
E11C	Strain at longitudinal compressive strength, a-axis (positive).
E11T	Strain at longitudinal tensile strength, a-axis.
E22C	Strain at transverse compressive strength, b-axis.
E22T	Strain at transverse tensile strength, b-axis.
GMS	Engineering shear strain at shear strength, ab plane.
XC	Longitudinal compressive strength (positive value).
XT	Longitudinal tensile strength, see below.
YC	Transverse compressive strength, b-axis (positive value), see below.

<u>VARIABLE</u>	<u>DESCRIPTION</u>
YT	Transverse tensile strength, b-axis, see below.
SC	Shear strength, ab plane, see below.

**Remarks:**

Parameters to control failure of an element layer are: ERODS, the maximum effective strain, i.e., maximum 1 = 100 % straining. The layer in the element is completely removed after the maximum effective strain (compression/tension including shear) is reached.

The stress limits are factors used to limit the stress in the softening part to a given value,

$$\sigma_{\min} = SLIM_{xx} \cdot strength ,$$

thus, the damage value is slightly modified such that elastoplastic like behavior is achieved with the threshold stress. As a factor for *SLIM<sub>xx</sub>* a number between 0.0 and 1.0 is possible. With a factor of 1.0, the stress remains at a maximum value identical to the strength, which is similar to ideal elastoplastic behavior. For tensile failure a small value for *SLIM<sub>Tx</sub>* is often reasonable; however, for compression *SLIM<sub>Cx</sub>* = 1.0 is preferred. This is also valid for the corresponding shear value. If *SLIM<sub>xx</sub>* is smaller than 1.0 then localization can be observed depending on the total behavior of the lay-up. If the user is intentionally using *SLIM<sub>xx</sub>* < 1.0, it is generally recommended to avoid a drop to zero and set the value to something in between 0.05 and 0.10. Then elastoplastic behavior is achieved in the limit which often leads to less numerical problems. Defaults for *SLIM<sub>XX</sub>* = 1.0E-8.

The crashfront-algorithm is started if and only if a value for *TSIZE* (time step size, with element elimination after the actual time step becomes smaller than *TSIZE*) is input.

The damage parameters can be written to the postprocessing database for each integration point as the first three additional element variables and can be visualized.

Material models with *FS*=1 or *FS*=-1 are favorable for complete laminates and fabrics, as all directions are treated in a similar fashion.

For material model *FS*=1 an interaction between normal stresses and the shear stresses is assumed for the evolution of damage in the a and b-directions. For the shear damage is always the maximum value of the damage from the criterion in a or b-direction is taken.

For material model *FS*=-1 it is assumed that the damage evolution is independent of any of the other stresses. A coupling is only present via the elastic material parameters and the complete structure.

In tensile and compression directions and in a as well as in b- direction different failure surfaces can be assumed. The damage values, however, increase only also when the loading direction changes.

**Special control of shear behavior of fabrics**

For fabric materials a nonlinear stress strain curve for the shear part for failure surface FS=-1 can be assumed as given below. This is not possible for other values of FS.

The curve, shown in Figure 58.1 is defined by three points:

- a) the origin (0,0) is assumed,
- b) the limit of the first slightly nonlinear part (must be input), stress (TAU1) and strain (GAMMA1), see below.
- c) the shear strength at failure and shear strain at failure.

In addition a stress limiter can be used to keep the stress constant via the *SLIMS* parameter. This value must be less or equal 1.0 but positive, and leads to an elastoplastic behavior for the shear part. The default is 1.0E-08, assuming almost brittle failure once the strength limit SC is reached.

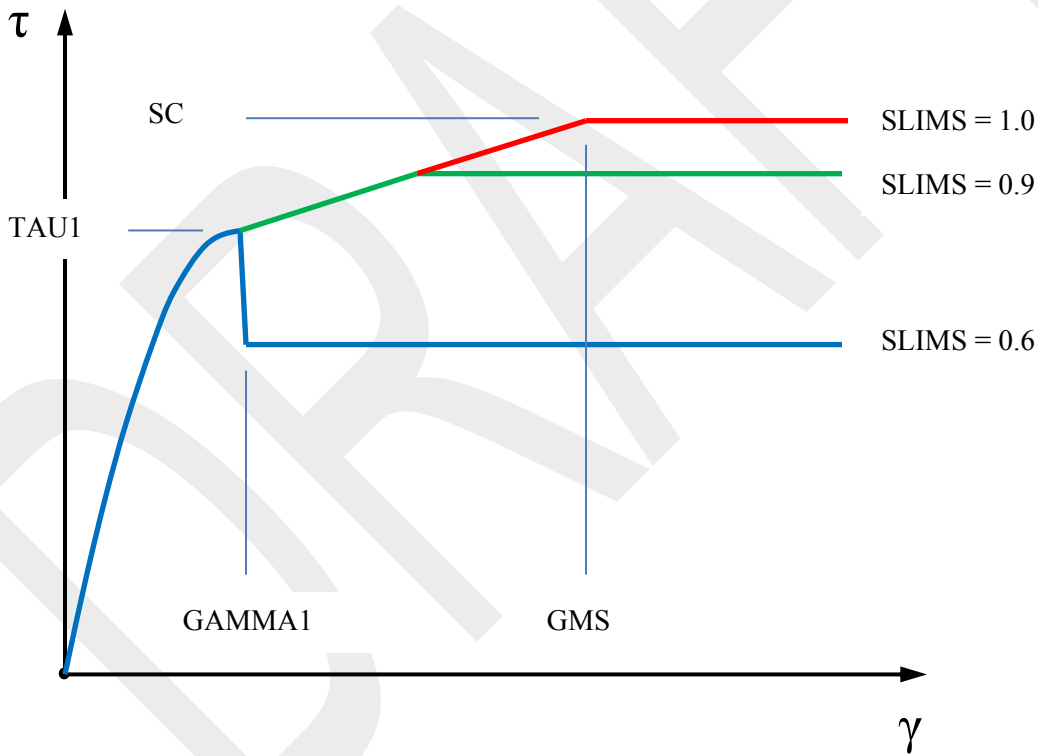

**Figure 58.1.** Stress-strain diagram for shear.

\*MAT\_COMPOSITE\_FAILURE\_{OPTION}\_MODEL

This is Material Type 59.

Available options include:

**SHELL**

**SOLID**

**SPH**

depending on the element type the material is to be used with, see \*PART.

**For both options define cards 1 to 4 below**

Card 1            1            2            3            4            5            6            7            8

Variable	MID	RO	EA	EB	EC	PRBA	PRCA	PRCB
Type	A8	F	F	F	F	F	F	F

Card 2            1            2            3            4            5            6            7            8

Variable	GAB	GBC	GCA	KF	AOPT	MACF		
Type	F	F	F	F	F	I		

Card 3            1            2            3            4            5            6            7            8

Variable	XP	YP	ZP	A1	A2	A3		
Type	F	F	F	F	F	F		

Card 4            1            2            3            4            5            6            7            8

Variable	V1	V2	V3	D1	D2	D3	BETA	
Type	F	F	F	F	F	F	F	

**Cards 5 and 6 for SHELL option**

Card 5            1            2            3            4            5            6            7            8

Variable	TSIZE	ALP	SOFT	FBRT	SR	SF		
Type	F	F	F	F	F	F		

Card 6            1            2            3            4            5            6            7            8

Variable	XC	XT	YC	YT	SC			
Type	F	F	F	F	F			

**Cards 5 and 6 for SOLID and SPH option**

Card 5            1            2            3            4            5            6            7            8

Variable	SBA	SCA	SCB	XXC	YYC	ZZC		
Type	F	F	F	F	F	F		

Card 6            1            2            3            4            5            6            7            8

Variable	XXT	YYT	ZZT					
Type	F	F	F					



<u>VARIABLE</u>	<u>DESCRIPTION</u>
MID	Material identification. A unique number or label not exceeding 8 characters must be specified.
RO	Density
EA	$E_a$ , Young's modulus - longitudinal direction
EB	$E_b$ , Young's modulus - transverse direction
EC	$E_c$ , Young's modulus - normal direction
PRBA	$\nu_{ba}$ Poisson's ratio ba
PRCA	$\nu_{ca}$ Poisson's ratio ca
PRCB	$\nu_{cb}$ Poisson's ratio cb
GAB	$G_{ab}$ Shear Modulus
GBC	$G_{bc}$ Shear Modulus
GCA	$G_{ca}$ Shear Modulus
KF	Bulk modulus of failed material

<u>VARIABLE</u>	<u>DESCRIPTION</u>
AOPT	<p>Material axes option (see MAT_OPTION TROPIC_ELASTIC for a more complete description):</p> <p>EQ.0.0: locally orthotropic with material axes determined by element nodes 1, 2, and 4, as with *DEFINE_COORDINATE_NODES, and then, for shells only, rotated about the shell element normal by an angle BETA.</p> <p>EQ.1.0: locally orthotropic with material axes determined by a point in space and the global location of the element center; this is the a-direction. This option is for solid elements only.</p> <p>EQ.2.0: globally orthotropic with material axes determined by vectors defined below, as with *DEFINE_COORDINATE_VECTOR.</p> <p>EQ.3.0: locally orthotropic material axes determined by rotating the material axes about the element normal by an angle, BETA, from a line in the plane of the element defined by the cross product of the vector <b>v</b> with the element normal.</p> <p>EQ.4.0: locally orthotropic in cylindrical coordinate system with the material axes determined by a vector <b>v</b>, and an originating point, <b>P</b>, which define the centerline axis. This option is for solid elements only.</p> <p>LT.0.0: the absolute value of AOPT is a coordinate system ID number (CID on *DEFINE_COORDINATE_NODES, *DEFINE_COORDINATE_SYSTEM or *DEFINE_COORDINATE_VECTOR). Available in R3 version of 971 and later.</p>
MACF	<p>Material axes change flag for brick elements.</p> <p>EQ.1: No change, default, EQ.2: switch material axes a and b, EQ.3: switch material axes a and c, EQ.4: switch material axes b and c.</p>
XP YP ZP	Define coordinates of point <b>p</b> for AOPT = 1 and 4.
A1 A2 A3	Define components of vector <b>a</b> for AOPT = 2.
V1 V2 V3	Define components of vector <b>v</b> for AOPT = 3 and 4.
D1 D2 D3	Define components of vector <b>d</b> for AOPT = 2:
BETA	Material angle in degrees for AOPT=0 (shells only) and AOPT=3, may be overridden on the element card, see *ELEMENT_SHELL_BETA or *ELEMENT_SOLID_ORTHO.
TSIZE	Time step for automatic element deletion
ALP	Nonlinear shear stress parameter

<u>VARIABLE</u>	<u>DESCRIPTION</u>
SOFT	Softening reduction factor for strength in crush
FBRT	Softening of fiber tensile strength
SR	$s_r$ , reduction factor (default=0.447)
SF	$s_f$ , softening factor (default=0.0)
XC	Longitudinal compressive strength, a-axis (positive value).
XT	Longitudinal tensile strength, a-axis
YC	Transverse compressive strength, b-axis (positive value).
YT	Transverse tensile strength, b-axis
SC	Shear strength, ab plane: GT.0.0 faceted failure surface theory, LT.0.0 ellipsoidal failure surface theory.
SBA	In plane shear strength.
SCA	Transverse shear strength.
SCB	Transverse shear strength.
XXC	Longitudinal compressive strength a-axis (positive value).
YYC	Transverse compressive strength b-axis (positive value).
ZZC	Normal compressive strength c-axis (positive value).
XXT	Longitudinal tensile strength a-axis.
YYT	Transverse tensile strength b-axis.
ZZT	Normal tensile strength c-axis.

**\*MAT\_ELASTIC\_WITH\_VISCOSITY**

This is Material Type 60 which was developed to simulate forming of glass products (e.g., car windshields) at high temperatures. Deformation is by viscous flow but elastic deformations can also be large. The material model, in which the viscosity may vary with temperature, is suitable for treating a wide range of viscous flow problems and is implemented for brick and shell elements.

Card 1            1            2            3            4            5            6            7            8

Variable	MID	RO	V0	A	B	C	LCID	
Type	A8	F	F	F	F	F	F	

Card 2            1            2            3            4            5            6            7            8

Variable	PR1	PR2	PR3	PR4	PR5	PR6	PR7	PR8
Type	F	F	F	F	F	F	F	F

Card 3            1            2            3            4            5            6            7            8

Variable	T1	T2	T3	T4	T5	T6	T7	T8
Type	F	F	F	F	F	F	F	F

Card 4            1            2            3            4            5            6            7            8

Variable	V1	V2	V3	V4	V5	V6	V7	V8
Type	F	F	F	F	F	F	F	F

Card 5            1            2            3            4            5            6            7            8

Variable	E1	E2	E3	E4	E5	E6	E7	E8
Type	F	F	F	F	F	F	F	F

Card 6            1            2            3            4            5            6            7            8

Variable	ALPHA1	ALPHA2	ALPHA3	ALPHA4	ALPHA5	ALPHA6	ALPHA7	ALPHA8
Type	F	F	F	F	F	F	F	F

<u>VARIABLE</u>	<u>DESCRIPTION</u>
MID	Material identification. A unique number or label not exceeding 8 characters must be specified.
RO	Mass density
V0	Temperature independent viscosity coefficient, $V_0$ . If defined, the temperature dependent viscosity defined below is skipped, see type (i) and (ii) definitions for viscosity below.
A	Viscosity coefficient, see type (i) and (ii) definitions for viscosity below.
B	Viscosity coefficient, see type (i) and (ii) definitions for viscosity below.
C	Viscosity coefficient, see type (i) and (ii) definitions for viscosity below.
LCID	Load curve (see *DEFINE_CURVE) defining viscosity versus temperature, see type (iii). (Optional)
T1, T2,...TN	Temperatures, define up to 8 values
PR1, PR2,...PRN	Poisson's ratios for the temperatures $T_i$
V1, V2,...VN	Corresponding viscosity coefficients (define only one if not varying with temperature)
E1, E2,...EN	Corresponding Young's moduli coefficients (define only one if not varying with temperature)

VARIABLE	DESCRIPTION
ALPHA....	Corresponding thermal expansion coefficients

**Remarks:**

Volumetric behavior is treated as linear elastic. The deviatoric strain rate is considered to be the sum of elastic and viscous strain rates:

$$\dot{\epsilon}'_{\sim total} = \dot{\epsilon}'_{\sim elastic} + \dot{\epsilon}'_{\sim viscous} = \frac{\sigma'}{2G} + \frac{\sigma'}{2\nu}$$

where G is the elastic shear modulus, ν is the viscosity coefficient, and ~ indicates a tensor. The stress increment over one timestep dt is

$$d\sigma' = 2G\dot{\epsilon}'_{total}dt - \frac{G}{\nu}dt\sigma'$$

The stress before the update is used for σ'. For shell elements the through-thickness strain rate is calculated as follows.

$$d\sigma_{33} = 0 = K\left(\dot{\epsilon}_{11} + \dot{\epsilon}_{22} + \dot{\epsilon}_{33}\right)dt + 2G\dot{\epsilon}'_{33}dt - \frac{G}{\nu}dt\sigma'_{33}$$

where the subscript ij = 33 denotes the through-thickness direction and K is the elastic bulk modulus. This leads to:

$$\dot{\epsilon}_{33} = -a\left(\dot{\epsilon}_{11} + \dot{\epsilon}_{22}\right) + bp$$

$$a = \frac{\left(K - \frac{2}{3}G\right)}{\left(K + \frac{4}{3}G\right)}$$

$$b = \frac{Gdt}{\nu\left(K + \frac{4}{3}G\right)}$$

in which p is the pressure defined as the negative of the hydrostatic stress.

The variation of viscosity with temperature can be defined in any one of the 3 ways.

- (i) Constant, V = V<sub>0</sub> Do not define constants, A, B, and C or the piecewise curve.(leave card 4 blank)
- (ii) V = V<sub>0</sub> × 10\*\* (A/(T-B) + C)
- (iii) Piecewise curve: define the variation of viscosity with temperature.

**Note:** Viscosity is inactive during dynamic relaxation.

\*MAT\_ELASTIC\_WITH\_VISCOSITY\_CURVE

This is Material Type 60 which was developed to simulate forming of glass products (e.g., car windshields) at high temperatures. Deformation is by viscous flow but elastic deformations can also be large. The material model, in which the viscosity may vary with temperature, is suitable for treating a wide range of viscous flow problems and is implemented for brick and shell elements. Load curves are used to represent the temperature dependence of Poisson's ratio, Young's modulus, the coefficient of expansion, and the viscosity.

Card 1            1            2            3            4            5            6            7            8

Variable	MID	RO	V0	A	B	C	LCID	
Type	A8	F	F	F	F	F	F	

Card 2            1            2            3            4            5            6            7            8

Variable	PR_LC	YM_LC	A_LC	V_LC	V_LOG			
Type	F	F	F	F	F			

<u>VARIABLE</u>	<u>DESCRIPTION</u>
MID	Material identification. A unique number or label not exceeding 8 characters must be specified.
RO	Mass density
V0	Temperature independent viscosity coefficient, $V_0$ . If defined, the temperature dependent viscosity defined below is skipped, see type (i) and (ii) definitions for viscosity below.
A	Viscosity coefficient, see type (i) and (ii) definitions for viscosity below.
B	Viscosity coefficient, see type (i) and (ii) definitions for viscosity below.
C	Viscosity coefficient, see type (i) and (ii) definitions for viscosity below.
LCID	Load curve (see *DEFINE_CURVE) defining factor on viscosity versus temperature, see type (iii). (Optional).

<u>VARIABLE</u>	<u>DESCRIPTION</u>
PR_LC	Load curve (see *DEFINE_CURVE) defining Poisson’s ratio as a function of temperature.
YM_LC	Load curve (see *DEFINE_CURVE) defining Young’s modulus as a function of temperature.
A_LC	Load curve (see *DEFINE_CURVE) defining the coefficient of thermal expansion as a function of temperature.
V_LC	Load curve (see *DEFINE_CURVE) defining the viscosity as a function of temperature.
V_LOG	Flag for the form of V_LC. If V_LOG=1.0, the value specified in V_LC is the natural logarithm of the viscosity, ln(V). The value interpolated from the curve is then exponentiated to obtain the viscosity. If V_LOG=0.0, the value is the viscosity. The logarithmic form is useful if the value of the viscosity changes by orders of magnitude over the temperature range of the data.

**Remarks:**

Volumetric behavior is treated as linear elastic. The deviatoric strain rate is considered to be the sum of elastic and viscous strain rates:

$$\dot{\epsilon}'_{\sim total} = \dot{\epsilon}'_{\sim elastic} + \dot{\epsilon}'_{\sim viscous} = \frac{\dot{\sigma}'}{2G} + \frac{\dot{\sigma}'}{2\nu}$$

where G is the elastic shear modulus, ν is the viscosity coefficient, and ~ indicates a tensor. The stress increment over one timestep dt is

$$d\sigma' = 2G\dot{\epsilon}'_{total}dt - \frac{G}{\nu}dt\sigma'$$

The stress before the update is used for σ'. For shell elements the through-thickness strain rate is calculated as follows.

$$d\sigma_{33} = 0 = K \left( \dot{\epsilon}_{11} + \dot{\epsilon}_{22} + \dot{\epsilon}_{33} \right) dt + 2G \dot{\epsilon}'_{33} dt - \frac{G}{\nu} dt\sigma'_{33}$$

where the subscript ij = 33 denotes the through-thickness direction and K is the elastic bulk modulus. This leads to:

$$\dot{\epsilon}_{33} = -a \left( \dot{\epsilon}_{11} + \dot{\epsilon}_{22} \right) + bp$$



$$a = \frac{\left(K - \frac{2}{3}G\right)}{\left(K + \frac{4}{3}G\right)}$$

$$b = \frac{Gdt}{\nu\left(K + \frac{4}{3}G\right)}$$

in which  $p$  is the pressure defined as the negative of the hydrostatic stress.

The variation of viscosity with temperature can be defined in any one of the 3 ways.

- (i) Constant,  $V = V_0$  Do not define constants, A, B, and C or the piecewise curve.(leave card 4 blank)
- (ii)  $V = V_0 \times 10^{**} (A/(T-B) + C)$
- (iii) Piecewise curve: define the variation of viscosity with temperature.

**Note:** Viscosity is inactive during dynamic relaxation.

**\*MAT\_KELVIN-MAXWELL\_VISCOELASTIC**

This is Material Type 61. This material is a classical Kelvin-Maxwell model for modeling viscoelastic bodies, e.g., foams. This model is valid for solid elements only. See also notes below.

Card 1            1            2            3            4            5            6            7            8

Variable	MID	RO	BULK	G0	GI	DC	FO	SO
Type	A8	F	F	F	F	F	F	F
Default	none	none	none	none	none	0.0	0.0	0.0

<u>VARIABLE</u>	<u>DESCRIPTION</u>
MID	Material identification. A unique number or label not exceeding 8 characters must be specified.
RO	Mass density
BULK	Bulk modulus (elastic)
G0	Short-time shear modulus, $G_0$
GI	Long-time (infinite) shear modulus, $G_\infty$
DC	Maxwell decay constant, $\beta$ [FO=0.0] or Kelvin relaxation constant, $\tau$ [FO=1.0]
FO	Formulation option: EQ.0.0: Maxwell, EQ.1.0: Kelvin.
SO	Strain (logarithmic) output option to control what is written as component 7 to the d3plot database. (LS-Prepost always blindly labels this component as effective plastic strain.) The maximum values are updated for each element each time step: EQ.0.0: maximum principal strain that occurs during the calculation, EQ.1.0: maximum magnitude of the principal strain values that occurs during the calculation, EQ.2.0: maximum effective strain that occurs during the calculation.

**Remarks:**

The shear relaxation behavior is described for the Maxwell model by:

$$G(t) = G + (G_0 - G_\infty)e^{-\beta t}$$

A Jaumann rate formulation is used

$$\overset{\nabla}{\sigma}'_{ij} = 2 \int_0^t G(t - \tau) D'_{ij}(\tau) dt$$

where the prime denotes the deviatoric part of the stress rate,  $\overset{\nabla}{\sigma}'_{ij}$ , and the strain rate  $D_{ij}$ . For the Kelvin model the stress evolution equation is defined as:

$$\dot{s}_{ij} + \frac{1}{\tau} s_{ij} = (1 + \delta_{ij}) G_0 \dot{\epsilon}_{ij} + (1 + \delta_{ij}) \frac{G_\infty}{\tau} \dot{\epsilon}_{ij}$$

The strain data as written to the LS-DYNA database may be used to predict damage, see [Bandak 1991].

**\*MAT\_VISCOUS\_FOAM**

This is Material Type 62. It was written to represent the Confor Foam on the ribs of EuroSID side impact dummy. It is only valid for solid elements, mainly under compressive loading.

Card 1            1            2            3            4            5            6            7            8

Variable	MID	RO	E1	N1	V2	E2	N2	PR
Type	A8	F	F	F	F	F	F	F

<u>VARIABLE</u>	<u>DESCRIPTION</u>
MID	Material identification. A unique number or label not exceeding 8 characters must be specified.
RO	Mass density
E1	Initial Young's modulus ( $E_1$ )
N1	Exponent in power law for Young's modulus ( $n_1$ )
V2	Viscous coefficient ( $V_2$ )
E2	Elastic modulus for viscosity ( $E_2$ ), see notes below.
N2	Exponent in power law for viscosity ( $n_2$ )
PR	Poisson's ratio, $\nu$

**Remarks:**

The model consists of a nonlinear elastic stiffness in parallel with a viscous damper. The elastic stiffness is intended to limit total crush while the viscosity absorbs energy. The stiffness  $E_2$  exists to prevent timestep problems. It is used for time step calculations as long as  $E_1^t$  is smaller than  $E_2$ . It has to be carefully chosen to take into account the stiffening effects of the viscosity. Both  $E_1$  and  $V_2$  are nonlinear with crush as follows:

$$E_1^t = E_1 (V^{-n_1})$$

$$V_2^t = V_2 (abs(1 - V))^{n_2}$$

where viscosity generates a shear stress given by

$$\tau = V_2 \dot{\gamma}$$

$\dot{\gamma}$  is the engineering shear strain rate, and V is the relative volume defined by the ratio of the current to initial volume. Typical values are (units of N, mm, s):

$$E_1=0.0036$$

$$n_1=4.0$$

$$V_2=0.0015$$

$$E_2=100.0$$

$$n_2=0.2$$

$$v=0.05$$

**\*MAT\_CRUSHABLE\_FOAM**

This is Material Type 63 which is dedicated to modeling crushable foam with optional damping and tension cutoff. Unloading is fully elastic. Tension is treated as elastic-perfectly-plastic at the tension cut-off value. A modified version of this model, \*MAT\_MODIFIED\_CRUSHABLE\_FOAM includes strain rate effects.

Card 1            1            2            3            4            5            6            7            8

Variable	MID	RO	E	PR	LCID	TSC	DAMP	
Type	A8	F	F	F	F	F	F	
Default	none	none	none	none	none	0.0	0.10	

<u>VARIABLE</u>	<u>DESCRIPTION</u>
MID	Material identification. A unique number or label not exceeding 8 characters must be specified.
RO	Mass density
E	Young's modulus
PR	Poisson's ratio
LCID	Load curve ID defining yield stress versus volumetric strain, $\gamma$ , see Figure 63.1.
TSC	Tensile stress cutoff. A nonzero, positive value is strongly recommended for realistic behavior.
DAMP	Rate sensitivity via damping coefficient ( $.05 < \text{recommended value} < .50$ ).

**Remarks:**

The volumetric strain is defined in terms of the relative volume, V, as:

$$\gamma = 1.-V$$

The relative volume is defined as the ratio of the current to the initial volume. In place of the effective plastic strain in the D3PLOT database, the integrated volumetric strain is output.

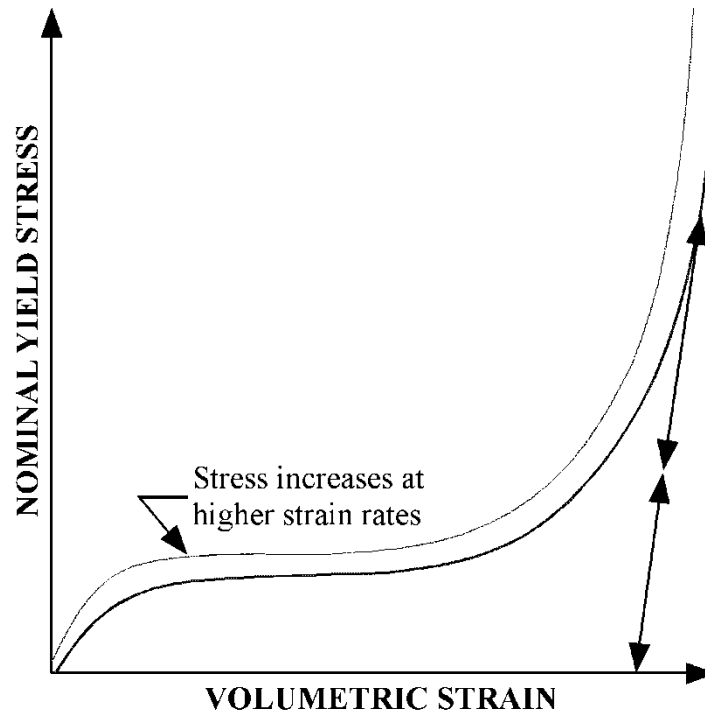

**Figure 63.1.** Behavior of strain rate sensitive crushable foam. Unloading is elastic to the tension cutoff. Subsequent reloading follows the unloading curve.

**\*MAT\_RATE\_SENSITIVE\_POWERLAW\_PLASTICITY**

This is Material Type 64 which will model strain rate sensitive elasto-plastic material with a power law hardening. Optionally, the coefficients can be defined as functions of the effective plastic strain.

Card 1            1            2            3            4            5            6            7            8

Variable	MID	RO	E	PR	K	M	N	E0
Type	A8	F	F	F	F	F	F	F
Default	none	none	none	none	none	0.0001	none	0.0002

Card 2            1            2            3            4            5            6            7            8

Variable	VP	EPS0						
Type	F	F						
Default	0.0	1.0						

<u>VARIABLE</u>	<u>DESCRIPTION</u>
MID	Material identification. A unique number or label not exceeding 8 characters must be specified.
RO	Mass density
E	Young's modulus of elasticity
PR	Poisson's ratio
K	Material constant, k. If k<0 the absolute value of k is taken as the load curve number that defines k as a function of effective plastic strain.
M	Strain hardening coefficient, m. If m<0 the absolute value of m is taken as the load curve number that defines m as a function of effective plastic strain.



<u>VARIABLE</u>	<u>DESCRIPTION</u>
N	Strain rate sensitivity coefficient, n. If n<0 the absolute value of n is taken as the load curve number that defines n as a function of effective plastic strain.
E0	Initial strain rate (default = 0.0002)
VP	Formulation for rate effects: EQ.0.0: Scale yield stress (default) EQ.1.0: Viscoplastic formulation
EPS0	Quasi-static threshold strain rate. See description under *MAT_015.

**Remarks:**

This material model follows a constitutive relationship of the form:

$$\sigma = k \varepsilon^m \dot{\varepsilon}^n$$

where  $\sigma$  is the yield stress,  $\varepsilon$  is the effective plastic strain,  $\dot{\varepsilon}$  is the normalized effective plastic strain rate, and the constants  $k$ ,  $m$ , and  $n$  can be expressed as functions of effective plastic strain or can be constant with respect to the plastic strain. The case of no strain hardening can be obtained by setting the exponent of the plastic strain equal to a very small positive value, i.e. 0.0001.

This model can be combined with the superplastic forming input to control the magnitude of the pressure in the pressure boundary conditions in order to limit the effective plastic strain rate so that it does not exceed a maximum value at any integration point within the model.

A fully viscoplastic formulation is optional. An additional cost is incurred but the improvement in results can be dramatic.

**\*MAT\_MODIFIED\_ZERILLI\_ARMSTRONG**

This is Material Type 65 which is a rate and temperature sensitive plasticity model which is sometimes preferred in ordnance design calculations.

Card 1            1            2            3            4            5            6            7            8

Variable	MID	RO	G	E0	N	TROOM	PC	SPALL
Type	A8	F	F	F	F	F	F	F

Card 2            1            2            3            4            5            6            7            8

Variable	C1	C2	C3	C4	C5	C6	EFAIL	VP
Type	F	F	F	F	F	F	F	F

Card 3            1            2            3            4            5            6            7            8

Variable	B1	B2	B3	G1	G2	G3	G4	BULK
Type	F	F	F	F	F	F	F	

<u>VARIABLE</u>	<u>DESCRIPTION</u>
MID	Material identification. A unique number or label not exceeding 8 characters must be specified.
RO	Mass density
G	Shear modulus
E0	$\dot{\epsilon}_0$ , factor to normalize strain rate
N	n, exponent for bcc metal
TROOM	$T_r$ , room temperature
PC	$p_c$ , Pressure cutoff

<u>VARIABLE</u>	<u>DESCRIPTION</u>
SPALL	Spall Type: EQ.1.0: minimum pressure limit, EQ.2.0: maximum principal stress, EQ.3.0: minimum pressure cutoff.
C1	C1, coefficients for flow stress, see notes below.
C2	C2, coefficients for flow stress, see notes below.
C3	C3, coefficients for flow stress, see notes below.
C4	C4, coefficients for flow stress, see notes below.
C5	C5, coefficients for flow stress, see notes below.
C6	C6, coefficients for flow stress, see notes below.
EFAIL	Failure strain for erosion
VP	Formulation for rate effects: EQ.0.0: Scale yield stress (default) EQ.1.0: Viscoplastic formulation
B1	B1, coefficients for polynomial to represent temperature dependency of flow stress yield.
B2	B2
B3	B3
G1	G1, coefficients for defining heat capacity and temperature dependency of heat capacity.
G2	G2
G3	G3
G4	G4
BULK	Bulk modulus defined for shell elements only. Do not input for solid elements.

**Remarks:**

The Armstrong-Zerilli Material Model expresses the flow stress as follows.

For fcc metals ( $n=0$ ),

$$\sigma = C_1 + \left\{ C_2 (\varepsilon^p)^{1/2} \left[ e^{(-C_3 + C_4 \ln(\dot{\varepsilon}^*))T} \right] + C_5 \right\} \left( \frac{\mu(T)}{\mu(293)} \right)$$

$\varepsilon^p$  = effective plastic strain

$\dot{\varepsilon}^* = \frac{\dot{\varepsilon}}{\dot{\varepsilon}_0}$  effective plastic strain rate where  $\dot{\varepsilon}_0 = 1, 1e-3, 1e-6$  for time units of seconds, milliseconds, and microseconds, respectively.

For bcc metals ( $n>0$ ),

$$\sigma = C_1 + C_2 e^{(-C_3 + C_4 \ln(\dot{\varepsilon}^*))T} + \left[ C_5 (\varepsilon^p)^n + C_6 \right] \left( \frac{\mu(T)}{\mu(293)} \right)$$

where

$$\left( \frac{\mu(T)}{\mu(293)} \right) = B_1 + B_2 T + B_3 T^2.$$

The relationship between heat capacity (specific heat) and temperature may be characterized by a cubic polynomial equation as follows:

$$C_p = G_1 + G_2 T + G_3 T^2 + G_4 T^3$$

A fully viscoplastic formulation is optional. An additional cost is incurred but the improvement in results can be dramatic.

\*MAT\_LINEAR\_ELASTIC\_DISCRETE\_BEAM

This is Material Type 66. This material model is defined for simulating the effects of a linear elastic beam by using six springs each acting about one of the six local degrees-of-freedom. The two nodes defining a beam may be coincident to give a zero length beam, or offset to give a finite length beam. For finite length discrete beams the absolute value of the variable SCOR in the SECTION\_BEAM input should be set to a value of 2.0, which causes the local r-axis to be aligned along the two nodes of the beam to give physically correct behavior. The distance between the nodes of a beam should not affect the behavior of this model. A triad is used to orient the beam for the directional springs. Translational/rotational stiffness and viscous damping effects are considered for a local cartesian system, see notes below. Applications for this element include the modeling of joint stiffnesses.

Card 1            1            2            3            4            5            6            7            8

Variable	MID	RO	TKR	TKS	TKT	RKR	RKS	RKT
Type	A8	F	F	F	F	F	F	F

Card 2            1            2            3            4            5            6            7            8

Variable	TDR	TDS	TDT	RDR	RDS	RDT		
Type	F	F	F	F	F	F		

Card 3            1            2            3            4            5            6            7            8

Variable	FOR	FOS	FOT	MOR	MOS	MOT		
Type	F	F	F	F	F	F		

<u>VARIABLE</u>	<u>DESCRIPTION</u>
MID	Material identification. A unique number or label not exceeding 8 characters must be specified.
RO	Mass density, see also “volume” in the *SECTION_BEAM definition.
TKR	Translational stiffness along local r-axis, see notes below.

<u>VARIABLE</u>	<u>DESCRIPTION</u>
TKS	Translational stiffness along local s-axis.
TKT	Translational stiffness along local t-axis.
RKR	Rotational stiffness about the local r-axis.
RKS	Rotational stiffness about the local s-axis.
RKT	Rotational stiffness about the local t-axis.
TDR	Translational viscous damper along local r-axis. (Optional)
TDS	Translational viscous damper along local s-axis. (Optional)
TDT	Translational viscous damper along local t-axis. (Optional)
RDR	Rotational viscous damper about the local r-axis. (Optional)
RDS	Rotational viscous damper about the local s-axis. (Optional)
RDT	Rotational viscous damper about the local t-axis. (Optional)
FOR	Preload force in r-direction. (Optional)
FOS	Preload force in s-direction. (Optional)
FOT	Preload force in t-direction. (Optional)
MOR	Preload moment about r-axis. (Optional)
MOS	Preload moment about s-axis. (Optional)
MOT	Preload moment about t-axis. (Optional)

**Remarks:**

The formulation of the discrete beam (type 6) assumes that the beam is of zero length and requires no orientation node. A small distance between the nodes joined by the beam is permitted. The local coordinate system which determines (r,s,t) is given by the coordinate ID, see \*DEFINE\_COORDINATE\_OPTION, in the cross sectional input, see \*SECTION\_BEAM, where the global system is the default. The local coordinate system axes can rotate with either node of the beam or an average rotation of both nodes (see SCOOR variable in \*SECTION\_BEAM).

For null stiffness coefficients, no forces corresponding to these null values will develop. The viscous damping coefficients are optional.

\*MAT\_NONLINEAR\_ELASTIC\_DISCRETE\_BEAM

This is Material Type 67. This material model is defined for simulating the effects of nonlinear elastic and nonlinear viscous beams by using six springs each acting about one of the six local degrees-of-freedom. The two nodes defining a beam may be coincident to give a zero length beam, or offset to give a finite length beam. For finite length discrete beams the absolute value of the variable SCOOR in the SECTION\_BEAM input should be set to a value of 2.0, which causes the local r-axis to be aligned along the two nodes of the beam to give physically correct behavior. The distance between the nodes of a beam should not affect the behavior of this material model. A triad is used to orient the beam for the directional springs. Arbitrary curves to model transitional/ rotational stiffness and damping effects are allowed. See notes below.

Card 1            1            2            3            4            5            6            7            8

Variable	MID	RO	LCIDTR	LCIDTS	LCIDTT	LCIDRR	LCIDRS	LCIDRT
Type	A8	F	F	F	F	F	F	F

Card 2            1            2            3            4            5            6            7            8

Variable	LCIDTDR	LCIDTDS	LCIDTDT	LCIDRDR	LCIDRDS	LCIDRDT		
Type	F	F	F	F	F	F		

Card 3            1            2            3            4            5            6            7            8

Variable	FOR	FOS	FOT	MOR	MOS	MOT		
Type	F	F	F	F	F	F		

**Cards 4 and 5 must be defined to consider failure; otherwise, they are optional.**

Card 4            1            2            3            4            5            6            7            8

Variable	FFAILR	FFAILS	FFAILT	MFAILR	MFAILS	MFAILT		
Type	F	F	F	F	F	F		
Default	0.0	0.0	0.0	0.0	0.0	0.0		

Card 5            1            2            3            4            5            6            7            8

Variable	UFAILR	UFAILS	UFAILT	TFAILR	TFAILS	TFAILT		
Type	F	F	F	F	F	F		
Default	0.0	0.0	0.0	0.0	0.0	0.0		

<u>VARIABLE</u>	<u>DESCRIPTION</u>
MID	Material identification. A unique number or label not exceeding 8 characters must be specified.
RO	Mass density, see also volume in *SECTION_BEAM definition.
LCIDTR	Load curve ID defining translational force resultant along local r-axis versus relative translational displacement, see Remarks and Figure 67.1.
LCIDTS	Load curve ID defining translational force resultant along local s-axis versus relative translational displacement.
LCIDTT	Load curve ID defining translational force resultant along local t-axis versus relative translational displacement.
LCIDRR	Load curve ID defining rotational moment resultant about local r-axis versus relative rotational displacement.
LCIDRS	Load curve ID defining rotational moment resultant about local s-axis versus relative rotational displacement.
LCIDRT	Load curve ID defining rotational moment resultant about local t-axis versus relative rotational displacement.



VARIABLE	DESCRIPTION
LCIDTDR	Load curve ID defining translational damping force resultant along local r-axis versus relative translational velocity.
LCIDTDS	Load curve ID defining translational damping force resultant along local s-axis versus relative translational velocity.
LCIDTDT	Load curve ID defining translational damping force resultant along local t-axis versus relative translational velocity.
LCIDRDR	Load curve ID defining rotational damping moment resultant about local r-axis versus relative rotational velocity.
LCIDRDS	Load curve ID defining rotational damping moment resultant about local s-axis versus relative rotational velocity.
LCIDRDT	Load curve ID defining rotational damping moment resultant about local t-axis versus relative rotational velocity.
FOR	Preload force in r-direction. (Optional)
FOS	Preload force in s-direction. (Optional)
FOT	Preload force in t-direction. (Optional)
MOR	Preload moment about r-axis. (Optional)
MOS	Preload moment about s-axis. (Optional)
MOT	Preload moment about t-axis. (Optional)
FFAILR	Optional failure parameter. If zero, the corresponding force, $F_r$ , is not considered in the failure calculation.
FFAILS	Optional failure parameter. If zero, the corresponding force, $F_s$ , is not considered in the failure calculation.
FFAILT	Optional failure parameter. If zero, the corresponding force, $F_t$ , is not considered in the failure calculation.
MFAILR	Optional failure parameter. If zero, the corresponding moment, $M_r$ , is not considered in the failure calculation.
MFAILS	Optional failure parameter. If zero, the corresponding moment, $M_s$ , is not considered in the failure calculation.
MFAILT	Optional failure parameter. If zero, the corresponding moment, $M_t$ , is not considered in the failure calculation.

<u>VARIABLE</u>	<u>DESCRIPTION</u>
UFAILR	Optional failure parameter. If zero, the corresponding displacement, $u_r$ , is not considered in the failure calculation.
UFAILS	Optional failure parameter. If zero, the corresponding displacement, $u_s$ , is not considered in the failure calculation.
UFAILT	Optional failure parameter. If zero, the corresponding displacement, $u_t$ , is not considered in the failure calculation.
TFAILR	Optional failure parameter. If zero, the corresponding rotation, $\theta_r$ , is not considered in the failure calculation.
TFAILS	Optional failure parameter. If zero, the corresponding rotation, $\theta_s$ , is not considered in the failure calculation.
TFAILT	Optional failure parameter. If zero, the corresponding rotation, $\theta_t$ , is not considered in the failure calculation.

**Remarks:**

For null load curve ID's, no forces are computed.

The formulation of the discrete beam (type 6) assumes that the beam is of zero length and requires no orientation node. A small distance between the nodes joined by the beam is permitted. The local coordinate system which determines (r,s,t) is given by the coordinate ID, see *\*DEFINE\_COORDINATE\_OPTION*, in the cross sectional input, see *\*SECTION\_BEAM*, where the global system is the default. The local coordinate system axes can rotate with either node of the beam or an average rotation of both nodes (see *SCOOR* variable in *\*SECTION\_BEAM*).

If different behavior in tension and compression is desired in the calculation of the force resultants, the load curve(s) must be defined in the negative quadrant starting with the most negative displacement then increasing monotonically to the most positive. If the load curve behaves similarly in tension and compression, define only the positive quadrant. Whenever displacement values fall outside of the defined range, the resultant forces will be extrapolated. Figure 67.1 depicts a typical load curve for a force resultant. Load curves used for determining the damping forces and moment resultants always act identically in tension and compression, since only the positive quadrant values are considered, i.e., start the load curve at the origin [0,0].

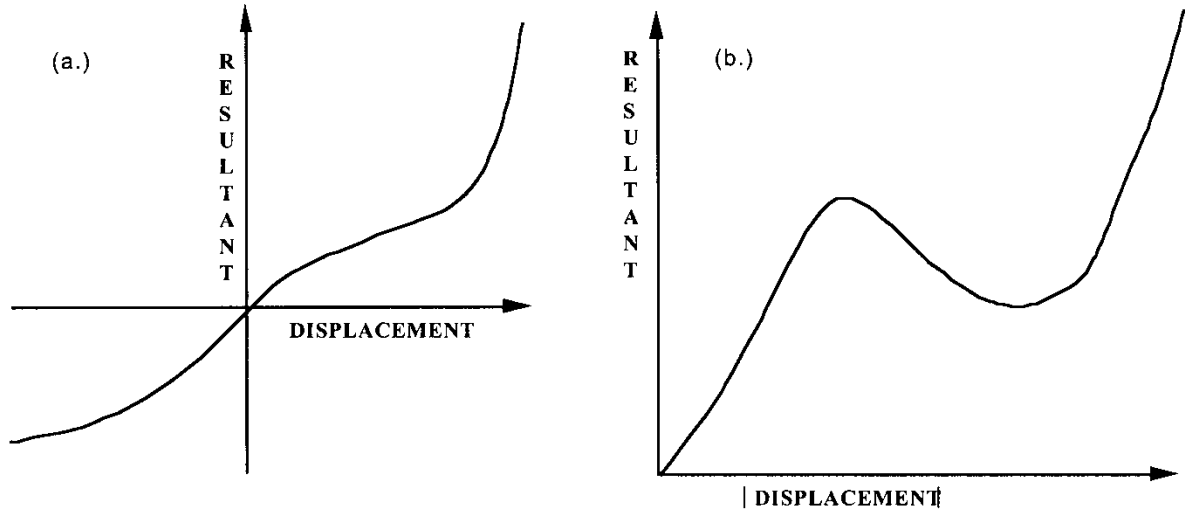

**Figure 67.1.** The resultant forces and moments are determined by a table lookup. If the origin of the load curve is at [0,0] as in (b.) and tension and compression responses are symmetric.

Catastrophic failure based on force resultants occurs if the following inequality is satisfied.

$$\left(\frac{F_r}{F_r^{fail}}\right)^2 + \left(\frac{F_s}{F_s^{fail}}\right)^2 + \left(\frac{F_t}{F_t^{fail}}\right)^2 + \left(\frac{M_r}{M_r^{fail}}\right)^2 + \left(\frac{M_s}{M_s^{fail}}\right)^2 + \left(\frac{M_t}{M_t^{fail}}\right)^2 - 1. \geq 0.$$

After failure the discrete element is deleted. Likewise, catastrophic failure based on displacement resultants occurs if the following inequality is satisfied:

$$\left(\frac{u_r}{u_r^{fail}}\right)^2 + \left(\frac{u_s}{u_s^{fail}}\right)^2 + \left(\frac{u_t}{u_t^{fail}}\right)^2 + \left(\frac{\theta_r}{\theta_r^{fail}}\right)^2 + \left(\frac{\theta_s}{\theta_s^{fail}}\right)^2 + \left(\frac{\theta_t}{\theta_t^{fail}}\right)^2 - 1. \geq 0.$$

After failure the discrete element is deleted. If failure is included either one or both of the criteria may be used.

**\*MAT\_NONLINEAR\_PLASTIC\_DISCRETE\_BEAM**

This is Material Type 68. This material model is defined for simulating the effects of nonlinear elastoplastic, linear viscous behavior of beams by using six springs each acting about one of the six local degrees-of-freedom. The two nodes defining a beam may be coincident to give a zero length beam, or offset to give a finite length beam. For finite length discrete beams the absolute value of the variable SCOOR in the SECTION\_BEAM input should be set to a value of 2.0, which causes the local r-axis to be aligned along the two nodes of the beam to give physically correct behavior. The distance between the nodes of a beam should not affect the behavior of this material model. A triad is used to orient the beam for the directional springs. Translational/rotational stiffness and damping effects can be considered. The plastic behavior is modeled using force/moment curves versus displacements/ rotation. Optionally, failure can be specified based on a force/moment criterion and a displacement/ rotation criterion. See also notes below.

Card 1            1            2            3            4            5            6            7            8

Variable	MID	RO	TKR	TKS	TKT	RKR	RKS	RKT
Type	A8	F	F	F	F	F	F	F
Default	none	none	none	none	none	none	none	none

Card 2            1            2            3            4            5            6            7            8

Variable	TDR	TDS	TDT	RDR	RDS	RDT		
Type	F	F	F	F	F	F		
Default	none	none	none	none	none	none		

Card 3            1            2            3            4            5            6            7            8

Variable	LCPDR	LCPDS	LCPDT	LCPMR	LCPMS	LCPMT		
Type	F	F	F	F	F	F		
Default	0.0	0.0	0.0	0.0	0.0	0.0		

Card 4            1            2            3            4            5            6            7            8

Variable	FFAILR	FFAILS	FFAILT	MFAILR	MFAILS	MFAILT		
Type	F	F	F	F	F	F		
Default	0.0	0.0	0.0	0.0	0.0	0.0		

Card 5            1            2            3            4            5            6            7            8

Variable	UFAILR	UFAILS	UFAILT	TFAILR	TFAILS	TFAILT		
Type	F	F	F	F	F	F		
Default	0.0	0.0	0.0	0.0	0.0	0.0		

Card 6            1            2            3            4            5            6            7            8

Variable	FOR	FOS	FOT	MOR	MOS	MOT		
Type	F	F	F	F	F	F		

<u>VARIABLE</u>	<u>DESCRIPTION</u>
MID	Material identification. A unique number or label not exceeding 8 characters must be specified.
RO	Mass density, see also volume on *SECTION_BEAM definition.
TKR	Translational stiffness along local r-axis
TKS	Translational stiffness along local s-axis
TKT	Translational stiffness along local t-axis
RKR	Rotational stiffness about the local r-axis
RKS	Rotational stiffness about the local s-axis
RKT	Rotational stiffness about the local t-axis
TDR	Translational viscous damper along local r-axis
TDS	Translational viscous damper along local s-axis
TDT	Translational viscous damper along local t-axis
RDR	Rotational viscous damper about the local r-axis
RDS	Rotational viscous damper about the local s-axis
RDT	Rotational viscous damper about the local t-axis
LCPDR	Load curve ID-yield force versus plastic displacement r-axis. If the curve ID is zero, and if TKR is nonzero, then elastic behavior is obtained for this component.
LCPDS	Load curve ID-yield force versus plastic displacement s-axis. If the curve ID is zero, and if TKS is nonzero, then elastic behavior is obtained for this component.
LCPDT	Load curve ID-yield force versus plastic displacement t-axis. If the curve ID is zero, and if TKT is nonzero, then elastic behavior is obtained for this component.
LCPMR	Load curve ID-yield moment versus plastic rotation r-axis. If the curve ID is zero, and if RKR is nonzero, then elastic behavior is obtained for this component.
LCPMS	Load curve ID-yield moment versus plastic rotation s-axis. If the curve ID is zero, and if RKS is nonzero, then elastic behavior is obtained for this component.

VARIABLE	DESCRIPTION
LCPMT	Load curve ID-yield moment versus plastic rotation t-axis. If the curve ID is zero, and if RKT is nonzero, then elastic behavior is obtained for this component.
FFAILR	Optional failure parameter. If zero, the corresponding force, $F_r$ , is not considered in the failure calculation.
FFAILS	Optional failure parameter. If zero, the corresponding force, $F_s$ , is not considered in the failure calculation.
FFAILT	Optional failure parameter. If zero, the corresponding force, $F_t$ , is not considered in the failure calculation.
MFAILR	Optional failure parameter. If zero, the corresponding moment, $M_r$ , is not considered in the failure calculation.
MFAILS	Optional failure parameter. If zero, the corresponding moment, $M_s$ , is not considered in the failure calculation.
MFAILT	Optional failure parameter. If zero, the corresponding moment, $M_t$ , is not considered in the failure calculation.
UFAILR	Optional failure parameter. If zero, the corresponding displacement, $u_r$ , is not considered in the failure calculation.
UFAILS	Optional failure parameter. If zero, the corresponding displacement, $u_s$ , is not considered in the failure calculation.
UFAILT	Optional failure parameter. If zero, the corresponding displacement, $u_t$ , is not considered in the failure calculation.
TFAILR	Optional failure parameter. If zero, the corresponding rotation, $\theta_r$ , is not considered in the failure calculation.
TFAILS	Optional failure parameter. If zero, the corresponding rotation, $\theta_s$ , is not considered in the failure calculation.
TFAILT	Optional failure parameter. If zero, the corresponding rotation, $\theta_t$ , is not considered in the failure calculation.
FOR	Preload force in r-direction. (Optional)
FOS	Preload force in s-direction. (Optional)
FOT	Preload force in t-direction. (Optional)

<u>VARIABLE</u>	<u>DESCRIPTION</u>
MOR	Preload moment about r-axis. (Optional)
MOS	Preload moment about s-axis. (Optional)
MOT	Preload moment about t-axis. (Optional)

**Remarks:**

For the translational and rotational degrees of freedom where elastic behavior is desired, set the load curve ID to zero.

The formulation of the discrete beam (type 6) assumes that the beam is of zero length and requires no orientation node. A small distance between the nodes joined by the beam is permitted. The local coordinate system which determines (r,s,t) is given by the coordinate ID (see \*DEFINE\_COORDINATE\_OPTION) in the cross sectional input, see \*SECTION\_BEAM, where the global system is the default. The local coordinate system axes can rotate with either node of the beam or an average rotation of both nodes (see SCOR variable in \*SECTION\_BEAM).

Catastrophic failure based on force resultants occurs if the following inequality is satisfied.

$$\left(\frac{F_r}{F_r^{fail}}\right)^2 + \left(\frac{F_s}{F_s^{fail}}\right)^2 + \left(\frac{F_t}{F_t^{fail}}\right)^2 + \left(\frac{M_r}{M_r^{fail}}\right)^2 + \left(\frac{M_s}{M_s^{fail}}\right)^2 + \left(\frac{M_t}{M_t^{fail}}\right)^2 - 1. \geq 0.$$

After failure the discrete element is deleted. Likewise, catastrophic failure based on displacement resultants occurs if the following inequality is satisfied:

$$\left(\frac{u_r}{u_r^{fail}}\right)^2 + \left(\frac{u_s}{u_s^{fail}}\right)^2 + \left(\frac{u_t}{u_t^{fail}}\right)^2 + \left(\frac{\theta_r}{\theta_r^{fail}}\right)^2 + \left(\frac{\theta_s}{\theta_s^{fail}}\right)^2 + \left(\frac{\theta_t}{\theta_t^{fail}}\right)^2 - 1. \geq 0.$$

After failure the discrete element is deleted. If failure is included either one or both of the criteria may be used.



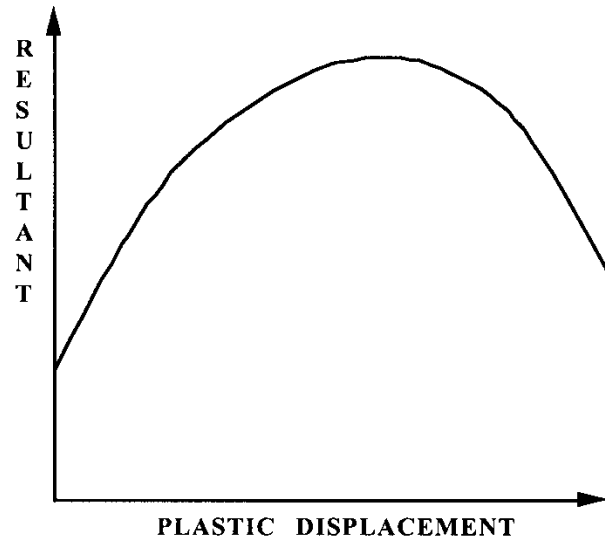

**Figure 68.1.** The resultant forces and moments are limited by the yield definition. The initial yield point corresponds to a plastic displacement of zero.

**\*MAT\_SID\_DAMPER\_DISCRETE\_BEAM**

This is Material Type 69. The side impact dummy uses a damper that is not adequately treated by the nonlinear force versus relative velocity curves since the force characteristics are dependent on the displacement of the piston. See also notes below.

Card 1            1            2            3            4            5            6            7            8

Variable	MID	RO	ST	D	R	H	K	C
Type	A8	F	F	F	F	F	F	F

Card 2            1            2            3            4            5            6            7            8

Variable	C3	STF	RHOF	C1	C2	LCIDF	LCIDD	S0
Type	F	F	F	F	F	F	F	F

**Read in up to 15 orifice locations with orifice location per card. Input is terminated when a “\*” card is found. On the first card below the optional input parameters SF and DF may be specified.**

Cards 3...        1            2            3            4            5            6            7            8

Variable	ORFLOC	ORFRAD	SF	DC				
Type	F	F	F	F				

<u>VARIABLE</u>	<u>DESCRIPTION</u>
MID	Material identification. A unique number or label not exceeding 8 characters must be specified.
RO	Mass density, see also volume on *SECTION_BEAM definition.
ST	$S_t$ , piston stroke. $S_t$ must equal or exceed the length of the beam element, see Figure 69.1 below.
D	d, piston diameter

VARIABLE	DESCRIPTION
R	R, default orifice radius
H	h, orifice controller position
K	K, damping constant LT.0.0:  K  is the load curve number ID, see *DEFINE_CURVE, defining the damping coefficient as a function of the <u>absolute</u> value of the relative velocity.
C	C, discharge coefficient
C3	Coefficient for fluid inertia term
STF	k, stiffness coefficient if piston bottoms out
RHOF	$\rho_{fluid}$ , fluid density
C1	C <sub>1</sub> , coefficient for linear velocity term
C2	C <sub>2</sub> , coefficient for quadratic velocity term
LCIDF	Load curve number ID defining force versus piston displacement, s, i.e., term $f(s+s_0)$ . Compressive behavior is defined in the positive quadrant of the force displacement curve. Displacements falling outside of the defined force displacement curve are extrapolated. Care must be taken to ensure that extrapolated values are reasonable.
LCIDD	Load curve number ID defining damping coefficient versus piston displacement, s, i.e., $g(s+s_0)$ . Displacements falling outside the defined curve are extrapolated. Care must be taken to ensure that extrapolated values are reasonable.
S0	Initial displacement $s_0$ , typically set to zero. A positive displacement corresponds to compressive behavior.
ORFLOC	$d_j$ , orifice location of ith orifice relative to the fixed end.
ORFRAD	$r_j$ , orifice radius of ith orifice, if zero the default radius is used.
SF	Scale factor on calculated force. The default is set to 1.0
DC	c, linear viscous damping coefficient used after damper bottoms out either in tension or compression.

**Remarks:**

As the damper moves, the fluid flows through the open orifices to provide the necessary damping resistance. While moving as shown in Figure 69.1 the piston gradually blocks off and effectively closes the orifices. The number of orifices and the size of their opening control the damper resistance and performance. The damping force is computed from,

$$F = SF \left\{ KA_p V_p \left\{ \frac{C_1}{A_0^t} + C_2 |V_p| \rho_{fluid} \left[ \left( \frac{A_p}{CA_0^t} \right)^2 - 1 \right] \right\} - f(s + s_0) + V_p g(s + s_0) \right\}$$

where K is a user defined constant or a tabulated function of the absolute value of the relative velocity,  $V_p$  is the piston velocity, C is the discharge coefficient,  $A_p$  is the piston area,  $A_0^t$  is the total open areas of orifices at time t,  $\rho_{fluid}$  is the fluid density,  $C_1$  is the coefficient for the linear term, and  $C_2$  is the coefficient for the quadratic term.

In the implementation, the orifices are assumed to be circular with partial covering by the orifice controller. As the piston closes, the closure of the orifice is gradual. This gradual closure is properly taken into account to insure a smooth response. If the piston stroke is exceeded, the stiffness value, k, limits further movement, i.e., if the damper bottoms out in tension or compression the damper forces are calculated by replacing the damper by a bottoming out spring and damper,  $k$  and  $c$ , respectively. The piston stroke must exceed the initial length of the beam element. The time step calculation is based in part on the stiffness value of the bottoming out spring. A typical force versus displacement curve at constant relative velocity is shown in Figure 69.2.

The factor,  $SF$ , which scales the force defaults to 1.0 and is analogous to the adjusting ring on the damper.

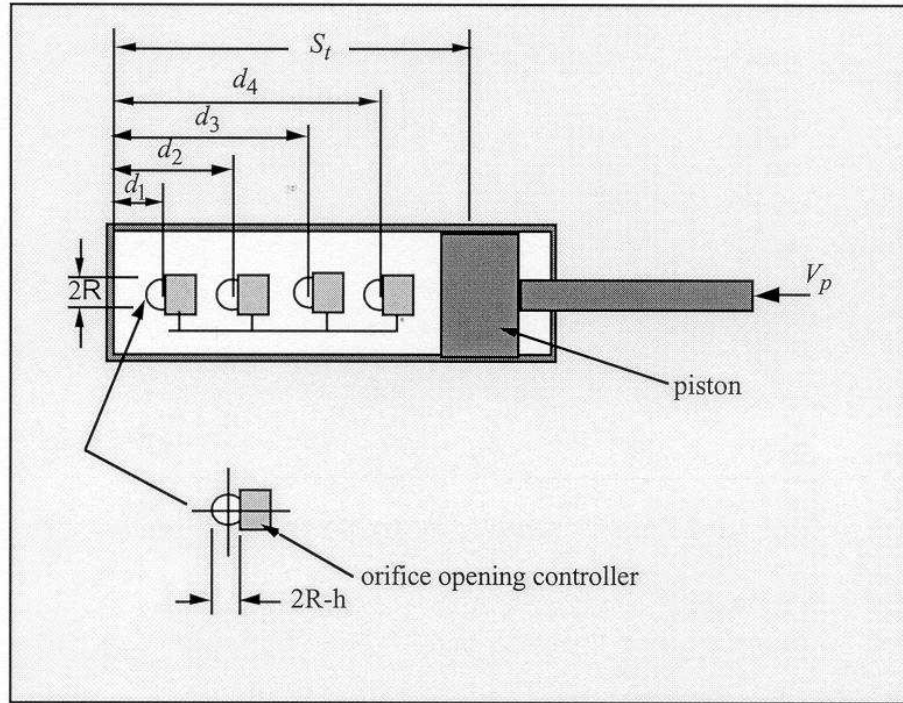

Figure 69.1. Mathematical model for the Side Impact Dummy damper.

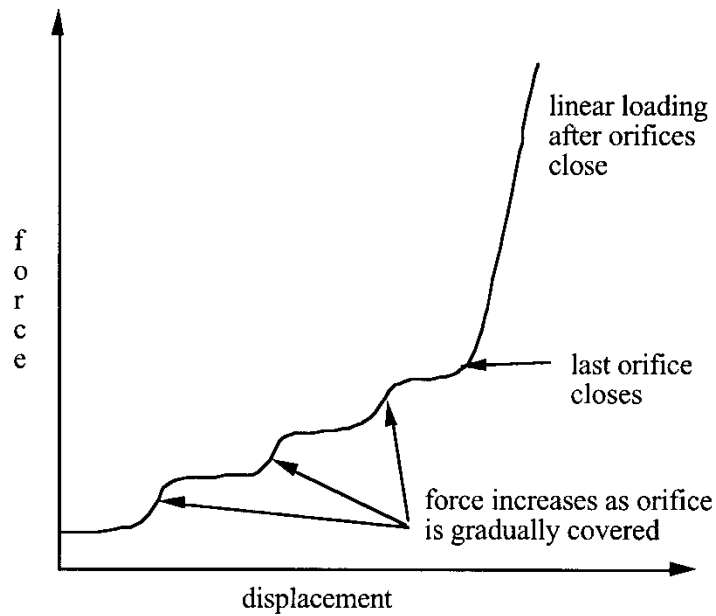

Figure 69.2. Force versus displacement as orifices are covered at a constant relative velocity. Only the linear velocity term is active.

# \*MAT\_070

# \*MAT\_HYDRAULIC\_GAS\_DAMPER\_DISCRETE\_BEAM

## \*MAT\_HYDRAULIC\_GAS\_DAMPER\_DISCRETE\_BEAM

This is Material Type 70. This special purpose element represents a combined hydraulic and gas-filled damper which has a variable orifice coefficient. A schematic of the damper is shown in Figure 70.1. Dampers of this type are sometimes used on buffers at the end of railroad tracks and as aircraft undercarriage shock absorbers. This material can be used only as a discrete beam element. See also notes below.

Card 1            1            2            3            4            5            6            7            8

Variable	MID	RO	CO	N	P0	PA	AP	KH
Type	A8	F	F	F	F	F	F	F

Card 2            1            2            3            4            5            6            7            8

Variable	LCID	FR	SCLF	CLEAR				
Type	F	F	F	F				

<u>VARIABLE</u>	<u>DESCRIPTION</u>
MID	Material identification. A unique number or label not exceeding 8 characters must be specified.
RO	Mass density, see also volume in *SECTION_BEAM definition.
CO	Length of gas column, $C_0$
N	Adiabatic constant
P0	Initial gas pressure, $P_0$
PA	Atmospheric pressure, $P_a$
AP	Piston cross sectional area, $A_p$
KH	Hydraulic constant, $K$
LCID	Load curve ID, see *DEFINE_CURVE, defining the orifice area, $a_0$ , versus element deflection.

VARIABLE	DESCRIPTION
FR	Return factor on orifice force. This acts as a factor on the hydraulic force only and is applied when unloading. It is intended to represent a valve that opens when the piston unloads to relieve hydraulic pressure. Set it to 1.0 for no such relief.
SCLF	Scale factor on force. (Default = 1.0)
CLEAR	Clearance (if nonzero, no tensile force develops for positive displacements and negative forces develop only after the clearance is closed).

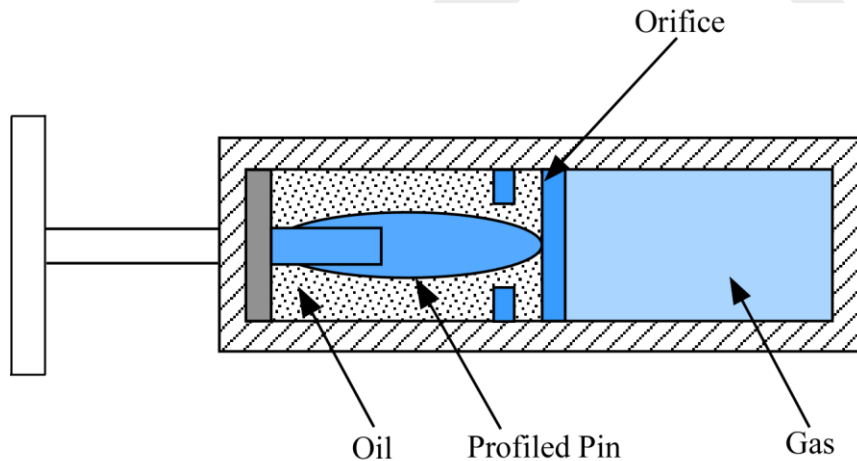

**Figure 70.1.** Schematic of Hydraulic/Gas damper.

### **Remarks:**

As the damper is compressed two actions contribute to the force which develops. First, the gas is adiabatically compressed into a smaller volume. Secondly, oil is forced through an orifice. A profiled pin may occupy some of the cross-sectional area of the orifice; thus, the orifice area available for the oil varies with the stroke. The force is assumed proportional to the square of the velocity and inversely proportional to the available area.

The equation for this element is:

$$F = SCLF \cdot \left\{ K_h \left( \frac{V}{a_0} \right)^2 + \left[ P_0 \left( \frac{C_0}{C_0 - S} \right)^n - P_a \right] \cdot A_p \right\}$$

where S is the element deflection and V is the relative velocity across the element.

**\*MAT\_CABLE\_DISCRETE\_BEAM**

This is Material Type 71. This model permits elastic cables to be realistically modeled; thus, no force will develop in compression.

Note: The following options will be available starting in release 3 of version 971: TMAXF0, TRAMP, IREAD, OUTPUT, TSTART.

Card 1            1            2            3            4            5            6            7            8

Variable	MID	RO	E	LCID	F0	TMAXF0	TRAMP	IREAD
Type	A8	F	F	F	F	F	F	I
Default	none	none	none	none	0	0	0	0

**Define Card 2 only if IREAD > 0**

Card 2            1            2            3            4            5            6            7            8

Variable	OUTPUT	TSTART						
Type	I	F						
Default	0	0						

<u>VARIABLE</u>	<u>DESCRIPTION</u>
MID	Material identification. A unique number or label not exceeding 8 characters must be specified.
RO	Mass density, see also volume in *SECTION_BEAM definition.
E	GT.0.0: Young's modulus LT.0.0: Stiffness
LCID	Load curve ID, see *DEFINE_CURVE, defining the stress versus engineering strain. (Optional).
F0	Initial tensile force. If F0 is defined, an offset is not needed for an initial tensile force.



<u>VARIABLE</u>	<u>DESCRIPTION</u>
TMAXF0	Time for which pre-tension force will be held
TRAMP	Ramp-up time for pre-tension force
IREAD	Set to 1 to read second line of input
OUTPUT	Flag =1 to output axial strain (see note)
TSTART	Time at which the ramp-up of pre-tension begins

**Remarks:**

The force,  $F$ , generated by the cable is nonzero if and only if the cable is tension. The force is given by:

$$F = \max(F_0 + K\Delta L, 0.)$$

where  $\Delta L$  is the change in length

$$\Delta L = \text{current length} - (\text{initial length} - \text{offset})$$

and the stiffness ( $E > 0.0$  only) is defined as:

$$K = \frac{E \cdot \text{area}}{(\text{initial length} - \text{offset})}$$

Note that a constant force element can be obtained by setting:

$$F_0 > 0 \text{ and } K = 0$$

although the application of such an element is unknown.

The area and offset are defined on either the cross section or element cards. For a slack cable the offset should be input as a negative length. For an initial tensile force the offset should be positive.

If a load curve is specified the Young's modulus will be ignored and the load curve will be used instead. The points on the load curve are defined as engineering stress versus engineering strain, i.e., the change in length over the initial length. The unloading behavior follows the loading.

By default, cable pretension is applied only at the start of the analysis. If the cable is attached to flexible structure, deformation of the structure will result in relaxation of the cables, which will therefore lose some or all of the intended preload.

This can be overcome by using TMAXF0. In this case, it is expected that the structure will deform under the loading from the cables and that this deformation will take time to occur during the analysis. The unstressed length of the cable will be continuously adjusted until time TMAXF0 such that the force is maintained at the user-defined pre-tension force – this is analogous to operation of the pre-tensioning screws in real cables. After time TMAXF0, the unstressed length is fixed and the force in the cable is determined in the normal way using the stiffness and change of length.

Sudden application of the cable forces at time zero may result in an excessively dynamic response during pre-tensioning. A ramp-up time TRAMP may optionally be defined. The cable force ramps up from zero at time TSTART to the full pre-tension F0 at time TSTART+TRAMP. TMAXF0, if set less than TSTART+TRAMP by the user, will be internally reset to TSTART+TRAMP.

If the model does not use dynamic relaxation, it is recommended that damping be applied during pre-tensioning so that the structure reaches a steady state by time TMAXF0.

If the model uses dynamic relaxation, TSTART, TRAMP, and TMAXF0 apply only during dynamic relaxation. The cable preload at the end of dynamic relaxation carries over to the start of the subsequent transient analysis.

The cable mass will be calculated from length x area x density if VOL is set to zero on \*SECTION\_BEAM. Otherwise, VOL x density will be used.

If OUTPUT is set in any cable material, extra variables will be written to the d3plot and d3thdt files for all beam elements. Post-processors should interpret the extra data as per Resultant beams. Only the first extra data item, axial strain, is computed for MAT\_CABLE elements.

If the stress-strain load curve option, LCID, is combined with preload, two types of behavior are available:

1. If the preload is applied using the TMAXF0/TRAMP method, the initial strain is calculated from the stress-strain curve to achieve the desired preload.
2. If TMAXF0/TRAMP are not used, the preload force is taken as additional to the force calculated from the stress/strain curve. Thus, the total stress in the cable will be higher than indicated by the stress/strain curve.

**\*MAT\_CONCRETE\_DAMAGE**

This is Material Type 72. This model has been used to analyze buried steel reinforced concrete structures subjected to impulsive loadings. A newer version of this model is available as \*MAT\_CONCRETE\_DAMAGE\_REL3

Card 1            1            2            3            4            5            6            7            8

Variable	MID	RO	PR					
Type	A8	F	F					
Default	none	none	none					

Card 2            1            2            3            4            5            6            7            8

Variable	SIGF	A0	A1	A2				
Type	F	F	F	F				
Default	0.0	0.0	0.0	0.0				

Card 3            1            2            3            4            5            6            7            8

Variable	A0Y	A1Y	A2Y	A1F	A2F	B1	B2	B3
Type	F	F	F	F	F	F	F	F
Default	0.0	0.0	0.0	0.0	0.0	0.0	0.0	0.0

Card 4            1            2            3            4            5            6            7            8

Variable	PER	ER	PRR	SIGY	ETAN	LCP	LCR	
Type	F	F	F	F	F	F	F	
Default	0.0	0.0	0.0	none	0.0	none	none	

Card 5            1            2            3            4            5            6            7            8

Variable	$\lambda$	$\lambda_2$	$\lambda_3$	$\lambda_4$	$\lambda_5$	$\lambda_6$	$\lambda_7$	$\lambda_8$
Type	F	F	F	F	F	F	F	F
Default	none	none	none	none	none	none	none	none

Card 6            1            2            3            4            5            6            7            8

Variable	$\lambda_9$	$\lambda_{10}$	$\lambda_{11}$	$\lambda_{12}$	$\lambda_{13}$			
Type	F	F	F	F	F			
Default	none	none	none	none	none			

Card 7            1            2            3            4            5            6            7            8

Variable	$\eta_1$	$\eta_2$	$\eta_3$	$\eta_4$	$\eta_5$	$\eta_6$	$\eta_7$	$\eta_8$
Type	F	F	F	F	F	F	F	F
Default	none	none	none	none	none	none	none	none

Card 8            1            2            3            4            5            6            7            8

Variable	$\eta_9$	$\eta_{10}$	$\eta_{11}$	$\eta_{12}$	$\eta_{13}$			
Type	F	F	F	F	F			
Default	none	none	none	none	none			

**VARIABLE**

**DESCRIPTION**

- MID            Material identification. A unique number or label not exceeding 8 characters must be specified.
- RO            Mass density.
- PR            Poisson’s ratio.
- SIGF          Maximum principal stress for failure.
- A0            Cohesion.
- A1            Pressure hardening coefficient.
- A2            Pressure hardening coefficient.
- A0Y          Cohesion for yield
- A1Y          Pressure hardening coefficient for yield limit
- A2Y          Pressure hardening coefficient for yield limit
- A1F          Pressure hardening coefficient for failed material.
- A2F          Pressure hardening coefficient for failed material.
- B1            Damage scaling factor.
- B2            Damage scaling factor for uniaxial tensile path.
- B3            Damage scaling factor for triaxial tensile path.
- PER          Percent reinforcement.
- ER            Elastic modulus for reinforcement.
- PRR          Poisson’s ratio for reinforcement.

<u>VARIABLE</u>	<u>DESCRIPTION</u>
SIGY	Initial yield stress.
ETAN	Tangent modulus/plastic hardening modulus.
LCP	Load curve ID giving rate sensitivity for principal material, see *DEFINE_CURVE.
LCR	Load curve ID giving rate sensitivity for reinforcement, see *DEFINE_CURVE.
$\lambda_1$ - $\lambda_{13}$	Tabulated damage function
$\eta_1$ - $\eta_{13}$	Tabulated scale factor.

**Remarks:**

- Cohesion for failed material  $a_0f = 0.0$
- B3 must be positive or zero.
- $\lambda_n < \lambda_{n+1}$ . The first point must be zero.

## \*MAT\_CONCRETE\_DAMAGE\_REL3

This is Material Type 72. The Karagozian & Case (K&C) Concrete Model - Release III is a three-invariant model, uses three shear failure surfaces, includes damage and strain-rate effects, and has origins based on the Pseudo-TENSOR Model (Material Type 16). The most significant user improvement provided by Release III is a model parameter generation capability, based solely on the unconfined compression strength of the concrete. The implementation of Release III significantly changed the user input, thus previous input files using Material Type 72, i.e. prior to LS-DYNA Version 971, are not compatible with the present input format.

An open source reference, that precedes the parameter generation capability, is provided in Malvar et al. [1997]. A workshop proceedings reference, Malvar et al. [1996], is useful, but may be difficult to obtain. More recent, but *limited distribution* reference materials, e.g. Malvar et al. [2000], may be obtained by contacting Karagozian & Case.

Seven card images are required to define the *complete* set of model parameters for the K&C Concrete Model; an Equation-of-State is also required for the pressure-volume strain response. Brief descriptions of all the input parameters are provided below, however it is expected that this model will be used primarily with the option to generate the model parameters based on the unconfined compression strength of the concrete. The pressure-volume strain response for the model is also generated, in the form of a Tabulated Compaction Equation-of-State (EOS 8) whose parameters are also written to the LS-DYNA “message” file.

Card 1            1            2            3            4            5            6            7            8

Variable	MID	RO	PR					
Type	A8	F	F					
Default	none	none	none					

Card 2            1            2            3            4            5            6            7            8

Variable	FT	A0	A1	A2	B1	OMEGA	A1F	
Type	F	F	F	F	F	F	F	
Default	none	0.0	0.0	0.0	0.0	none	0.0	

Card 3            1            2            3            4            5            6            7            8

Variable	Sλ	NOUT	EDROP	RSIZE	UCF	LCRATE	LOCWID	NPTS
Type	F	F	F	F	F	F	F	F
Default	none	none	none	none	none	none	none	none

Card 4            1            2            3            4            5            6            7            8

Variable	λ01	λ02	λ03	λ04	λ05	λ06	λ07	λ08
Type	F	F	F	F	F	F	F	F
Default	none	none	none	none	none	none	none	none

Card 5            1            2            3            4            5            6            7            8

Variable	λ09	λ10	λ11	λ12	λ13	B3	A0Y	A1Y
Type	F	F	F	F	F	F	F	F
Default	none	none	none	none	none	none	0.0	0.0

Card 6            1            2            3            4            5            6            7            8

Variable	η01	η02	η03	η04	η05	η06	η07	η08
Type	F	F	F	F	F	F	F	F
Default	none	none	none	none	none	none	none	none



Card 7            1            2            3            4            5            6            7            8

Variable	$\eta_{09}$	$\eta_{10}$	$\eta_{11}$	$\eta_{12}$	$\eta_{13}$	B2	A2F	A2Y
Type	F	F	F	F	F	F	F	F
Default	none	none	none	none	none	0.0	0.0	0.0

**VARIABLE****DESCRIPTION**

MID	Material identification. A unique number or label not exceeding 8 characters must be specified.
RO	Mass density.
PR	Poisson's ratio, $\nu$ .
FT	Uniaxial tensile strength, $f_t$ .
A0	Maximum shear failure surface parameter, $a_0$ <b>or</b> $-f'_c$ for <b>parameter generation</b> (recommended).
A1	Maximum shear failure surface parameter, $a_1$ .
A2	Maximum shear failure surface parameter, $a_2$ .
B1	Compressive damage scaling parameter, $b_1$ .
OMEGA	Fractional dilatancy, $\omega$ .
A1F	Residual failure surface coefficient, $a_{1f}$ .
S $\lambda$	$\lambda$ stretch factor, $s$ .
NOUT	Output selector for effective plastic strain (see table).
EDROP	Post peak dilatancy decay, $N^\alpha$ .
RSIZE	Unit conversion factor for length (inches/user-unit), e.g. 39.37 if user length unit in meters.
UCF	Unit conversion factor for stress (psi/user-unit), e.g. 145 if $f'_c$ in MPa.

<b>VARIABLE</b>	<b>DESCRIPTION</b>
LCRATE	Define (load) curve number for strain-rate effects; effective strain rate on abscissa (negative = tension) and strength enhancement on ordinate.
LOCWID	Three times the maximum aggregate diameter (input in user length units).
NPTS	Number of points in $\lambda$ versus $\eta$ damage relation; must be 13 points.
$\lambda 01$	1 <sup>st</sup> value of damage function, $\lambda_1$
$\lambda 02$	2 <sup>nd</sup> value of damage function,
$\lambda 03$	3 <sup>rd</sup> value of damage function,
$\lambda 04$	4 <sup>th</sup> value of damage function,
$\lambda 05$	5 <sup>th</sup> value of damage function,
$\lambda 06$	6 <sup>th</sup> value of damage function,
$\lambda 07$	7 <sup>th</sup> value of damage function,
$\lambda 08$	8 <sup>th</sup> value of damage function,
$\lambda 09$	9 <sup>th</sup> value of damage function,
$\lambda 10$	10 <sup>th</sup> value of damage function,
$\lambda 11$	11 <sup>th</sup> value of damage function,
$\lambda 12$	12 <sup>th</sup> value of damage function,
$\lambda 13$	13 <sup>th</sup> value of damage function..
B3	Damage scaling coefficient for triaxial tension, $b_3$ .
A0Y	Initial yield surface cohesion, $a_{0y}$ .
A1Y	Initial yield surface coefficient, $a_{1y}$ .
$\eta 01$	1 <sup>st</sup> value of scale factor, $\eta_1$ .
$\eta 02$	2 <sup>nd</sup> value of scale factor,
$\eta 03$	3 <sup>rd</sup> value of scale factor,

VARIABLE	DESCRIPTION
η04	4 <sup>th</sup> value of scale factor,
η05	5 <sup>th</sup> value of scale factor,
η06	6 <sup>th</sup> value of scale factor,
η07	7 <sup>th</sup> value of scale factor,
η08	8 <sup>th</sup> value of scale factor,
η09	9 <sup>th</sup> value of scale factor,
η10	10 <sup>th</sup> value of scale factor,
η11	11 <sup>th</sup> value of scale factor,
η12	12 <sup>th</sup> value of scale factor,
η13	13 <sup>th</sup> value of scale factor.
B2	Tensile damage scaling exponent, $b_2$ .
A2F	Residual failure surface coefficient, $a_{2f}$ .
A2Y	Initial yield surface coefficient, $a_{2y}$ .

Output of Selected Variables

LS-PrePost will display the variable described in Table 72.1 when the effective plastic strain is selected, for the corresponding user input value of NOUT; see Card 3 above.

NOUT	Function	Description
1		Current shear failure surface radius
2	$\delta = 2\lambda / (\lambda + \lambda_m)$	Scaled damage measure
3	$\dot{\sigma}_{ij} \dot{\epsilon}_{ij}$	Strain energy (rate)
4	$\dot{\sigma}_{ij} \dot{\epsilon}_{ij}^p$	Plastic strain energy (rate)

**Table 72.1** Output variables for post-processing using NOUT parameter.

Sample Input for Concrete

As an example of the K&C Concrete Model material parameter generation, the following sample input for a 45.4 MPa (6,580 psi) unconfined compression strength concrete is provided. The basic units for the provided parameters are length in millimeters (mm), time in milliseconds

(msec), and mass in grams (g). This base unit set yields units of force in Newtons (N) and pressure in Mega-Pascals (MPa).

Card 1            1            2            3            4            5            6            7            8

Variable	MID	RO	PR					
Type	72	2.3E-3						

Card 2            1            2            3            4            5            6            7            8

Variable	FT	A0	A1	A2	B1	OMEGA	A1F	
Type		-45.4						

Card 3            1            2            3            4            5            6            7            8

Variable	Sλ	NOUT	EDROP	RSIZE	UCF	LCRATE	LOCWID	NPTS
Type				3.94E-2	145.0	723.0		

Card 4            1            2            3            4            5            6            7            8

Variable	λ01	λ02	λ03	λ04	λ05	λ06	λ07	λ08
Type								

Card 5            1            2            3            4            5            6            7            8

Variable	λ09	λ10	λ11	λ12	λ13	B3	A0Y	A1Y
Type								

Card 6            1            2            3            4            5            6            7            8

Variable	$\eta_{01}$	$\eta_{02}$	$\eta_{03}$	$\eta_{04}$	$\eta_{05}$	$\eta_{06}$	$\eta_{07}$	$\eta_{08}$
Type								

Card 7            1            2            3            4            5            6            7            8

Variable	$\eta_{09}$	$\eta_{10}$	$\eta_{11}$	$\eta_{12}$	$\eta_{13}$	B2	A2F	A2Y
Type								

Shear strength enhancement factor versus effective strain rate is given by a curve (\*DEFINE\_CURVE) with LCID 723. The sample input values, see Malvar & Ross [1998], are given in Table 72.2.

Strain-Rate (1/ms)	Enhancement
-3.0E+01	9.70
-3.0E-01	9.70
-1.0E-01	6.72
-3.0E-02	4.50
-1.0E-02	3.12
-3.0E-03	2.09
-1.0E-03	1.45
-1.0E-04	1.36
-1.0E-05	1.28
-1.0E-06	1.20
-1.0E-07	1.13
-1.0E-08	1.06
0.0E+00	1.00
3.0E-08	1.00
1.0E-07	1.03
1.0E-06	1.08
1.0E-05	1.14
1.0E-04	1.20
1.0E-03	1.26
3.0E-03	1.29
1.0E-02	1.33
3.0E-02	1.36
1.0E-01	2.04
3.0E-01	2.94
3.0E+01	2.94

**Table 72.2** Enhancement versus effective strain rate for 45.4 MPa concrete (sample). When defining curve LCRATE, input negative (tensile) values of effective strain rate first. The enhancement should be positive and should be 1.0 at a strain rate of zero.

\*MAT\_LOW\_DENSITY\_VISCOUS\_FOAM

This is Material Type 73 for Modeling Low Density Urethane Foam with high compressibility and with rate sensitivity which can be characterized by a relaxation curve. Its main applications are for seat cushions, padding on the Side Impact Dummies (SID), bumpers, and interior foams. Optionally, a tension cut-off failure can be defined. Also, see the notes below and the description of material 57: \*MAT\_LOW\_DENSITY\_FOAM.

Card 1            1            2            3            4            5            6            7            8

Variable	MID	RO	E	LCID	TC	HU	BETA	DAMP
Type	A8	F	F	F	F	F	F	F
Default					1.E+20	1.		
Remarks						3	1	

Card 2            1            2            3            4            5            6            7            8

Variable	SHAPE	FAIL	BVFLAG	KCON	LCID2	BSTART	TRAMP	NV
Type	F	F	F	F	F	F	F	I
Default	1.0	0.0	0.0	0.0	0	0.0	0.0	6

**If LCID2 = 0 then define the following viscoelastic constants. Up to 6 cards may be input. A keyword card (with a "\*" in column 1) terminates this input if less than 6 cards are used.**

Optional        1            2            3            4            5            6            7            8  
Cards

Variable	GI	BETAI	REF					
Type	F	F	F					

If LCID2 = -1 then define the following frequency dependent viscoelastic data.

Cards opt.      1                      2                      3                      4                      5                      6                      7                      8

Variable	LCID3	LCID4	SCALEW	SCALEA				
Type	I	I	I	I				

<u>VARIABLE</u>	<u>DESCRIPTION</u>
MID	Material identification. A unique number or label not exceeding 8 characters must be specified.
RO	Mass density
E	Young’s modulus used in tension. For implicit problems E is set to the initial slope of load curve LCID.
LCID	Load curve ID, see *DEFINE_CURVE, for nominal stress versus strain.
TC	Tension cut-off stress
HU	Hysteretic unloading factor between 0 and 1 (default=1, i.e., no energy dissipation), see also Figure 57.1.
BETA	$\beta$ , decay constant to model creep in unloading. EQ.0.0: No relaxation.
DAMP	Viscous coefficient (.05< recommended value <.50) to model damping effects. LT.0.0:  DAMP  is the load curve ID, which defines the damping constant as a function of the maximum strain in compression defined as: $\epsilon_{max} = \max(1 - \lambda_1, 1 - \lambda_2, 1 - \lambda_3)$ In tension, the damping constant is set to the value corresponding to the strain at 0. The abscissa should be defined from 0 to 1.
SHAPE	Shape factor for unloading. Active for nonzero values of the hysteretic unloading factor. Values less than one reduces the energy dissipation and greater than one increases dissipation, see also Figure 57.1.
FAIL	Failure option after cutoff stress is reached: EQ.0.0: tensile stress remains at cut-off value, EQ.1.0: tensile stress is reset to zero.



VARIABLE	DESCRIPTION
BVFLAG	Bulk viscosity activation flag, see remark below: EQ.0.0: no bulk viscosity (recommended), EQ.1.0: bulk viscosity active.
KCON	Stiffness coefficient for contact interface stiffness. Maximum slope in stress vs. strain curve is used. When the maximum slope is taken for the contact, the time step size for this material is reduced for stability. In some cases $\Delta t$ may be significantly smaller, and defining a reasonable stiffness is recommended.
LCID2	Load curve ID of relaxation curve. If constants $\beta_i$ are determined via a least squares fit. This relaxation curve is shown in Figure 76.1. This model ignores the constant stress.
BSTART	Fit parameter. In the fit, $\beta_1$ is set to zero, $\beta_2$ is set to BSTART, $\beta_3$ is 10 times $\beta_2$ , $\beta_4$ is 10 times greater than $\beta_3$ , and so on. If zero, BSTART=.01.
TRAMP	Optional ramp time for loading.
NV	Number of terms in fit. If zero, the default is 6. Currently, the maximum number is set to 6. Values of 2 or 3 are recommended, since each term used adds significantly to the cost. Caution should be exercised when taking the results from the fit. Preferably, all generated coefficients should be positive. Negative values may lead to unstable results. Once a satisfactory fit has been achieved it is recommended that the coefficients which are written into the output file be input in future runs.
GI	Optional shear relaxation modulus for the <i>i</i> th term
BETAI	Optional decay constant if <i>i</i> th term
REF	Use reference geometry to initialize the stress tensor. The reference geometry is defined by the keyword:*INITIAL_FOAM_REFERENCE_GEOMETRY (see there for more details). EQ.0.0: off, EQ.1.0: on.
LCID3	Load curve ID giving the magnitude of the shear modulus as a function of the frequency. LCID3 must use the same frequencies as LCID4.
LCID4	Load curve ID giving the phase angle of the shear modulus as a function of the frequency. LCID4 must use the same frequencies as LCID3.

VARIABLE	DESCRIPTION
SCALEW	Flag for the form of the frequency data. EQ.0.0: Frequency is in cycles per unit time. EQ.1.0: Circular frequency.
SCALEA	Flag for the units of the phase angle. EQ.0.0: Degrees. EQ.1.0: Radians.

**Remarks:**

This viscoelastic foam model is available to model highly compressible viscous foams. The hyperelastic formulation of this model follows that of Material 57.

Rate effects are accounted for through linear viscoelasticity by a convolution integral of the form

$$\sigma_{ij}^r = \int_0^t g_{ijkl}(t-\tau) \frac{\partial \epsilon_{kl}}{\partial \tau} d\tau$$

where  $g_{ijkl}(t-\tau)$  is the relaxation function. The stress tensor,  $\sigma_{ij}^r$ , augments the stresses determined from the foam,  $\sigma_{ij}^f$ ; consequently, the final stress,  $\sigma_{ij}$ , is taken as the summation of the two contributions:

$$\sigma_{ij} = \sigma_{ij}^f + \sigma_{ij}^r.$$

Since we wish to include only simple rate effects, the relaxation function is represented by up to six terms of the Prony series:

$$g(t) = \alpha_0 + \sum_{m=1}^N \alpha_m e^{-\beta t}$$

This model is effectively a Maxwell fluid which consists of a dampers and springs in series. The formulation is performed in the local system of principal stretches where only the principal values of stress are computed and triaxial coupling is avoided. Consequently, the one-dimensional nature of this foam material is unaffected by this addition of rate effects. The addition of rate effects necessitates 42 additional history variables per integration point. The cost and memory overhead of this model comes primarily from the need to “remember” the local system of principal stretches and the evaluation of the viscous stress components.

Frequency data can be fit to the Prony series. Using Fourier transforms the relationship between the relaxation function and the frequency dependent data is

$$G_s(\omega) = \alpha_0 + \sum_{m=1}^N \frac{\alpha_m (\omega / \beta_m)^2}{1 + (\omega / \beta_m)^2}$$

$$G_{\ell}(\omega) = \sum_{m=1}^N \frac{\alpha_m \omega / \beta_m}{1 + \omega / \beta_m}$$

where the storage modulus and loss modulus are defined in terms of the frequency dependent magnitude  $G$  and phase angle  $\phi$  given by load curves LCID3 and LCID4 respectively,

$$G_s(\omega) = G(\omega) \cos(\phi(\omega)), \text{ and } G_{\ell}(\omega) = G(\omega) \sin(\phi(\omega)).$$

**Additional Remarks:**

1. When hysteretic unloading is used the reloading will follow the unloading curve if the decay constant,  $\beta$ , is set to zero. If  $\beta$  is nonzero the decay to the original loading curve is governed by the expression:

$$1 - e^{-\beta t}$$

2. The bulk viscosity, which generates a rate dependent pressure, may cause an unexpected volumetric response and, consequently, it is optional with this model.
3. The hysteretic unloading factor results in the unloading curve to lie beneath the loading curve as shown in Figure 57.1. This unloading provides energy dissipation which is reasonable in certain kinds of foam.

**\*MAT\_ELASTIC\_SPRING\_DISCRETE\_BEAM**

This is Material Type 74. This model permits elastic springs with damping to be combined and represented with a discrete beam element type 6. Linear stiffness and damping coefficients can be defined, and, for nonlinear behavior, a force versus deflection and force versus rate curves can be used. Displacement based failure and an initial force are optional.

Card 1            1            2            3            4            5            6            7            8

Variable	MID	RO	K	F0	D	CDF	TDF	
Type	A8	F	F	F	F	F	F	

Card 2            1            2            3            4            5            6            7            8

Variable	FLCID	HLCID	C1	C2	DLE	GLCID		
Type	F	F	F	F	F	I		

<u>VARIABLE</u>	<u>DESCRIPTION</u>
MID	Material identification. A unique number or label not exceeding 8 characters must be specified.
RO	Mass density, see also volume in *SECTION_BEAM definition.
K	Stiffness coefficient.
F0	Optional initial force. This option is inactive if this material is referenced in a part referenced by material type *MAT_ELASTIC_6DOF_SPRING
D	Viscous damping coefficient.
CDF	Compressive displacement at failure. Input as a positive number. After failure, no forces are carried. This option does not apply to zero length springs. EQ.0.0: inactive.
TDF	Tensile displacement at failure. After failure, no forces are carried.
FLCID	Load curve ID, see *DEFINE_CURVE, defining force versus deflection for nonlinear behavior.

<u>VARIABLE</u>	<u>DESCRIPTION</u>
HLCID	Load curve ID, see *DEFINE_CURVE, defining force versus relative velocity for nonlinear behavior (optional). If the origin of the curve is at (0,0) the force magnitude is identical for a given magnitude of the relative velocity, i.e., only the sign changes.
C1	Damping coefficient for nonlinear behavior (optional).
C2	Damping coefficient for nonlinear behavior (optional).
DLE	Factor to scale time units. The default is unity.
GLCID	Optional load curve ID, see *DEFINE_CURVE, defining a scale factor versus deflection for load curve ID, HLCID. If zero, a scale factor of unity is assumed.

**Remarks:**

If the linear spring stiffness is used, the force,  $F$ , is given by:

$$F = F_0 + K\Delta L + D\Delta\dot{L}$$

but if the load curve ID is specified, the force is then given by:

$$F = F_0 + Kf(\Delta L) \left[ 1 + C1 \cdot \Delta\dot{L} + C2 \cdot \text{sgn}(\Delta\dot{L}) \ln \left( \max \left\{ 1., \frac{\Delta\dot{L}}{DLE} \right\} \right) \right] + D\Delta\dot{L} + g(\Delta L)h(\Delta\dot{L})$$

In these equations,  $\Delta L$  is the change in length

$$\Delta L = \text{current length} - \text{initial length}$$

The cross sectional area is defined on the section card for the discrete beam elements, See \*SECTION\_BEAM. The square root of this area is used as the contact thickness offset if these elements are included in the contact treatment.

**\*MAT\_BILKHU/DUBOIS\_FOAM**

This is Material Type 75. This model is for the simulation of isotropic crushable foams. Uniaxial and triaxial test data are used to describe the behavior.

Card 1            1            2            3            4            5            6            7            8

Variable	MID	RO	YM	LCPY	LCUYS	VC	PC	VPC
Type	A8	F	F	F	F	F	F	F

Card 2            1            2            3            4            5            6            7            8

Variable	TSC	VTSC	LCRATE	PR	KCON	ISFLG		
Type	I	F	F	F	F	F		

<u>VARIABLE</u>	<u>DESCRIPTION</u>
MID	Material identification. A unique number or label not exceeding 8 characters must be specified.
RO	Mass density
YM	Young's modulus (E)
LCPY	Load curve ID giving pressure for plastic yielding versus volumetric strain, see Figure 75.1.
LCUYS	Load curve ID giving uniaxial yield stress versus volumetric strain, see Figure 75.1, all abscissa should be positive if only the results of a compression test are included, optionally the results of a tensile test can be added (corresponding to negative values of the volumetric strain), in the latter case PC, VPC, TC and VTC will be ignored
VC	Viscous damping coefficient (.05<recommended value<.50).
PC	Pressure cutoff. If zero, the default is set to one-tenth of $p_0$ , the yield pressure corresponding to a volumetric strain of zero.
VPC	Variable pressure cutoff as a fraction of pressure yield value. If non-zero this will override the pressure cutoff value PC.

<u>VARIABLE</u>	<u>DESCRIPTION</u>
TC	Tension cutoff for uniaxial tensile stress. Default is zero. A nonzero value is recommended for better stability.
VTC	Variable tension cutoff as a fraction of the uniaxial compressive yield strength, if non-zero this will override the tension cutoff value TC.
LCRATE	Load curve ID giving a scale factor for the previous yield curves, dependent upon the volumetric plastic strain.
PR	Poisson coefficient, which applies to both elastic and plastic deformations, must be smaller than 0.5
KCON	Stiffness coefficient for contact interface stiffness. If undefined one-third of Young's modulus, YM, is used. KCON is also considered in the element time step calculation; therefore, large values may reduce the element time step size.
ISFLG	Flag for tensile response (active only if negative abscissa are present in load curve LCUYS) EQ.0: load curve abscissa in tensile region correspond to volumetric strain EQ.1: load curve abscissa in tensile region correspond to effective strain

### **Remarks:**

The logarithmic volumetric strain is defined in terms of the relative volume,  $V$ , as:

$$\gamma = -\ln(V)$$

If used (ISFLG-1), the effective strain is defined in the usual way:

$$\varepsilon_{eff} = \sqrt{\frac{2}{3} \varepsilon : \varepsilon}$$

In defining the load curve LCPY the stress and strain pairs should be positive values starting with a volumetric strain value of zero.

The load curve LCUYS can optionally contain the results of the tensile test (corresponding to negative values of the volumetric strain), if so, then the load curve information will override PC, VPC, TC and VTC

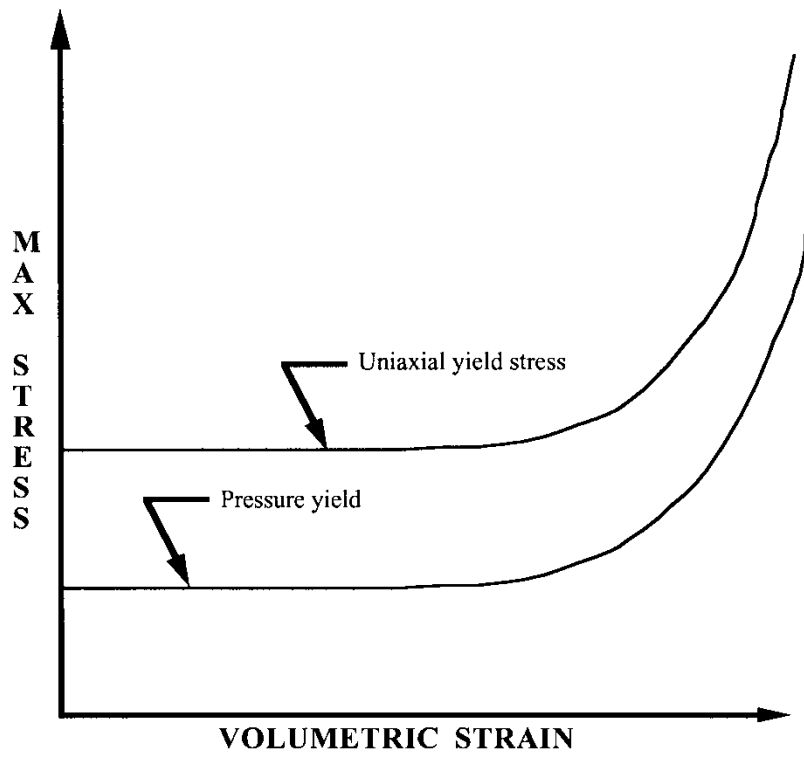

**Figure 75.1.** Behavior of crushable foam. Unloading is elastic.

The yield surface is defined as an ellipse in the equivalent pressure and von Mises stress plane.



\*MAT\_GENERAL\_VISCOELASTIC

This is Material Type 76. This material model provides a general viscoelastic Maxwell model having up to 18 terms in the prony series expansion and is useful for modeling dense continuum rubbers and solid explosives. Either the coefficients of the prony series expansion or a relaxation curve may be specified to define the viscoelastic deviatoric and bulk behavior.

The material model can also be used with laminated shell. Either an elastic or viscoelastic layer can be defined with the laminated formulation. To activate laminated shell you need the laminated formulation flag on \*CONTROL\_SHELL. With the laminated option a user defined integration rule is needed.

Card 1            1            2            3            4            5            6            7            8

Variable	MID	RO	BULK	PCF	EF	TREF	A	B
Type	A8	F	F	F	F	F	F	F

**Insert a blank card here if constants are defined on cards 3,4,... below.**

**If an elastic layer is defined in a laminated shell this card must be blank.**

Card 2            1            2            3            4            5            6            7            8

Variable	LCID	NT	BSTART	TRAMP	LCIDK	NTK	BSTART K	TRAMPK
Type	F	I	F	F	F	I	F	F

**Card Format for viscoelastic constants. Up to 18 cards may be input. A keyword card (with a "\*" in column 1) terminates this input if less than 6 cards are used. These cards are not needed if relaxation data is defined. The number of terms for the shear behavior may differ from that for the bulk behavior: simply insert zero if a term is not included. If an elastic layer is defined you only need to define GI and KI (note in an elastic layer only one card is needed)**

Cards opt.       1            2            3            4            5            6            7            8

Variable	GI	BETAI	KI	BETAKI				
Type	F	F	F	F				

<b>VARIABLE</b>	<b>DESCRIPTION</b>
MID	Material identification. A unique number or label not exceeding 8 characters must be specified.
RO	Mass density.
BULK	Elastic bulk modulus.
PCF	Tensile pressure elimination flag for solid elements only. If set to unity tensile pressures are set to zero.
EF	Elastic flag (if equal 1, the layer is elastic. If 0 the layer is viscoelastic).
TREF	Reference temperature for shift function (must be greater than zero).
A	Coefficient for the Arrhenius and the Williams-Landau-Ferry shift functions.
B	Coefficient for the Williams-Landau-Ferry shift function.
LCID	Load curve ID for deviatoric behavior if constants, $G_i$ , and $\beta_i$ are determined via a least squares fit. This relaxation curve is shown below.
NT	Number of terms in shear fit. If zero the default is 6. Fewer than NT terms will be used if the fit produces one or more negative shear moduli. Currently, the maximum number is set to 18.
BSTART	In the fit, $\beta_1$ is set to zero, $\beta_2$ is set to BSTART, $\beta_3$ is 10 times $\beta_2$ , $\beta_4$ is 10 times $\beta_3$ , and so on. If zero, BSTART is determined by an iterative trial and error scheme.
TRAMP	Optional ramp time for loading.
LCIDK	Load curve ID for bulk behavior if constants, $K_i$ , and $\beta_{\kappa_i}$ are determined via a least squares fit. This relaxation curve is shown below.
NTK	Number of terms desired in bulk fit. If zero the default is 6. Currently, the maximum number is set to 18.
BSTARTK	In the fit, $\beta_{\kappa_1}$ is set to zero, $\beta_{\kappa_2}$ is set to BSTARTK, $\beta_{\kappa_3}$ is 10 times $\beta_{\kappa_2}$ , $\beta_{\kappa_4}$ is 100 times greater than $\beta_{\kappa_3}$ , and so on. If zero, BSTARTK is determined by an iterative trial and error scheme.
TRAMPK	Optional ramp time for bulk loading.
GI	Optional shear relaxation modulus for the <i>i</i> th term

VARIABLE	DESCRIPTION
BETA1	Optional shear decay constant for the 1th term
K1	Optional bulk relaxation modulus for the 1th term
BETA1K1	Optional bulk decay constant for the 1th term

**Remarks:**

Rate effects are taken into account through linear viscoelasticity by a convolution integral of the form:

$$\sigma_{ij} = \int_0^t g_{ijkl}(t-\tau) \frac{\partial \varepsilon_{kl}}{\partial \tau} d\tau$$

where  $g_{ijkl}(t-\tau)$  is the relaxation functions for the different stress measures. This stress is added to the stress tensor determined from the strain energy functional.

If we wish to include only simple rate effects, the relaxation function is represented by six terms from the Prony series:

$$g(t) = \sum_{m=1}^N G_m e^{-\beta_m t}$$

We characterize this in the input by shear moduli,  $G_i$ , and decay constants,  $\beta_i$ . An arbitrary number of terms, up to 18, may be used when applying the viscoelastic model.

For volumetric relaxation, the relaxation function is also represented by the Prony series in terms of bulk moduli:

$$k(t) = \sum_{m=1}^N K_m e^{-\beta_{km} t}$$

The Arrhenius and Williams-Landau-Ferry (WLF) shift functions account for the effects of the temperature on the stress relaxation. A scaled time,  $t'$ ,

$$t' = \int_0^t \Phi(T) dt$$

is used in the relaxation function instead of the physical time. The Arrhenius shift function is

$$\Phi(T) = \exp\left(-A\left\{\frac{1}{T} - \frac{1}{T_{REF}}\right\}\right)$$

and the Williams-Landau-Ferry shift function is

$$\Phi(T) = \exp\left(-A \frac{T - T_{REF}}{B + T - T_{REF}}\right)$$

If all three values (TREF, A, and B) are not zero, the WLF function is used; the Arrhenius function is used if B is zero; and no scaling is applied if all three values are zero.

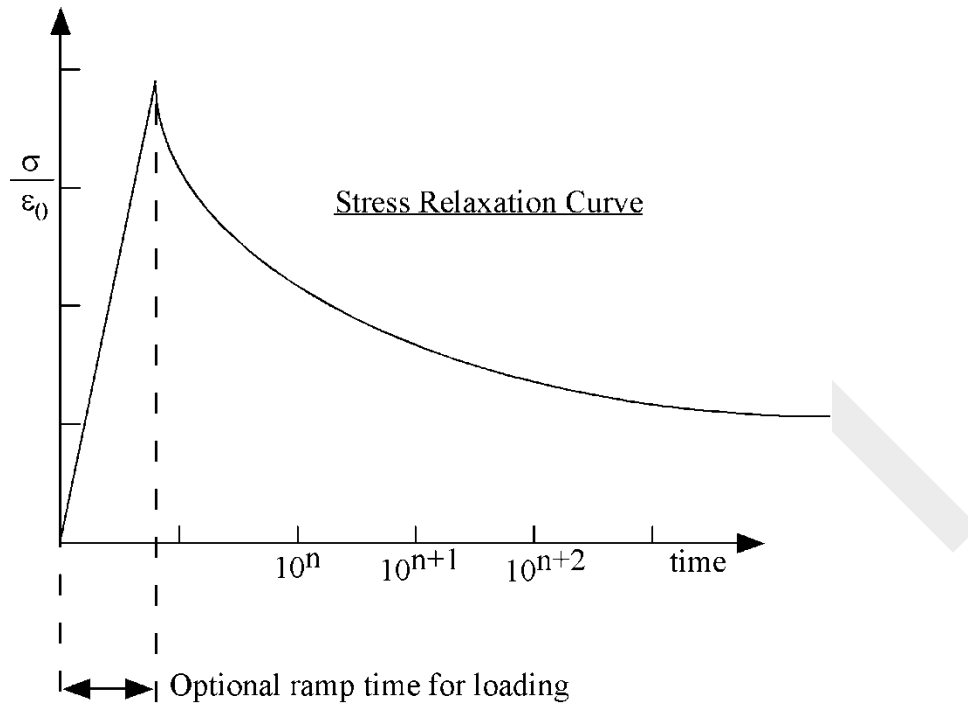

**Figure 76.1.** Relaxation curve. This curve defines stress versus time where time is defined on a logarithmic scale. For best results, the points defined in the load curve should be equally spaced on the logarithmic scale. Note the values for the abscissa are input as time, not log(time). Furthermore, the load curve should be smooth and defined in the positive quadrant. If nonphysical values are determined by least squares fit, LS-DYNA will terminate with an error message after the initialization phase is completed. If the ramp time for loading is included, then the relaxation which occurs during the loading phase is taken into account. This effect may or may not be important.

\*MAT\_HYPERELASTIC\_RUBBER

This is Material Type 77. This material model provides a general hyperelastic rubber model combined optionally with linear viscoelasticity as outlined by Christensen [1980].

Card 1            1            2            3            4            5            6            7            8

Variable	MID	RO	PR	N	NV	G	SIGF	REF
Type	A8	F	F	I	I	F	F	F

**Extra card to read table for Mullins effect if PR.LT.0**

Card opt.        1            2            3            4            5            6            7            8

Variable	TBHYS							
Type	F							

**Card 2 if N > 0, a least squares fit is computed from uniaxial data**

Card 2            1            2            3            4            5            6            7            8

Variable	SGL	SW	ST	LCID1	DATA	LCID2	BSTART	TRAMP
Type	F	F	F	F	F	F	F	F

**Card 2 if N = 0 define the following constants**

Card 2            1            2            3            4            5            6            7            8

Variable	C10	C01	C11	C20	C02	C30		
Type	F	F	F	F	F	F		

**Card Format for Viscoelastic Constants and frictional damping constants. Up to 12 cards may be input. A keyword card (with a “\*” in column 1) terminates this input if less than 12 cards are used.**

Cards opt.      1            2            3            4            5            6            7            8

Variable	GI	BETAI	GJ	SIGFJ				
Type	F	F	F	F				

<u>VARIABLE</u>	<u>DESCRIPTION</u>
MID	Material identification. A unique number or label not exceeding 8 characters must be specified.
RO	Mass density
PR	Poissons ratio (>.49 is recommended, smaller values may not work and should not be used). If this is set to a negative number, then the absolute value is used and an extra card is read for Mullins effect.
TBHYS	Table ID for hysteresis, see Remarks
N	Number of constants to solve for: EQ.1: Solve for C10 and C01 EQ.2: Solve for C10, C01, C11, C20, and C02 EQ.3: Solve for C10, C01, C11, C20, C02, and C30
NV	Number of Prony series terms in fit. If zero, the default is 6. Currently, the maximum number is set to 12. Values less than 12, possibly 3-5 are recommended, since each term used adds significantly to the cost. Caution should be exercised when taking the results from the fit. Preferably, all generated coefficients should be positive. Negative values may lead to unstable results. Once a satisfactory fit has been achieved it is recommended that the coefficients which are written into the output file be input in future runs.
G	Shear modulus for frequency independent damping. Frequency independent damping is based of a spring and slider in series. The critical stress for the slider mechanism is SIGF defined below. For the best results, the value of G should be 250-1000 times greater than SIGF.
SIGF	Limit stress for frequency independent frictional damping.

VARIABLE	DESCRIPTION
REF	Use reference geometry to initialize the stress tensor. The reference geometry is defined by the keyword:*INITIAL_FOAM_REFERENCE_GEOMETRY (see there for more details). EQ.0.0: off, EQ.1.0: on.

**If N>0 test information from a uniaxial test are used.**

SGL	Specimen gauge length
SW	Specimen width
ST	Specimen thickness
LCID1	Load curve ID giving the force versus actual change in the gauge length
DATA	Type of experimental data. EQ.0.0: uniaxial data (Only option for this model)
LCID2	Load curve ID of relaxation curve If constants $\beta_i$ are determined via a least squares fit. This relaxation curve is shown in Figure 76.1. This model ignores the constant stress.
BSTART	In the fit, $\beta_1$ is set to zero, $\beta_2$ is set to BSTART, $\beta_3$ is 10 times $\beta_2$ , $\beta_4$ is 10 times $\beta_3$ , and so on. If zero, BSTART is determined by an iterative trial and error scheme.
TRAMP	Optional ramp time for loading.

**If N=0, the following constants have to be defined:**

C10	C <sub>10</sub>
C01	C <sub>01</sub>
C11	C <sub>11</sub>
C20	C <sub>20</sub>
C02	C <sub>02</sub>
C30	C <sub>30</sub>
GI	Optional shear relaxation modulus for the ith term

VARIABLE	DESCRIPTION
BETA1	Optional decay constant if 1th term
GJ	Optional shear modulus for frequency independent damping represented as the jth spring and slider in series in parallel to the rest of the stress contributions.
SIGFJ	Limit stress for frequency independent, frictional, damping represented as the jth spring and slider in series in parallel to the rest of the stress contributions.

**Remarks:**

Rubber is generally considered to be fully incompressible since the bulk modulus greatly exceeds the shear modulus in magnitude. To model the rubber as an unconstrained material a hydrostatic work term,  $W_H(J)$ , is included in the strain energy functional which is function of the relative volume,  $J$ , [Ogden 1984]:

$$W(J_1, J_2, J) = \sum_{p,q=0}^n C_{pq} (J_1 - 3)^p (J_2 - 3)^q + W_H(J)$$

$$J_1 = I_1 I_3^{-1/3}$$

$$J_2 = I_2 I_3^{-2/3}$$

In order to prevent volumetric work from contributing to the hydrostatic work the first and second invariants are modified as shown. This procedure is described in more detail by Sussman and Bathe [1987].

Rate effects are taken into account through linear viscoelasticity by a convolution integral of the form:

$$\sigma_{ij} = \int_0^t g_{ijkl}(t - \tau) \frac{\partial \epsilon_{kl}}{\partial \tau} d\tau$$

or in terms of the second Piola-Kirchhoff stress,  $S_{ij}$ , and Green's strain tensor,  $E_{ij}$ ,

$$S_{ij} = \int_0^t G_{ijkl}(t - \tau) \frac{\partial E_{kl}}{\partial \tau} d\tau$$

where  $g_{ijkl}(t - \tau)$  and  $G_{ijkl}(t - \tau)$  are the relaxation functions for the different stress measures. This stress is added to the stress tensor determined from the strain energy functional.

If we wish to include only simple rate effects, the relaxation function is represented by six terms from the Prony series:



$$g(t) = \alpha_0 + \sum_{m=1}^N \alpha_m e^{-\beta t}$$

given by,

$$g(t) = \sum_{i=1}^n G_i e^{-\beta_i t}$$

This model is effectively a Maxwell fluid which consists of a dampers and springs in series. We characterize this in the input by shear moduli,  $G_i$ , and decay constants,  $\beta_i$ . The viscoelastic behavior is optional and an arbitrary number of terms may be used.

The Mooney-Rivlin rubber model (model 27) is obtained by specifying  $n=1$ . In spite of the differences in formulations with Model 27, we find that the results obtained with this model are nearly identical with those of Material 27 as long as large values of Poisson's ratio are used.

The frequency independent damping is obtained by the having a spring and slider in series as shown in the following sketch:

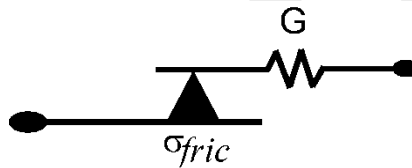

Several springs and sliders in series can be defined that are put in parallel to the rest of the stress contributions of this material model.

If a table for hysteresis is defined, then this is interpreted as follows. Let  $W_{dev}$  be the current value of the deviatoric strain energy density as calculated above. Furthermore, let  $\bar{W}_{dev}$  be the peak strain energy density reached up to this point in time. It is then assumed that the resulting stress is reduced by a factor due to damage according to

$$\mathbf{S} = D(W_{dev}, \bar{W}_{dev}) \frac{\partial W_{dev}}{\partial \mathbf{E}} + \frac{\partial W_{vol}}{\partial \mathbf{E}}$$

i.e., the deviatoric stress is reduced by damage factor that is given as input. The table should thus consist of curves for different values of  $\bar{W}_{dev}$ , where each curve gives the stress reduction (a value between 0 and 1) for a given value of  $W_{dev}$ . The abscissa values for a curve corresponding to a peak energy density of  $\bar{W}_{dev}$  should range from 0 to  $\bar{W}_{dev}$ , and the ordinate values should preferably increase with increasing  $W_{dev}$  and must take the value 1 when  $W_{dev} = \bar{W}_{dev}$ . This table can be estimated from a uniaxial quasistatic compression test. Let a test specimen of volume  $V$  be loaded and unloaded one cycle. We assume  $f(d)$  to be the loading force as function of the displacement  $d$ , and  $f_u(d)$  be the unloading curve. The specimen is loaded to maximum displacement  $\bar{d}$  before unloading. The strain energy density is then given as a function of the loaded displacement as

$$W_{\text{dev}}(d) = \frac{1}{V} \int_0^d f(s) ds$$

and the peak energy is of course given as  $\bar{W}_{\text{dev}} = W_{\text{dev}}(\bar{d})$ . From this energy curve we can also determine the inverse, i.e., the displacement  $d(W_{\text{dev}})$ . The curve to be input to LS-DYNA is then

$$D(W_{\text{dev}}, \bar{W}_{\text{dev}}) = \frac{f_u(d(W_{\text{dev}}))}{f(d(W_{\text{dev}}))}$$

This procedure is repeated for different values of  $\bar{d}$ .

\*MAT\_OGDEN\_RUBBER

This is also Material Type 77. This material model provides the Ogden [1984] rubber model combined optionally with linear viscoelasticity as outlined by Christensen [1980].

Card 1            1            2            3            4            5            6            7            8

Variable	MID	RO	PR	N	NV	G	SIGF	REF
Type	A8	F	F	I	I	F	F	F

**Extra card to read table for Mullins effect if PR.LT.0**

Card opt.	1	2	3	4	5	6	7	8
Variable	TBHYS							
Type	F							

**Card 2 if N > 0, a least squares fit is computed from uniaxial data**

Card 2            1            2            3            4            5            6            7            8

Variable	SGL	SW	ST	LCID1	DATA	LCID2	BSTART	TRAMP
Type	F	F	F	F	F	F		F

**Cards 2,3 if N = 0 define the following constants**

Card 2            1            2            3            4            5            6            7            8

Variable	MU1	MU2	MU3	MU4	MU5	MU6	MU7	MU8
Type	F	F	F	F	F	F	F	F

Card 3            1            2            3            4            5            6            7            8

Variable	ALPHA1	ALPHA2	ALPHA3	ALPHA4	ALPHA5	ALPHA6	ALPHA7	ALPHA8
Type	F	F	F	F	F	F	F	F

**Card Format for Viscoelastic Constants. Up to 12 cards may be input. A keyword card (with a "\*" in column 1) terminates this input if less than 12 cards are used.**

Cards opt.        1            2            3            4            5            6            7            8

Variable	GI	BETA1						
Type	F	F						

<u>VARIABLE</u>	<u>DESCRIPTION</u>
MID	Material identification. A unique number or label not exceeding 8 characters must be specified.
RO	Mass density
PR	Poissons ratio ( $\geq .49$ is recommended; smaller values may not work and should not be used). If this is set to a negative number, then the absolute value is used and an extra card is read for Mullins effect.
N	Order of fit to the Ogden model, (currently $< 9$ , 2 generally works okay). The constants generated during the fit are printed in the output file and can be directly input in future runs, thereby, saving the cost of performing the nonlinear fit. The users need to check the correction of the fit results before proceeding to compute.
NV	Number of Prony series terms in fit. If zero, the default is 6. Currently, the maximum number is set to 12. Values less than 12, possibly 3-5 are recommended, since each term used adds significantly to the cost. Caution should be exercised when taking the results from the fit. Preferably, all generated coefficients should be positive. Negative values may lead to unstable results. Once a satisfactory fit has been achieved it is recommended that the coefficients which are written into the output file be input in future runs.

VARIABLE	DESCRIPTION
G	Shear modulus for frequency independent damping. Frequency independent damping is based on a spring and slider in series. The critical stress for the slider mechanism is SIGF defined below. For the best results, the value of G should be 250-1000 times greater than SIGF.
SIGF	Limit stress for frequency independent frictional damping.
REF	Use reference geometry to initialize the stress tensor. The reference geometry is defined by the keyword: *INITIAL_FOAM_REFERENCE_GEOMETRY (see there for more details). EQ.0.0: off, EQ.1.0: on.
TBHYS	Table ID for hysteresis, see Remarks on MAT_HYPERELASTIC_RUBBER

**If N>0 test information from a uniaxial test are used:**

SGL	Specimen gauge length
SW	Specimen width
ST	Specimen thickness
LCID1	Load curve ID giving the force versus actual change in the gauge length
DATA	Type of experimental data. EQ.1.0: uniaxial data (default) EQ.2.0: biaxial data EQ.3.0: pure shear data
LCID2	Load curve ID of relaxation curve. If constants $\beta_i$ are determined via a least squares fit. This relaxation curve is shown in Figure 76.1. This model ignores the constant stress.
BSTART	In the fit, $\beta_1$ is set to zero, $\beta_2$ is set to BSTART, $\beta_3$ is 10 times $\beta_2$ , $\beta_4$ is 10 times $\beta_3$ , and so on. If zero, BSTART is determined by an iterative trial and error scheme.
TRAMP	Optional ramp time for loading. If N=0, the constants $MU_i$ and $ALPHA_i$ have to be defined:
MU <sub>i</sub>	$\mu_i$ , the <i>i</i> th shear modulus, <i>i</i> varies up to 8. See discussion below.
ALPHA <sub>i</sub>	$\alpha_i$ , the <i>i</i> th exponent, <i>i</i> varies up to 8. See discussion below.

VARIABLE	DESCRIPTION
GI	Optional shear relaxation modulus for the ith term
BETAI	Optional decay constant if ith term
VFLAG	Flag for the viscoelasticity formulation. This appears only on the first line defining GI, BETAI, and VFLAG. If VFLAG=0, the standard viscoelasticity formulation is used (the default), and if VFLAG=1, the viscoelasticity formulation using the instantaneous elastic stress is used.

**Remarks:**

Rubber is generally considered to be fully incompressible since the bulk modulus greatly exceeds the shear modulus in magnitude. To model the rubber as an unconstrained material a hydrostatic work term is included in the strain energy functional which is function of the relative volume,  $J$ , [Ogden 1984]:

$$W^* = \sum_{i=1}^3 \sum_{j=1}^n \frac{\mu_j}{\alpha_j} (\lambda_i^{*\alpha_j} - 1) + K(J - 1 - \ln J)$$

The asterisk (\*) indicates that the volumetric effects have been eliminated from the principal stretches,  $\lambda_j^*$ . The number of terms,  $n$ , may vary between 1 to 8 inclusive, and  $K$  is the bulk modulus.

Rate effects are taken into account through linear viscoelasticity by a convolution integral of the form:

$$\sigma_{ij} = \int_0^t g_{ijkl}(t - \tau) \frac{\partial \varepsilon_{kl}}{\partial \tau} d\tau$$

or in terms of the second Piola-Kirchhoff stress,  $\{S_0\}$ , and Green's strain tensor,  $\{S_{RT}\}$ ,

$$S_{ij} = \int_0^t G_{ijkl}(t - \tau) \frac{\partial E_{kl}}{\partial \tau} d\tau$$

where  $g_{ijkl}(t - \tau)$  and  $G_{ijkl}(t - \tau)$  are the relaxation functions for the different stress measures. This stress is added to the stress tensor determined from the strain energy functional.

If we wish to include only simple rate effects, the relaxation function is represented by six terms from the Prony series:

$$g(t) = \alpha_0 + \sum_{m=1}^N \alpha_m e^{-\beta t}$$

given by,

$$g(t) = \sum_{i=1}^n G_i e^{-\beta_i t}$$

This model is effectively a Maxwell fluid which consists of a dampers and springs in series. We characterize this in the input by shear moduli,  $G_i$ , and decay constants,  $\beta_i$ . The viscoelastic behavior is optional and an arbitrary number of terms may be used.

For VFLAG=1, the viscoelastic term is

$$\sigma_{ij} = \int_0^t g_{ijkl}(t - \tau) \frac{\partial \sigma_{kl}^E}{\partial \tau} d\tau$$

where  $\sigma_{kl}^E$  is the instantaneous stress evaluated from the internal energy functional. The coefficients in the Prony series therefore correspond to normalized relaxation moduli instead of elastic moduli.

The Mooney-Rivlin rubber model (model 27) is obtained by specifying  $n=1$ . In spite of the differences in formulations with Model 27, we find that the results obtained with this model are nearly identical with those of Material 27 as long as large values of Poisson's ratio are used.

The frequency independent damping is obtained by the having a spring and slider in series as shown in the following sketch:

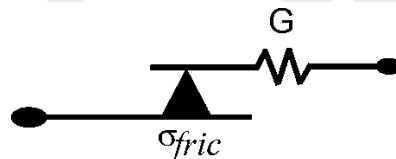

**\*MAT\_SOIL\_CONCRETE**

This is Material Type 78. This model permits concrete and soil to be efficiently modeled. See the explanations below.

Card 1            1            2            3            4            5            6            7            8

Variable	MID	RO	G	K	LCPV	LCYP	LCFP	LCRP
Type	A8	F	F	F	F	F	F	F

Card 2            1            2            3            4            5            6            7            8

Variable	PC	OUT	B	FAIL				
Type	F	F	F	F				

<u>VARIABLE</u>	<u>DESCRIPTION</u>
MID	Material identification. A unique number or label not exceeding 8 characters must be specified.
RO	Mass density
G	Shear modulus
K	Bulk modulus
LCPV	Load curve ID for pressure versus volumetric strain. The pressure versus volumetric strain curve is defined in compression only. The sign convention requires that both pressure and compressive strain be defined as positive values where the compressive strain is taken as the negative value of the natural logarithm of the relative volume.
LCYP	Load curve ID for yield versus pressure: GT.0: von Mises stress versus pressure, LT.0: Second stress invariant, $J_2$ , versus pressure. This curve must be defined.
LCFP	Load curve ID for plastic strain at which fracture begins versus pressure. This load curve ID must be defined if $B > 0.0$ .



VARIABLE	DESCRIPTION
LCRP	Load curve ID for plastic strain at which residual strength is reached versus pressure. This load curve ID must be defined if B>0.0.
PC	Pressure cutoff for tensile fracture
OUT	Output option for plastic strain in database: EQ.0: volumetric plastic strain, EQ.1: deviatoric plastic strain.
B	Residual strength factor after cracking, see Figure 78.1.
FAIL	Flag for failure: EQ.0: no failure, EQ.1: When pressure reaches failure pressure element is eroded, EQ.2: When pressure reaches failure pressure element loses it ability to carry tension.

### **Remarks:**

Pressure is positive in compression. Volumetric strain is defined as the natural log of the relative volume and is *positive* in compression where the relative volume,  $V$ , is the ratio of the current volume to the initial volume. The tabulated data should be given in order of increasing compression. If the pressure drops below the cutoff value specified, it is reset to that value and the deviatoric stress state is eliminated.

If the load curve ID (LCYP) is provided as a positive number, the deviatoric, perfectly plastic, pressure dependent, yield function  $\phi$ , is given as

$$\phi = \sqrt{3J_2} - F(p) = \sigma_y - F(p)$$

where,  $F(p)$  is a tabulated function of yield stress versus pressure, and the second invariant,  $J_2$ , is defined in terms of the deviatoric stress tensor as:

$$J_2 = \frac{1}{2} S_{ij} S_{ij}$$

assuming that if the ID is given as negative then the yield function becomes:

$$\phi = J_2 - F(p)$$

being the deviatoric stress tensor.

If cracking is invoked by setting the residual strength factor, B, on card 2 to a value between 0.0 and 1.0, the yield stress is multiplied by a factor  $f$  which reduces with plastic strain according to a trilinear law as shown in Figure 78.1.

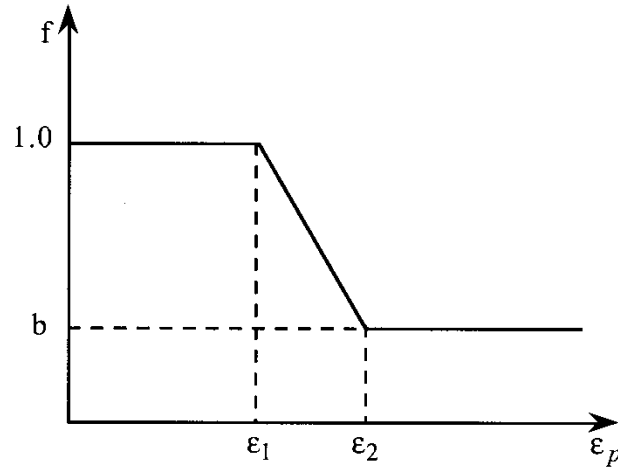

Figure 78.1. Strength reduction factor.

- b = residual strength factor
- $\epsilon_1$  = plastic stain at which cracking begins.
- $\epsilon_2$  = plastic stain at which residual strength is reached.

$\epsilon_1$  and  $\epsilon_2$  are tabulated functions of pressure that are defined by load curves, see Figure 78.2. The values on the curves are pressure versus strain and should be entered in order of increasing pressure. The strain values should always increase monotonically with pressure.

By properly defining the load curves, it is possible to obtain the desired strength and ductility over a range of pressures, see Figure 78.3.

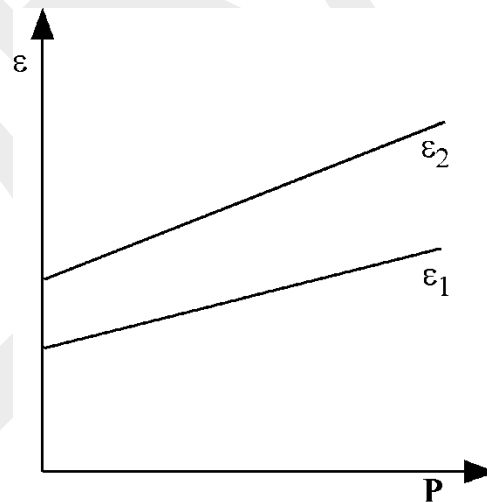

Figure 78.2. Cracking strain versus pressure.

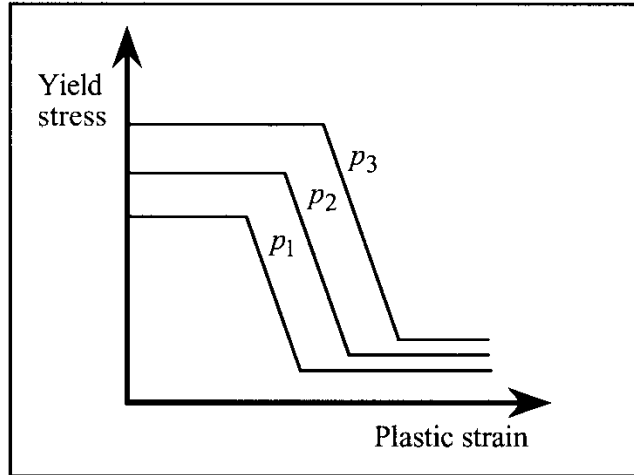

Figure 78.3.

**\*MAT\_HYSTERETIC\_SOIL**

This is Material Type 79. This model is a nested surface model with up to ten superposed “layers” of elasto-perfectly plastic material, each with its own elastic moduli and yield values. Nested surface models give hysteric behavior, as the different “layers” yield at different stresses. See Remarks below.

Note: This Material Type will be available starting in release 3 of version 971.

Card 1            1            2            3            4            5            6            7            8

Variable	MID	RO	K0	P0	B	A0	A1	A2
Type	A8	F	F	F	F	F	F	F

Card 2            1            2            3            4            5            6            7            8

Variable	DF	RP	LCID	SFLC	DIL_A	DIL_B	DIL_C	DIL_D
Type	F	F	F	F	F	F	F	F

Card 3            1            2            3            4            5            6            7            8

Variable	GAM1	GAM2	GAM3	GAM4	GAM5			PINIT
Type	F	F	F	F	F			I

Card 4            1            2            3            4            5            6            7            8

Variable	TAU1	TAU2	TAU3	TAU4	TAU5			
Type	F	F	F	F	F			

VARIABLE	DESCRIPTION
MID	Material identification. A unique number or label not exceeding 8 characters must be specified.
RO	Mass density
K0	Bulk modulus at the reference pressure
P0	Cut-off/datum pressure (must be $0 \leq$ i.e. tensile). Below this pressure, stiffness and strength disappears; this is also the “zero” pressure for pressure-varying properties.
B	Exponent for pressure-sensitive moduli, b: $G = G_0 (p - p_o)^b$ $K = K_0 (p - p_o)^b$ . b, must lie in the range $0 \leq b < 1$ . Values close to 1 are not recommended because the pressure becomes indeterminate.
A0	Yield function constant $a_0$ (Default = 1.0), see Material Type 5.
A1	Yield function constant $a_1$ (Default = 0.0), see Material Type 5.
A2	Yield function constant $a_2$ (Default = 0.0), see Material Type 5.
DF	Damping factor. Must be in the range $0 \leq df \leq 1$ : EQ.0: no damping, EQ.1: maximum damping.
RP	Reference pressure for following input data.
LCID	Load curve ID defining shear strain versus shear stress. Up to ten points may be defined in the load curve. See *DEFINE_CURVE.
SFLD	Scale factor to apply to shear stress in LCID.
DIL_A	Dilation parameter A
DIL_B	Dilation parameter B
DIL_C	Dilation parameter C
DIL_D	Dilation parameter D
GAM1	$\gamma_1$ , shear strain (ignored if LCID is non zero).
GAM2	$\gamma_2$ , shear strain (ignored if LCID is non zero).

VARIABLE	DESCRIPTION
GAM3	$\gamma_3$ , shear strain (ignored if LCID is non zero).
GAM4	$\gamma_4$ , shear strain (ignored if LCID is non zero).
GAM5	$\gamma_5$ , shear strain (ignored if LCID is non zero).
TAU1	$\tau_1$ , shear stress at $\gamma_1$ (ignored if LCID is non zero).
TAU2	$\tau_2$ , shear stress at $\gamma_2$ (ignored if LCID is non zero).
TAU3	$\tau_3$ , shear stress at $\gamma_3$ (ignored if LCID is non zero).
TAU4	$\tau_4$ , shear stress at $\gamma_4$ (ignored if LCID is non zero).
TAU5	$\tau_5$ , shear stress at $\gamma_5$ (ignored if LCID is non zero).
PINIT	Flag for pressure sensitivity (B and A0, A1, A2 equations): EQ.0: Use current pressure (will vary during the analysis) EQ.1: Use pressure from initial stress state EQ.2: Use initial "plane stress" pressure $(\sigma_v + \sigma_h)/2$ EQ.3: Use (compressive) initial vertical stress

**Remarks:**

The elastic moduli G and K are pressure sensitive:

$$G(p) = \frac{G_0 (p - p_0)^b}{(p_{ref} - p_0)^b}$$

$$K(p) = \frac{K_0 (p - p_0)^b}{(p_{ref} - p_0)^b}$$

where  $G_0$  and  $K_0$  are the input values,  $p$  is the current pressure,  $p_0$  the cut-off or datum pressure (must be zero or negative). If  $p$  attempts to fall below  $p_0$  (i.e., more tensile) the shear stresses are set to zero and the pressure is set to  $p_0$ . Thus, the material has no stiffness or strength in tension. The pressure in compression is calculated as follows:

$$p = [-K_0 \ln(V)]^{1/(1-b)}$$

where  $V$  is the relative volume, i.e., the ratio between the original and current volume.

The constants  $a_0, a_1, a_2$  govern the pressure sensitivity of the yield stress. Only the ratios between these values are important - the absolute stress values are taken from the stress-strain curve.

The stress strain pairs define a shear stress versus shear strain curve. The first point on the curve is assumed by default to be (0,0) and does not need to be entered. The slope of the curve must decrease with increasing  $\gamma$ . This curves applies at the reference pressure; at other pressures the curve is scaled by

$$\frac{\tau(p, \gamma)}{\tau(p_{ref}, \gamma)} = \sqrt{\frac{[a_0 + a_1(p - p_0) + a_2(p - p_0)^2]}{[a_0 + a_1(p_{ref} - p_0) + a_2(p_{ref} - p_0)^2]}}$$

The shear stress-strain curve (with points  $(\tau_1, \gamma_1), (\tau_2, \gamma_2) \dots (\tau_N, \gamma_N)$ ) is converted into a series of N elastic perfectly-plastic curves such that  $\sum(\tau_i, \gamma) = \tau(\gamma)$ , as shown in the figure below.

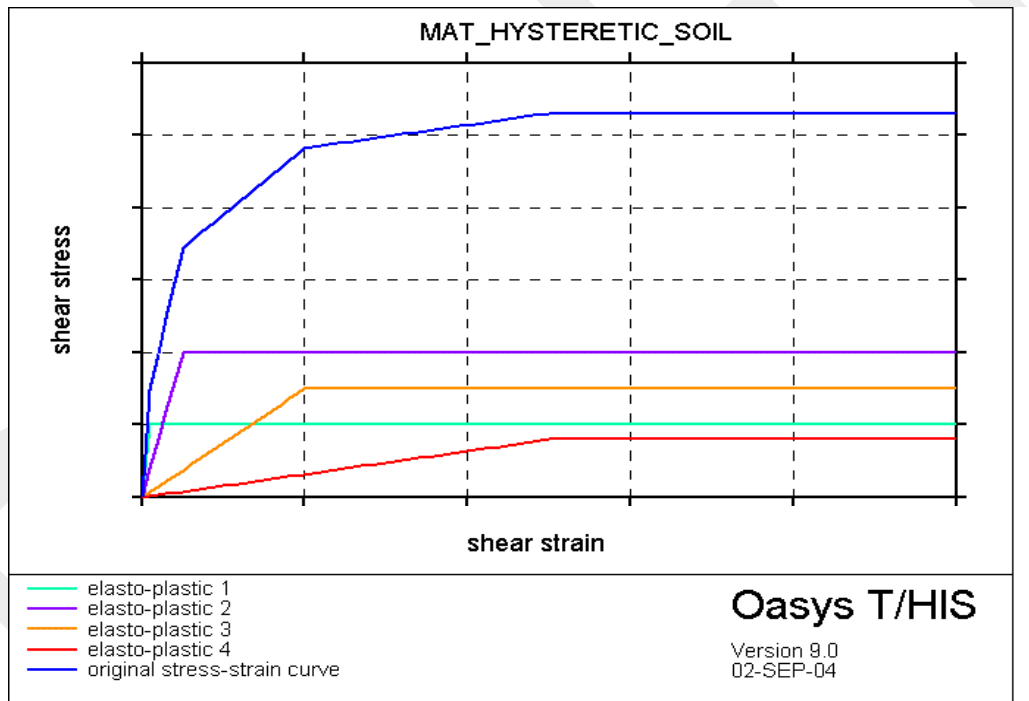

Figure 79.1

Each elastic perfectly-plastic curve represents one “layer” in the material model. Deviatoric stresses are stored and calculated separately for each layer. The yield surface for each layer is defined in terms of stress invariant  $J_2$ ; this is converted internally from the input values of maximum shear stress, assuming a uniaxial stress state:

$$J_{2i} = \left( \sigma'_i : \frac{\sigma'_i}{2} \right) < \frac{4(\tau_{maxi})^2}{3}$$

where subscript i denotes layer i and  $\tau_{\max i}$  is the plastic shear stress of the layer.

In cases where the deviatoric stress state is closer to pure shear, the maximum shear stress reached by the material will be up to  $\sqrt{\frac{4}{3}}$  times higher than the input curve. Users may wish to allow for this by reducing the input curve by this factor. When performing checks on the output, the following relationships may be useful:

Input shear stress is treated by the material model as  $0.5 * Von\ Mises\ Stress = \sqrt{\left(3\sigma'_i : \frac{\sigma'_i}{8}\right)}$

Input shear strain is treated by the material model as  $1.5 * Von\ Mises\ Strain = \sqrt{\left(3\varepsilon'_i : \frac{\varepsilon'_i}{2}\right)}$

The total deviatoric stress is the sum of the deviatoric stresses in each layer. By this method, hysteretic (energy-absorbing) stress-strain curves are generated in response to any strain cycle of amplitude greater than the lowest yield strain of any layer. The example below shows response to small and large strain cycles (blue and pink lines) superposed on the input curve (thick red line).

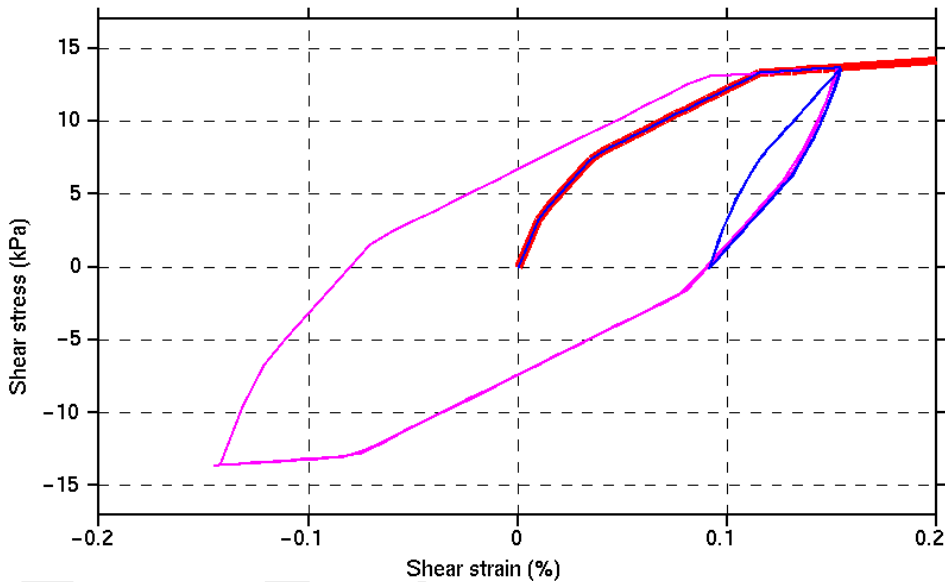

Figure 79.2

**Pressure Sensitivity**

The yield stresses of the layers, and hence the stress at each point on the shear stress-strain input curve, vary with pressure according to constants A0, A1 and A2. The elastic moduli, and hence also the slope of each section of shear stress-strain curve, vary with pressure according to constant B. These effects combine to modify the shear stress-strain curve according to pressure:



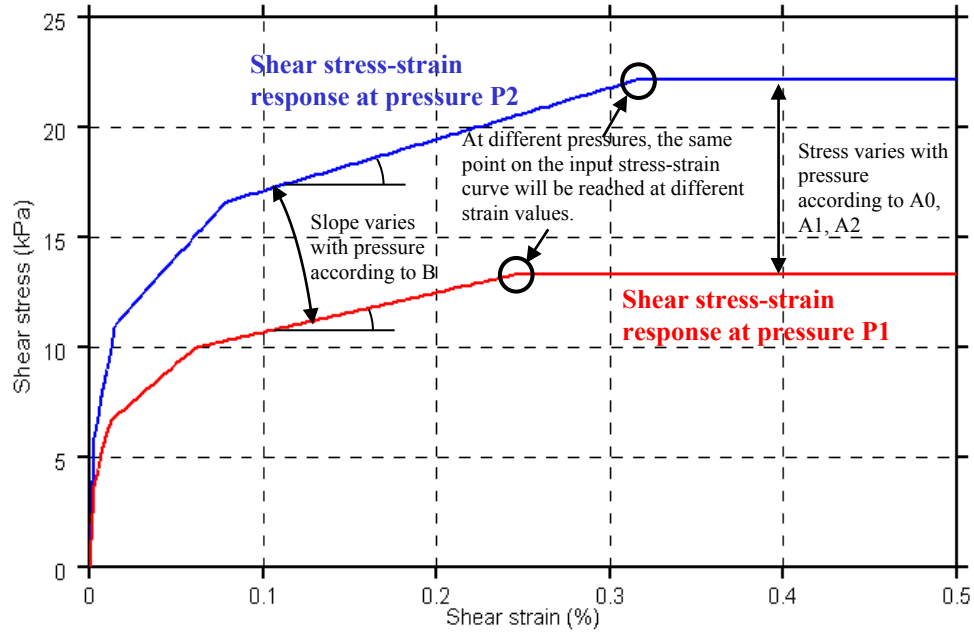

Figure 79.3

Pressure sensitivity can make the solution sensitive to numerical noise. In cases where the expected pressure changes are small compared to the initial stress state, it may be preferable to use pressure from the initial stress state instead of current pressure as the basis for the pressure sensitivity (option PINIT). This causes the bulk modulus and shear stress-strain curve to be calculated once for each element at the start of the analysis and to remain fixed thereafter. PINIT affects both stiffness (calculated using B) and strength (calculated using A0, A1 and A2). If PINIT options 2 (“plane stress” pressure) or 3 (vertical stress) are used, these quantities substitute for pressure  $p$  in the equations above. Input values of  $p_{ref}$  and  $p_0$  should then also be “plane stress” pressure or vertical stress, respectively.

If PINIT is used, B is allowed to be as high as 1.0 (stiffness proportional to initial pressure); otherwise, values of B higher than about 0.5 are not recommended.

**Dilatancy**

Parameters DIL\_A, DIL\_B, DIL\_C and DIL\_D control the compaction and dilatancy that occur in sandy soils as a result of shearing motion. The dilatancy is expressed as a volume strain  $\gamma_v$ :

$$\begin{aligned} \epsilon_v &= \epsilon_r + \epsilon_g \\ \epsilon_r &= DIL\_A(\Gamma)^{DIL\_B} \\ \epsilon_g &= \frac{G^*}{DIL\_C + DIL\_D * G^*} \\ \Gamma &= (\gamma_{xz}^2 + \gamma_{yz}^2)^{1/2} \\ G^* &= \int (d\gamma_{xz}^2 + d\gamma_{yz}^2)^{1/2} \\ \gamma_{xz} > \gamma_{yz} &= 2\epsilon_{xz}, 2\epsilon_{yz} \end{aligned}$$

$\gamma_r$  describes the dilation of the soil due to the magnitude of the shear strains; this is caused by the soil particles having to climb over each other to develop shear strain.

$\gamma_g$  describes compaction of the soil due to collapse of weak areas and voids, caused by continuous shear straining.

Recommended inputs for sandy soil:

DIL\_A 10  
DIL\_B 1.6  
DIL\_C -100  
DIL\_D -2.5

DIL\_A and DIL\_B may cause instabilities in some models. If this facility is used with pore water pressure, liquefaction can be modeled.

\*MAT\_RAMBERG-OSGOOD

This is Material Type 80. This model is intended as a simple model of shear behavior and can be used in seismic analysis.

Card 1            1            2            3            4            5            6            7            8

Variable	MID	RO	GAMY	TAUY	ALPHA	R	BULK	
Type	A8	F	F	F	F	F	F	
Default	none	none	none	none	none	none	none	

<u>VARIABLE</u>	<u>DESCRIPTION</u>
MID	Material identification. A unique number or label not exceeding 8 characters must be specified.
RO	Mass density.
GAMY	Reference shear strain ( $\gamma_y$ )
TAUY	Reference shear stress ( $\tau_y$ )
ALPHA	Stress coefficient ( $\alpha$ )
R	Stress exponent ( $r$ )
BULK	Elastic bulk modulus

**Remarks:**

The Ramberg-Osgood equation is an empirical constitutive relation to represent the one-dimensional elastic-plastic behavior of many materials, including soils. This model allows a simple rate independent representation of the hysteretic energy dissipation observed in soils subjected to cyclic shear deformation. For monotonic loading, the stress-strain relationship is given by:

$$\frac{\gamma}{\gamma_y} = \frac{\tau}{\tau_y} + \alpha \left| \frac{\tau}{\tau_y} \right|^r \quad \text{if } \gamma \geq 0$$

$$\frac{\gamma}{\gamma_y} = \frac{\tau}{\tau_y} - \alpha \left| \frac{\tau}{\tau_y} \right|^r \quad \text{if } \gamma < 0$$

where  $\gamma$  is the shear and  $\tau$  is the stress. The model approaches perfect plasticity as the stress exponent  $r \rightarrow \infty$ . These equations must be augmented to correctly model unloading and reloading material behavior. The first load reversal is detected by  $\gamma\dot{\gamma} < 0$ . After the first reversal, the stress-strain relationship is modified to

$$\frac{(\gamma - \gamma_0)}{2\gamma_y} = \frac{(\tau - \tau_0)}{2\tau_y} + \alpha \left| \frac{(\tau - \tau_0)}{2\tau_y} \right|^r \quad \text{if } \gamma \geq 0$$
$$\frac{(\gamma - \gamma_0)}{2\gamma_y} = \frac{(\tau - \tau_0)}{2\tau_y} - \alpha \left| \frac{(\tau - \tau_0)}{2\tau_y} \right|^r \quad \text{if } \gamma < 0$$

where  $\gamma_0$  and  $\tau_0$  represent the values of strain and stress at the point of load reversal. Subsequent load reversals are detected by  $(\gamma - \gamma_0)\dot{\gamma} < 0$ .

The Ramberg-Osgood equations are inherently one-dimensional and are assumed to apply to shear components. To generalize this theory to the multidimensional case, it is assumed that each component of the deviatoric stress and deviatoric tensorial strain is independently related by the one-dimensional stress-strain equations. A projection is used to map the result back into deviatoric stress space if required. The volumetric behavior is elastic, and, therefore, the pressure  $p$  is found by

$$p = -K\varepsilon_v$$

where  $\varepsilon_v$  is the volumetric strain.

\*MAT\_PLASTICITY\_WITH\_DAMAGE\_{OPTION}

This is Material Types 81 and 82. An elasto-visco-plastic material with an arbitrary stress versus strain curve and arbitrary strain rate dependency can be defined. Damage is considered before rupture occurs. Also, failure based on a plastic strain or a minimum time step size can be defined.

Available options include:

<BLANK>

ORTHO

ORTHO\_RCDC

Including ORTHO invokes an orthotropic damage model, an extension first added as a means of treating failure in aluminum panels. Directional damage begins after a defined failure strain is reached in tension and continues to evolve until a tensile rupture strain is reached in either one of the two orthogonal directions. After rupture is detected at all integration points, the element is deleted. The option ORTHO\_RCDC invokes the damage model developed by Wilkins [Wilkins, et al. 1977]. A nonlocal formulation, which requires additional storage, is used if a characteristic length is defined. The RCDC option, which was added at the request of Toyota, works well in predicting failure in cast aluminum, see Yamasaki, et al., [2006].

Card 1            1            2            3            4            5            6            7            8

Variable	MID	RO	E	PR	SIGY	ETAN	EPPF	TDEL
Type	A8	F	F	F	F	F	F	F
Default	none	none	none	none	none	0.0	10.E+20	10.E+20

Card 2            1            2            3            4            5            6            7            8

Variable	C	P	LCSS	LCSR	EPPFR	VP	LCDM	NUMINT
Type	F	F	F	F	F	F	F	I
Default	0	0	0	0	0	0	0	0

Card 3            1            2            3            4            5            6            7            8

Variable	EPS1	EPS2	EPS3	EPS4	EPS5	EPS6	EPS7	EPS8
Type	F	F	F	F	F	F	F	F
Default	0	0	0	0	0	0	0	0

Card 4            1            2            3            4            5            6            7            8

Variable	ES1	ES2	ES3	ES4	ES5	ES6	ES7	ES8
Type	F	F	F	F	F	F	F	F
Default	0	0	0	0	0	0	0	0

**Read the following card if the option ORTHO\_RCDC is active.**

Card 5            1            2            3            4            5            6            7            8

Variable	ALPHA	BETA	GAMMA	D0	B	LAMBDA	DS	L
Type	F	F	F	F	F	F	F	F
Default	0	0	0	0	0	0	0	0

<u>VARIABLE</u>	<u>DESCRIPTION</u>
MID	Material identification. A unique number or label not exceeding 8 characters must be specified.
RO	Mass density.
E	Young's modulus.
PR	Poisson's ratio.
SIGY	Yield stress.

VARIABLE	DESCRIPTION
ETAN	Tangent modulus, ignored if (LCSS.GT.0) is defined.
EPPF	Plastic strain, $f_s$ , at which material softening begins (logarithmic).
TDEL	Minimum time step size for automatic element deletion.
C	Strain rate parameter, C, see formula below.
P	Strain rate parameter, P, see formula below.
LCSS	Load curve ID or Table ID. Load curve ID defining effective stress versus effective plastic strain. If defined EPS1-EPS8 and ES1-ES8 are ignored. The table ID defines for each strain rate value a load curve ID giving the stress versus effective plastic strain for that rate, See Figure 24.1. The stress versus effective plastic strain curve for the lowest value of strain rate is used if the strain rate falls below the minimum value. Likewise, the stress versus effective plastic strain curve for the highest value of strain rate is used if the strain rate exceeds the maximum value. The strain rate parameters: C and P;
LCSR	Load curve ID defining strain rate scaling effect on yield stress.
EPPFR	Plastic strain at which material ruptures (logarithmic).
VP	Formulation for rate effects: EQ.0.0: Scale yield stress (default), EQ.1.0: Viscoplastic formulation.
LCDM	Load curve ID defining nonlinear damage curve.
NUMINT	Number of through thickness integration points which must fail before the element is deleted. (If zero, all points must fail.) The default of all integration points is not recommended since elements undergoing large strain are often not deleted due to nodal fiber rotations which limit strains at active integration points after most points have failed. Better results are obtained if NUMINT is set to 1 or a number less than one half of the number of through thickness points. For example, if four through thickness points are used, NUMINT should not exceed 2, even for fully integrated shells which have 16 integration points.
EPS1-EPS8	Effective plastic strain values (optional if SIGY is defined). At least 2 points should be defined.
ES1-ES8	Corresponding yield stress values to EPS1 - EPS8.
ALPHA	Parameter $\alpha$ . for the Rc-Dc model

VARIABLE	DESCRIPTION
BETA	Parameter $\beta$ . for the Rc-Dc model
GAMMA	Parameter $\gamma$ . for the Rc-Dc model
D0	Parameter $D_0$ . for the Rc-Dc model
B	Parameter $b$ . for the Rc-Dc model
LAMBDA	Parameter $\lambda$ . for the Rc-Dc model
DS	Parameter $D_s$ . for the Rc-Dc model
L	Optional characteristic element length for this material. We recommend that the default of 0 always be used, especially in parallel runs. If zero, nodal values of the damage function are used to compute the damage gradient. See discussion below.

**Remarks:**

The stress strain behavior may be treated by a bilinear stress strain curve by defining the tangent modulus, ETAN. Alternately, a curve similar to that shown in Figure 10.1 is expected to be defined by (EPS1,ES1) - (EPS8,ES8); however, an effective stress versus effective plastic strain curve (LCSS) may be input instead if eight points are insufficient. The cost is roughly the same for either approach. The most general approach is to use the table definition (LCSS) discussed below.

Three options to account for strain rate effects are possible:

- I. Strain rate may be accounted for using the Cowper and Symonds model which scales the yield stress with the factor

$$1 + \left( \frac{\dot{\epsilon}}{C} \right)^{1/6}$$

where  $\dot{\epsilon}$  is the strain rate,  $\dot{\epsilon} = \sqrt{\dot{\epsilon}_{ij}\dot{\epsilon}_{ij}}$  .

If the viscoplastic option is active, VP=1.0, and if SIGY is > 0 then the dynamic yield stress is computed from the sum of the static stress,  $\sigma_y^s(\epsilon_{eff}^p)$ , which is typically given by a load curve ID, and the initial yield stress, SIGY, multiplied by the Cowper-Symonds rate term as follows:



$$\sigma_y(\varepsilon_{eff}^p, \dot{\varepsilon}_{eff}^p) = \sigma_y^s(\varepsilon_{eff}^p) + SIGY \cdot \left( \frac{\dot{\varepsilon}_{eff}^p}{C} \right)^{1/p}$$

where the plastic strain rate is used. With this latter approach similar results can be obtained between this model and material model: \*MAT\_ANISOTROPIC\_VISCOPLASTIC. If SIGY=0, the following equation is used instead where the static stress,  $\sigma_y^s(\varepsilon_{eff}^p)$ , must be defined by a load curve:

$$\sigma_y(\varepsilon_{eff}^p, \dot{\varepsilon}_{eff}^p) = \sigma_y^s(\varepsilon_{eff}^p) \left[ 1 + \left( \frac{\dot{\varepsilon}_{eff}^p}{C} \right)^{1/p} \right]$$

This latter equation is always used if the viscoplastic option is off.

- II. For complete generality a load curve (LCSR) to scale the yield stress may be input instead. In this curve the scale factor versus strain rate is defined.
- III. If different stress versus strain curves can be provided for various strain rates, the option using the reference to a table (LCSS) can be used. Then the table input in \*DEFINE\_TABLE is expected, see Figure 24.1.

The constitutive properties for the damaged material are obtained from the undamaged material properties. The amount of damage evolved is represented by the constant,  $\omega$ , which varies from zero if no damage has occurred to unity for complete rupture. For uniaxial loading, the nominal stress in the damaged material is given by

$$\sigma_{nominal} = \frac{P}{A}$$

where P is the applied load and A is the surface area. The true stress is given by:

$$\sigma_{true} = \frac{P}{A - A_{loss}}$$

where  $A_{loss}$  is the void area. The damage variable can then be defined:

$$\omega = \frac{A_{loss}}{A} \quad 0 \leq \omega \leq 1$$

In this model damage is defined in terms of plastic strain after the failure strain is exceeded:

$$\omega = \frac{\varepsilon_{eff}^p - \varepsilon_{failure}^p}{\varepsilon_{rupture}^p - \varepsilon_{failure}^p} \quad \text{if} \quad \varepsilon_{failure}^p \leq \varepsilon_{eff}^p \leq \varepsilon_{rupture}^p$$

After exceeding the failure strain softening begins and continues until the rupture strain is reached.

The Rc-Dc model is defined as the following:

The damage D is given by

$$D = \int \omega_1 \omega_2 d\varepsilon^p$$

where  $\varepsilon^p$  is the equivalent plastic strain,

$$\omega_1 = \left( \frac{1}{1 - \gamma \sigma_m} \right)^\alpha$$

is a triaxial stress weighting term and

$$\omega_2 = (2 - A_D)^\beta$$

is a asymmetric strain weighting term. In the above  $\sigma_m$  is the mean stress and

$$A_D = \min \left( \left| \frac{S_2}{S_3} \right|, \left| \frac{S_3}{S_2} \right| \right)$$

Fracture is initiated when the accumulation of damage is

$$\frac{D}{D_c} > 1$$

where  $D_c$  is the a critical damage given by

$$D_c = D_0 \left( 1 + b |\nabla D|^2 \right)$$

A fracture fraction,

$$F = \frac{D - D_c}{D_s}$$

defines the degradations of the material by the Rc-Dc model.

For the Rc-Dc model the gradient of damage needs to be estimated. The damage is connected to the integration points, and, thus, the computation of the gradient requires some manipulation of the LS-DYNA source code. Provided that the damage is connected to nodes, it can be seen as a standard bilinear field and the gradient is easily obtained. To enable this, the damage at the integration points are transferred to the nodes as follows. Let  $E_n$  be the set of elements sharing node  $n$ ,  $|E_n|$  the number of elements in that set,  $P_e$  the set of integration points in element  $e$  and  $|P_e|$  the number of points in that set. The average damage  $\bar{D}_e$  in element  $e$  is computed as

$$\bar{D}_e = \frac{\sum_{p \in P_e} D_p}{|P_e|}$$

where  $D_p$  is the damage in integration point  $p$ . Finally, the damage value in node  $n$  is estimated as

$$D_n = \frac{\sum_{e \in E_n} \bar{D}_e}{|E_n|}.$$

This computation is performed in each time step and requires additional storage. Currently we use three times the total number of nodes in the model for this calculation, but this could be reduced by a considerable factor if necessary. There is an Rc-Dc option for the Gurson dilatational-plastic model. In the implementation of this model, the norm of the gradient is computed differently. Let  $E_f^l$  be the set of elements from within a distance  $l$  of element,  $f$  not including the element itself, and let  $|E_f^l|$  be the number of elements in that set. The norm of the gradient of damage is estimated roughly as

$$\|\nabla D\|_f \approx \frac{1}{|E_f^l|} \sum_{e \in E_f^l} \frac{|D_e - D_f|}{d_{ef}}$$

where  $d_{ef}$  is the distance between element  $f$  and  $e$ .

The reason for taking the first approach is that it should be a better approximation of the gradient, it can for one integration point in each element be seen as a weak gradient of an elementwise constant field. The memory consumption as well as computational work should not be much higher than for the other approach.

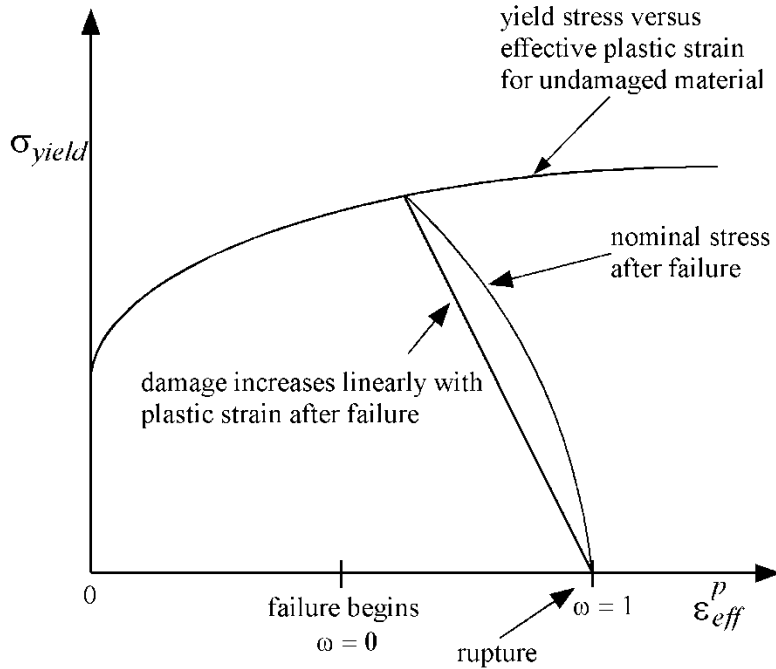

Figure 81-82.1. Stress strain behavior when damage is included.

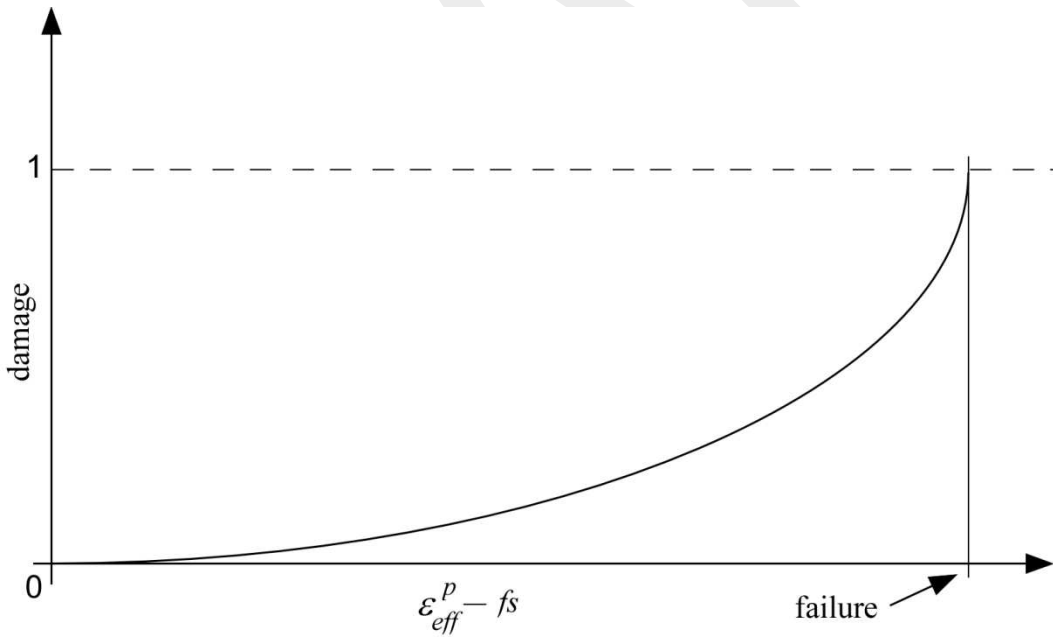

Figure 81-82.2. A nonlinear damage curve is optional. Note that the origin of the curve is at (0,0). It is permissible to input the failure strain,  $f_s$ , as zero for this option. The nonlinear damage curve is useful for controlling the softening behavior after the failure strain is reached.

\*MAT\_FU\_CHANG\_FOAM\_{OPTION}

This is Material Type 83.

An available option includes:

**DAMAGE\_DECAY**

Rate effects can be modeled in low and medium density foams, see Figure 83.1. Hysteretic unloading behavior in this model is a function of the rate sensitivity with the most rate sensitive foams providing the largest hysteresis and vice versa. The unified constitutive equations for foam materials by Chang [1995] provide the basis for this model. The mathematical description given below is excerpted from the reference. Further improvements have been incorporated based on work by Hirth, Du Bois, and Weimar [1998]. Their improvements permit: load curves generated by drop tower test to be directly input, a choice of principal or volumetric strain rates, load curves to be defined in tension, and the volumetric behavior to be specified by a load curve.

The unloading response was generalized by Kolling, Hirth, Erhart and Du Bois [2006] to allow the Mullin's effect to be modeled, i.e., after the first loading and unloading, further reloading occurs on the unloading curve. If it is desired to reload on the loading curves with the new generalized unloading, the DAMAGE decay option is available which allows the reloading to quickly return to the loading curve as the damage parameter decays back to zero in tension and compression.

Card 1            1            2            3            4            5            6            7            8

Variable	MID	RO	E	KCON	TC	FAIL	DAMP	TBID
Type	A8	F	F	F	F	F	F	F
Default	none	none	none	none	1.E+20	none	none	none
Remarks								5

Card 2            1            2            3            4            5            6            7            8

Variable	BVFLAG	SFLAG	RFLAG	TFLAG	PVID	SRAF	REF	HU
Type	F	F	F	F	F	F	F	F
Default	1.0	0.0	0.0	0.0	0.0	0.0	0.0	1.0
Remarks	1	2	3		4			5

**Define two additional cards, cards 3 and 4, if and only if the DAMAGE\_DECAY option is inactive.**

Card 3            1            2            3            4            5            6            7            8

Variable	D0	N0	N1	N2	N3	C0	C1	C2
Type	F	F	F	F	F	F	F	F
Default	0.0	0.0	0.0	0.0	0.0	0.0	0.0	0.0

Card 4            1            2            3            4            5            6            7            8

Variable	C3	C4	C5	AIJ	SIJ	MINR	MAXR	SHAPE
Type	F	F	F	F	F	F	F	F
Default	0.0	0.0	0.0	0.0	0.0	0.0	0.0	0.0

Define one additional card, card 3, if and only if the DAMAGE\_DECAY option is active.

Card 3            1            2            3            4            5            6            7            8

Variable	MINR	MAXR	SHAPE	BETAT	BETAC			
Type	F	F	F	F	F			
Default	0.0	0.0	0.0	0.0	0.0			

<u>VARIABLE</u>	<u>DESCRIPTION</u>
MID	Material identification. A unique number or label not exceeding 8 characters must be specified.
RO	Mass density
E	Young's modulus
KCON	Optional Young's modulus used in the computation of sound speed. This will influence the time step, contact forces, hourglass stabilization forces, and the numerical damping (DAMP). EQ.0.0: KCON is set equal to the max(E, current tangent to stress-strain curve) if TBID.ne.0. If TBID.eq.0, KCON is set equal to the maximum slope of the stress-strain curve.
TC	Tension cut-off stress
FAIL	Failure option after cutoff stress is reached: EQ.0.0: tensile stress remains at cut-off value, EQ.1.0: tensile stress is reset to zero.
DAMP	Viscous coefficient (.05< recommended value <.50) to model damping effects.
TBID	Table ID, see *DEFINE_TABLE, for nominal stress vs. strain data as a function of strain rate. If the table ID is provided, cards 3 and 4 may be left blank and the fit will be done internally. The Table ID can be positive or negative (see remark 5 below).
BVFLAG	Bulk viscosity activation flag, see remark below: EQ.0.0: no bulk viscosity (recommended), EQ.1.0: bulk viscosity active.

<b>VARIABLE</b>	<b>DESCRIPTION</b>
SFLAG	Strain rate flag (see remark 2 below): EQ.0.0: true constant strain rate, EQ.1.0: engineering strain rate.
RFLAG	Strain rate evaluation flag: EQ.0.0: first principal direction, EQ.1.0: principal strain rates for each principal direction, EQ.2.0: volumetric strain rate.
TFLAG	Tensile stress evaluation: EQ.0.0: linear in tension. EQ.1.0: input via load curves with the tensile response corresponds to negative values of stress and strain.
PVID	Optional load curve ID defining pressure versus volumetric strain.
SRAF	Strain rate averaging flag. EQ.0.0: use weighted running average. EQ.1.0: average the last twelve values.
REF	Use reference geometry to initialize the stress tensor. The reference geometry is defined by the keyword: *INITIAL_FOAM_REFERENCE_GEOMETRY (see there for more details). EQ.0.0: off, EQ.1.0: on.
HU	Hysteretic unloading factor between 0 and 1 (default=1, i.e., no energy dissipation), see also Figure 22.57.1.
D0	material constant, see equations below.
N0	material constant, see equations below.
N1	material constant, see equations below.
N2	material constant, see equations below.
N3	material constant, see equations below.
C0	material constant, see equations below.
C1	material constant, see equations below.
C2	material constant, see equations below.
C3	material constant, see equations below.



VARIABLE	DESCRIPTION
C4	material constant, see equations below.
C5	material constant, see equations below.
AIJ,	material constant, see equations below.
SIJ	material constant, see equations below.
MINR	Ratemin, minimum strain rate of interest.
MAXR	Ratemax, maximum strain rate of interest.
SHAPE	Shape factor for unloading. Active for nonzero values of the hysteretic unloading factor HU. Values less than one reduces the energy dissipation and greater than one increases dissipation, see also Figure 57.1.
BETAT	Decay constant for damage in tension. The damage decays after loading in ceases according to $e^{-BETAT \cdot time}$ .
BETAC	Decay constant for damage in compression. The damage decays after loading in ceases according to $e^{-BETAC \cdot time}$ .

### Remarks:

The strain is divided into two parts: a linear part and a non-linear part of the strain

$$E(t) = E^L(t) + E^N(t)$$

and the strain rate become

$$\dot{E}(t) = \dot{E}^L(t) + \dot{E}^N(t)$$

$\dot{E}^N$  is an expression for the past history of  $E^N$ . A postulated constitutive equation may be written as:

$$\sigma(t) = \int_{\tau=0}^{\infty} [E_t^N(\tau), S(t)] d\tau$$

where  $S(t)$  is the state variable and  $\int_{\tau=0}^{\infty}$  is a functional of all values of  $\tau$  in  $T_\tau : 0 \leq \tau \leq \infty$  and

$$E_t^N(\tau) = E^N(t - \tau)$$

where  $\tau$  is the history parameter:

$$E_t^N(\tau = \infty) \Leftrightarrow \text{the virgin material}$$

It is assumed that the material remembers only its immediate past, i.e., a neighborhood about  $\tau = 0$ . Therefore, an expansion of  $E_t^N(\tau)$  in a Taylor series about  $\tau = 0$  yields:

$$E_t^N(\tau) = E^N(0) + \frac{\partial E_t^N}{\partial t}(0)dt$$

Hence, the postulated constitutive equation becomes:

$$\sigma(t) = \sigma^*(E^N(t), \dot{E}^N(t), S(t))$$

where we have replaced  $\frac{\partial E_t^N}{\partial t}$  by  $\dot{E}^N$ , and  $\sigma^*$  is a function of its arguments.

For a special case,

$$\sigma(t) = \sigma^*(E^N(t), S(t))$$

we may write

$$\dot{E}_t^N = f(S(t), s(t))$$

which states that the nonlinear strain rate is the function of stress and a state variable which represents the history of loading. Therefore, the proposed kinetic equation for foam materials is:

$$\dot{E}_t^N = \frac{\sigma}{\|\sigma\|} D_0 \exp \left[ -c_0 \left( \frac{\text{tr}(\sigma S)}{\|\sigma\|^2} \right)^{2n_0} \right]$$

where  $D_0$ ,  $c_0$ , and  $n_0$  are material constants, and  $S$  is the overall state variable. If either  $D_0 = 0$  or  $c_0 \rightarrow \infty$  then the nonlinear strain rate vanishes.

$$\dot{S}_{ij} = \left[ c_1 (a_{ij} R - c_2 S_{ij}) P + c_3 W^{n_1} \left( \|\dot{E}^N\| \right)^{n_2} I_{ij} \right] R$$

$$R = 1 + c_4 \left( \frac{\|\dot{E}^N\|}{c_5} - 1 \right)^{n_3}$$

$$P = \text{tr}(\sigma \dot{E}^N)$$

$$W = \int \text{tr}(\sigma(dE))$$

where  $c_1, c_2, c_3, c_4, c_5, n_1, n_2, n_3,$  and  $a_{ij}$  are material constants and:

$$\|\sigma\| = (\sigma_{ij}\sigma_{ij})^{\frac{1}{2}}$$

$$\|\dot{E}\| = (\dot{E}_{ij}\dot{E}_{ij})^{\frac{1}{2}}$$

$$\|\dot{E}^N\| = (\dot{E}_{ij}^N\dot{E}_{ij}^N)^{\frac{1}{2}}$$

In the implementation by Fu Chang the model was simplified such that the input constants  $a_{ij}$  and the state variables  $S_{ij}$  are scalars.

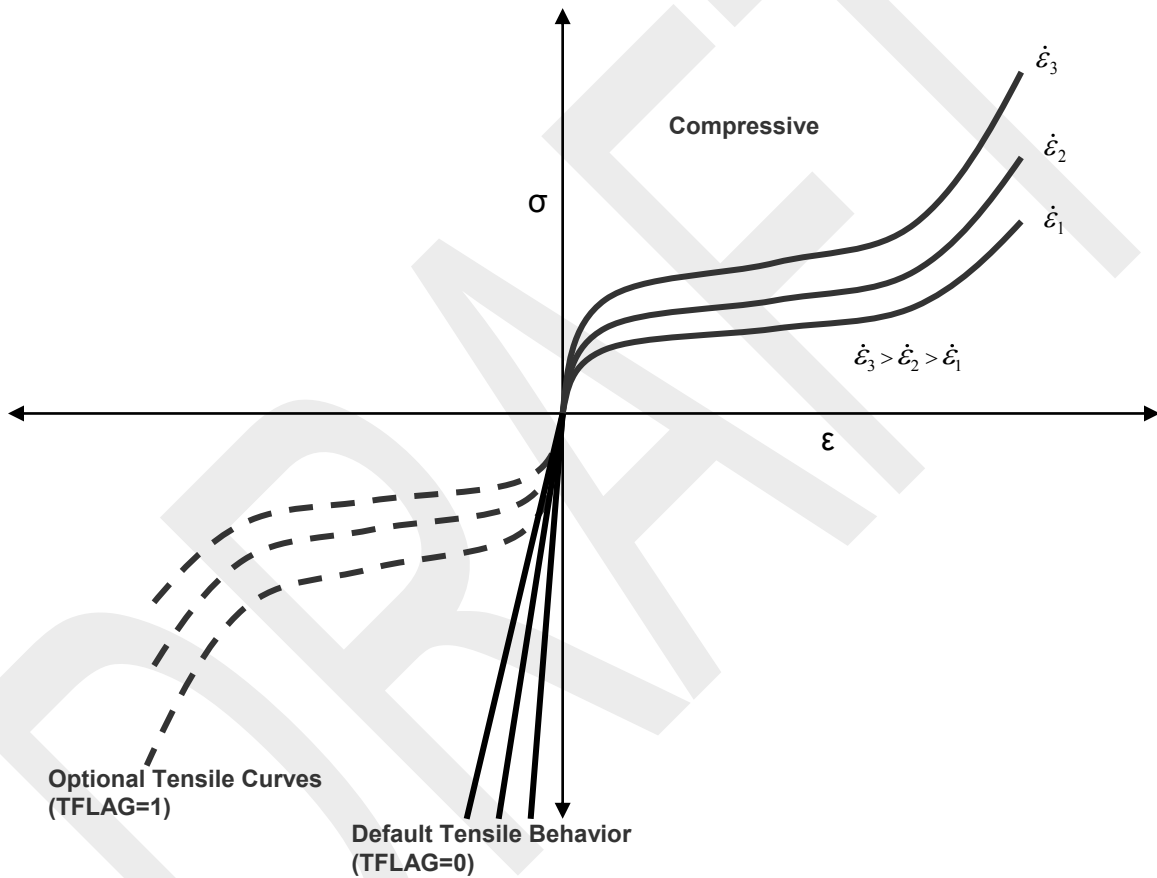

**Figure 83.1.** Nominal stress versus engineering strain curves, which are used to model rate effects in Fu Chang’s foam model.

**Additional Remarks:**

1. The bulk viscosity, which generates a rate dependent pressure, may cause an unexpected volumetric response and consequently, it is optional with this model.
2. Dynamic compression tests at the strain rates of interest in vehicle crash are usually performed with a drop tower. In this test the loading velocity is nearly constant but the true strain rate, which depends on the instantaneous specimen thickness, is not.

Therefore, the engineering strain rate input is optional so that the stress strain curves obtained at constant velocity loading can be used directly.

- 3. To further improve the response under multiaxial loading, the strain rate parameter can either be based on the principal strain rates or the volumetric strain rate.
- 4. Correlation under triaxial loading is achieved by directly inputting the results of hydrostatic testing in addition to the uniaxial data. Without this additional information which is fully optional, triaxial response tends to be underestimated.
- 5. Several options are available to control unloading response in MAT\_083:

1)  $HU=0$  and  $TBID>0$

This is the old way. In this case the unloading response will follow the curve with the lowest strain rate and is rate-independent. The curve with lowest strain rate value (typically zero) in TBID should correspond to the unloading path of the material as measured in a quasistatic test. The quasistatic loading path then corresponds to a realistic (small) value of the strain rate.

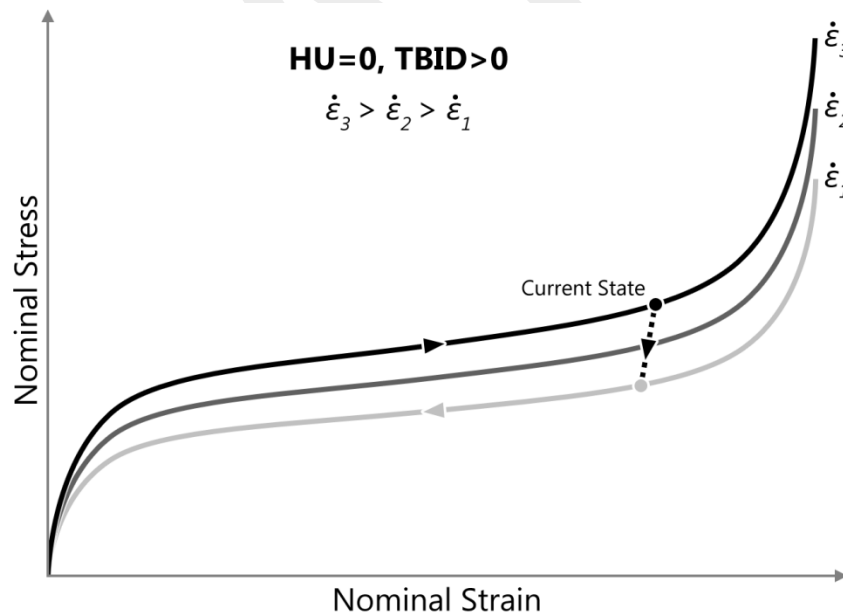

2)  $HU=0$  and  $TBID<0$

In this case the curve with lowest strain rate value (typically zero) in TBID must correspond to the unloading path of the material as measured in a quasistatic test. The quasistatic loading path then corresponds to a realistic (small) value of the strain rate. The quasistatic loading and unloading path (thus the first two curves of the table) should form a closed loop. The unloading response is given by a damage formulation for the principal stresses as follows:

$$\sigma_i = (1-d)\sigma_i$$

The damage parameter  $d$  is computed internally in such a way that the unloading path under uniaxial tension and compression is fitted exactly in the simulation. The unloading response is rate dependent in this case.

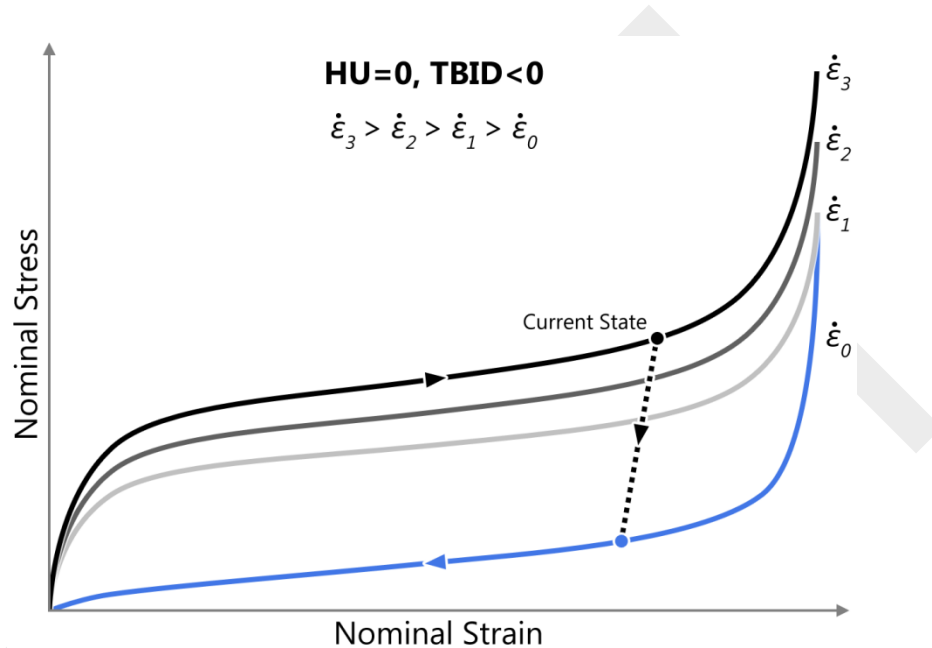

3) HU>0 and TBID>0

No unloading curve should be provided in the table and the curve with the lowest strain rate value in TBID should correspond to the loading path of the material as measured in a quasistatic test. In this case the unloading response is given by a damage formulation for the principal stresses as follows:

$$\sigma_i = (1-d)\sigma_i$$

$$d = (1-HU) \left( 1 - \left( \frac{W_{cur}}{W_{max}} \right)^{SHAPE} \right),$$

where  $W$  corresponds to the current value of the hyperelastic energy per unit undeformed volume. The unloading response is rate dependent in this case.

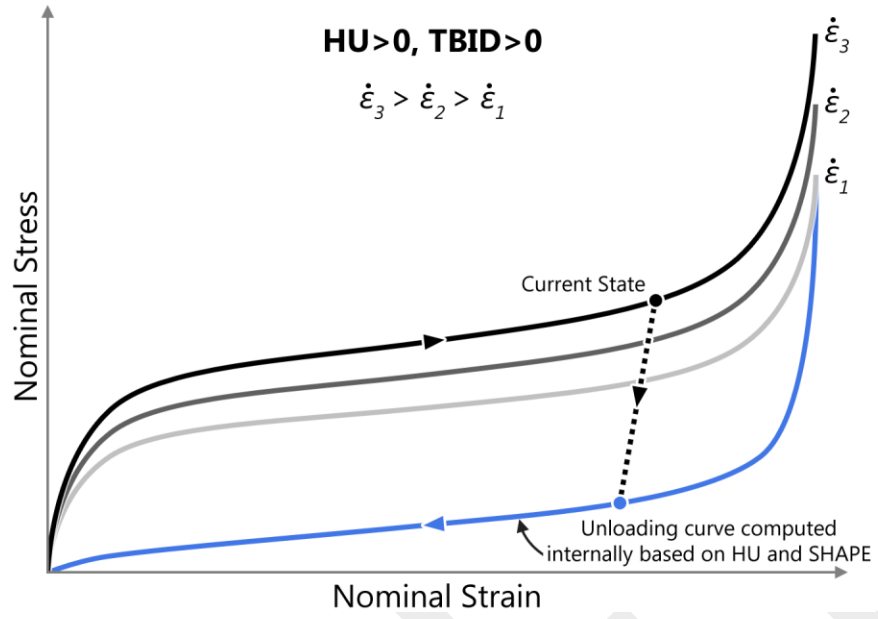

**\*MAT\_WINFRITH\_CONCRETE**

This is Material Type 84 and Material Type 85, only the former of which includes rate effects. The Winfrith concrete model is a smeared crack (sometimes known as pseudo crack), smeared rebar model, implemented in the 8-node single integration point continuum element. This model was developed by Broadhouse and Neilson [1987], and Broadhouse [1995] over many years and has been validated against experiments. The input documentation given here is taken directly from the report by Broadhouse. The Fortran subroutines and quality assurance test problems were also provided to LSTC by the Winfrith Technology Center. The rebar is defined in the section: \*MAT\_WINFRITH\_CONCRETE\_REINFORCEMENT which follows.

Card 1            1            2            3            4            5            6            7            8

Variable	MID	RO	TM	PR	UCS	UTS	FE	ASIZE
Type	A8	F	F	F	F	F	F	F

Card 2            1            2            3            4            5            6            7            8

Variable	E	YS	EH	UELONG	RATE	CONM	CONL	CONT
Type	F	F	F	F	F	F	F	F

Card 3            1            2            3            4            5            6            7            8

Variable	EPS1	EPS2	EPS3	EPS4	EPS5	EPS6	EPS7	EPS8
Type	F	F	F	F	F	F	F	F

Card 4            1            2            3            4            5            6            7            8

Variable	P1	P2	P3	P4	P5	P6	P7	P8
Type	F	F	F	F	F	F	F	F

VARIABLE	DESCRIPTION
MID	Material identification. A unique number or label not exceeding 8 characters must be specified.
RO	Mass density.
TM	Initial tangent modulus of concrete.
PR	Poisson's ratio.
UCS	Uniaxial compressive strength.
UTS	Uniaxial tensile strength.
FE	Depends on value of RATE below. RATE.EQ.0: Fracture energy (energy per unit area dissipated in opening crack). RATE.EQ.1: Crack width at which crack-normal tensile stress goes to zero.
ASIZE	Aggregate size (radius).
E	Young's modulus of rebar.
YS	Yield stress of rebar.
EH	Hardening modulus of rebar
UELONG	Ultimate elongation before rebar fails.
RATE	Rate effects: EQ.0.0: strain rate effects are included (mat 84 – may not conserve energy). EQ.1.0: strain rate effects are turned off (mat 85).
CONM	GT.0: Factor to convert model mass units to kg. EQ.-1.: Mass, length, time units in model are lbf*sec <sup>2</sup> /in, inch, sec. EQ -2.: Mass, length, time units in model are g, cm, microsec. EQ.-3.: Mass, length, time units in model are g, mm, msec. EQ.-4.: Mass, length, time units in model are metric ton, mm, sec. EQ.-5.: Mass, length, time units in model are kg, mm, msec.
CONL	If CONM.GT.0, factor to convert model length units to meters; otherwise CONL is ignored.
CONT	If CONM.GT.0, factor to convert model time units to seconds; otherwise CONT is ignored.



---

<u>VARIABLE</u>	<u>DESCRIPTION</u>
EPS1, EPS2, ...	Volumetric strain values (natural logarithmic values), see Remarks below. A maximum of 8 values are allowed.
P1, P2, ...	Pressures corresponding to volumetric strain values given on Card 3.

**Remarks:**

Pressure is positive in compression; volumetric strain is given by the natural log of the relative volume and is negative in compression. The tabulated data are given in order of increasing compression, with no initial zero point.

If the volume compaction curve is omitted, the following scaled curve is automatically used where  $p_1$  is the pressure at uniaxial compressive failure from:

$$p_1 = \frac{\sigma_c}{3}$$

and  $K$  is the bulk unloading modulus computed from

$$K = \frac{E_s}{3(1-2\nu)}$$

where  $E_s$  is the input tangent modulus for concrete and  $\nu$  is Poisson's ratio.

Volumetric Strain	Pressure
$-p_1/K$	$1.00xp_1$
-0.002	$1.50xp_1$
-0.004	$3.00xp_1$
-0.010	$4.80xp_1$
-0.020	$6.00xp_1$
-0.030	$7.50xp_1$
-0.041	$9.45xp_1$
-0.051	$11.55xp_1$
-0.062	$14.25xp_1$
-0.094	$25.05xp_1$

**Table 84-85.1** Default pressure versus volumetric strain curve for concrete if the curve is not defined.

The Winfrith concrete model generates an additional binary output database containing information on crack locations, directions, and widths. In order to generate the crack database, the LS-DYNA execution line is modified by adding:

**q=crf** where crf is the name of the crack database (e.g., q=DYNCRCK).

LS-PrePost can display the cracks on the deformed mesh plots. To do so, read the d3plot database into LS-PrePost and then select File > Open > Crack from the top menu bar. Or, open the crack database by adding the following to the LS-PrePost execution line:

**q=crf** where crf is the name of the crack database (e.g., q=DYNCRCK).

By default, all the cracks in visible elements are shown. You can eliminate narrow cracks from the display by setting a minimum crack width for displayed cracks. Do this by choosing Setting > Concrete Crack Width. From the top menu bar of LS-PrePost, choosing Misc > Model Info will reveal the number of cracked elements and the maximum crack width in a given plot state.

\*MAT\_WINFRITH\_CONCRETE\_REINFORCEMENT

This is Material Type 84 rebar reinforcement. Reinforcement may be defined in specific groups of elements, but it is usually more convenient to define a two-dimensional mat in a specified layer of a specified material. Reinforcement quantity is defined as the ratio of the cross-sectional area of steel relative to the cross-sectional area of concrete in the element (or layer). These cards may follow either one of two formats below and may also be defined in any order.

**Option 1 (Reinforcement quantities in element groups).**

Card 1            1            2            3            4            5            6            7            8

Variable	EID1	EID2	INC	XR	YR	ZR		
Type	I	I	I	F	F	F		

**Option 2 (Two dimensional layers by part ID).**

Card 1            1            2            3            4            5            6            7            8

Variable		PID	AXIS	COOR	RQA	RQB		
Type	blank	I	I	F	F	F		

<u>VARIABLE</u>	<u>DESCRIPTION</u>
EID1	First element ID in group.
EID2	Last element ID in group
INC	Element increment for generation.
XR	X-reinforcement quantity (for bars running parallel to global x-axis).
YR	Y-reinforcement quantity (for bars running parallel to global y-axis).
ZR	Z-reinforcement quantity (for bars running parallel to global z-axis).
PID	Part ID of reinforced elements.
AXIS	Axis normal to layer. EQ.1: A and B are parallel to global Y and Z, respectively. EQ.2: A and B are parallel to global X and Z, respectively. EQ.3: A and B are parallel to global X and Y, respectively.

<u>VARIABLE</u>	<u>DESCRIPTION</u>
COOR	Coordinate location of layer (X-coordinate if AXIS.EQ.1; Y-coordinate if AXIS.EQ.2; Z-coordinate if AXIS.EQ.3).
RQA	Reinforcement quantity (A).
RQB	Reinforcement quantity (B).

**Remarks:**

1. Reinforcement quantity is the ratio of area of reinforcement in an element to the element's total cross-sectional area in a given direction. This definition is true for both Options 1 and 2. Where the options differ is in the manner in which it is decided which elements are reinforced. In Option 1, the reinforced element IDs are spelled out. In Option 2, elements of part ID PID which are cut by a plane (layer) defined by AXIS and COOR are reinforced.

**\*MAT\_ORTHOTROPIC\_VISCOELASTIC**

This is Material Type 86. It allows the definition of an orthotropic material with a viscoelastic part. This model applies to shell elements.

Card 1            1            2            3            4            5            6            7            8

Variable	MID	RO	EA	EB	EC	VF	K	
Type	A8	F	F	F	F	F	F	

Card 2            1            2            3            4            5            6            7            8

Variable	G0	GINF	BETA	PRBA	PRCA	PRCB		
Type	F	F	F	F	F	F		

Card 3            1            2            3            4            5            6            7            8

Variable	GAB	GBC	GCA	AOPT	MANGLE			
Type	F	F	F	F	F			

Card 4            1            2            3            4            5            6            7            8

Variable				A1	A2	A3		
Type				F	F	F		

Card 5            1            2            3            4            5            6            7            8

Variable	V1	V2	V3	D1	D2	D3		
Type	F	F	F	F	F	F		

<b>VARIABLE</b>	<b>DESCRIPTION</b>
MID	Material identification. A unique number or label not exceeding 8 characters must be specified.
RO	Mass density
EA	Young's Modulus $E_a$
EB	Young's Modulus $E_b$
EC	Young's Modulus $E_c$
VF	Volume fraction of viscoelastic material
K	Elastic bulk modulus
G0	$G_0$ , short-time shear modulus
GINF	$G_\infty$ , long-time shear modulus
BETA	$\beta$ , decay constant
PRBA	Poisson's ratio, $\nu_{ba}$
PRCA	Poisson's ratio, $\nu_{ca}$
PRCB	Poisson's ratio, $\nu_{cb}$
GAB	Shear modulus, $G_{ab}$
GBC	Shear modulus, $G_{bc}$
GCA	Shear modulus, $G_{ca}$

VARIABLE	DESCRIPTION
AOPT	<p>Material axes option (see MAT_OPTION TROPIC_ELASTIC for a more complete description):</p> <p>EQ.0.0: locally orthotropic with material axes determined by element nodes 1, 2, and 4, as with *DEFINE_COORDINATE_NODES, and then rotated about the shell element normal by an angle MANGLE.</p> <p>EQ.2.0: globally orthotropic with material axes determined by vectors defined below, as with *DEFINE_COORDINATE_VECTOR.</p> <p>EQ.3.0: locally orthotropic material axes determined by rotating the material axes about the element normal by an angle, MANGLE, from a line in the plane of the element defined by the cross product of the vector <math>\mathbf{v}</math> with the element normal.</p> <p>LT.0.0: the absolute value of AOPT is a coordinate system ID number (CID on *DEFINE_COORDINATE_NODES, *DEFINE_COORDINATE_SYSTEM or *DEFINE_COORDINATE_VECTOR). Available in R3 version of 971 and later.</p>
MANGLE	<p>Material angle in degrees for AOPT = 0 and 3, may be overridden on the element card, see *ELEMENT_SHELL_BETA.</p>
A1 A2 A3	<p>Define components of vector <math>\mathbf{a}</math> for AOPT = 2.</p>
V1 V2 V3	<p>Define components of vector <math>\mathbf{v}</math> for AOPT = 3.</p>
D1 D2 D3	<p>Define components of vector <math>\mathbf{d}</math> for AOPT = 2.</p>

**Remarks:**

For the orthotropic definition it is referred to Material Type 2 and 21.

**\*MAT\_CELLULAR\_RUBBER**

This is Material Type 87. This material model provides a cellular rubber model with confined air pressure combined with linear viscoelasticity as outlined by Christensen [1980]. See Figure 87.1.

Card 1            1            2            3            4            5            6            7            8

Variable	MID	RO	PR	N				
Type	A8	F	F	I				

**Card 2 if N > 0, a least squares fit is computed from uniaxial data**

Card 2            1            2            3            4            5            6            7            8

Variable	SGL	SW	ST	LCID				
Type	F	F	F	F				

**Card 2 if N = 0, define the following constants**

Card 2            1            2            3            4            5            6            7            8

Variable	C10	C01	C11	C20	C02			
Type	F	F	F	F	F			

Card 3            1            2            3            4            5            6            7            8

Variable	P0	PHI	IVS	G	BETA			
Type	F	F	F	F	F			

<u>VARIABLE</u>	<u>DESCRIPTION</u>
MID	Material identification. A unique number or label not exceeding 8 characters must be specified.



VARIABLE	DESCRIPTION
RO	Mass density
PR	Poisson's ratio, typical values are between .0 to .2. Due to the large compressibility of air, large values of Poisson's ratio generates physically meaningless results.
N	Order of fit (currently < 3). If $n > 0$ then a least square fit is computed with uniaxial data. The parameters given on card 2 should be specified. Also see *MAT_MOONEY_RIVLIN_RUBBER (material model 27). A Poisson's ratio of .5 is assumed for the void free rubber during the fit. The Poisson's ratio defined on Card 1 is for the cellular rubber. A void fraction formulation is used.

**Define, if N > 0:**

SGL	Specimen gauge length $l_0$
SW	Specimen width
ST	Specimen thickness
LCID	Load curve ID giving the force versus actual change $\Delta L$ in the gauge length.

**Define, if N = 0:**

C10	Coefficient, $C_{10}$
C01	Coefficient, $C_{01}$
C11	Coefficient, $C_{11}$
C20	Coefficient, $C_{20}$
C02	Coefficient, $C_{02}$
P0	Initial air pressure, $P_0$
PHI	Ratio of cellular rubber to rubber density, $\Phi$
IVS	Initial volumetric strain, $\gamma_0$
G	Optional shear relaxation modulus, $G$ , for rate effects (viscosity)
BETA	Optional decay constant, $\beta_1$

**Remarks:**

Rubber is generally considered to be fully incompressible since the bulk modulus greatly exceeds the shear modulus in magnitude. To model the rubber as an unconstrained material a hydrostatic work term,  $W_H(J)$ , is included in the strain energy functional which is function of the relative volume,  $J$ , [Ogden 1984]:

$$W(J_1, J_2, J) = \sum_{p,q=0}^n C_{pq} (J_1 - 3)^p (J_2 - 3)^q + W_H(J)$$

$$J_1 + I_1 I_3^{-1/3}$$

$$J_2 + I_2 I_3^{-2/3}$$

In order to prevent volumetric work from contributing to the hydrostatic work the first and second invariants are modified as shown. This procedure is described in more detail by Sussman and Bathe [1987].

The effects of confined air pressure in its overall response characteristics is included by augmenting the stress state within the element by the air pressure.

$$\sigma_{ij} = \sigma_{ij}^{sk} - \delta_{ij} \sigma^{air}$$

where  $\sigma_{ij}^{sk}$  is the bulk skeletal stress and  $\sigma^{air}$  is the air pressure computed from the equation:

$$\sigma^{air} = -\frac{p_0 \gamma}{1 + \gamma - \phi}$$

where  $p_0$  is the initial foam pressure usually taken as the atmospheric pressure and  $\gamma$  defines the volumetric strain

$$\gamma = V - 1 + \gamma_0$$

where  $V$  is the relative volume of the voids and  $\gamma_0$  is the initial volumetric strain which is typically zero. The rubber skeletal material is assumed to be incompressible.

Rate effects are taken into account through linear viscoelasticity by a convolution integral of the form:

$$\sigma_{ij} = \int_0^t g_{ijkl}(t - \tau) \frac{\partial \epsilon_{kl}}{\partial \tau} d\tau$$

or in terms of the second Piola-Kirchhoff stress,  $S_{ij}$ , and Green's strain tensor,  $E_{ij}$ ,

$$S_{ij} = \int_0^t G_{ijkl}(t - \tau) \frac{\partial \epsilon_{kl}}{\partial \tau} d\tau$$

where  $g_{ijkl}(t-\tau)$  and  $G_{ijkl}(t-\tau)$  are the relaxation functions for the different stress measures. This stress is added to the stress tensor determined from the strain energy functional.

Since we wish to include only simple rate effects, the relaxation function is represented by one term from the Prony series:

$$g(t) = \alpha_0 + \sum_{m=1}^N \alpha_m e^{-\beta t}$$

given by,

$$g(t) = E_d e^{-\beta t}$$

This model is effectively a Maxwell fluid which consists of a damper and spring in series. We characterize this in the input by a shear modulus,  $G$ , and decay constant,  $\beta_1$ .

The Mooney-Rivlin rubber model (model 27) is obtained by specifying  $n=1$  without air pressure and viscosity. In spite of the differences in formulations with Model 27, we find that the results obtained with this model are nearly identical with those of material type 27 as long as large values of Poisson's ratio are used.

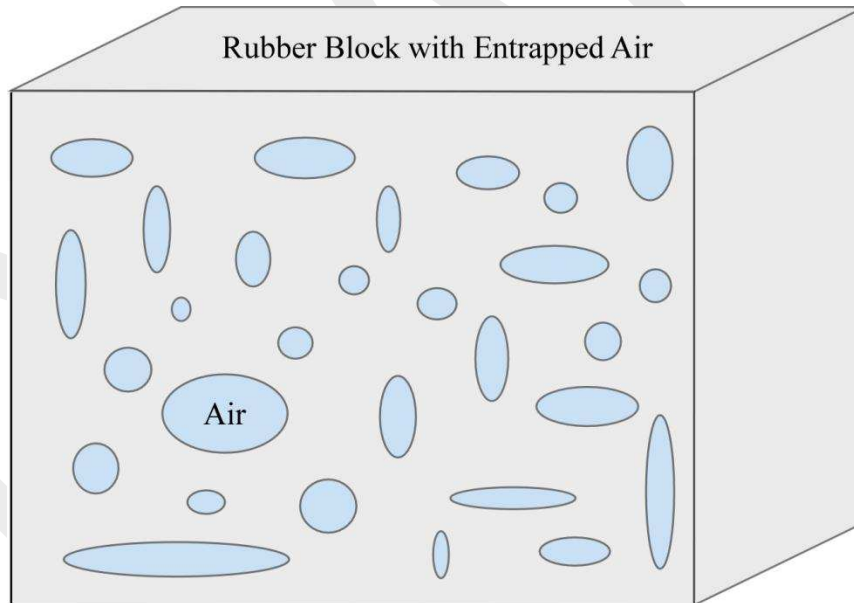

**Figure 87.1.** Cellular rubber with entrapped air. By setting the initial air pressure to zero, an open cell, cellular rubber can be simulated.

**\*MAT\_MTS**

This is Material Type 88. The MTS model is due to Mauldin, Davidson, and Henninger [1990] and is available for applications involving large strains, high pressures and strain rates. As described in the foregoing reference, this model is based on dislocation mechanics and provides a better understanding of the plastic deformation process for ductile materials by using an internal state variable call the mechanical threshold stress. This kinematic quantity tracks the evolution of the material's microstructure along some arbitrary strain, strain rate, and temperature-dependent path using a differential form that balances dislocation generation and recovery processes. Given a value for the mechanical threshold stress, the flow stress is determined using either a thermal-activation-controlled or a drag-controlled kinetics relationship. An equation-of-state is required for solid elements and a bulk modulus must be defined below for shell elements.

Card 1            1            2            3            4            5            6            7            8

Variable	MID	RO	SIGA	SIGI	SIGS	SIG0	BULK	
Type	A8	F	F	F	F	F	F	

Card 2            1            2            3            4            5            6            7            8

Variable	HF0	HF1	HF2	SIGS0	EDOTS0	BURG	CAPA	BOLTZ
Type	F	F	F	F	F	F	F	F

Card 3            1            2            3            4            5            6            7            8

Variable	SM0	SM1	SM2	EDOT0	GO	PINV	QINV	EDOTI
Type	F	F	F	F	F	F	F	F

Card 4            1            2            3            4            5            6            7            8

Variable	G0I	PINVI	QINVI	EDOTS	G0S	PINVS	QINVS	
Type	F	F	F	F	F	F	F	

Card 5            1            2            3            4            5            6            7            8

Variable	RHOCPR	TEMPRF	ALPHA	EPS0				
Type	F	F						

**VARIABLE****DESCRIPTION**

MID	Material identification. A unique number or label not exceeding 8 characters must be specified.
RO	Mass density
SIGA	$\hat{\sigma}_a$ , dislocation interactions with long-range barriers (force/area).
SIGI	$\hat{\sigma}_i$ , dislocation interactions with interstitial atoms (force/area).
SIGS	$\hat{\sigma}_s$ , dislocation interactions with solute atoms (force/area).
SIG0	$\hat{\sigma}_0$ , initial value of $\hat{\sigma}$ at zero plastic strain (force/area) NOT USED.
HF0	$a_0$ , dislocation generation material constant (force/area).
HF1	$a_1$ , dislocation generation material constant (force/area).
HF2	$a_2$ , dislocation generation material constant (force/area).
SIGS0	$\hat{\sigma}_{\varepsilon_{s0}}$ , saturation threshold stress at 0° K (force/area).
BULK	Bulk modulus defined for shell elements only. Do not input for solid elements.
EDOTS0	$\dot{\varepsilon}_{\varepsilon_{s0}}$ , reference strain-rate (time <sup>-1</sup> ).

VARIABLE	DESCRIPTION
BURG	Magnitude of Burgers vector (interatomic slip distance), (distance)
CAPA	Material constant, A.
BOLTZ	Boltzmann's constant, k (energy/degree).
SM0	$G_0$ , shear modulus at zero degrees Kelvin (force/area).
SM1	$b_1$ , shear modulus constant (force/area).
SM2	$b_2$ , shear modulus constant (degree).
EDOT0	$\dot{\epsilon}_o$ , reference strain-rate ( $\text{time}^{-1}$ ).
G0	$g_0$ , normalized activation energy for a dislocation/dislocation interaction.
PINV	$\frac{1}{p}$ , material constant.
QINV	$\frac{1}{q}$ , material constant.
EDOTI	$\dot{\epsilon}_{o,i}$ , reference strain-rate ( $\text{time}^{-1}$ ).
G0I	$g_{0,i}$ , normalized activation energy for a dislocation/interstitial interaction.
PINVI	$\frac{1}{p_i}$ , material constant.
QINVI	$\frac{1}{q_i}$ , material constant.
EDOTS	$\dot{\epsilon}_{o,s}$ , reference strain-rate ( $\text{time}^{-1}$ ).
G0S	$g_{0,s}$ normalized activation energy for a dislocation/solute interaction.
PINVS	$\frac{1}{p_s}$ , material constant.

VARIABLE	DESCRIPTION
QINVS	$\frac{1}{q_s}$ , material constant.
RHOCPR	$\rho c_p$ , product of density and specific heat.
TEMPRF	$T_{ref}$ , initial element temperature in degrees K.
ALPHA	$\alpha$ , material constant (typical value is between 0 and 2).
EPS0	$\varepsilon_0$ , factor to normalize strain rate in the calculation of $\Theta_o$ . (time <sup>-1</sup> ).

### Remarks:

The flow stress  $\sigma$  is given by:

$$\sigma = \hat{\sigma}_a + \frac{G}{G_0} \left[ s_{th} \hat{\sigma} + s_{th,i} \hat{\sigma}_i + s_{th,s} \hat{\sigma}_s \right]$$

The first product in the equation for  $\tau$  contains a micro-structure evolution variable, i.e.,  $\hat{\sigma}$ , called the *Mechanical Threshold Stress* (MTS), that is multiplied by a constant-structure deformation variable  $s_{th}$ :  $s_{th}$  is a function of absolute temperature T and the plastic strain-rates  $\dot{\varepsilon}^p$ . The evolution equation for  $\hat{\sigma}$  is a differential hardening law representing dislocation-dislocation interactions:

$$\frac{\partial \hat{\sigma}}{\partial \varepsilon^p} \equiv \Theta_o \left[ 1 - \frac{\tanh\left(\alpha \frac{\hat{\sigma}}{\hat{\sigma}_{es}}\right)}{\tanh(\alpha)} \right]$$

The term,  $\frac{\partial \hat{\sigma}}{\partial \varepsilon^p}$ , represents the hardening due to dislocation generation and the stress ratio,  $\frac{\hat{\sigma}}{\hat{\sigma}_{es}}$ , represents softening due to dislocation recovery. The threshold stress at zero strain-hardening  $\hat{\sigma}_{es}$  is called the saturation threshold stress. Relationships for  $\Theta_o$ ,  $\hat{\sigma}_{es}$  are:

$$\Theta_o = a_o + a_1 \ln\left(\frac{\dot{\varepsilon}^p}{\varepsilon_0}\right) + a_2 \sqrt{\frac{\dot{\varepsilon}^p}{\varepsilon_0}}$$

which contains the material constants,  $a_o$ ,  $a_1$ , and  $a_2$ . The constant,  $\hat{\sigma}_{es}$ , is given as:

$$\hat{\sigma}_{\epsilon s} = \hat{\sigma}_{\epsilon s0} \left( \frac{\dot{\epsilon}^p}{\dot{\epsilon}_{\epsilon s0}} \right)^{kT/Gb^3A}$$

which contains the input constants:  $\hat{\sigma}_{\epsilon s0}$ ,  $\dot{\epsilon}_{\epsilon s0}$ ,  $b$ ,  $A$ , and  $k$ . The shear modulus  $G$  appearing in these equations is assumed to be a function of temperature and is given by the correlation.

$$G = G_0 - b_1 / (e^{b_2/T} - 1)$$

which contains the constants:  $G_0$ ,  $b_1$ , and  $b_2$ . For thermal-activation controlled deformation  $s_{th}$  is evaluated via an Arrhenius rate equation of the form:

$$s_{th} = \left[ 1 - \left( \frac{kT \ln \left( \frac{\dot{\epsilon}_0}{\dot{\epsilon}^p} \right)^{\frac{1}{q}}}{Gb^3 g_0} \right)^{\frac{1}{p}} \right]$$

The absolute temperature is given as:

$$T = T_{ref} + \frac{E}{\rho c_p}$$

where  $E$  is the internal energy density per unit initial volume.



\*MAT\_PLASTICITY\_POLYMER

This is Material Type 89. An elasto-plastic material with an arbitrary stress versus strain curve and arbitrary strain rate dependency can be defined. It is intended for applications where the elastic and plastic sections of the response are not as clearly distinguishable as they are for metals. Rate dependency of failure strain is included. Many polymers show a more brittle response at high rates of strain.

Card 1            1            2            3            4            5            6            7            8

Variable	MID	RO	E	PR				
Type	A8	F	F	F				
Default	none	none	none	none				

Card 2            1            2            3            4            5            6            7            8

Variable	C	P	LCSS	LCSR				
Type	F	F	F	F				
Default	0	0	0	0				

Card 3            1            2            3            4            5            6            7            8

Variable	EFTX	DAMP	RATEFAC	LCFAIL				
Type	F	F	F	F				
Default	0	0	0	0				

VARIABLE

DESCRIPTION

MID

Material identification. A unique number or label not exceeding 8 characters must be specified.

<u>VARIABLE</u>	<u>DESCRIPTION</u>
RO	Mass density.
E	Young's modulus.
PR	Poisson's ratio.
C	Strain rate parameter, C, (Cowper Symonds).
P	Strain rate parameter, P, (Cowper Symonds).
LCSS	Load curve ID or Table ID. Load curve ID defining effective stress versus total effective strain. The table ID defines for each strain rate value a load curve ID giving the stress versus total effective strain for that rate.
LCSR	Load curve ID defining strain rate scaling effect on yield stress. If LCSR is negative, the load curve is evaluated using a binary search for the correct interval for the strain rate. The binary search is slower than the default incremental search, but in cases where large changes in the strain rate may occur over a single time step, it is more robust.
EFTX	Failure flag. EQ.0.0: failure determined by maximum tensile strain (default), EQ.1.0: failure determined only by tensile strain in local x direction, EQ.2.0: failure determined only by tensile strain in local y direction.
DAMP	Stiffness-proportional damping ratio. Typical values are 1e-3 or 1e-4. If set too high instabilities can result.
RATEFAC	Filtering factor for strain rate effects. Must be between 0 (no filtering) and 1 (infinite filtering). The filter is a simple low pass filter to remove high frequency oscillation from the strain rates before they are used in rate effect calculations. The cut off frequency of the filter is $[(1 - RATEFAC) / timestep]$ rad/sec.
LCFAIL	Load curve ID giving variation of failure strain with strain rate. The points on the x-axis should be natural log of strain rate, the y-axis should be the true strain to failure. Typically this is measured by uniaxial tensile test, and the strain values converted to true strain.

**Remarks:**

1. Unlike other LS-DYNA material models, both the input stress-strain curve and the strain to failure are defined as total true strain, not plastic strain. The input can be defined from uniaxial tensile tests; nominal stress and nominal strain from the tests must be converted to true stress and true strain. The elastic component of strain must not be subtracted out.

2. The stress-strain curve is permitted to have sections steeper (i.e. stiffer) than the elastic modulus. When these are encountered the elastic modulus is increased to prevent spurious energy generation.
3. Sixty-four bit precision is recommended when using this material model, especially if the strains become high.
4. Invariant shell numbering is recommended when using this material model. See \*CONTROL\_ACCURACY.
5. Damage in the material begins when the “failure strain” is reached, i.e., when extra history variable 8 reaches a value of 1.0. The element is then progressively softened via a damage model until history variable 8 reaches a value of 1.1 at which point the element is deleted. In other words, the element is deleted at 1.1 times the failure strain.

**\*MAT\_ACOUSTIC**

This is Material Type 90. This model is appropriate for tracking low pressure stress waves in an acoustic media such as air or water and can be used only with the acoustic pressure element formulation. The acoustic pressure element requires only one unknown per node. This element is very cost effective. Optionally, cavitation can be allowed.

Card 1            1            2            3            4            5            6            7            8

Variable	MID	RO	C	BETA	CF	ATMOS	GRAV	
Type	A8	F	F	F	F	F	F	

Card 2            1            2            3            4            5            6            7            8

Variable	XP	YP	ZP	XN	YN	ZN		
Type	F	F	F	F	F	F		

<u>VARIABLE</u>	<u>DESCRIPTION</u>
MID	Material identification. A unique number or label not exceeding 8 characters must be specified.
RO	Mass density
C	Sound speed
BETA	Damping factor. Recommend values are between 0.1 and 1.0.
CF	Cavitation flag: EQ.0.0: off, EQ.1.0: on.
ATMOS	Atmospheric pressure (optional)
GRAV	Gravitational acceleration constant (optional)
XP	x-coordinate of free surface point
YP	y-coordinate of free surface point
ZP	z-coordinate of free surface point

---

<u>VARIABLE</u>	<u>DESCRIPTION</u>
XN	x-direction cosine of free surface normal vector
YN	y-direction cosine of free surface normal vector
ZN	z-direction cosine of free surface normal vector



**\*MAT\_SOFT\_TISSUE\_{OPTION}**

Available options include:

**<BLANK>**

**VISCO**

This is Material Type 91 (*OPTION*=<BLANK>) or Material Type 92 (*OPTION*=VISCO). This material is a transversely isotropic hyperelastic model for representing biological soft tissues such as ligaments, tendons, and fascia. The representation provides an isotropic Mooney-Rivlin matrix reinforced by fibers having a strain energy contribution with the qualitative material behavior of collagen. The model has a viscoelasticity option which activates a six-term Prony series kernel for the relaxation function. In this case, the hyperelastic strain energy represents the elastic (long-time) response. See Weiss et al. [1996] and Puso and Weiss [1998] for additional details. The material is available for use with brick and shell elements. When used with shell elements, the Belytschko-Tsay formulation (#2) must be selected.

Card 1            1            2            3            4            5            6            7            8

Variable	MID	RO	C1	C2	C3	C4	C5	
Type	A8	F	F	F	F	F	F	

Card 2            1            2            3            4            5            6            7            8

Variable	XK	XLAM	FANG	XLAM0	FAILSF	FAILSM	FAILSHR	
Type	F	F	F	F	F	F	F	

Card 3            1            2            3            4            5            6            7            8

Variable	AOPT	AX	AY	AZ	BX	BY	BZ	
Type	F	F	F	F	F	F	F	

Card 4            1            2            3            4            5            6            7            8

Variable	LA1	LA2	LA3	MACF				
Type	F	F	F	I				

**Define the following two cards only for the VISCO option:**

Card 5            1            2            3            4            5            6            7            8

Variable	S1	S2	S3	S4	S5	S6		
Type	F	F	F	F	F	F		

Card 6            1            2            3            4            5            6            7            8

Variable	T1	T2	T3	T4	T5	T6		
Type	F	F	F	F	F	F		

**VARIABLE**

**DESCRIPTION**

- MID            Material identification. A unique number or label not exceeding 8 characters must be specified.
- RO            Mass density
- C1 - C5        Hyperelastic coefficients (see equations below)
- XK            Bulk Modulus
- XLAM         Stretch ratio at which fibers are straightened
- FANG         Fiber angle in local shell coordinate system (shells only)
- XLAM0        Initial fiber stretch (optional)
- FAILSF        Stretch ratio for ligament fibers at failure (applies to shell elements only). If zero, failure is not considered.

<b>VARIABLE</b>	<b>DESCRIPTION</b>
FAILSM	Stretch ratio for surrounding matrix material at failure (applies to shell elements only). If zero, failure is not considered.
FAILSHR	Shear strain at failure at a material point (applies to shell elements only). If zero, failure is not considered. This failure value is independent of FAILSF and FAILSM.
AOPT	Material axes option, see Figure 2.1 (bricks only): EQ.0.0: locally orthotropic with material axes determined by element nodes as shown in Figure 2.1. Nodes 1, 2, and 4 of an element are identical to the nodes used for the definition of a coordinate system as by *DEFINE_COORDINATE_NODES. EQ.1.0: locally orthotropic with material axes determined by a point in space and the global location of the element center; this is the a-direction. This option is for solid elements only. EQ.2.0: globally orthotropic with material axes determined by vectors defined below, as with *DEFINE_COORDINATE_VECTOR. EQ.3.0: locally orthotropic material axes determined by a line in the plane of the element defined by the cross product of the vector $\mathbf{v}$ with the element normal. The plane of a solid element is the midsurface between the inner surface and outer surface defined by the first four nodes and the last four nodes of the connectivity of the element, respectively. EQ.4.0: locally orthotropic in cylindrical coordinate system with the material axes determined by a vector $\mathbf{v}$ , and an originating point, P, which define the centerline axis. This option is for solid elements only. LT.0.0: the absolute value of AOPT is a coordinate system ID number (CID on *DEFINE_COORDINATE_NODES, *DEFINE_COORDINATE_SYSTEM or *DEFINE_COORDINATE_VECTOR). Available in R3 version of 971 and later.
AX, AY, AZ	Equal to XP,YP,ZP for AOPT=1, Equal to A1,A2,A3 for AOPT=2, Equal to V1,V2,V3 for AOPT=3 or 4.
BX, BY, BZ	Equal to D1,D2,D3 for AOPT=2 Equal to XP,YP,ZP for AOPT=4
LAX, LAY, LAZ	Local fiber orientation vector (bricks only)



VARIABLE	DESCRIPTION
MACF	Material axes change flag for brick elements: EQ.1: No change, default, EQ.2: switch material axes a and b, EQ.3: switch material axes a and c, EQ.4: switch material axes b and c.
T1 - T6	Characteristic times for Prony series relaxation kernel ( <i>OPTION=VISCO</i> )

### Remarks:

The overall strain energy  $W$  is "uncoupled" and includes two isotropic deviatoric matrix terms, a fiber term  $F$ , and a bulk term:

$$W = C_1 \left( \tilde{I}_1 - 3 \right) + C_2 \left( \tilde{I}_2 - 3 \right) + F(\lambda) + \frac{1}{2} K \left[ \ln(J) \right]^2$$

Here,  $\tilde{I}_1$  and  $\tilde{I}_2$  are the deviatoric invariants of the right Cauchy deformation tensor,  $\lambda$  is the deviatoric part of the stretch along the current fiber direction, and  $J = \det \mathbf{F}$  is the volume ratio. The material coefficients  $C_1$  and  $C_2$  are the Mooney-Rivlin coefficients, while  $K$  is the effective bulk modulus of the material (input parameter *XX*).

The derivatives of the fiber term  $F$  are defined to capture the behavior of crimped collagen. The fibers are assumed to be unable to resist compressive loading - thus the model is isotropic when  $\lambda < 1$ . An exponential function describes the straightening of the fibers, while a linear function describes the behavior of the fibers once they are straightened past a critical fiber stretch level  $\lambda \geq \lambda^*$  (input parameter *XLAM*):

$$\frac{\partial F}{\partial \lambda} = \left\{ \begin{array}{ll} 0 & \lambda < 1 \\ \frac{C_3}{\lambda} \left[ \exp(C_4(\lambda - 1)) - 1 \right] & \lambda < \lambda^* \\ \frac{1}{\lambda} (C_5 \lambda + C_6) & \lambda \geq \lambda^* \end{array} \right\}$$

Coefficients  $C_3$ ,  $C_4$ , and  $C_5$  must be defined by the user.  $C_6$  is determined by LS-DYNA to ensure stress continuity at  $\lambda = \lambda^*$ . Sample values for the material coefficients  $C_1 - C_5$  and  $\lambda^*$  for ligament tissue can be found in Quapp and Weiss [1998]. The bulk modulus  $K$  should be at least 3 orders of magnitude larger than  $C_1$  to ensure near-incompressible material behavior.

Viscoelasticity is included via a convolution integral representation for the time-dependent second Piola-Kirchhoff stress  $\mathbf{S}(\mathbf{C}, t)$ :

$$\mathbf{S}(\mathbf{C}, t) = \mathbf{S}^e(\mathbf{C}) + \int_0^t 2G(t-s) \frac{\partial W}{\partial \mathbf{C}(s)} ds$$

Here,  $\mathbf{S}^e$  is the elastic part of the second PK stress as derived from the strain energy, and  $G(t-s)$  is the reduced relaxation function, represented by a Prony series:

$$G(t) = \sum_{i=1}^6 S_i \exp\left(-\frac{t}{T_i}\right)$$

Puso and Weiss [1998] describe a graphical method to fit the Prony series coefficients to relaxation data that approximates the behavior of the continuous relaxation function proposed by Y-C. Fung, as quasilinear viscoelasticity.

### **Remarks on Input Parameters:**

Cards 1 through 4 must be included for both shell and brick elements, although for shells cards 3 and 4 are ignored and may be blank lines.

For shell elements, the fiber direction lies in the plane of the element. The local axis is defined by a vector between nodes n1 and n2, and the fiber direction may be offset from this axis by an angle FANG.

For brick elements, the local coordinate system is defined using the convention described previously for \*MAT\_ORTHOTROPIC\_ELASTIC. The fiber direction is oriented in the local system using input parameters LAX, LAY, and LAZ. By default, (LAX,LAY,LAZ) = (1,0,0) and the fiber is aligned with the local x-direction.

An optional initial fiber stretch can be specified using XLAM0. The initial stretch is applied during the first time step. This creates preload in the model as soft tissue contacts and equilibrium is established. For example, a ligament tissue "uncrimping strain" of 3% can be represented with initial stretch value of 1.03.

If the **VISCO** option is selected, at least one Prony series term (S1,T1) must be defined.

**\*MAT\_ELASTIC\_6DOF\_SPRING\_DISCRETE\_BEAM**

This is Material Type 93. This material model is defined for simulating the effects of nonlinear elastic and nonlinear viscous beams by using six springs each acting about one of the six local degrees-of-freedom. The input consists of part ID's that reference material type, \*MAT\_ELASTIC\_SPRING\_DISCRETE\_BEAM above (type 74 above). Generally, these referenced parts are used only for the definition of this material model and are not referenced by any elements. The two nodes defining a beam may be coincident to give a zero length beam, or offset to give a finite length beam. For finite length discrete beams the absolute value of the variable SCOOR in the SECTION\_BEAM input should be set to a value of 2.0, which causes the local r-axis to be aligned along the two nodes of the beam to give physically correct behavior. The distance between the nodes of a beam should not affect the behavior of this material model. A triad is used to orient the beam for the directional springs.

Card 1            1            2            3            4            5            6            7            8

Variable	MID	RO	TPIDR	TPIDS	TPIDT	RPIDR	RPIDS	RPIDT
Type	A8	F	I	I	I	I	I	I

<u>VARIABLE</u>	<u>DESCRIPTION</u>
MID	Material identification. A unique number or label not exceeding 8 characters must be specified.
RO	Mass density, see also volume in *SECTION_BEAM definition.
TPIDR	Translational motion in the local r-direction is governed by part ID TPIDR. If zero, no force is computed in this direction.
TPIDS	Translational motion in the local s-direction is governed by part ID TPIDS. If zero, no force is computed in this direction.
TPIDT	Translational motion in the local t-direction is governed by part ID TPIDT. If zero, no force is computed in this direction.
RPIDR	Rotational motion about the local r-axis is governed by part ID RPIDR. If zero, no moment is computed about this axis.
RPIDS	Rotational motion about the local s-axis is governed by part ID RPIDS. If zero, no moment is computed about this axis.
RPIDT	Rotational motion about the local t-axis is governed by part ID RPIDT. If zero, no moment is computed about this axis.

**\*MAT\_INELASTIC\_SPRING\_DISCRETE\_BEAM**

This is Material Type 94. This model permits elastoplastic springs with damping to be represented with a discrete beam element type 6. A yield force versus deflection curve is used which can vary in tension and compression.

Card 1            1            2            3            4            5            6            7            8

Variable	MID	RO	K	F0	D	CDF	TDF	
Type	A8	F	F	F	F	F	F	

Card 2            1            2            3            4            5            6            7            8

Variable	FLCID	HLCID	C1	C2	DLE	GLCID		
Type	F	F	F	F	F	I		

<u>VARIABLE</u>	<u>DESCRIPTION</u>
MID	Material identification. A unique number or label not exceeding 8 characters must be specified.
RO	Mass density, see also volume in *SECTION_BEAM definition.
K	Elastic loading/unloading stiffness. This is required input.
F0	Optional initial force. This option is inactive if this material is referenced in a part referenced by material type *MAT_INELASTIC_6DOF_SPRING
D	Optional viscous damping coefficient.
CDF	Compressive displacement at failure. Input as a positive number. After failure, no forces are carried. This option does not apply to zero length springs. EQ.0.0: inactive.
TDF	Tensile displacement at failure. After failure, no forces are carried. EQ.0.0: inactive.

VARIABLE	DESCRIPTION
FLCID	Load curve ID, see *DEFINE_CURVE, defining the yield force versus plastic deflection. If the origin of the curve is at (0,0) the force magnitude is identical in tension and compression, i.e., only the sign changes. If not, the yield stress in the compression is used when the spring force is negative. The plastic displacement increases monotonically in this implementation. The load curve is required input.
HLCID	Load curve ID, see *DEFINE_CURVE, defining force versus relative velocity (Optional). If the origin of the curve is at (0,0) the force magnitude is identical for a given magnitude of the relative velocity, i.e., only the sign changes.
C1	Damping coefficient.
C2	Damping coefficient
DLE	Factor to scale time units.
GLCID	Optional load curve ID, see *DEFINE_CURVE, defining a scale factor versus deflection for load curve ID, HLCID. If zero, a scale factor of unity is assumed.

### **Remarks:**

The yield force is taken from the load curve:

$$F^Y = F_y(\Delta L^{plastic})$$

where  $L^{plastic}$  is the plastic deflection. A trial force is computed as:

$$F^T = F^n + K\Delta\dot{L}(\Delta t)$$

and is checked against the yield force to determine  $F$ :

$$F = \begin{cases} F^Y & \text{if } F^T > F^Y \\ F^T & \text{if } F^T \leq F^Y \end{cases}$$

The final force, which includes rate effects and damping, is given by:

$$F^{n+1} = F \cdot \left[ 1 + C1 \cdot \Delta\dot{L} + C2 \cdot \text{sgn}(\Delta\dot{L}) \ln \left( \max \left\{ 1, \frac{|\Delta\dot{L}|}{DLE} \right\} \right) \right] + D\Delta\dot{L} + g(\Delta L)h(\Delta\dot{L})$$

Unless the origin of the curve starts at (0,0), the negative part of the curve is used when the spring force is negative where the negative of the plastic displacement is used to interpolate,  $F_y$ . The positive part of the curve is used whenever the force is positive. In these equations,  $\Delta L$  is the change in length

$$\Delta L = \text{current length} - \text{initial length}$$

The cross sectional area is defined on the section card for the discrete beam elements, See \*SECTION\_BEAM. The square root of this area is used as the contact thickness offset if these elements are included in the contact treatment.

**\*MAT\_INELASTIC\_6DOF\_SPRING\_DISCRETE\_BEAM**

This is Material Type 95. This material model is defined for simulating the effects of nonlinear inelastic and nonlinear viscous beams by using six springs each acting about one of the six local degrees-of-freedom. The input consists of part ID's that reference material type, \*MAT\_INELASTIC\_SPRING\_DISCRETE\_BEAM above (type 94). Generally, these referenced parts are used only for the definition of this material model and are not referenced by any elements. The two nodes defining a beam may be coincident to give a zero length beam, or offset to give a finite length beam. For finite length discrete beams the absolute value of the variable SCOOR in the SECTION\_BEAM input should be set to a value of 2.0, which causes the local r-axis to be aligned along the two nodes of the beam to give physically correct behavior. The distance between the nodes of a beam should not affect the behavior of this material model. A triad must be used to orient the beam for zero length beams.

Card 1            1            2            3            4            5            6            7            8

Variable	MID	RO	TPIDR	TPIDS	TPIDT	RPIDR	RPIDS	RPIDT
Type	A8	F	I	I	I	I	I	I

<u>VARIABLE</u>	<u>DESCRIPTION</u>
MID	Material identification. A unique number or label not exceeding 8 characters must be specified.
RO	Mass density, see also volume in *SECTION_BEAM definition.
TPIDR	Translational motion in the local r-direction is governed by part ID TPIDR. If zero, no force is computed in this direction.
TPIDS	Translational motion in the local s-direction is governed by part ID TPIDS. If zero, no force is computed in this direction.
TPIDT	Translational motion in the local t-direction is governed by part ID TPIDT. If zero, no force is computed in this direction.
RPIDR	Rotational motion about the local r-axis is governed by part ID RPIDR. If zero, no moment is computed about this axis.
RPIDS	Rotational motion about the local s-axis is governed by part ID RPIDS. If zero, no moment is computed about this axis.
RPIDT	Rotational motion about the local t-axis is governed by part ID RPIDT. If zero, no moment is computed about this axis.

**\*MAT\_BRITTLE\_DAMAGE**

This is Material Type 96.

Card 1            1            2            3            4            5            6            7            8

Variable	MID	RO	E	PR	TLIMIT	SLIMIT	FTOUGH	SRETEN
Type	A8	F	F	F	F	F	F	F

Card 2            1            2            3            4            5            6            7            8

Variable	VISC	FRA_RF	E_RF	YS_RF	EH_RF	FS_RF	SIGY	
Type	F	F	F	F	F	F	F	

<u>VARIABLE</u>	<u>DESCRIPTION</u>
MID	Material identification. A unique number or label not exceeding 8 characters must be specified.
RO	Mass density.
E	Young's modulus.
PR	Poisson's ratio.
TLIMIT	Tensile limit.
SLIMIT	Shear limit.
FTOUGH	Fracture toughness.
SRETEN	Shear retention.
VISC	Viscosity.
FRA_RF	Fraction of reinforcement in section.
E_RF	Young's modulus of reinforcement.
YS_RF	Yield stress of reinforcement.



VARIABLE	DESCRIPTION
EH_RF	Hardening modulus of reinforcement.
FS_RF	Failure strain (true) of reinforcement.
SIGY	Compressive yield stress. EQ.0: no compressive yield

### **Remarks:**

A full description of the tensile and shear damage parts of this material model is given in Govindjee, Kay and Simo [1994,1995]. It is an anisotropic brittle damage model designed primarily for concrete though it can be applied to a wide variety of brittle materials. It admits progressive degradation of tensile and shear strengths across smeared cracks that are initiated under tensile loadings. Compressive failure is governed by a simplistic J2 flow correction that can be disabled if not desired. Damage is handled by treating the rank 4 elastic stiffness tensor as an evolving internal variable for the material. Softening induced mesh dependencies are handled by a characteristic length method [Oliver 1989].

Description of properties:

1.  $E$  is the Young's modulus of the undamaged material also known as the virgin modulus.
2.  $\nu$  is the Poisson's ratio of the undamaged material also known as the virgin Poisson's ratio.
3.  $f_n$  is the initial principal tensile strength (stress) of the material. Once this stress has been reached at a point in the body a smeared crack is initiated there with a normal that is co-linear with the 1st principal direction. Once initiated, the crack is fixed at that location, though it will convect with the motion of the body. As the loading progresses the allowed tensile traction normal to the crack plane is progressively degraded to a small machine dependent constant.

The degradation is implemented by reducing the material's modulus normal to the smeared crack plane according to a maximum dissipation law that incorporates exponential softening. The restriction on the normal tractions is given by

$$\phi_t = (\mathbf{n} \otimes \mathbf{n}) : \boldsymbol{\sigma} - f_n + (1 - \varepsilon) f_n (1 - \exp[-H\alpha]) \leq 0$$

where  $\mathbf{n}$  is the smeared crack normal,  $\varepsilon$  is the small constant,  $H$  is the softening modulus, and  $\alpha$  is an internal variable.  $H$  is set automatically by the program; see  $g_c$  below.  $\alpha$  measures the crack field intensity and is output in the equivalent plastic strain field,  $\bar{\varepsilon}^p$ , in a normalized fashion.

The evolution of alpha is governed by a maximum dissipation argument. When the normalized value reaches unity it means that the material's strength has been reduced to

2% of its original value in the normal and parallel directions to the smeared crack. Note that for plotting purposes it is never output greater than 5.

4.  $f_s$  is the initial shear traction that may be transmitted across a smeared crack plane. The shear traction is limited to be less than or equal to  $f_s(1-\beta)(1-\exp[-H\alpha])$ , through the use of two orthogonal shear damage surfaces. Note that the shear degradation is coupled to the tensile degradation through the internal variable alpha which measures the intensity of the crack field.  $\beta$  is the shear retention factor defined below. The shear degradation is taken care of by reducing the material's shear stiffness parallel to the smeared crack plane.
5.  $g_c$  is the fracture toughness of the material. It should be entered as fracture energy per unit area crack advance. Once entered the softening modulus is automatically calculated based on element and crack geometries.
6.  $\beta$  is the shear retention factor. As the damage progresses the shear tractions allowed across the smeared crack plane asymptote to the product  $\beta f_s$ .
7.  $\eta$  represents the viscosity of the material. Viscous behavior is implemented as a simple Perzyna regularization method. This allows for the inclusion of first order rate effects. The use of some viscosity is recommend as it serves as regularizing parameter that increases the stability of calculations.
8.  $\sigma_y$  is a uniaxial compressive yield stress. A check on compressive stresses is made using the J2 yield function  $\mathbf{s}:\mathbf{s}-\sqrt{\frac{2}{3}}\sigma_y \leq 0$ , where  $\mathbf{s}$  is the stress deviator. If violated, a J2 return mapping correction is executed. This check is executed when (1) no damage has taken place at an integration point yet, (2) when damage has taken place at a point but the crack is currently closed, and (3) during active damage after the damage integration (i.e. as an operator split). Note that if the crack is open the plasticity correction is done in the plane-stress subspace of the crack plane.

A variety of experimental data has been replicated using this model from quasi-static to explosive situations. Reasonable properties for a standard grade concrete would be  $E=3.15 \times 10^6$  psi,  $f_n=450$  psi,  $f_s=2100$  psi,  $\nu=0.2$ ,  $g_c=0.8$  lbs/in,  $\beta=0.03$ ,  $\eta=0.0$  psi-sec,  $\sigma_y=4200$  psi. For stability, values of  $\eta$  between 104 to 106 psi/sec are recommended. Our limited experience thus far has shown that many problems require nonzero values of  $\eta$  to run to avoid error terminations.

Various other internal variables such as crack orientations and degraded stiffness tensors are internally calculated but currently not available for output.

\*MAT\_GENERAL\_JOINT\_DISCRETE\_BEAM

This is Material Type 97. This model is used to define a general joint constraining any combination of degrees of freedom between two nodes. The nodes may belong to rigid or deformable bodies. In most applications the end nodes of the beam are coincident and the local coordinate system (r,s,t axes) is defined by CID (see \*SECTION\_BEAM).

Card 1            1            2            3            4            5            6            7            8

Variable	MID	RO	TR	TS	TT	RR	RS	RT
Type	A8	F	I	I	I	I	I	
Remarks	1							

Card 2            1            2            3            4            5            6            7            8

Variable	RPST	RPSR						
Type	F	F						
Remarks	2							

<u>VARIABLE</u>	<u>DESCRIPTION</u>
MID	Material identification. A unique number or label not exceeding 8 characters must be specified.
RO	Mass density, see also volume in *SECTION_BEAM definition.
TR	Translational constraint code along the r-axis (0 => free, 1 => constrained)
TS	Translational constraint code along the s-axis (0 => free, 1 => constrained)
TT	Translational constraint code along the t-axis (0 => free, 1 => constrained)
RR	Rotational constraint code about the r-axis (0 => free, 1 => constrained)

<u>VARIABLE</u>	<u>DESCRIPTION</u>
RS	Rotational constraint code about the s-axis (0 => free, 1 => constrained)
RT	Rotational constraint code about the t-axis (0 => free, 1 => constrained)
RPST	Penalty stiffness scale factor for translational constraints.
RPSR	Penalty stiffness scale factor for rotational constraints.

**Remarks:**

1. For explicit calculations, the additional stiffness due to this joint may require addition mass and inertia for stability. Mass and rotary inertia for this beam element is based on the defined mass density, the volume, and the mass moment of inertia defined in the \*SECTION\_BEAM input.
2. The penalty stiffness applies to explicit calculations. For implicit calculations, constraint equations are generated and imposed on the system equations; therefore, these constants, RPST and RPSR, are not used.

\*MAT\_SIMPLIFIED\_JOHNSON\_COOK

This is Material Type 98. The Johnson/Cook strain sensitive plasticity is used for problems where the strain rates vary over a large range. In this simplified model, thermal effects and damage are ignored, and the maximum stress is directly limited since thermal softening which is very significant in reducing the yield stress under adiabatic loading is not available. An iterative plane stress update is used for the shell elements, but due to the simplifications related to thermal softening and damage, this model is 50% faster than the full Johnson/Cook implementation. To compensate for the lack of thermal softening, limiting stress values are used to keep the stresses within reasonable limits. A resultant formulation for the Belytschko-Tsay, the C0 Triangle, and the fully integrated type 16 shell elements is activated by specifying either zero or one through thickness integration point on the \*SHELL\_SECTION card. This latter option is less accurate than through thickness integration but is somewhat faster. Since the stresses are not computed in the resultant formulation, the stress output to the databases for the resultant elements are zero. This model is also available for the Hughes-Liu beam, the Belytschko-Schwer beam, and the truss element. For the resultant beam formulation, the rate effects are approximated by the axial rate since the thickness of the beam about its bending axes is unknown. The linear bulk modulus is used to determine the pressure in the elements, since the use of this model is primarily for structural analysis.

Card 1            1            2            3            4            5            6            7            8

Variable	MID	RO	E	PR	VP			
Type	A8	F	F	F	F			
Default	none	none	none	none	0.0			

Card 2            1            2            3            4            5            6            7            8

Variable	A	B	N	C	PSFAIL	SIGMAX	SIGSAT	EPSO
Type	F	F	F	F	F	F	F	F
Default	none	0.0	0.0	0.0	1.0E+17	SIGSAT	1.0E+28	1.0

VARIABLE

DESCRIPTION

MID            Material identification. A unique number or label not exceeding 8 characters must be specified.

<u>VARIABLE</u>	<u>DESCRIPTION</u>
RO	Mass density
E	Young's modulus
PR	Poisson's ratio
VP	Formulation for rate effects: EQ.0.0: Scale yield stress (default), EQ.1.0: Viscoplastic formulation. This option applies only to the 4-node shell and 8-node thick shell if and only if through thickness integration is used.
A	See equations below.
B	See equations below.
N	See equations below.
C	See equations below.
PSFAIL	Effective plastic strain at failure. If zero failure is not considered.
SIGMAX	Maximum stress obtainable from work hardening before rate effects are added (optional). This option is ignored if VP=1.0
SIGSAT	Saturation stress which limits the maximum value of effective stress which can develop after rate effects are added (optional).
EPS0	Quasi-static threshold strain rate. See description under *MAT_015.

**Remarks:**

Johnson and Cook express the flow stress as

$$\sigma_y = \left( A + B \bar{\epsilon}^{p^n} \right) \left( 1 + c \ln \dot{\epsilon}^* \right)$$

where

A, B, C and n are input constants

$\bar{\epsilon}^p$  effective plastic strain

$$\dot{\epsilon}^* = \frac{\dot{\bar{\epsilon}}}{EPS0} \text{ normalized effective strain rate}$$

The maximum stress is limited by *sigmax* and *sigsat* by:

$$\sigma_y = \min \left\{ \min \left[ A + B \bar{\epsilon}^n, \text{sigmax} \right] \left( 1 + c \ln \dot{\epsilon}^* \right), \text{sigsat} \right\}$$

Failure occurs when the effective plastic strain exceeds *psfail*.

If the viscoplastic option is active, VP=1.0, the parameters SIGMAX and SIGSAT are ignored since these parameters make convergence of the viscoplastic strain iteration loop difficult to achieve. The viscoplastic option replaces the plastic strain in the forgoing equations by the viscoplastic strain and the strain rate by the viscoplastic strain rate. Numerical noise is substantially reduced by the viscoplastic formulation.

**\*MAT\_099 \*MAT\_SIMPLIFIED\_JOHNSON\_COOK\_ORTHOTROPIC\_DAMAGE**

**\*MAT\_SIMPLIFIED\_JOHNSON\_COOK\_ORTHOTROPIC\_DAMAGE**

This is Material Type 99. This model, which is implemented with multiple through thickness integration points, is an extension of model 98 to include orthotropic damage as a means of treating failure in aluminum panels. Directional damage begins after a defined failure strain is reached in tension and continues to evolve until a tensile rupture strain is reached in either one of the two orthogonal directions. After rupture is detected at NUMINT integration points, the element is deleted.

Card 1	1	2	3	4	5	6	7	8
Variable	MID	RO	E	PR	VP	EPPFR	LCDM	NUMINT
Type	A8	F	F	F	F	F	I	I
Default	none	none	none	none	0.0	1.e+16	optional	all intg. pt

Card 2	1	2	3	4	5	6	7	8
Variable	A	B	N	C	PSFAIL	SIGMAX	SIGSAT	EPSO
Type	F	F	F	F	F	F	F	F
Default	none	0.0	0.0	0.0	1.0E+17	SIGSAT	1.0E+28	1.0

<u>VARIABLE</u>	<u>DESCRIPTION</u>
MID	Material identification. A unique number or label not exceeding 8 characters must be specified.
RO	Mass density
E	Young's modulus
PR	Poisson's ratio
VP	Formulation for rate effects: EQ.0.0: Scale yield stress (default), EQ.1.0: Viscoplastic formulation. This option applies only to the 4-node shell and 8-node thick shell if and only if through thickness integration is used.



## \*MAT\_SIMPLIFIED\_JOHNSON\_COOK\_ORTHOTROPIC\_DAMAGE \*MAT\_099

<u>VARIABLE</u>	<u>DESCRIPTION</u>
EPPFR	Plastic strain at which material ruptures (logarithmic).
LCDM	Load curve ID defining nonlinear damage curve. See Figure 81-82.2.
NUMINT	Number of through thickness integration points which must fail before the element is deleted. (If zero, all points must fail.) The default of all integration points is not recommended since elements undergoing large strain are often not deleted due to nodal fiber rotations which limit 0strains at active integration points after most points have failed. Better results are obtained if NUMINT is set to 1 or a number less than one half of the number of through thickness points. For example, if four through thickness points are used, NUMINT should not exceed 2, even for fully integrated shells which have 16 integration points.
A	See equations below.
B	See equations below.
N	See equations below.
C	See equations below.
PSFAIL	Principal plastic strain at failure. If zero failure is not considered.
SIGMAX	Maximum stress obtainable from work hardening before rate effects are added (optional). This option is ignored if VP=1.0
SIGSAT	Saturation stress which limits the maximum value of effective stress which can develop after rate effects are added (optional).
EPS0	Quasi-static threshold strain rate. See description under *MAT_015.

### **Remarks:**

See the description for the SIMPLIFIED\_JOHNSON\_COOK model above.

**\*MAT\_SPOTWELD\_{OPTION}**

This is Material Type 100. The material model applies to beam element type 9 and to solid element type 1 with type 6 hourglass controls. The failure models apply to both beam and solid elements.

The beam elements, based on the Hughes-Liu beam formulation, may be placed between any two deformable shell surfaces and tied with constraint contact, **\*CONTACT\_SPOTWELD**, which eliminates the need to have adjacent nodes at spot weld locations. Beam spot welds may be placed between rigid bodies and rigid/deformable bodies by making the node on one end of the spot weld a rigid body node which can be an extra node for the rigid body, see **\*CONSTRAINED\_EXTRA\_NODES\_OPTION**. In the same way rigid bodies may also be tied together with this spot weld option. This weld option should not be used with rigid body switching. The foregoing advice is valid if solid element spot welds are used; however, since the solid elements have just three degrees-of-freedom at each node, **\*CONTACT\_TIED\_SURFACE\_TO\_SURFACE** must be used instead of **\*CONTACT\_SPOTWELD**.

In flat topologies the shell elements have an unconstrained drilling degree-of-freedom which prevents torsional forces from being transmitted. If the torsional forces are deemed to be important, brick elements should be used to model the spot welds.

Beam and solid element force resultants for **MAT\_SPOTWELD** are written to the spot weld force file, **SWFORC**, and the file for element stresses and resultants for designated elements, **ELOUT**.

**It is advisable to include all spot welds, which provide the slave nodes, and spot welded materials, which define the master segments, within a single \*CONTACT\_SPOTWELD interface for beam element spot welds or a \*CONTACT\_TIED\_SURFACE\_TO\_SURFACE interface for solid element spot welds.** As a constraint method these interfaces are treated independently which can lead to significant problems if such interfaces share common nodal points. An added benefit is that memory usage can be substantially less with a single interface.

Available options include:

**<BLANK>**

**DAMAGE-FAILURE**

The **DAMAGE-FAILURE** option causes one additional line to be read with the damage parameter and a flag that determines how failure is computed from the resultants. On this line the parameter, **RS**, if nonzero, invokes damage mechanics combined with the plasticity model to achieve a smooth drop off of the resultant forces prior to the removal of the spot weld. The parameter **OPT** determines the method used in computing resultant based failure, which is unrelated to damage.

Card 1            1            2            3            4            5            6            7            8

Variable	MID	RO	E	PR	SIGY	ET	DT	TFAIL
Type	A8	F	F	F	F	F	F	F

**Define this card as Card 2 when the DAMAGE-FAILURE option is inactive. Card 3 is not defined**

Card 2            1            2            3            4            5            6            7            8

Variable	EFAIL	NRR	NRS	NRT	MRR	MSS	MTT	NF
Type	F	F	F	F	F	F	F	F

**OPT=-1.0 and 0.0, Resultant based failure.  
Define cards 2 and 3 below if the DAMAGE-FAILURE option is active.**

Card 2            1            2            3            4            5            6            7            8

Variable	EFAIL	NRR	NRS	NRT	MRR	MSS	MTT	NF
Type	F	F	F	F	F	F	F	F

**OPT=1.0, Stress based failure.**

Card 2            1            2            3            4            5            6            7            8

Variable	EFAIL	SIGAX	SIGTAU					NF
Type	F	F	F					F

**OPT=1.0, Stress based failure if strain rate effects are included**

Card 2            1            2            3            4            5            6            7            8

Variable	EFAIL	-LCAX	-LCTAU					NF
Type	F	F	F					F

**OPT=2.0, User subroutine for failure**

Card 2            1            2            3            4            5            6            7            8

Variable	EFAIL	USERV1	USERV2	USERV3	USERV4	USERV5	USERV6	NF
Type	F	F	F	F	F	F	F	F

**OPT=3.0, 4.0**

Card 2            1            2            3            4            5            6            7            8

Variable	EFAIL	ZD	ZT	ZALP1	ZALP2	ZALP3	ZRRAD	NF
Type	F	F	F	F	F	F	F	F

**OPT=5.0**

Card 2            1            2            3            4            5            6            7            8

Variable	EFAIL	ZD	ZT	ZT2				
Type	F	F	F	F				

**OPT=6.0, 7.0, and 9.0**

Card 2            1            2            3            4            5            6            7            8

Variable	EFAIL								NF
Type	F								F

**Card 3 is defined only for the DAMAGE-FAILURE option.**

Card 3            1            2            3            4            5            6            7            8

Variable	RS	OPT	FVAL	TRUE_T	ASFF	BETA			DMGOPT
Type	F	F	F	F	I	F			F

<u>VARIABLE</u>	<u>DESCRIPTION</u>
MID	Material identification. A unique number or label not exceeding 8 characters must be specified.
RO	Mass density
E	Young's modulus
PR	Poisson's ratio
SIGY	SIGY.GT.0: Initial yield stress. SIGY.LT.0: A yield curve or table is assigned by  SIGY . This option is available for beams and starting with release 971 R5.
ET	Hardening modulus, $E_t$
DT	Time step size for mass scaling, $\Delta t$
TFAIL	Failure time if nonzero. If zero this option is ignored.
EFAIL	Effective plastic strain in weld material at failure. If the damage option is inactive, the spot weld element is deleted when the plastic strain at each integration point exceeds EFAIL. If the damage option is active, the plastic strain must exceed the rupture strain at each integration point before deletion occurs.
NRR	Axial force resultant $N_{rr}$ or maximum axial stress $\sigma_{rr}^F$ at failure depending

VARIABLE	DESCRIPTION
	on the value of OPT (see below). If zero, failure due to this component is not considered. If negative,  NRR  is the load curve ID defining the maximum axial stress at failure as a function of the effective strain rate.
NRS	Force resultant $N_{rsF}$ or maximum shear stress $\tau^F$ at failure depending on the value of OPT (see below). If zero, failure due to this component is not considered. If negative,  NRS  is the load curve ID defining the maximum shear stress at failure as a function of the effective strain rate.
NRT	Force resultant $N_{rtF}$ at failure. If zero, failure due to this component is not considered.
MRR	Torsional moment resultant $M_{rtF}$ at failure. If zero, failure due to this component is not considered.
MSS	Moment resultant $M_{ssF}$ at failure. If zero, failure due to this component is not considered.
MTT	Moment resultant $M_{ttF}$ at failure. If zero, failure due to this component is not considered.
NF	Number of force vectors stored for filtering. The default value is set to zero which is generally recommended unless oscillatory resultant forces are observed in the time history databases. Even though these welds should not oscillate significantly, this option was added for consistency with the other spot weld options. NF affects the storage since it is necessary to store the resultant forces as history variables. When NF is nonzero, the resultants in the output databases are filtered. NF cannot exceed 30.
SIGAX	Maximum axial stress $\sigma_{rr}^F$ at failure. If zero, failure due to this component is not considered.
SIGTAU	Maximum shear stress $\tau^F$ at failure. If zero, failure due to this component is not considered.
LCAX	Load curve ID defining the maximum axial stress at failure as a function of the effective strain rate. Input as a negative number.
LCTAU	Load curve ID defining the maximum shear stress at failure as a function of the effective strain rate. Input as a negative number.
USERVn	Failure constants for user failure subroutine, n=1,2,...6.
ZD	Notch diameter

VARIABLE	DESCRIPTION
ZT	Sheet thickness.
ZALP1	Correction factor alpha1
ZALP2	Correction factor alpha2
ZALP3	Correction factor alpha3
ZRRAD	Notch root radius (OPT=3.0 only).
ZT2	Second sheet thickness (OPT = 5.0 only)
RS	Rupture strain. Define if and only if damage is active.
OPT	<p>Failure option:</p> <p>EQ.-2: same as option -1 but in addition, the peak value of the failure criteria and the time it occurs is stored and is written into the SWFORC database. This information may be necessary since the instantaneous values written at specified time intervals may miss the peaks. Additional storage is allocated to store this information.</p> <p>EQ.-1: resultant based failure criteria, <math>FC</math>, is computed based on the force and moment resultants and is written into the SWFORC file. <i>Failure is not allowed.</i> This allows easy identification of vulnerable spot welds in the post-processing. Failure is likely to occur if <math>FC &gt; 1.0</math>. Only the terms where the corresponding failure resultant is nonzero are included when <math>FC</math> is calculated. This option applies to both solid and beam elements.</p> $FC = \sqrt{\left(\frac{\max(N_{rr}, 0)}{N_{rrF}}\right)^2 + \left(\frac{N_{rs}}{N_{rsF}}\right)^2 + \left(\frac{N_{rt}}{N_{rtF}}\right)^2 + \left(\frac{M_{rr}}{M_{rrF}}\right)^2 + \left(\frac{M_{ss}}{M_{ssF}}\right)^2 + \left(\frac{M_{tt}}{M_{ttF}}\right)^2}$ <p>EQ. 0: resultant based failure  EQ. 1: stress based failure computed from resultants (Toyota)  EQ. 2: user subroutine uweldfail to determine failure  EQ. 3: notch stress based failure (beam weld only)  EQ. 4: stress intensity factor at failure (beam weld only)  EQ. 5: structural stress at failure (beam weld only).  EQ. 6: stress based failure computed from resultants (Toyota). In this option a shell strain rate dependent failure model is used (beam weld only). The static failure stresses are defined by part ID using the input given in the keyword definition *DEFINE_SPOTWELD_RUPTURE_STRESS input.  EQ. 7: stress based failure for solid elements (Toyota) with peak stresses computed from resultants, and strength values input for pairs of parts, see *DEFINE_SPOTWELD_FAILURE_RESULTANTS. Strain rate effects are optional.</p>

VARIABLE	DESCRIPTION
OPT	<p>EQ. 8: Not used.</p> <p>EQ. 9: Stress based failure from resultants (Toyota). In this option a shell strain rate dependent failure model is used (beam weld only). The static failure stresses are defined by part ID using the input given in the keyword definition *DEFINE_SPOTWELD_RUPTURE_PARAMETER input.</p> <p>EQ. 12. user subroutine uweldfail12 with 22 material constants to determine damage and failure.</p> <p>EQ. 22. user subroutine uweldfail22 with 22 material constants to determine failure.</p>
FVAL	<p>Failure parameter. If OPT:</p> <p>EQ.-2: Not used.</p> <p>EQ.-1: Not used.</p> <p>EQ. 0: Not used.</p> <p>EQ. 1: Not used.</p> <p>EQ. 2: Not used.</p> <p>EQ. 3: Notch stress value at failure (<math>\sigma_{KF}</math>).</p> <p>EQ. 4: Stress intensity factor value at failure (<math>K_{eqF}</math>).</p> <p>EQ. 5: Structural stress value at failure (<math>\sigma_{SF}</math>).</p> <p>EQ. 6: Number of cycles that failure condition must be met to trigger beam deletion.</p> <p>EQ. 7: Not used.</p> <p>EQ. 9: Number of cycles that failure condition must be met to trigger beam deletion.</p>
TRUE_T	<p>True weld thickness. This optional value is available for solid element failure by OPT=0,1,7, -1 or -2. TRUE_T is used to reduce the moment contribution to the failure calculation from artificially thick weld elements so shear failure can be modeled more accurately. See comments under the remarks for *MAT_SPOTWELD_DAIMLER CHRYSLER</p>
ASFF	<p>Weld assembly simultaneous failure flag</p> <p>EQ. 0: Damaged elements fail individually.</p> <p>EQ. 1: Damaged elements fail when first reaches failure criterion.</p>
BETA	<p>Damage model decay rate.</p>
DMGOPT	<p>Damage option flag. If DMGOPT:</p> <p>EQ. 0: Plastic strain based damage.</p> <p>EQ. 1: Plastic strain based damage with post damage stress limit</p> <p>EQ. 2: Time based damage with post damage stress limit</p> <p>EQ. 10: Like DMGOPT=0, but failure option will initiate damage</p> <p>EQ. 11: Like DMGOPT=1, but failure option will initiate damage</p> <p>EQ. 12: Like DMGOPT=2, but failure option will initiate damage</p>



**Remarks:**

The weld material is modeled with isotropic hardening plasticity coupled to failure models. EFAIL specifies a failure strain which fails each integration point in the spot weld independently. The resultant-based failure model fails the entire weld if the resultants are outside of the failure surface defined by:

$$\left( \frac{\max(N_{rr}, 0)}{N_{rrF}} \right)^2 + \left( \frac{N_{rs}}{N_{rsF}} \right)^2 + \left( \frac{N_{rt}}{N_{rtF}} \right)^2 + \left( \frac{M_{rr}}{M_{rrF}} \right)^2 + \left( \frac{M_{ss}}{M_{ssF}} \right)^2 + \left( \frac{M_{tt}}{M_{ttF}} \right)^2 - 1 = 0$$

where the *numerators* in the equation are the resultants calculated in the local coordinates of the cross section, and the **denominators** are the values specified in the input. If NF is nonzero the resultants are filtered before failure is checked. The stress based failure model (OPT=1), which was developed by *Toyota Motor Corporation* and is based on the peak axial and transverse shear stresses, fails the entire weld if the stresses are outside of the failure surface defined by

$$\left( \frac{\sigma_{rr}}{\sigma_{rr}^F} \right)^2 + \left( \frac{\tau}{\tau^F} \right)^2 - 1 = 0$$

If strain rates are considered then the failure criteria becomes:

$$\left( \frac{\sigma_{rr}}{\sigma_{rr}^F(\dot{\epsilon}_{eff})} \right)^2 + \left( \frac{\tau}{\tau^F(\dot{\epsilon}_{eff})} \right)^2 - 1 = 0$$

where  $\sigma_{rr}^F(\dot{\epsilon}_{eff})$  and  $\tau^F(\dot{\epsilon}_{eff})$  are defined by load curves LCAX and LCTAU. The peak stresses are calculated from the resultants using simple beam theory.

$$\sigma_{rr} = \frac{N_{rr}}{A} + \frac{\sqrt{M_{ss}^2 + M_{tt}^2}}{Z} \quad \tau = \frac{M_{rr}}{2Z} + \frac{\sqrt{N_{rs}^2 + N_{rt}^2}}{A}$$

where the area and section modulus are given by:

$$A = \pi \frac{d^2}{4}$$

$$Z = \pi \frac{d^3}{32}$$

and  $d$  is the equivalent diameter of the beam element or solid element used as a spot weld.

OPT=2 invokes a user-written subroutine *uweldfail*, documented in Appendix Q.

The failure based on notch stress (OPT=3), see Zhang [1999], occurs when the failure criterion:

$$\sigma_k - \sigma_{kF} \geq 0$$

is satisfied. The notch stress is give by the equation:

$$\sigma_k = \alpha_1 \frac{4F}{\pi dt} \left( 1 + \frac{\sqrt{3} + \sqrt{19}}{8\sqrt{\pi}} \sqrt{\frac{t}{\rho}} \right) + \alpha_2 \frac{6M}{\pi dt^2} \left( 1 + \frac{2}{\sqrt{3\pi}} \sqrt{\frac{t}{\rho}} \right) + \alpha_3 \frac{4F_{rr}}{\pi d^2} \left( 1 + \frac{5}{3\sqrt{2\pi}} \frac{d}{t} \sqrt{\frac{t}{\rho}} \right)$$

Here,

$$F = \sqrt{F_{rs}^2 + F_{rt}^2}$$

$$M = \sqrt{M_{ss}^2 + M_{tt}^2}$$

and  $\alpha_i$   $i=1,2,3$  are input corrections factors with default values of unity. If spot welds are between sheets of unequal thickness, the minimum thickness of the spot welded sheets may be introduced as a crude approximation.

The failure based on structural stress intensity (OPT=4) occurs, see Zhang [1999], when the failure criterion:

$$K_{eq} - K_{eqF} \geq 0$$

is satisfied where

$$K_{eq} = \sqrt{K_I^2 + K_{II}^2}$$

and

$$K_I = \alpha_1 \frac{\sqrt{3}F}{2\pi d\sqrt{t}} + \alpha_2 \frac{2\sqrt{3}M}{\pi dt\sqrt{t}} + \alpha_3 \frac{5\sqrt{2}F_{rr}}{3\pi d\sqrt{t}}$$

$$K_{II} = \alpha_1 \frac{2F}{\pi d\sqrt{t}}$$

Here, F and M are as defined above for the notch stress formulas and again,  $\alpha_i$   $i=1,2,3$  are input corrections factors with default values of unity. If spot welds are between sheets of unequal thickness, the minimum thickness of the spot welded sheets may be used as a crude approximation.

The maximum structural stress at the spot weld was utilized successfully for predicting the fatigue failure of spot welds, see Rupp, et. al. [1994] and Sheppard [1993]. The corresponding results according to Rupp, et. al. are listed below where it is assumed that they may be suitable for crash conditions.

The failure criterion invoked by OPT=5 is given by:

$$\max(\sigma_{v1}, \sigma_{v2}, \sigma_{v3}) - \sigma_{sF} = 0$$

where  $\sigma_{sF}$  is the critical value of structural stress at failure. It is noted that the forces and moments in the equations below are referred to the beam nodes 1, 2, and to the midpoint, respectively. The three stress values,  $\sigma_{v1}, \sigma_{v2}, \sigma_{v3}$ , are defined by:

$$\sigma_{v1}(\zeta) = \frac{F_{rs1}}{\pi dt_1} \cos \zeta + \frac{F_{rt1}}{\pi dt_1} \sin \zeta - \frac{1.046\beta_1 F_{rr1}}{t_1 \sqrt{t_1}} - \frac{1.123M_{ss1}}{dt_1 \sqrt{t_1}} \sin \zeta + \frac{1.123M_{tt1}}{dt_1 \sqrt{t_1}} \cos \zeta \quad \text{with}$$

$$\beta_1 = 0 \quad \text{if } F_{rr1} \leq 0$$

$$\beta_1 = 1 \quad \text{if } F_{rr1} > 0$$

$$\sigma_{v2}(\zeta) = \frac{F_{rs2}}{\pi dt_2} \cos \zeta + \frac{F_{rt2}}{\pi dt_2} \sin \zeta - \frac{1.046\beta_1 F_{rr2}}{t_2 \sqrt{t_2}} + \frac{1.123M_{ss2}}{dt_2 \sqrt{t_2}} \sin \zeta - \frac{1.123M_{tt2}}{dt_2 \sqrt{t_2}} \cos \zeta \quad \text{with}$$

$$\beta_2 = 0 \quad \text{if } F_{rr2} \leq 0$$

$$\beta_2 = 1 \quad \text{if } F_{rr2} > 0$$

$$\sigma_{v3}(\zeta) = 0.5\sigma(\zeta) + 0.5\sigma(\zeta)\cos(2\alpha) + 0.5\tau(\zeta)\sin(2\alpha)$$

where

$$\sigma(\zeta) = \frac{4\beta_3 F_{rr}}{\pi d^2} + \frac{32M_{ss}}{\pi d^3} \sin \zeta - \frac{32M_{tt}}{\pi d^3} \cos \zeta$$

$$\tau(\zeta) = \frac{16F_{rs}}{3\pi d^2} \sin^2 \zeta + \frac{16F_{rt}}{3\pi d^2} \cos^2 \zeta \quad \text{with } \begin{matrix} \beta_3 = 0 & \text{if } F_{rr} \leq 0 \\ \beta_3 = 1 & \text{if } F_{rr} > 0 \end{matrix}$$

$$\alpha = \frac{1}{2} \tan^{-1} \frac{2\tau(\zeta)}{\sigma(\zeta)}$$

The stresses are calculated for all directions,  $0^\circ \leq \zeta \leq 90^\circ$ , in order to find the maximum.

If the failure strain EFAIL is set to zero, the failure strain model is not used. In a similar manner, when the value of a resultant at failure is set to zero, the corresponding term in the failure surface is ignored. For example, if only  $N_{rr}$  is nonzero, the failure surface is reduced to  $|N_{rr}| = N_{rr}$ . None, either, or both of the failure models may be active depending on the specified input values.

The inertias of the spot welds are scaled during the first time step so that their stable time step size is  $\Delta t$ . A strong compressive load on the spot weld at a later time may reduce the length of the spot weld so that stable time step size drops below  $\Delta t$ . If the value of  $\Delta t$  is zero, mass scaling is not performed, and the spot welds will probably limit the time step size. Under most circumstances, the inertias of the spot welds are small enough that scaling them will have a negligible effect on the structural response and the use of this option is encouraged.

Spot weld force history data is written into the SWFORC ascii file. In this database the resultant moments are not available, but they are in the binary time history database and in the ASCII elout file.

When the DAMAGE-FAILURE option is invoked, the constitutive properties for the damaged material are obtained from the undamaged material properties. The amount of damage evolved is represented by the constant,  $\omega$ , which varies from zero if no damage has occurred to unity for complete rupture. For uniaxial loading, the nominal stress in the damaged material is given by

$$\sigma_{nominal} = \frac{P}{A}$$

where P is the applied load and A is the surface area. The true stress is given by:

$$\sigma_{true} = \frac{P}{A - A_{loss}}$$

where  $A_{loss}$  is the void area. The damage variable can then be defined:

$$\omega = \frac{A_{loss}}{A} \quad 0 \leq \omega \leq 1$$

In this model, damage is initiated when the effective plastic strain in the weld exceeds the failure strain, EFAIL. If DMGOPT=10, 11, or 12, damage will initiate when the effective plastic strain exceeds EFAIL, or when the failure criterion is met, whichever occurs first. The failure criterion is specified by OPT parameter. After damage initiates, the damage variable is evaluated by one of two ways. For DMGOPT=0, 1, 10, or 11, the damage variable is a function of effective plastic strain in the weld:

$$\omega = \frac{\epsilon_{eff}^p - \epsilon_{failure}^p}{\epsilon_{rupture}^p - \epsilon_{failure}^p} \quad \text{if } \epsilon_{failure}^p \leq \epsilon_{eff}^p \leq \epsilon_{rupture}^p$$

where  $\epsilon_{failure}^p = \text{EFAIL}$  and  $\epsilon_{rupture}^p = \text{RS}$ . For DMGOPT=2 or 12, the damage variable is a function of time:

$$\omega = \frac{t - t_{failure}}{t_{rupture}} \quad \text{if } t_{failure} \leq t \leq t_{rupture}$$

where  $t_{failure}$  is the time at which damage initiates, and  $t_{rupture} = \text{RS}$ . For this criteria,  $t_{failure}$  is set to either the time when  $\epsilon_{eff}^p$  exceeds EFAIL, or the time when the failure criterion is met.

For DMGOPT=1, the damage behavior is the same as for DMGOPT=0, but an additional damage variable is calculated to prevent stress growth during softening. Similarly, DMGOPT=11 behaves like DMGOPT=10 except for the additional damage variable. This additional function is also used with DMGOPT=2 and 12. The affect of this additional damage function is noticed only in brick and brick assembly welds in tension loading where it prevents growth of the tensile force in the weld after damage initiates.

If BETA is specified, the stress is multiplied by an exponential using  $\omega$  defined in the previous equations,

$$\sigma_d = \sigma \cdot \exp(-\beta\omega).$$

For weld elements in an assembly (see RPBHX on \*CONTROL\_SPOTWELD\_BEAM or \*DEFINE\_HEX\_SPOTWELD\_ASSEMBLY), the failure criterion is evaluated using the assembly cross section. If damage is not active, all elements will be deleted when the failure criterion is met. If damage is active, then damage is calculated independently in each element of the assembly. By default, elements of the assembly are deleted as damage in each element is complete. If ASFF=1, then failure and deletion of all elements in the assembly will occur simultaneously when damage is complete in any one of the elements.

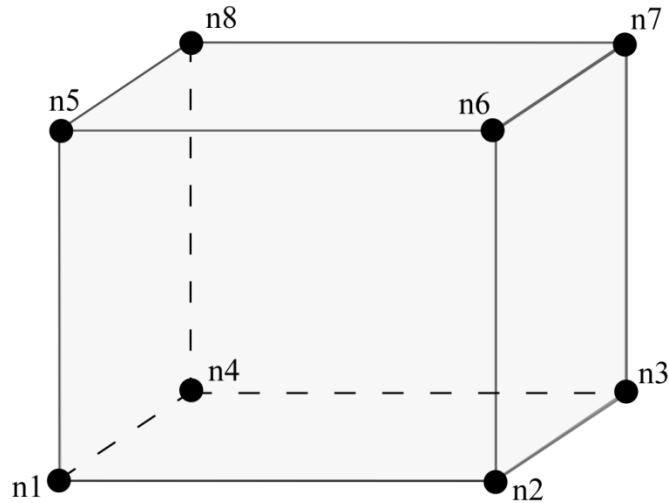

**Figure 100.1.** A solid element used as spot weld is shown. When resultant based failure is used orientation is very important. Nodes n1-n4 attach to the lower shell mid-surface and nodes n5-n8 attach to the upper shell mid-surface. The resultant forces and moments are computed based on the assumption that the brick element is properly oriented.

**\*MAT\_SPOTWELD\_DAIMLERCHRYSLER**

This is Material Type 100. The material model applies to solid element type 1 with type 6 hourglass control. Spot weld elements may be placed between any two deformable shell surfaces and tied with constraint contact, \*CONTACT\_TIED\_SURFACE\_TO\_SURFACE, which eliminates the need to have adjacent nodes at spot weld locations. Spot weld failure is modeled using this card and \*DEFINE\_CONNECTION\_PROPERTIES data. Details of the failure model can be found in Seeger, Feucht, Frank, Haufe, and Keding [2005].

**It is advisable to include all spot welds, which provide the slave nodes, and spot welded materials, which define the master segments, within a single \*CONTACT\_TIED\_SURFACE\_TO\_SURFACE interface.** This contact type uses constraint equations. If multiple interfaces are treated independently, significant problems can occur if such interfaces share common nodes. An added benefit is that memory usage can be substantially less with a single interface.

Card 1            1            2            3            4            5            6            7            8

Variable	MID	RO	E	PR			DT	TFAIL
Type	A8	F	F	F			F	F

Card 2            1            2            3            4            5            6            7            8

Variable	EFAIL							NF
Type	F							F

Card 3            1            2            3            4            5            6            7            8

Variable	RS	ASFF		TRUE_T	CON_ID			
Type	F	I		F	F			

<u>VARIABLE</u>	<u>DESCRIPTION</u>
MID	Material identification. A unique number or label not exceeding 8 characters must be specified.

<u>VARIABLE</u>	<u>DESCRIPTION</u>
RO	Mass density.
E	Young's modulus.
PR	Poisson's ratio.
DT	Time step size for mass scaling, $\Delta t$ .
TFAIL	Failure time if nonzero. If zero this option is ignored.
EFAIL	Effective plastic strain in weld material at failure. See remark below.
NF	Number of failure function evaluations stored for filtering by time averaging. The default value is set to zero which is generally recommended unless oscillatory resultant forces are observed in the time history databases. Even though these welds should not oscillate significantly, this option was added for consistency with the other spot weld options. NF affects the storage since it is necessary to store the failure terms. When NF is nonzero, the resultants in the output databases are filtered. NF cannot exceed 30.
RS	Rupture strain. See Remarks below.
ASFF	Weld assembly simultaneous failure flag EQ. 0: Damaged elements fail individually. EQ. 1: Damaged elements fail when first reaches failure criterion.
TRUE_T	True weld thickness for single hexahedron solid weld elements. See comments below.
CON_ID	Connection ID of *DEFINE_CONNECTION card.

**Remarks:**

This weld material is modeled with isotropic hardening plasticity. The yield stress and constant hardening modulus are assumed to be those of the welded shell elements as defined in a \*DEFINE\_CONNECTION\_PROPERTIES table. A failure function and damage type is also defined by \*DEFINE\_CONNECTION\_PROPERTIES data. The interpretation of EFAIL and RS is determined by the choice of damage type. This is discussed in remark 4 on \*DEFINE\_CONNECTION\_PROPERTIES.

Solid weld elements are tied to the mid-plane of shell materials and so typically have a thickness that is half the sum of the thicknesses of the welded shell sections. As a result, a weld under shear loading can be subject to an artificially large moment which will be balanced by normal forces transferred through the tied contact. These normal forces will cause the normal term in the failure calculation to be artificially high. Inputting a TRUE\_T that is smaller than the

modeled thickness, for example, 10%-30% of true thickness will scale down the normal force that results from the balancing moment and provide more realistic failure calculations. TRUE\_T effects only the failure calculation, not the weld element behavior. If TRUE\_T=0 or data is omitted, the modeled weld element thickness is used.

For weld elements in an assembly (see RPBHX on \*CONTROL\_SPOTWELD\_BEAM or \*DEFINE\_HEX\_SPOTWELD\_ASSEMBLY), the failure criterion is evaluated using the assembly cross section. If damage is not active, all elements will be deleted when the failure criterion is met. If damage is active, then damage is calculated independently in each element of the assembly. By default, elements of the assembly are deleted as damage in each element is complete. If ASFF=1, then failure and deletion of all elements in the assembly will occur simultaneously when damage is complete in any one of the elements.

Solid element force resultants for MAT\_SPOTWELD are written to the spot weld force file, SWFORC, and the file for element stresses and resultants for designated elements, ELOUT. Also, spot weld failure data is written to the file, DCFAIL.



\*MAT\_GEPLASTIC\_SRATE\_2000a

This is Material Type 101. The GEPLASTIC\_SRATE\_2000a material model characterizes General Electric's commercially available engineering thermoplastics subjected to high strain rate events. This material model features the variation of yield stress as a function of strain rate, cavitation effects of rubber modified materials and automatic element deletion of either ductile or brittle materials.

Card 1            1            2            3            4            5            6            7            8

Variable	MID	RO	E	PR	RATESF	EDOT0	ALPHA	
Type	A8	F	F	F	F	F	F	

Card 2            1            2            3            4            5            6            7            8

Variable	LCSS	LCFEPS	LCFSIG	LCE				
Type	F	F	F	F				

<u>VARIABLE</u>	<u>DESCRIPTION</u>
MID	Material identification. A unique number or label not exceeding 8 characters must be specified.
RO	Mass density.
E	Young's Modulus.
PR	Poisson's ratio.
RATESF	Constant in plastic strain rate equation.
EDOT0	Reference strain rate
ALPHA	Pressure sensitivity factor
LCSS	Load curve ID or Table ID that defines the post yield material behavior. The values of this stress-strain curve are the difference of the yield stress and strain respectively. This means the first values for both stress and strain should be zero. All subsequent values will define softening or hardening.

<u>VARIABLE</u>	<u>DESCRIPTION</u>
LCFEPS	Load curve ID that defines the plastic failure strain as a function of strain rate.
LCFSIG	Load curve ID that defines the Maximum principal failure stress as a function of strain rate.
LCE	Load curve ID that defines the Unloading moduli as a function of plastic strain.

**Remarks:**

The constitutive model for this approach is:

$$\dot{\varepsilon}_p = \dot{\varepsilon}_0 \exp(A\{\sigma - S(\varepsilon_p)\}) \times \exp(-p\alpha A)$$

where  $\dot{\varepsilon}_0$  and A are rate dependent yield stress parameters,  $S(\varepsilon_p)$  internal resistance (strain hardening) and  $\alpha$  is a pressure dependence parameter.

In this material the yield stress may vary throughout the finite element model as a function of strain rate and hydrostatic stress. Post yield stress behavior is captured in material softening and hardening values. Finally, ductile or brittle failure measured by plastic strain or maximum principal stress respectively is accounted for by automatic element deletion.

Although this may be applied to a variety of engineering thermoplastics, GE Plastics have constants available for use in a wide range of commercially available grades of their engineering thermoplastics.

\*MAT\_INV\_HYPERBOLIC\_SIN

This is Material Type 102. It allows the modeling of temperature and rate dependent plasticity, Sheppard and Wright [1979].

Card 1            1            2            3            4            5            6            7            8

Variable	MID	RO	E	PR	T	HC	VP	
Type	A8	F	F	F	F	F	F	

Card 2            1            2            3            4            5            6            7            8

Variable	ALPHA	N	A	Q	G	EPS0		
Type	F	F	F	F	F	F		

<u>VARIABLE</u>	<u>DESCRIPTION</u>
MID	Material identification. A unique number or label not exceeding 8 characters must be specified.
RO	Mass density.
E	Young's Modulus.
PR	Poisson's ratio
T	Initial Temperature.
HC	Heat generation coefficient.
VP	Formulation for rate effects: EQ.0.0: Scale yield stress (default) EQ.1.0: Viscoplastic formulation.
ALPHA	See Remarks.
N	See Remarks.
A	See Remarks.
Q	See Remarks.

VARIABLE	DESCRIPTION
G	See Remarks.
EPS0	Minimum strain rate considered in calculating Z.

**Remarks:**

Resistance to deformation is both temperature and strain rate dependent. The flow stress equation is:

$$\sigma = \frac{1}{\alpha} \sinh^{-1} \left( \left[ \frac{Z}{A} \right]^{\frac{1}{N}} \right)$$

where Z, the Zener-Holloman temperature compensated strain rate, is:

$$Z = \max(\dot{\epsilon}, EPS0) \exp \left( \frac{Q}{GT} \right)$$

The units of the material constitutive constants are as follows: A (1/sec), N (dimensionless), α (1/MPa), the activation energy for flow, Q (J/mol), and the universal gas constant, G (J/mol K). The value of G will only vary with the unit system chosen. Typically it will be either 8.3144 J/mol ∞ K, or 40.8825 lb in/mol ∞ R.

The final equation necessary to complete our description of high strain rate deformation is one that allows us to compute the temperature change during the deformation. In the absence of a couples thermo-mechanical finite element code we assume adiabatic temperature change and follow the empirical assumption that 90-95% of the plastic work is dissipated as heat. Thus the heat generation coefficient is

$$HC \approx \frac{0.9}{\rho C_v}$$

where ρ is the density of the material and C<sub>v</sub> is the specific heat.

\*MAT\_ANISOTROPIC\_VISCOPLASTIC

This is Material Type 103. This anisotropic-viscoplastic material model applies to shell and brick elements. The material constants may be fit directly or, if desired, stress versus strain data may be input and a least squares fit will be performed by LS-DYNA to determine the constants. Kinematic or isotropic or a combination of kinematic and isotropic hardening may be used. A detailed description of this model can be found in the following references: Berstad, Langseth, and Hopperstad [1994]; Hopperstad and Remseth [1995]; and Berstad [1996]. Failure is based on effective plastic strain or by a user defined subroutine.

Card 1            1            2            3            4            5            6            7            8

Variable	MID	RO	E	PR	SIGY	FLAG	LCSS	ALPHA
Type	A8	F	F	F	F	F	F	F

Card 2            1            2            3            4            5            6            7            8

Variable	QR1	CR1	QR2	CR2	QX1	CX1	QX2	CX2
Type	F	F	F	F	F	F	F	F

Card 3            1            2            3            4            5            6            7            8

Variable	VK	VM	R00 or F	R45 or G	R90 or H	L	M	N
Type	F	F	F	F	F	F	F	F

Card 4            1            2            3            4            5            6            7            8

Variable	AOPT	FAIL	NUMINT	MACF				
Type	F	F	F	I				

Card 5            1            2            3            4            5            6            7            8

Variable	XP	YP	ZP	A1	A2	A3		
Type	F	F	F	F	F	F		

Card 6            1            2            3            4            5            6            7            8

Variable	V1	V2	V3	D1	D2	D3	BETA	
Type	F	F	F	F	F	F	F	

<u>VARIABLE</u>	<u>DESCRIPTION</u>
MID	Material identification. A unique number or label not exceeding 8 characters must be specified.
RO	Mass density.
E	Young's modulus
PR	Poisson's ratio
SIGY	Initial yield stress
FLAG	Flag EQ.0: Give all material parameters EQ.1: Material parameters are fit in LS-DYNA to Load curve or Table given below. The parameters $Q_{r1}$ , $C_{r1}$ , $Q_{r2}$ , and $C_{r2}$ for isotropic hardening are determined by the fit and those for kinematic hardening are found by scaling those for isotropic hardening by $(1-\alpha)$ where $\alpha$ is defined below in columns 51-60. EQ.2: Use load curve directly, i.e., no fitting is required for the parameters $Q_{r1}$ , $C_{r1}$ , $Q_{r2}$ , and $C_{r2}$ . A table is not allowed.

VARIABLE	DESCRIPTION
LCSS	Load curve ID or Table ID. The load curve ID defines effective stress versus effective plastic strain. Card 2 is ignored with this option. The table ID, see Figure 24.1, defines for each strain rate value a load curve ID giving the stress versus effective plastic strain for that rate. If the load curve only is used, then the coefficients $V_k$ and $V_m$ must be given if viscoplastic behavior is desired. If a Table ID is given these coefficients are determined internally during initialization.
ALPHA	$\alpha$ distribution of hardening used in the curve-fitting. $\alpha = 0$ pure kinematic hardening and $\alpha = 1$ provides pure isotropic hardening
QR1	Isotropic hardening parameter $Q_{r1}$
CR1	Isotropic hardening parameter $C_{r1}$
QR2	Isotropic hardening parameter $Q_{r2}$
CR2	Isotropic hardening parameter $C_{r2}$
QX1	Kinematic hardening parameter $Q_{\chi1}$
CX1	Kinematic hardening parameter $C_{\chi1}$
QX2	Kinematic hardening parameter $Q_{\chi2}$
CX2	Kinematic hardening parameter $C_{\chi2}$
VK	Viscous material parameter $V_k$
VM	Viscous material parameter $V_m$
R00	$R_{00}$ for shell (Default=1.0)
R45	$R_{45}$ for shell (Default=1.0)
R90	$R_{90}$ for shell (Default=1.0)
F	$F$ for brick (Default =1/2)
G	$G$ for brick (Default =1/2)
H	$H$ for brick (Default =1/2)

<u>VARIABLE</u>	<u>DESCRIPTION</u>
L	<i>L</i> for brick (Default =3/2)
M	<i>M</i> for brick (Default =3/2)
N	<i>N</i> for brick (Default =3/2)
AOPT	Material axes option (see <i>MAT_OPTION TROPIC_ELASTIC</i> for a more complete description): EQ.0.0: locally orthotropic with material axes determined by element nodes 1, 2, and 4, as with <i>*DEFINE_COORDINATE_NODES</i> , and then, for shells only, rotated about the shell element normal by an angle BETA. EQ.1.0: locally orthotropic with material axes determined by a point in space and the global location of the element center; this is the <i>a</i> -direction. This option is for solid elements only. EQ.2.0: globally orthotropic with material axes determined by vectors defined below, as with <i>*DEFINE_COORDINATE_VECTOR</i> . EQ.3.0: locally orthotropic material axes determined by rotating the material axes about the element normal by an angle, BETA, from a line in the plane of the element defined by the cross product of the vector <i>v</i> with the element normal. EQ.4.0: locally orthotropic in cylindrical coordinate system with the material axes determined by a vector <i>v</i> , and an originating point, P, which define the centerline axis. This option is for solid elements only. LT.0.0: the absolute value of AOPT is a coordinate system ID number (CID on <i>*DEFINE_COORDINATE_NODES</i> , <i>*DEFINE_COORDINATE_SYSTEM</i> or <i>*DEFINE_COORDINATE_VECTOR</i> ). Available in R3 version of 971 and later.
FAIL	Failure flag. LT.0.0: User defined failure subroutine is called to determine failure. This is subroutine named, <i>MATUSR_103</i> , in <i>DYN21.F</i> . EQ.0.0: Failure is not considered. This option is recommended if failure is not of interest since many calculations will be saved. GT.0.0: Plastic strain to failure. When the plastic strain reaches this value, the element is deleted from the calculation.



VARIABLE	DESCRIPTION
NUMINT	Number of integration points which must fail before element deletion. If zero, all points must fail. This option applies to shell elements only. For the case of one point shells, NUMINT should be set to a value that is less than the number of through thickness integration points. Nonphysical stretching can sometimes appear in the results if all integration points have failed except for one point away from the midsurface. This is due to the fact that unconstrained nodal rotations will prevent strains from developing at the remaining integration point. In fully integrated shells, similar problems can occur.
MACF	Material axes change flag for brick elements: EQ.1: No change, default, EQ.2: switch material axes a and b, EQ.3: switch material axes a and c, EQ.4: switch material axes b and c.
XP,YP,ZP	$x_p y_p z_p$ , define coordinates of point <b>p</b> for AOPT = 1 and 4.
A1,A2,A3	$a_1 a_2 a_3$ , define components of vector <b>a</b> for AOPT = 2.
V1,V2,V3	$v_1 v_2 v_3$ , define components of vector <b>v</b> for AOPT = 3 and 4.
D1,D2,D3	$d_1 d_2 d_3$ , define components of vector <b>d</b> for AOPT = 2.
BETA	Material angle in degrees for AOPT=0 (shells only) and AOPT=3. BETA may be overridden on the element card, see *ELEMENT_SHELL_BETA and *ELEMENT_SOLID_ORTHO.

### Remarks:

The uniaxial stress-strain curve is given on the following form

$$\begin{aligned} \sigma(\varepsilon_{eff}^p, \dot{\varepsilon}_{eff}^p) = & \sigma_0 + Q_{r1}(1 - \exp(-C_{r1}\varepsilon_{eff}^p)) + Q_{r2}(1 - \exp(-C_{r2}\varepsilon_{eff}^p)) \\ & + Q_{\chi1}(1 - \exp(-C_{\chi1}\varepsilon_{eff}^p)) + Q_{\chi2}(1 - \exp(-C_{\chi2}\varepsilon_{eff}^p)) \\ & + V_k \dot{\varepsilon}_{eff}^p V_m \end{aligned}$$

For bricks the following yield criteria is used

$$\begin{aligned} F(\sigma_{22} - \sigma_{33})^2 + G(\sigma_{33} - \sigma_{11})^2 + H(\sigma_{11} - \sigma_{22})^2 \\ + 2L\sigma_{23}^2 + 2M\sigma_{31}^2 + 2N\sigma_{12}^2 = \left( \sigma(\varepsilon_{eff}^p, \dot{\varepsilon}_{eff}^p) \right)^2 \end{aligned}$$

where  $\varepsilon_{eff}^p$  is the effective plastic strain and  $\dot{\varepsilon}_{eff}^p$  is the effective plastic strain rate. For shells the anisotropic behavior is given by  $R_{00}$ ,  $R_{45}$  and  $R_{90}$ . The model will work when the three first parameters in card 3 are given values. When  $V_k = 0$  the material will behave elasto-plastically. Default values are given by:

$$F = G = H = \frac{1}{2}$$

$$L = M = N = \frac{3}{2}$$

$$R_{00} = R_{45} = R_{90} = 1$$

Strain rate of accounted for using the Cowper and Symonds model which, e.g., model 3, scales the yield stress with the factor:

$$1 + \left( \frac{\dot{\varepsilon}_{eff}^p}{C} \right)^{1/p}$$

To convert these constants set the viscoelastic constants,  $V_k$  and  $V_m$ , to the following values:

$$V_k = \sigma \left( \frac{1}{C} \right)^{1/p}$$

$$V_m = \frac{1}{p}$$

This model properly treats rate effects. The viscoplastic rate formulation is an option in other plasticity models in LS-DYNA, e.g., mat\_3 and mat\_24, invoked by setting the parameter VP to 1.

\*MAT\_ANISOTROPIC\_PLASTIC

This is Material Type 103\_P. This anisotropic-plastic material model is a simplified version of the MAT\_ANISOTROPIC\_VISCOPLASTIC above. This material model applies only to shell elements.

Card 1            1            2            3            4            5            6            7            8

Variable	MID	RO	E	PR	SIGY	LCSS		
Type	A8	F	F	F	F	F		

Card 2            1            2            3            4            5            6            7            8

Variable	QR1	CR1	QR2	CR2				
Type	F	F	F	F				

Card 3            1            2            3            4            5            6            7            8

Variable	R00	R45	R90	S11	S22	S33	S12	
Type	F	F	F	F	F	F	F	

Card 4            1            2            3            4            5            6            7            8

Variable	AOPT							
Type	F							

Card 5            1            2            3            4            5            6            7            8

Variable	XP	YP	ZP	A1	A2	A3		
Type	F	F	F	F	F	F		

Card 6            1            2            3            4            5            6            7            8

Variable	V1	V2	V3	D1	D2	D3	BETA	
Type	F	F	F	F	F	F	F	

<u>VARIABLE</u>	<u>DESCRIPTION</u>
MID	Material identification. A unique number or label not exceeding 8 characters must be specified.
RO	Mass density.
E	Young's modulus
PR	Poisson's ratio
SIGY	Initial yield stress
LCSS	Load curve ID. The load curve ID defines effective stress versus effective plastic strain. Card 2 is ignored with this option.
QR1	Isotropic hardening parameter $Q_{r1}$
CR1	Isotropic hardening parameter $C_{r1}$
QR2	Isotropic hardening parameter $Q_{r2}$
CR2	Isotropic hardening parameter $C_{r2}$
R00	$R_{00}$ for anisotropic hardening
R45	$R_{45}$ for anisotropic hardening
R90	$R_{90}$ for anisotropic hardening

VARIABLE	DESCRIPTION
S11	Yield stress in local x-direction. This input is ignored if $(R_{00}, R_{45}, R_{90}) > 0$ .
S22	Yield stress in local y-direction. This input is ignored if $(R_{00}, R_{45}, R_{90}) > 0$ .
S33	Yield stress in local z-direction. This input is ignored if $(R_{00}, R_{45}, R_{90}) > 0$ .
S12	Yield stress in local xy-direction. This input is ignored if $(R_{00}, R_{45}, R_{90}) > 0$ .
AOPT	Material axes option (see MAT_OPTION TROPIC_ELASTIC for a more complete description): EQ.0.0: locally orthotropic with material axes determined by element nodes 1, 2, and 4, as with *DEFINE_COORDINATE_NODES, and then rotated about the shell element normal by an angle BETA. EQ.2.0: globally orthotropic with material axes determined by vectors defined below, as with *DEFINE_COORDINATE_VECTOR. EQ.3.0: locally orthotropic material axes determined by rotating the material axes about the element normal by an angle, BETA, from a line in the plane of the element defined by the cross product of the vector <b>v</b> with the element normal. LT.0.0: the absolute value of AOPT is a coordinate system ID number (CID on *DEFINE_COORDINATE_NODES, *DEFINE_COORDINATE_SYSTEM or *DEFINE_COORDINATE_VECTOR). Available in R3 version of 971 and later.
XP,YP,ZP	$x_p$ $y_p$ $z_p$ , define coordinates of point <b>p</b> for AOPT = 1 and 4.
A1,A2,A3	$a_1$ $a_2$ $a_3$ , define components of vector <b>a</b> for AOPT = 2.
D1,D2,D3	$d_1$ $d_2$ $d_3$ , define components of vector <b>d</b> for AOPT = 2.
V1,V2,V3	$v_1$ $v_2$ $v_3$ , define components of vector <b>v</b> for AOPT = 3 and 4.
BETA	Material angle in degrees for AOPT = 0 and 3, may be overridden on the element card, see *ELEMENT_SHELL_BETA.

**Remarks:**

If no load curve is defined for the effective stress versus effective plastic strain, the uniaxial stress-strain curve is given on the following form

$$\sigma(\varepsilon_{eff}^p) = \sigma_0 + Q_{r1}(1 - \exp(-C_{r1}\varepsilon_{eff}^p)) + Q_{r2}(1 - \exp(-C_{r2}\varepsilon_{eff}^p))$$

where  $\varepsilon_{eff}^p$  is the effective plastic strain. For shells the anisotropic behavior is given by  $R_{00}$ ,  $R_{45}$  and  $R_{90}$ , or the yield stress in the different direction. Default values are given by:

$$R_{00} = R_{45} = R_{90} = 1$$

if the variables R00, R45, R90, S11, S22, S33 and S12 are set to zero.

\*MAT\_DAMAGE\_1

This is Material Type 104. This is a continuum damage mechanics (CDM) model which includes anisotropy and viscoplasticity. The CDM model applies to shell, thick shell, and brick elements. A more detailed description of this model can be found in the paper by Berstad, Hopperstad, Lademo, and Malo [1999]. This material model can also model anisotropic damage behavior by setting the FLAG to -1 in Card 2.

Card 1            1            2            3            4            5            6            7            8

Variable	MID	RO	E	PR	SIGY	LCSS	LCDS	
Type	A8	F	F	F	F			

Card 2            1            2            3            4            5            6            7            8

Variable	Q1	C1	Q2	C2	EPSD	S or EPSR	DC	FLAG
Type	F	F	F	F	F	F	F	F

Card 3            1            2            3            4            5            6            7            8

Variable	VK	VM	R00 or F	R45 or G	R90 or H	L	M	N
Type	F	F	F	F	F	F	F	F

Card 4            1            2            3            4            5            6            7            8

Variable	AOPT			MACF				
Type	F			I				

Card 5            1            2            3            4            5            6            7            8

Variable	XP	YP	ZP	A1	A2	A3		
Type	F	F	F	F	F	F		

Card 6            1            2            3            4            5            6            7            8

Variable	V1	V2	V3	D1	D2	D3	BETA	
Type	F	F	F	F	F	F	F	

<u>VARIABLE</u>	<u>DESCRIPTION</u>
MID	Material identification. A unique number or label not exceeding 8 characters must be specified.
RO	Mass density.
E	Young's modulus
PR	Poisson's ratio
SIGY	Initial yield stress, $\sigma_0$ .
LCSS	Load curve ID. Load curve ID defining effective stress versus effective plastic strain. For FLAG = -1.
LCDS	Load curve ID defining nonlinear damage curve. For FLAG = -1.
Q1	Isotropic hardening parameter $Q_1$
C1	Isotropic hardening parameter $C_1$
Q2	Isotropic hardening parameter $Q_2$
C2	Isotropic hardening parameter $C_2$
EPSD	Damage threshold $r_d$ Damage effective plastic strain when material softening begins. (Default=0.0)



VARIABLE	DESCRIPTION
S	Damage material constant $S$ . (Default= $\frac{\sigma_0}{200}$ ). For FLAG $\geq 0$ .
EPSR	Plastic strain at which material ruptures (logarithmic).
DC	Critical damage value $D_c$ . When the damage value $D$ reaches this value, the element is deleted from the calculation. (Default=0.5) For FLAG $\geq 0$ .
FLAG	Flag EQ.-1: Anisotropic damage EQ.0: No calculation of localization due to damage EQ.1: The model flags element where strain localization occur
VK	Viscous material parameter $V_k$
VM	Viscous material parameter $V_m$
R00	$R_{00}$ for shell (Default=1.0)
R45	$R_{45}$ for shell (Default=1.0)
R90	$R_{90}$ for shell (Default=1.0)
F	$F$ for brick (Default =1/2)
G	$G$ for brick (Default =1/2)
H	$H$ for brick (Default =1/2)
L	$L$ for brick (Default =3/2)
M	$M$ for brick (Default =3/2)
N	$N$ for brick (Default =3/2)

VARIABLE	DESCRIPTION
AOPT	<p>Material axes option (see MAT_OPTION TROPIC_ELASTIC for a more complete description):</p> <p>EQ.0.0: locally orthotropic with material axes determined by element nodes 1, 2, and 4, as with *DEFINE_COORDINATE_NODES, and then, for shells only, rotated about the shell element normal by an angle BETA.</p> <p>EQ.1.0: locally orthotropic with material axes determined by a point in space and the global location of the element center; this is the a-direction. This option is for solid elements only.</p> <p>EQ.2.0: globally orthotropic with material axes determined by vectors defined below, as with *DEFINE_COORDINATE_VECTOR.</p> <p>EQ.3.0: locally orthotropic material axes determined by rotating the material axes about the element normal by an angle, BETA, from a line in the plane of the element defined by the cross product of the vector <b>v</b> with the element normal.</p> <p>EQ.4.0: locally orthotropic in cylindrical coordinate system with the material axes determined by a vector <b>v</b>, and an originating point, <b>P</b>, which define the centerline axis. This option is for solid elements only.</p> <p>LT.0.0: the absolute value of AOPT is a coordinate system ID number (CID on *DEFINE_COORDINATE_NODES, *DEFINE_COORDINATE_SYSTEM or *DEFINE_COORDINATE_VECTOR). Available in R3 version of 971 and later.</p>
MACF	<p>Material axes change flag for brick elements:</p> <p>EQ.1: No change, default,</p> <p>EQ.2: switch material axes a and b,</p> <p>EQ.3: switch material axes a and c,</p> <p>EQ.4: switch material axes b and c.</p>
XP,YP,ZP	$x_p y_p z_p$ , define coordinates of point <b>p</b> for AOPT = 1 and 4.
A1,A2,A3	$a_1 a_2 a_3$ , define components of vector <b>a</b> for AOPT = 2.
D1,D2,D3	$d_1 d_2 d_3$ , define components of vector <b>d</b> for AOPT = 2.
V1,V2,V3	$v_1 v_2 v_3$ , define components of vector <b>v</b> for AOPT = 3 and 4.
BETA	<p>Material angle in degrees for AOPT=0 (shells only) and AOPT=3. BETA may be overridden on the element card, see *ELEMENT_SHELL_BETA and *ELEMENT_SOLID_ORTHO.</p>

**Remarks:**

Anisotropic Damage model (FLAG = -1). At each thickness integration points, an anisotropic damage law acts on the plane stress tensor in the directions of the principal total shell strains,  $\varepsilon_1$  and  $\varepsilon_2$ , as follows:

$$\begin{aligned}\sigma_{11} &= (1 - D_1(\varepsilon_1))\sigma_{110} \\ \sigma_{22} &= (1 - D_2(\varepsilon_2))\sigma_{220} \\ \sigma_{12} &= (1 - (D_1 + D_2) / 2)\sigma_{120}\end{aligned}$$

The transverse plate shear stresses in the principal strain directions are assumed to be damaged as follows:

$$\begin{aligned}\sigma_{13} &= (1 - D_1 / 2)\sigma_{130} \\ \sigma_{23} &= (1 - D_2 / 2)\sigma_{230}\end{aligned}$$

In the anisotropic damage formulation,  $D_1(\varepsilon_1)$  and  $D_2(\varepsilon_2)$  are anisotropic damage functions for the loading directions 1 and 2, respectively. Stresses  $\sigma_{110}$ ,  $\sigma_{220}$ ,  $\sigma_{120}$ ,  $\sigma_{130}$  and  $\sigma_{230}$  are stresses in the principal shell strain directions as calculated from the undamaged elastic-plastic material behavior. The strains  $\varepsilon_1$  and  $\varepsilon_2$  are the magnitude of the principal strains calculated upon reaching the damage thresholds. Damage can only develop for tensile stresses, and the damage functions  $D_1(\varepsilon_1)$  and  $D_2(\varepsilon_2)$  are identical to zero for negative strains  $\varepsilon_1$  and  $\varepsilon_2$ . The principal strain directions are fixed within an integration point as soon as either principal strain exceeds the initial threshold strain in tension. A more detailed description of the damage evolution for this material model is given in the description of Material 81.

The Continuum Damage Mechanics (CDM) model (FLAG  $\geq 0$ ) is based on a CDM model proposed by Lemaitre [1992]. The effective stress  $\tilde{\sigma}$ , which is the stress calculated over the section that effectively resist the forces and reads.

$$\tilde{\sigma} = \frac{\sigma}{1 - D}$$

where  $D$  is the damage variable. The evolution equation for the damage variable is defined as

$$\dot{D} = \begin{cases} 0 & \text{for } r \leq r_D \\ \frac{Y}{S(1 - D)} \dot{r} & \text{for } r > r_D \text{ and } \sigma_1 > 0 \end{cases}$$

where  $r_D$  is the damage threshold,

is a positive material constant,  $S$  is the so-called strain energy release rate and  $\sigma_1$  is the maximal principal stress. The strain energy density release rate is

$$Y = \frac{1}{2} \mathbf{e}_e : \mathbf{C} : \mathbf{e}_e = \frac{\sigma_{vm}^2 R_v}{2E(1-D)^2}$$

where  $\sigma_{vm}$  is the equivalent von Mises stress. The triaxiality function  $R_v$  is defined as

$$R_v = \frac{2}{3}(1+\nu) + 3(1-2\nu) \left( \frac{\sigma_H}{\sigma_{vm}} \right)^2$$

The uniaxial stress-strain curve is given in the following form

$$\begin{aligned} \sigma(r, \dot{\epsilon}_{eff}^p) = & \sigma_0 + Q_1(1 - \exp(-C_1 r)) + Q_2(1 - \exp(-C_2 r)) \\ & + V_k \dot{\epsilon}_{eff}^p V_m \end{aligned}$$

where  $r$  is the damage accumulated plastic strain, which can be calculated by

$$\dot{r} = \dot{\epsilon}_{eff}^p (1-D)$$

For bricks the following yield criteria is used

$$\begin{aligned} F(\tilde{\sigma}_{22} - \tilde{\sigma}_{33})^2 + G(\tilde{\sigma}_{33} - \tilde{\sigma}_{11})^2 + H(\tilde{\sigma}_{11} - \tilde{\sigma}_{22})^2 \\ + 2L\tilde{\sigma}_{23}^2 + 2M\tilde{\sigma}_{31}^2 + 2N\tilde{\sigma}_{12}^2 = \sigma(r, \dot{\epsilon}_{eff}^p) \end{aligned}$$

where  $r$  is the damage effective viscoplastic strain and  $\dot{\epsilon}_{eff}^p$  is the effective viscoplastic strain rate. For shells the anisotropic behavior is given by the R-values:  $R_{00}$ ,  $R_{45}$ , and  $R_{90}$ . When  $V_k = 0$  the material will behave as an elastoplastic material without rate effects. Default values for the anisotropic constants are given by:

$$F = G = H = \frac{1}{2}$$

$$L = M = N = \frac{3}{2}$$

$$R_{00} = R_{45} = R_{90} = 1$$

so that isotropic behavior is obtained.

Strain rate is accounted for using the Cowper and Symonds model which scales the yield stress with the factor:

$$1 + \left( \frac{\dot{\epsilon}}{C} \right)^{1/p}$$

To convert these constants, set the viscoelastic constants,  $V_k$  and  $V_m$ , to the following values:

$$V_k = \sigma \left( \frac{1}{C} \right)^{\frac{1}{p}}$$

$$V_m = \frac{1}{p}$$



**\*MAT\_DAMAGE\_2**

This is Material Type 105. This is an elastic viscoplastic material model combined with continuum damage mechanics (CDM). This material model applies to shell, thick shell, and brick elements. The elastoplastic behavior is described in the description of material model 24. A more detailed description of the CDM model is given in the description of material model 104 above.

Card 1            1            2            3            4            5            6            7            8

Variable	MID	RO	E	PR	SIGY	ETAN	FAIL	TDEL
Type	A8	F	F	F	F	F	F	F
Default	none	none	none	none	none	0.0	10.E+20	0

Card 2            1            2            3            4            5            6            7            8

Variable	C	P	LCSS	LCSR				
Type	F	F	F	F				
Default	0	0	0	0				

Card 3            1            2            3            4            5            6            7            8

Variable	EPSD	S	DC					
Type	F	F	F					
Default	none	none	none					

Card 4            1            2            3            4            5            6            7            8

Variable	EPS1	EPS2	EPS3	EPS4	EPS5	EPS6	EPS7	EPS8
Type	F	F	\F	F	F	F	F	F
Default	0	0	0	0	0	0	0	0

Card 5            1            2            3            4            5            6            7            8

Variable	ES1	ES2	ES3	ES4	ES5	ES6	ES7	ES8
Type	F	F	F	F	F	F	F	F
Default	0	0	0	0	0	0	0	0

<u>VARIABLE</u>	<u>DESCRIPTION</u>
MID	Material identification. A unique number or label not exceeding 8 characters must be specified.
RO	Mass density.
E	Young's modulus.
PR	Poisson's ratio.
SIGY	Yield stress.
ETAN	Tangent modulus, ignored if (LCSS.GT.0) is defined.
FAIL	Failure flag. EQ.0.0: Failure due to plastic strain is not considered. GT.0.0: Plastic strain to failure. When the plastic strain reaches this value, the element is deleted from the calculation.
TDEL	Minimum time step size for automatic element deletion.
C	Strain rate parameter, C, see formula below.
P	Strain rate parameter, P, see formula below.

VARIABLE	DESCRIPTION
LCSS	Load curve ID or Table ID. Load curve ID defining effective stress versus effective plastic strain. If defined EPS1-EPS8 and ES1-ES8 are ignored. The table ID defines for each strain rate value a load curve ID giving the stress versus effective plastic strain for that rate, See Figure 24.1. The stress versus effective plastic strain curve for the lowest value of strain rate is used if the strain rate falls below the minimum value. Likewise, the stress versus effective plastic strain curve for the highest value of strain rate is used if the strain rate exceeds the maximum value. The strain rate parameters: C and P; the curve ID, LCSR; EPS1-EPS8 and ES1-ES8 are ignored if a Table ID is defined.
LCSR	Load curve ID defining strain rate scaling effect on yield stress.
EPSD	Damage threshold $r_d$ Damage effective plastic strain when material softening begin. (Default=0.0)
S	Damage material constant $S$ . $\left( \text{Default} = \frac{\sigma_0}{200} \right)$
DC	Critical damage value $D_c$ . When the damage value $D$ reaches this value, the element is deleted from the calculation. (Default=0.5)
EPS1-EPS8	Effective plastic strain values (optional if SIGY is defined). At least 2 points should be defined.
ES1-ES8	Corresponding yield stress values to EPS1 - EPS8.

### **Remarks:**

The stress-strain behavior may be treated by a bilinear curve by defining the tangent modulus, ETAN. Alternately, a curve similar to that shown in Figure 10.1 is expected to be defined by (EPS1,ES1) - (EPS8,ES8); however, an effective stress versus effective plastic strain curve ID (LCSS) may be input instead if eight points are insufficient. The cost is roughly the same for either approach. The most general approach is to use the table definition with table ID, LCSR, discussed below.

Three options to account for strain rate effects are possible.

- I. Strain rate may be accounted for using the Cowper and Symonds model which scales the yield stress with the factor

$$1 + \left( \frac{\dot{\epsilon}}{C} \right)^{1/p}$$



where  $\dot{\epsilon}$  is the strain rate,  $\dot{\epsilon} = \sqrt{\dot{\epsilon}_{ij} \dot{\epsilon}_{ij}}$

- II. For complete generality a load curve (LCSR) to scale the yield stress may be input instead. In this curve the scale factor versus strain rate is defined.
- III. If different stress versus strain curves can be provided for various strain rates, the option using the reference to a table (LCSS) can be used. Then the table input in \*DEFINE\_TABLE has to be used, see Figure 24.1.

A fully viscoplastic formulation is used in this model.

# \*MAT 106

# \*MAT\_ELASTIC\_VISCOPLASTIC\_THERMAL

## \*MAT\_ELASTIC\_VISCOPLASTIC\_THERMAL

This is Material Type 106. This is an elastic viscoplastic material with thermal effects.

Card 1            1            2            3            4            5            6            7            8

Variable	MID	RO	E	PR	SIGY	ALPHA	LCSS	
Type	A8	F	F	F	F	F	F	

Card 2            1            2            3            4            5            6            7            8

Variable	QR1	CR1	QR2	CR2	QX1	CX1	QX2	CX2
Type	F	F	F	F	F	F	F	F

Card 3            1            2            3            4            5            6            7            8

Variable	C	P	LCE	LCPR	LCSIGY	LCR	LCX	LCALPH
Type	F	F	F	F	F	F	F	F

Card 4            1            2            3            4            5            6            7            8

Variable	LCC	LCP	TREF					
Type	F	F	F					

<u>VARIABLE</u>	<u>DESCRIPTION</u>
MID	Material identification. A unique number or label not exceeding 8 characters must be specified.
RO	Mass density.

VARIABLE	DESCRIPTION
E	Young's modulus
PR	Poisson's ratio
SIGY	Initial yield stress
LCSS	Load curve ID or Table ID. The load curve ID defines effective stress versus effective plastic strain. The table ID defines for each temperature value a load curve ID giving the stress versus effective plastic strain for that temperature (DEFINE_TABLE) or it defines for each temperature value a table ID which defines for each strain rate a load curve ID giving the stress versus effective plastic strain (DEFINE_TABLE_3D). The stress versus effective plastic strain curve for the lowest value of temperature or strain rate is used if the temperature or strain rate falls below the minimum value. Likewise, maximum values cannot be exceeded. Card 2 is ignored with this option.
ALPHA	Coefficient of thermal expansion.
QR1	Isotropic hardening parameter $Q_{r1}$
CR1	Isotropic hardening parameter $C_{r1}$
QR2	Isotropic hardening parameter $Q_{r2}$
CR2	Isotropic hardening parameter $C_{r2}$
QX1	Kinematic hardening parameter $Q_{\chi1}$
CX1	Kinematic hardening parameter $C_{\chi1}$
QX2	Kinematic hardening parameter $Q_{\chi2}$
CX2	Kinematic hardening parameter $C_{\chi2}$
C	Viscous material parameter $C$
P	Viscous material parameter $P$
LCE	Load curve defining Young's modulus as a function of temperature. E on card 1 is ignored with this option.
LCPR	Load curve defining Poisson's ratio as a function of temperature. PR on card 1 is ignored with this option.

VARIABLE	DESCRIPTION
LCSIGY	Load curve defining the initial yield stress as a function of temperature. SIGY on card 1 is ignored with this option.
LCR	Load curve for scaling the isotropic hardening parameters QR1 and QR2 or the stress given by the load curve LCSS as a function of temperature.
LCX	Load curve for scaling the kinematic hardening parameters QX1 and QX2 as a function of temperature.
LCALPH	<p>Load curve ID defining the instantaneous coefficient of thermal expansion as a function of temperature:</p> $d\varepsilon_{ij}^{thermal} = \alpha(T)dT\delta_{ij}$ <p>ALPHA on card 1 is ignored with this option. If LCALPH is defined as the negative of the load curve ID, the curve is assumed to define the coefficient relative to a reference temperature, TREF below, such that the total thermal strain is give by</p> $\varepsilon_{ij}^{thermal} = \alpha(T)(T - T_{ref})\delta_{ij}$
LCC	Load curve for scaling the viscous material parameter C as a function of temperature.
LCP	Load curve for scaling the viscous material parameter P as a function of temperature.
TREF	Reference temperature required if and only if LCALPH is given with a negative curve ID.

**Remarks:**

If LCSS is not given any value the uniaxial stress-strain curve has the form

$$\sigma(\varepsilon_{eff}^p) = \sigma_0 + Q_{r1}(1 - \exp(-C_{r1}\varepsilon_{eff}^p)) + Q_{r2}(1 - \exp(-C_{r2}\varepsilon_{eff}^p)) + Q_{\chi1}(1 - \exp(-C_{\chi1}\varepsilon_{eff}^p)) + Q_{\chi2}(1 - \exp(-C_{\chi2}\varepsilon_{eff}^p))$$

Viscous effects are accounted for using the Cowper and Symonds model, which scales the yield stress with the factor:

$$1 + \left( \frac{\dot{\varepsilon}_{eff}^p}{C} \right)^{1/p}$$

\*MAT\_MODIFIED\_JOHNSON\_COOK

This is Material Type 107.

Define the following two cards with general material parameters

Card 1            1            2            3            4            5            6            7            8

Variable	MID	RO	E	PR	BETA	XS1	CP	ALPHA
Type	A8	F	F	F	F	F	F	F

Card 2            1            2            3            4            5            6            7            8

Variable	E0DOT	Tr	Tm	T0	FLAG1	FLAG2		
Type	F	F	F	F	F	F		

Card 3 is the modified Johnson-Cook constitutive relation (FLAG1=0)  
Define the following two cards if and only if FLAG1=0.

Card 3            1            2            3            4            5            6            7            8

Variable	A	B	N	C	m			
Type	F	F	F	F	F			

Card 4 is the modified Johnson-Cook constitutive relation with Voce hardening (FLAG=0)

Card 4            1            2            3            4            5            6            7            8

Variable	Q1	C1	Q2	C2				
Type	F	F	F	F				

**Card 3 is the Zerilli-Armstrong constitutive relation (FLAG1=1)  
Define the following two cards if and only if FLAG1=1:**

Card 3            1            2            3            4            5            6            7            8

Variable	SIGA	B	BETA0	BETA1				
Type	F	F	F	F				

**Card 4 is the Zerilli-Armstrong constitutive relation (FLAG1=1)**

Card 4            1            2            3            4            5            6            7            8

Variable	A	N	ALPHA0	ALPHA1				
Type	F	F	F	F				

**Define the following card if and only if FLAG2=0:  
Card 5 is the modified Johnson-Cook fracture criterion (FLAG2=0)**

Card 5            1            2            3            4            5            6            7            8

Variable	DC	PD	D1	D2	D3	D4	D5	
Type	F	F	F	F	F	F	F	

**Define the following card if and only if FLAG2=1  
Card 5 is the Cockcroft-Latham fracture criterion (FLAG2=1)**

Card 5            1            2            3            4            5            6            7            8

Variable	DC	WC						
Type	F	F						

Card 6 includes additional element erosion criteria

Card 6            1            2            3            4            5            6            7            8

Variable	TC	TAUC						
Type	F	F						

VARIABLE	DESCRIPTION
MID	Material identification. A unique number or label not exceeding 8 characters must be specified.
RO	Mass density
E	Young's modulus, E.
PR	Poisson's ratio, $\nu$ .
BETA	Damage coupling parameter; see Eq. (107.3). EQ.0.0: No coupling between ductile damage and the constitutive relation. EQ.1.0: Full coupling between ductile damage and the constitutive relation.
XS1	Taylor-Quinney coefficient $\chi$ , see Eq. (107.20). Gives the portion of plastic work converted into heat (normally taken to be 0.9)
CP	Specific heat $C_p$ , see Eq. (107.20)
ALPHA	Thermal expansion coefficient, $\alpha$ .
EPS0	Quasi-static threshold strain rate ( $\dot{\epsilon}_0 = \dot{p}_0 = \dot{r}_0$ ), see Eq. (107.12). Set description under *MAT_015.
Tr	Room temperature, see Eq. (107.13)
Tm	Melt temperature, see Eq. (107.13)
T0	Initial temperature
FLAG1	Constitutive relation flag; see Eq. (107.11) and (107.14) EQ.0.0: Modified Johnson-Cook constitutive relation, see Eq. (107.11). EQ.1.0: Zerilli-Armstrong constitutive relation, see Eq. (107.14).

<b>VARIABLE</b>	<b>DESCRIPTION</b>
FLAG2	Fracture criterion flag; see Eq. (107.15) and (107.19). EQ.0.0: Modified Johnson-Cook fracture criterion; see Eq. (107.15). EQ.1.0: Cockcroft-Latham fracture criterion; see Eq. (107.19).
K	Bulk modulus
G	Shear modulus
A	Johnson-Cook yield stress A, see Eq. (107.11).
B	Johnson-Cook hardening parameter B, see Eq. (107.11).
N	Johnson-Cook hardening parameter n, see Eq. (107.11).
C	Johnson-Cook strain rate sensitivity parameter C, see Eq. (107.11).
M	Johnson-Cook thermal softening parameter m, see Eq. (107.11).
Q1	Voce hardening parameter $Q_1$ (when $B = n = 0$ ), see Eq. (107.11).
C1	Voce hardening parameter $C_1$ (when $B = n = 0$ ), see Eq. (107.11).
Q2	Voce hardening parameter $Q_2$ (when $B = n = 0$ ), see Eq. (107.11).
C2	Voce hardening parameter $C_2$ (when $B = n = 0$ ), see Eq. (107.11).
SIGA	Zerilli-Armstrong parameter $\alpha_a$ , see Eq. (107.14).
B	Zerilli-Armstrong parameter $B$ , see Eq. (107.14).
BETA0	Zerilli-Armstrong parameter $\beta_0$ , see Eq. (107.14).
BETA1	Zerilli-Armstrong parameter $\beta_1$ , see Eq. (107.14).
A	Zerilli-Armstrong parameter $A$ , see Eq. (107.14).
N	Zerilli-Armstrong parameter $n$ , see Eq. (107.14).
ALPHA0	Zerilli-Armstrong parameter $\alpha_0$ , see Eq. (107.14).
ALPHA1	Zerilli-Armstrong parameter $\alpha_1$ , see Eq. (107.14).
DC	Critical damage parameter $D_c$ , see Eq. (107.15) and (107.21). When the damage value $D$ reaches this value, the element is eroded from the calculation.



VARIABLE	DESCRIPTION
PD	Damage threshold, see Eq. (107.15).
D1-D5	Fracture parameters in the Johnson-Cook fracture criterion, see Eq. (107.16).
WC	Critical Cockcroft-Latham parameter $W_c$ , see Eq. (107.19). When the plastic work per volume reaches this value, the element is eroded from the simulation.
TC	Critical temperature parameter $T_c$ , see Eq. (107.23). When the temperature $T$ , reaches this value, the element is eroded from the simulation.
TAUC	Critical shear stress parameter $\tau_c$ . When the maximum shear stress $\tau$ reaches this value, the element is eroded from the simulation.

### Remarks:

An additive decomposition of the rate-of-deformation tensor  $\mathbf{d}$  is assumed, i.e.

$$\mathbf{d} = \mathbf{d}^e + \mathbf{d}^p + \mathbf{d}^t \quad (107.1)$$

Where  $\mathbf{d}^e$  is the elastic part,  $\mathbf{d}^p$  is the plastic part and  $\mathbf{d}^t$  is the thermal part.

The elastic rate-of-deformation  $\mathbf{d}^e$  is defined by a linear hypo-elastic relation

$$\tilde{\boldsymbol{\sigma}}^{\nabla J} = \left( K - \frac{2}{3}G \right) tr(\mathbf{d}^e) \mathbf{I} + 2G\mathbf{d}^e \quad (107.2)$$

Where  $\mathbf{I}$  is the unit tensor,  $K$  is the bulk modulus and  $G$  is the shear modulus. The effective stress tensor is defined by

$$\tilde{\boldsymbol{\sigma}} = \frac{\boldsymbol{\sigma}}{1 - \beta D} \quad (107.3)$$

Where  $\boldsymbol{\sigma}$  is the Cauchy-stress and  $D$  is the damage variable, while the Jaumann rate of the effective stress reads

$$\tilde{\boldsymbol{\sigma}}^{\nabla J} = \dot{\tilde{\boldsymbol{\sigma}}} - \mathbf{W} \cdot \tilde{\boldsymbol{\sigma}} - \tilde{\boldsymbol{\sigma}} \cdot \mathbf{W}^T \quad (107.4)$$

Where  $\mathbf{W}$  is the spin tensor. The parameter  $\beta$  is equal to unity for coupled damage and equal to zero for uncoupled damage.

The thermal rate-of-deformation  $\mathbf{d}^T$  is defined by

$$\mathbf{d}^T = \alpha \dot{T} \mathbf{I} \quad (107.5)$$

Where  $\alpha$  is the linear thermal expansion coefficient and  $T$  is the temperature.

The plastic rate-of-deformation is defined by the associated flow rule as

$$\mathbf{d}^p = \dot{r} \frac{\partial f}{\partial \boldsymbol{\sigma}} = \frac{3}{2} \frac{\dot{r}}{1 - \beta D} \frac{\tilde{\boldsymbol{\sigma}}'}{\tilde{\sigma}_{eq}} \quad (107.6)$$

Where  $(\cdot)'$  means the deviatoric part of the tensor,  $r$  is the damage-equivalent plastic strain,  $f$  is the dynamic yield function, i.e.

$$f = \sqrt{\frac{3}{2} \tilde{\boldsymbol{\sigma}}' : \tilde{\boldsymbol{\sigma}}'} - \sigma_Y(r, \dot{r}, T) \leq 0, \quad \dot{r} \geq 0, \quad \dot{r} f = 0 \quad (107.7)$$

And  $\tilde{\sigma}_{eq}$  is the damage-equivalent stress.

$$\tilde{\sigma}_{eq} = \sqrt{\frac{3}{2} \tilde{\boldsymbol{\sigma}}' : \tilde{\boldsymbol{\sigma}}'} \quad (107.8)$$

The following plastic work conjugate pairs are identified

$$\dot{W}^p = \boldsymbol{\sigma} : \mathbf{d}^p = \tilde{\sigma}_{eq} \dot{r} = \sigma_{eq} \dot{p} \quad (107.9)$$

Where  $\dot{W}^p$  is the specific plastic work rate, and the equivalent stress  $\sigma_{eq}$  and the equivalent plastic strain  $p$  are defined as

$$\sigma_{eq} = \sqrt{\frac{3}{2} \tilde{\boldsymbol{\sigma}}' : \tilde{\boldsymbol{\sigma}}'} = (1 - \beta D) \tilde{\sigma}_{eq}, \quad \dot{p} = \sqrt{\frac{2}{3} \mathbf{d}^p : \mathbf{d}^p} = \frac{\dot{r}}{(1 - \beta D)} \quad (107.10)$$

The material strength  $\sigma_Y$  is defined by

1. The modified Johnson-Cook constitutive relation

$$\sigma_Y = \left( A + B r^n = \sum_{i=1}^2 Q_i (1 - \exp(-C_i r)) \right) (1 + \dot{r}^*)^C (1 - T^m) \quad (107.11)$$

Where  $A, B, C, m, n, Q_1, C_1, Q_2, C_2$  are material parameters; the normalized damage-equivalent plastic strain rate  $\dot{r}^*$  is defined by

$$\dot{\epsilon}^* = \frac{\dot{\epsilon}}{\dot{\epsilon}_0} \quad (107.12)$$

In which  $\dot{\epsilon}_0$  is a user-defined reference strain rate; and the homologous temperature reads

$$T^* = \frac{T - T_r}{T_m - T_r} \quad (107.13)$$

In which  $T_r$  is the room temperature (or initial temperature) and  $T_m$  is the melting temperature.

## 2. The Zerilli-Armstrong constitutive relation

$$\sigma_Y = \left[ \sigma_a + B \exp(-(\beta_0 - \beta_1 \ln \dot{\epsilon})T) + A r^n \exp(-(\alpha_0 - \alpha_1 \ln \dot{\epsilon})T) \right] \quad (107.14)$$

Where  $\sigma_a, B, \beta_0, \beta_1, A, n, \alpha_0, \alpha_1$  are material parameters.

Damage evolution is defined by:

### 1. The extended Johnson-Cook damage evolution rule:

$$\dot{D} = \begin{cases} 0 & \text{for } p \leq p_d \\ \frac{D_C}{p_f - p_d} \dot{p} & \text{for } p > p_d \end{cases} \quad (107.15)$$

Where the current equivalent fracture strain  $p_f = p_f(\sigma^*, \dot{p}^*, T^*)$  is defined as

$$p_f = (D_1 + D_2 \exp(-D_3 \sigma^*)) (1 + \dot{p}^*)^{D_4} (1 + D_5 T^*) \quad (107.16)$$

And  $D_1, D_2, D_3, D_4, D_5, D_C, p_d$  are material parameters; the normalized equivalent plastic strain rate  $\dot{p}^*$  is defined by

$$\dot{p}^* = \frac{\dot{p}}{\dot{\epsilon}_0} \quad (107.17)$$

And the stress triaxiality  $\sigma^*$  reads

$$\sigma^* = \frac{\sigma_H}{\sigma_{eq}}, \quad \sigma_H = \frac{1}{3} \text{tr}(\boldsymbol{\sigma}) \quad (107.18)$$

2. The Cockcroft-Latham damage evolution rule:

$$\dot{D} = \frac{D_c}{W_c} \max(\sigma_1, 0) \dot{p} \tag{107.19}$$

Where  $D_c$ ,  $W_c$  are material parameters.

Adiabatic heating is calculated as

$$\dot{T} = \chi \frac{\boldsymbol{\sigma} : \mathbf{d}^p}{\rho C_p} = \chi \frac{\tilde{\sigma}_{eq} \dot{\epsilon}}{\rho C_p} \tag{107.20}$$

Where  $\chi$  is the Taylor-Quinney parameter,  $\rho$  is the density and  $C_p$  is the specific heat. The initial value of the temperature  $T_0$  may be specified by the user.

Element erosion occurs when one of the following several criteria are fulfilled:

1. The damage is greater than the critical value

$$D \geq D_c \tag{107.21}$$

2. The maximum shear stress is greater than a critical value

$$\tau_{max} = \frac{1}{2} \max\{|\sigma_1 - \sigma_2|, |\sigma_2 - \sigma_3|, |\sigma_3 - \sigma_1|\} \geq \tau_c \tag{107.22}$$

3. The temperature is greater than a critical value

$$T \geq T_c \tag{107.23}$$

<i>History Variable</i>	<i>Description</i>
1	Evaluation of damage D
2	Evaluation of stress triaxiality $\sigma^*$
3	Evaluation of damaged plastic strain r
4	Evaluation of temperature T
5	Evaluation of damaged plastic strain rate $\dot{\epsilon}$
8	Evaluation of plastic work per volume W
9	Evaluation of maximum shear stress $\tau_{max}$

\*MAT\_ORTHO\_ELASTIC\_PLASTIC

This is Material Type 108. This model combines orthotropic elastic plastic behavior with an anisotropic yield criterion. This model is implemented only for shell elements.

Card 1            1            2            3            4            5            6            7            8

Variable	MID	RO	E11	E22	G12	PR12	PR23	PR31
Type	A8	F	F	F	F	F	F	F

Card 2            1            2            3            4            5            6            7            8

Variable	SIGMA0	LC	QR1	CR1	QR2	CR2		
Type	F	I	F	F	F	F		

Card 3            1            2            3            4            5            6            7            8

Variable	R11	R22	R33	R12				
Type	F	F	F	F				

Card 4            1            2            3            4            5            6            7            8

Variable	AOPY	BETA						
Type	F	F						

Card 5            1            2            3            4            5            6            7            8

Variable	XP	YP	ZP	A1	A2	A3		
Type	F	F	F	F	F	F		

Card 6            1            2            3            4            5            6            7            8

Variable	V1	V2	V3	D1	D2	D3		
Type	F	F	F	F	F	F		

**VARIABLE****DESCRIPTION**

MID	Material identification. A unique number or label not exceeding 8 characters must be specified.
RO	Mass Density
E11	Young's Modulus in 11-direction
E22	Young's Modulus in 22-direction
G12	Shear modulus in 12-direction
PR12	Poisson's ratio 12
PR23	Poisson's ratio
PR31	Poisson's ration
LC	Load curve ID. The load curve ID defines effective stress versus effective plastic strain. Values on Card 2 are ignored if this value is defined.
SIGMA0	Initial yield stress, $\sigma_0$
QR1	Isotropic hardening parameter, $Q_{R1}$
CR1	Isotropic hardening parameter, $C_{R1}$

VARIABLE	DESCRIPTION
QR2	Isotropic hardening parameter, $Q_{R2}$
CR2	Isotropic hardening parameter, $C_{R2}$
R11	Yield criteria parameter, $R_{11}$
R22	Yield criteria parameter, $R_{22}$
R33	Yield criteria parameter, $R_{33}$
R12	Yield criteria parameter, $R_{12}$
AOPT	<p>Material axes option (see Mat_ <i>OPTION</i> TROPIC_ELASTIC for a more complete description)</p> <p>EQ.0.0: Locally orthotropic with material axes determined by element nodes as shown in Figure 2.1. Nodes 1, 2 and 4 of an element are identical to the node used for the definition of a coordinate system as by *DEFINE_COORDINATE_NODES, and then rotated about the shell element normal by an angle BETA.</p> <p>EQ.2.0: Globally orthotropic with material axes determined by vectors defined below, as with *DEFINE_COORDINATE_VECTOR.</p> <p>EQ.3.0: Locally orthotropic material axes determined by offsetting the material axes by an angle, OFFANG, from a line determined by taking the cross product of the vector <math>\mathbf{v}</math> with the normal to the plane of the element.</p> <p>LT.0.0: the absolute value of AOPT is a coordinate system ID number (CID on *DEFINE_COORDINATE_NODES, *DEFINE_COORDINATE_SYSTEM or *DEFINE_COORDINATE_VECTOR). Available in R3 version of 971 and later.</p>
BETA	Material angle in degrees for AOPT = 0 and 3. BETA may be overridden on the element card, see *ELEMENT_SHELL_BETA.
XP YP ZP	Coordinates of point $\mathbf{p}$ for AOPT=1.
A1 A2 A3	Components of vector $\mathbf{a}$ for AOPT=2.
V1 V2 V3	Components of vector $\mathbf{v}$ for AOPT=3.
D1 D2 D3	Components of vector $\mathbf{d}$ for AOPT=2.

**Remarks:**

The yield function is defined as

$$f = \bar{f}(\boldsymbol{\sigma}) - [\sigma_0 + R(\varepsilon^p)]$$

where the equivalent stress  $\sigma_{eq}$  is defined as an anisotropic yield criterion

$$\sigma_{eq} = \sqrt{F(\sigma_{22} - \sigma_{33})^2 + G(\sigma_{33} - \sigma_{11})^2 + H(\sigma_{11} - \sigma_{22})^2 + 2L\sigma_{23}^2 + 2M\sigma_{31}^2 + 2N\sigma_{12}^2}$$

Where F, G, H, L, M and N are constants obtained by test of the material in different orientations. They are defined as

$$F = \frac{1}{2} \left( \frac{1}{R_{22}^2} + \frac{1}{R_{33}^2} - \frac{1}{R_{11}^2} \right)$$

$$G = \frac{1}{2} \left( \frac{1}{R_{33}^2} + \frac{1}{R_{11}^2} - \frac{1}{R_{22}^2} \right)$$

$$H = \frac{1}{2} \left( \frac{1}{R_{11}^2} + \frac{1}{R_{22}^2} - \frac{1}{R_{33}^2} \right)$$

$$L = \frac{3}{2R_{23}^2}$$

$$M = \frac{3}{2R_{13}^2}$$

$$N = \frac{3}{2R_{31}^2}$$

The yield stress ratios are defined as follows

$$R_{11} = \frac{\bar{\sigma}_{11}}{\sigma_0}$$

$$R_{22} = \frac{\bar{\sigma}_{22}}{\sigma_0}$$

$$R_{33} = \frac{\bar{\sigma}_{33}}{\sigma_0}$$

$$R_{12} = \frac{\bar{\sigma}_{12}}{\tau_0}$$

$$R_{23} = \frac{\bar{\sigma}_{23}}{\tau_0}$$

$$R_{31} = \frac{\bar{\sigma}_{31}}{\tau_0}$$



where  $\sigma_{ij}$  is the measured yield stress values,  $\sigma_0$  is the reference yield stress and  $\tau_0 = \sigma_0 / \sqrt{3}$ .

The strain hardening is either defined by the load curve or the strain hardening  $R$  is defined by the extended Voce law,

$$R(\varepsilon^p) = \sum_{i=1}^2 Q_{Ri} (1 - \exp(-C_{Ri} \varepsilon^p))$$

where  $\varepsilon^p$  is the effective (or accumulated) plastic strain, and  $Q_{Ri}$  and  $C_{Ri}$  are strain hardening parameters.

**\*MAT\_JOHNSON\_HOLMQUIST\_CERAMICS**

This is Material Type 110. This Johnson-Holmquist Plasticity Damage Model is useful for modeling ceramics, glass and other brittle materials. A more detailed description can be found in a paper by Johnson and Holmquist [1993].

Card 1            1            2            3            4            5            6            7            8

Variable	MID	RO	G	A	B	C	M	N
Type	A8	F	F	F	F	F	F	F

Card 2            1            2            3            4            5            6            7            8

Variable	EPSI	T	SFMAX	HEL	PHEL	BETA		
Type	F	F	F	F	F	F		

Card 3            1            2            3            4            5            6            7            8

Variable	D1	D2	K1	K2	K3	FS		
Type	F	F	F	F	F	F		

<u>VARIABLE</u>	<u>DESCRIPTION</u>
MID	Material identification. A unique number or label not exceeding 8 characters must be specified.
RO	Density
G	Shear modulus
A	Intact normalized strength parameter
B	Fractured normalized strength parameter
C	Strength parameter (for strain rate dependence)

VARIABLE	DESCRIPTION
M	Fractured strength parameter (pressure exponent)
N	Intact strength parameter (pressure exponent).
EPS0	Quasi-static threshold strain rate. See *MAT_015.
T	Maximum tensile pressure strength.
SFMAX	Maximum normalized fractured strength (if Eq.0, defaults to 1e20).
HEL	Hugoniot elastic limit.
PHEL	Pressure component at the Hugoniot elastic limit.
BETA	Fraction of elastic energy loss converted to hydrostatic energy (affects bulking pressure (history variable 1) that accompanies damage).
D1	Parameter for plastic strain to fracture.
D2	Parameter for plastic strain to fracture (exponent).
K1	First pressure coefficient (equivalent to the bulk modulus).
K2	Second pressure coefficient.
K3	Third pressure coefficient.
FS	Failure criteria. FS < 0 fail if $p^* + t^* < 0$ (tensile failure). FS = 0 no failure (default). FS > 0 fail if the effective plastic strain > FS.

**Remarks:**

The equivalent stress for a ceramic-type material is given by

$$\sigma^* = \sigma_i^* - D(\sigma_i^* - \sigma_f^*)$$

where

$$\sigma_i^* = a(p^* + t^*)^n (1 + c \ln \varepsilon^*)$$

represents the intact, undamaged behavior,

$$D = \sum \Delta \varepsilon^p / \varepsilon_f^p$$

represents the accumulated damage (history variable 2) based upon the increase in plastic strain per computational cycle and the plastic strain to fracture

$$\epsilon_f^p = d_1 (p^* + t^*)^{d_2}$$

and

$$\sigma_f^* = b (p^*)^m (1 + c \ln \dot{\epsilon}) \leq SFMAX$$

represents the damaged behavior. In each case, the '\*' indicates a normalized quantity, the stresses being normalized by the equivalent stress at the Hugoniot elastic limit (see below), the pressures by the pressure at the Hugoniot elastic limit (see below) and the strain rate by the reference strain rate. The parameter d1 controls the rate at which damage accumulates. If it is made 0, full damage occurs in one time step i.e. instantaneously. It is also the best parameter to vary if one attempts to reproduce results generated by another finite element program.

In undamaged material, the hydrostatic pressure is given by

$$P = k_1 \mu + k_2 \mu^2 + k_3 \mu^3$$

in compression and

$$P = k_1 \mu$$

in tension where  $\mu = \rho / \rho_0 - 1$ . When damage starts to occur, there is an increase in pressure. A fraction, between 0 and 1, of the elastic energy loss,  $\beta$ , is converted into hydrostatic potential energy (pressure). The details of this pressure increase are given in the reference.

Given *hel* and *g*,  $\mu_{hel}$  can be found iteratively from

$$hel = k_1 \mu_{hel} + k_2 \mu_{hel}^2 + k_3 \mu_{hel}^3 + (4/3) g (\mu_{hel} / (1 + \mu_{hel}))$$

and, subsequently, for normalization purposes,

$$P_{hel} = k_1 \mu_{hel} + k_2 \mu_{hel}^2 + k_3 \mu_{hel}^3$$

and

$$\sigma_{hel} = 1.5 (hel - P_{hel})$$

These are calculated automatically by LS-DYNA if  $\rho_{f0}$  is zero on input.

\*MAT\_JOHNSON\_HOLMQUIST\_CONCRETE

This is Material Type 111. This model can be used for concrete subjected to large strains, high strain rates and high pressures. The equivalent strength is expressed as a function of the pressure, strain rate, and damage. The pressure is expressed as a function of the volumetric strain and includes the effect of permanent crushing. The damage is accumulated as a function of the plastic volumetric strain, equivalent plastic strain and pressure. A more detailed description of this model can be found in the paper by Holmquist, Johnson, and Cook [1993].

Card 1            1            2            3            4            5            6            7            8

Variable	MID	RO	G	A	B	C	N	FC
Type	A8	F	F	F	F	F	F	F

Card 2            1            2            3            4            5            6            7            8

Variable	T	EPS0	EFMIN	SFMAX	PC	UC	PL	UL
Type	F	F	F	F	F	F	F	F

Card 3            1            2            3            4            5            6            7            8

Variable	D1	D2	K1	K2	K3	FS		
Type	F	F	F	F	F	F		

<u>VARIABLE</u>	<u>DESCRIPTION</u>
MID	Material identification. A unique number or label not exceeding 8 characters must be specified.
RO	Mass density.
G	Shear modulus.
A	Normalized cohesive strength.
B	Normalized pressure hardening.

<u>VARIABLE</u>	<u>DESCRIPTION</u>
C	Strain rate coefficient.
N	Pressure hardening exponent.
FC	Quasi-static uniaxial compressive strength.
T	Maximum tensile hydrostatic pressure.
EPS0	Quasi-static threshold strain rate. See *MAT_015.
EFMIN	Amount of plastic strain before fracture.
SFMAX	Normalized maximum strength.
PC	Crushing pressure.
UC	Crushing volumetric strain.
PL	Locking pressure.
UL	Locking volumetric strain.
D1	Damage constant.
D2	Damage constant.
K1	Pressure constant.
K2	Pressure constant.
K3	Pressure constant.
FS	Failure type: FS < 0 fail if damage strength < 0 FS = 0 fail if $P^* + T^* \leq 0$ (tensile failure). FS > 0 fail if the effective plastic strain > FS.

**Remarks:**

The normalized equivalent stress is defined as

$$\sigma^* = \frac{\sigma}{f'}$$

where  $\sigma$  is the actual equivalent stress, and  $f'$  is the quasi-static uniaxial compressive strength. The expression is defined as:

$$\sigma^* = \left[ A(1-D) + BP^{*N} \right] \left[ 1 + C \ln(\dot{\varepsilon}^*) \right]$$

where  $D$  is the damage parameter,  $P^* = P/f'_c$  is the normalized pressure and  $\dot{\varepsilon}^* = \dot{\varepsilon}/\dot{\varepsilon}_0$  is the dimensionless strain rate. The model incrementally accumulates damage,  $D$ , both from equivalent plastic strain and plastic volumetric strain, and is expressed as

$$D = \sum \frac{\Delta\varepsilon_p + \Delta\mu_p}{D_1(P^* + T^*)^{D_2}}$$

where  $\Delta\varepsilon_p$  and  $\Delta\mu_p$  are the equivalent plastic strain and plastic volumetric strain,  $D_1$  and  $D_2$  are material constants and  $T^* = T/f'_c$  is the normalized maximum tensile hydrostatic pressure.

The damage strength,  $DS$ , is defined in compression when  $P^* > 0$  as

$$DS = f'_c \cdot \text{MIN} \left[ SFMAX, A(1-D) + BP^{*N} \right] \left[ 1 + C \ln(\dot{\varepsilon}^*) \right]$$

Or in tension if  $P^* < 0$ , as

$$DS = f'_c \cdot \text{MAX} \left[ 0, A(1-D) - A \left( \frac{P^*}{T} \right) \right] \left[ 1 + C \ln(\dot{\varepsilon}^*) \right]$$

The pressure for fully dense material is expressed as

$$P = K_1 \bar{\mu} + K_2 \bar{\mu}^2 + K_3 \bar{\mu}^3$$

where  $K_1$ ,  $K_2$  and  $K_3$  are material constants and the modified volumetric strain is defined as

$$\bar{\mu} = \frac{\mu - \mu_{lock}}{1 + \mu_{lock}}$$

where  $\mu_{lock}$  is the locking volumetric strain.

# \*MAT\_112

# \*MAT\_FINITE\_ELASTIC\_STRAIN\_PLASTICITY

## \*MAT\_FINITE\_ELASTIC\_STRAIN\_PLASTICITY

This is Material Type 112. An elasto-plastic material with an arbitrary stress versus strain curve and arbitrary strain rate dependency can be defined. The elastic response of this model uses a finite strain formulation so that large elastic strains can develop before yielding occurs. This model is available for solid elements only. See Remarks below.

Card 1            1            2            3            4            5            6            7            8

Variable	MID	RO	E	PR	SIGY	ETAN		
Type	A8	F	F	F	F	F		
Default	none	none	none	none	none	0.0		

Card 2            1            2            3            4            5            6            7            8

Variable	C	P	LCSS	LCSR				
Type	F	F	F	F				
Default	0	0	0	0				

Card 3            1            2            3            4            5            6            7            8

Variable	EPS1	EPS2	EPS3	EPS4	EPS5	EPS6	EPS7	EPS8
Type	F	F	F	F	F	F	F	F
Default	0	0	0	0	0	0	0	0



Card 4            1            2            3            4            5            6            7            8

Variable	ES1	ES2	ES3	ES4	ES5	ES6	ES7	ES8
Type	F	F	F	F	F	F	F	F
Default	0	0	0	0	0	0	0	0

**VARIABLE**

**DESCRIPTION**

- MID            Material identification. A unique number or label not exceeding 8 characters must be specified.
- RO            Mass density.
- E            Young's modulus.
- PR            Poisson's ratio.
- SIGY          Yield stress.
- ETAN          Tangent modulus, ignored if (LCSS.GT.0) is defined.
- C            Strain rate parameter, C, see formula below.
- P            Strain rate parameter, P, see formula below.
- LCSS          Load curve ID or Table ID. Load curve ID defining effective stress versus effective plastic strain. If defined EPS1-EPS8 and ES1-ES8 are ignored. The table ID defines for each strain rate value a load curve ID giving the stress versus effective plastic strain for that rate, See Figure 24.1. The stress versus effective plastic strain curve for the lowest value of strain rate is used if the strain rate falls below the minimum value. Likewise, the stress versus effective plastic strain curve for the highest value of strain rate is used if the strain rate exceeds the maximum value. The strain rate parameters: C and P; the curve ID, LCSR; EPS1-EPS8 and ES1-ES8 are ignored if a Table ID is defined.
- LCSR          Load curve ID defining strain rate scaling effect on yield stress.
- EPS1-EPS8    Effective plastic strain values (optional if SIGY is defined). At least 2 points should be defined. The first point must be zero corresponding to the initial yield stress. WARNING: If the first point is nonzero the yield stress is extrapolated to determine the initial yield. If this option is used SIGY and ETAN are ignored and may be input as zero.

<u>VARIABLE</u>	<u>DESCRIPTION</u>
ES1-ES8	Corresponding yield stress values to EPS1 - EPS8.

**Remarks:**

The stress strain behavior may be treated by a bilinear stress strain curve by defining the tangent modulus, ETAN. Alternately, a curve similar to that shown in Figure 10.1 is expected to be defined by (EPS1,ES1) - (EPS8,ES8); however, an effective stress versus effective plastic strain curve (LCSS) may be input instead if eight points are insufficient. The cost is roughly the same for either approach. The most general approach is to use the table definition (LCSS) discussed below.

Three options to account for strain rate effects are possible.

- I. Strain rate may be accounted for using the Cowper and Symonds model which scales the yield stress with the factor

$$1 + \left( \frac{\dot{\epsilon}}{C} \right)^{1/p}$$

where  $\dot{\epsilon}$  is the strain rate,  $\dot{\epsilon} = \sqrt{\dot{\epsilon}_{ij} \dot{\epsilon}_{ij}}$ .

- II. For complete generality a load curve (LCSR) to scale the yield stress may be input instead. In this curve the scale factor versus strain rate is defined.
- III. If different stress versus strain curves can be provided for various strain rates, the option using the reference to a table (LCSS) can be used. Then the table input in \*DEFINE\_TABLE has to be used, see Figure 24.1.

\*MAT\_TRIP

This is Material Type 113. This isotropic elasto-plastic material model applies to shell elements only. It features a special hardening law aimed at modelling the temperature dependent hardening behavior of austenitic stainless TRIP-steels. TRIP stands for Transformation Induced Plasticity. A detailed description of this material model can be found in Hänsel, Hora, and Reissner [1998] and Schedin, Prentzas, and Hilding [2004].

Card 1            1            2            3            4            5            6            7            8

Variable	MID	RO	E	PR	CP	T0	TREF	TA0
Type	A8	F	F					
Default								

Card 2            1            2            3            4            5            6            7            8

Variable	A	B	C	D	P	Q	E0MART	VM0
Type	F	F						
Default								

Card 3            1            2            3            4            5            6            7            8

Variable	AHS	BHS	M	N	EPS0	HMART	K1	K2
Type								
Default								

**VARIABLE**

**DESCRIPTION**

MID

Material identification. A unique number or label not exceeding 8 characters must be specified.

VARIABLE	DESCRIPTION
RO	Mass density.
E	Young's modulus.
PR	Poisson's ratio.
CP	Adiabatic temperature calculation option: EQ.0.0: Adiabatic temperature calculation is disabled. GT.0.0: CP is the specific heat $C_p$ . Adiabatic temperature calculation is enabled.
T0	Initial temperature $T_0$ of the material if adiabatic temperature calculation is enabled.
TREF	Reference temperature for output of the yield stress as history variable 1.
TA0	Reference temperature $T_{A0}$ , the absolute zero for the used temperature scale, e.g. -273.15 if the Celsius scale is used and 0.0 if the Kelvin scale is used.
A	Martensite rate equation parameter $A$ , see equations below.
B	Martensite rate equation parameter $B$ , see equations below.
C	Martensite rate equation parameter $C$ , see equations below.
D	Martensite rate equation parameter $D$ , see equations below.
P	Martensite rate equation parameter $p$ , see equations below.
Q	Martensite rate equation parameter $Q$ , see equations below.
E0MART	Martensite rate equation parameter $E_{0(mart)}$ , see equations below.
VM0	The initial volume fraction of martensite $0.0 < V_{m0} < 1.0$ may be initialised using two different methods: GT.0.0: $V_{m0}$ is set to VM0. LT.0.0: Can be used only when there are initial plastic strains $\epsilon^p$ present, e.g. when using *INITIAL_STRESS_SHELL. The absolute value of VM0 is then the load curve ID for a function $f$ that sets $V_{m0} = f(\epsilon^p)$ . The function $f$ must be a monotonically nondecreasing function of $\epsilon^p$ .
AHS	Hardening law parameter $A_{HS}$ , see equations below.
BHS	Hardening law parameter $B_{HS}$ , see equations below.

VARIABLE	DESCRIPTION
M	Hardening law parameter $m$ , see equations below.
N	Hardening law parameter $n$ , see equations below.
EPS0	Hardening law parameter $\varepsilon_0$ , see equations below.
HMART	Hardening law parameter $\Delta H_{\gamma \rightarrow \alpha'}$ , see equations below.
K1	Hardening law parameter $K_1$ , see equations below.
K2	Hardening law parameter $K_2$ , see equations below.

### Remarks:

Here a short description is given of the TRIP-material model. The material model uses the von Mises yield surface in combination with isotropic hardening. The hardening is temperature dependent and therefore this material model must be run either in a coupled thermo-mechanical solution, using prescribed temperatures or using the adiabatic temperature calculation option. Setting the parameter CP to the specific heat  $C_p$  of the material activates the adiabatic temperature calculation that calculates the temperature rate from the equation

$$\dot{T} = \frac{\sigma \cdot D^p}{\rho C_p},$$

where  $\sigma \cdot D^p$  is the plastically dissipated heat. Using the Kelvin scale is recommended, even though other scales may be used without problems.

The hardening behavior is described by the following equations. The Martensite rate equation is

$$\frac{\partial V_m}{\partial \bar{\varepsilon}^p} = \begin{cases} 0, & \text{if } \varepsilon < E_{0(mart)} \\ \frac{B}{A} \exp\left(\frac{Q}{T - T_{A0}}\right) \left(\frac{1 - V_m}{V_m}\right)^{(B+1)/B} V_m^p \frac{1}{2} (1 - \tanh(C + D \cdot T)), & \text{if } \bar{\varepsilon}^p \geq E_{0(mart)} \end{cases},$$

where

$\bar{\varepsilon}^p$  = effective plastic strain and  
 $T$  = temperature.

The martensite fraction is integrated from the above rate equation:

$$V_m = \int_0^{\varepsilon} \frac{\partial V_m}{\partial \bar{\varepsilon}^p} d\bar{\varepsilon}^p.$$

It always holds that  $0.0 < V_m < 1.0$ . The initial martensite content is  $V_{m0}$  and must be greater than zero and less than 1.0. Note that  $V_{m0}$  is not used during a restart or when initializing the  $V_m$  history variable using \*INITIAL\_STRESS\_SHELL.

The yield stress  $\sigma_y$  is

$$\sigma_y = \left\{ B_{HS} - (B_{HS} - A_{HS}) \exp\left(-m \left[ \bar{\epsilon}^p + \epsilon_0 \right]^n \right) \right\} (K_1 + K_2 T) + \Delta H_{\gamma \rightarrow \alpha} V_m.$$

The parameters p and B should fulfill the following condition

$$(1+B)/B < p,$$

if not fulfilled then the martensite rate will approach infinity as  $V_m$  approaches zero. Setting the parameter  $\epsilon_0$  larger than zero, typical range 0.001-0.02 is recommended. A part from the effective true strain a few additional history variables are output, see below.

History variables that are output for post-processing:

<i>Variable</i>	<i>Description</i>
1	Yield stress of material at temperature TREF. Useful to evaluate the strength of the material after e.g., a simulated forming operation.
2	Volume fraction martensite, $V_m$
3	CP EQ.0.0: Not used CP GT.0.0: Temperature from adiabatic temperature calculation

\*MAT\_LAYERED\_LINEAR\_PLASTICITY

This is Material Type 114. A layered elastoplastic material with an arbitrary stress versus strain curve and an arbitrary strain rate dependency can be defined. This material must be used with the user defined integration rules, see \*INTEGRATION-SHELL, for modeling laminated composite and sandwich shells where each layer can be represented by elastoplastic behavior with constitutive constants that vary from layer to layer. Lamination theory is applied to correct for the assumption of a uniform constant shear strain through the thickness of the shell. Unless this correction is applied, the stiffness of the shell can be grossly incorrect leading to poor results. Generally, without the correction the results are too stiff. This model is available for shell elements only. Also, see Remarks below.

Card 1            1            2            3            4            5            6            7            8

Variable	MID	RO	E	PR	SIGY	ETAN	FAIL	TDEL
Type	A8	F	F	F	F	F	F	F
Default	none	none	none	none	none	0.0	10.E+20	0

Card 2            1            2            3            4            5            6            7            8

Variable	C	P	LCSS	LCSR				
Type	F	F	F	F				
Default	0	0	0	0				

Card 3            1            2            3            4            5            6            7            8

Variable	EPS1	EPS2	EPS3	EPS4	EPS5	EPS6	EPS7	EPS8
Type	F	F	F	F	F	F	F	F
Default	0	0	0	0	0	0	0	0

Card 4            1            2            3            4            5            6            7            8

Variable	ES1	ES2	ES3	ES4	ES5	ES6	ES7	ES8
Type	F	F	F	F	F	F	F	F
Default	0	0	0	0	0	0	0	0

<u>VARIABLE</u>	<u>DESCRIPTION</u>
MID	Material identification. A unique number or label not exceeding 8 characters must be specified.
RO	Mass density.
E	Young's modulus.
PR	Poisson's ratio.
SIGY	Yield stress.
ETAN	Tangent modulus, ignored if (LCSS.GT.0) is defined.
FAIL	Failure flag. LT.0.0: User defined failure subroutine, matusr_24 in dyn21.F, is called to determine failure EQ.0.0: Failure is not considered. This option is recommended if failure is not of interest since many calculations will be saved. GT.0.0: Plastic strain to failure. When the plastic strain reaches this value, the element is deleted from the calculation.
TDEL	Minimum time step size for automatic element deletion.
C	Strain rate parameter, C, see formula below.
P	Strain rate parameter, P, see formula below.



VARIABLE	DESCRIPTION
LCSS	Load curve ID or Table ID. Load curve ID defining effective stress versus effective plastic strain. If defined EPS1-EPS8 and ES1-ES8 are ignored. The table ID defines for each strain rate value a load curve ID giving the stress versus effective plastic strain for that rate, See Figure 24.1. The stress versus effective plastic strain curve for the lowest value of strain rate is used if the strain rate falls below the minimum value. Likewise, the stress versus effective plastic strain curve for the highest value of strain rate is used if the strain rate exceeds the maximum value. The strain rate parameters: C and P; the curve ID, LCSR; EPS1-EPS8 and ES1-ES8 are ignored if a Table ID is defined.
LCSR	Load curve ID defining strain rate scaling effect on yield stress.
EPS1-EPS8	Effective plastic strain values (optional if SIGY is defined). At least 2 points should be defined. The first point must be zero corresponding to the initial yield stress. WARNING: If the first point is nonzero the yield stress is extrapolated to determine the initial yield. If this option is used SIGY and ETAN are ignored and may be input as zero.
ES1-ES8	Corresponding yield stress values to EPS1 - EPS8.

### **Remarks:**

The stress strain behavior may be treated by a bilinear stress strain curve by defining the tangent modulus, ETAN. Alternately, a curve similar to that shown in Figure 10.1 is expected to be defined by (EPS1,ES1) - (EPS8,ES8); however, an effective stress versus effective plastic strain curve (LCSS) may be input instead if eight points are insufficient. The cost is roughly the same for either approach. The most general approach is to use the table definition (LCSS) discussed below.

Three options to account for strain rate effects are possible.

- I. Strain rate may be accounted for using the Cowper and Symonds model which scales the yield stress with the factor

$$1 + \left( \frac{\dot{\epsilon}}{C} \right)^{1/p}$$

where  $\dot{\epsilon}$  is the strain rate,  $\dot{\epsilon} = \sqrt{\dot{\epsilon}_{ij} \dot{\epsilon}_{ij}}$ .

- II. For complete generality a load curve (LCSR) to scale the yield stress may be input instead. In this curve the scale factor versus strain rate is defined.

- III. If different stress versus strain curves can be provided for various strain rates, the option using the reference to a table (LCSS) can be used. Then the table input in \*DEFINE\_TABLE has to be used, see Figure 24.1.

\*MAT\_UNIFIED\_CREEP

This is Material Type 115. This is an elastic creep model for modeling creep behavior when plastic behavior is not considered.

Card 1            1            2            3            4            5            6            7            8

Variable	MID	RO	E	PR	A	N	M	
Type	A8	F	F	F	F	F	F	
Default	none	none	none	none	none	none	none	

<u>VARIABLE</u>	<u>DESCRIPTION</u>
MID	Material identification. A unique number or label not exceeding 8 characters must be specified.
RO	Mass density.
E	Young's modulus.
PR	Poisson's ratio.
A	Stress coefficient.
N	Stress exponent.
M	Time exponent.

**Remarks:**

The effective creep strain,  $\bar{\epsilon}^c$ , given as:

$$\bar{\epsilon}^c = A\bar{\sigma}^n \bar{t}^m$$

where  $A$ ,  $n$ , and  $m$  are constants and  $\bar{t}$  is the effective time. The effective stress,  $\bar{\sigma}$ , is defined as:

$$\bar{\sigma} = \sqrt{\frac{3}{2} \sigma_{ij} \sigma_{ij}}$$

The creep strain, therefore, is only a function of the deviatoric stresses. The volumetric behavior for this material is assumed to be elastic. By varying the time constant  $m$  primary creep ( $m < 1$ ), secondary creep ( $m = 1$ ), and tertiary creep ( $m > 1$ ) can be modeled. This model is described by Whirley and Henshall [1992].

**\*MAT\_COMPOSITE\_LAYUP**

This is Material Type 116. This material is for modeling the elastic responses of composite layups that have an arbitrary number of layers through the shell thickness. A pre-integration is used to compute the extensional, bending, and coupling stiffness for use with the Belytschko-Tsay resultant shell formulation. The angles of the local material axes are specified from layer to layer in the \*SECTION\_SHELL input. This material model must be used with the user defined integration rule for shells, see \*INTEGRATION\_SHELL, which allows the elastic constants to change from integration point to integration point. Since the stresses are not computed in the resultant formulation, the stresses output to the binary databases for the resultant elements are zero. Note that this shell *does not use laminated shell theory* and that storage is allocated for just one integration point (as reported in D3HSP) regardless of the layers defined in the integration rule.

Card 1            1            2            3            4            5            6            7            8

Variable	MID	RO	EA	EB	EC	PRBA	PRCA	PRCB
Type	A8	F	F	F	F	F	F	F

Card 2            1            2            3            4            5            6            7            8

Variable	GAB	GBC	GCA	AOPT				
Type	F	F	F	F				

Card 3            1            2            3            4            5            6            7            8

Variable	XP	YP	ZP	A1	A2	A3		
Type	F	F	F	F	F	F		

Card 4            1            2            3            4            5            6            7            8

Variable	V1	V2	V3	D1	D2	D3	BETA	
Type	F	F	F	F	F	F	F	

<u>VARIABLE</u>	<u>DESCRIPTION</u>
MID	Material identification. A unique number or label not exceeding 8 characters must be specified.
RO	Mass density.
EA	$E_a$ , Young's modulus in a-direction.
EB	$E_b$ , Young's modulus in b-direction.
EC	$E_c$ , Young's modulus in c-direction.
PRBA	$\nu_{ba}$ , Poisson's ratio ba.
PRCA	$\nu_{ca}$ , Poisson's ratio ca.
PRCB	$\nu_{cb}$ , Poisson's ratio cb.
GAB	$G_{ab}$ , shear modulus ab.
GBC	$G_{bc}$ , shear modulus bc.
GCA	$G_{ca}$ , shear modulus ca.

VARIABLE	DESCRIPTION
AOPT	<p>Material axes option, see Figure 2.1:</p> <p>EQ.0.0: locally orthotropic with material axes determined by element nodes as shown in Figure 2.1. Nodes 1, 2, and 4 of an element are identical to the nodes used for the definition of a coordinate system as by *DEFINE_COORDINATE_NODES, and then rotated about the shell element normal by an angle BETA.</p> <p>EQ.2.0: globally orthotropic with material axes determined by vectors defined below, as with *DEFINE_COORDINATE_VECTOR.</p> <p>EQ.3.0: locally orthotropic material axes determined by rotating the material axes about the element normal by an angle, BETA, from a line in the plane of the element defined by the cross product of the vector <b>v</b> with the element normal.</p> <p>LT.0.0: the absolute value of AOPT is a coordinate system ID number (CID on *DEFINE_COORDINATE_NODES, *DEFINE_COORDINATE_SYSTEM or *DEFINE_COORDINATE_VECTOR). Available in R3 version of 971 and later.</p>
XP YP ZP	Define coordinates of point <b>p</b> for AOPT = 1 and 4.
A1 A2 A3	Define components of vector <b>a</b> for AOPT = 2.
V1 V2 V3	Define components of vector <b>v</b> for AOPT = 3 and 4.
D1 D2 D3	Define components of vector <b>d</b> for AOPT = 2.
BETA	Material angle in degrees for AOPT = 0 and 3, may be overridden on the element card, see *ELEMENT_SHELL_BETA.

**Remarks:**

This material law is based on standard composite lay-up theory. The implementation, [Jones 1975], allows the calculation of the force,  $N$ , and moment,  $M$ , stress resultants from:

$$\begin{Bmatrix} N_x \\ N_y \\ N_{xy} \end{Bmatrix} = \begin{bmatrix} A_{11} & A_{12} & A_{16} \\ A_{21} & A_{22} & A_{26} \\ A_{16} & A_{26} & A_{66} \end{bmatrix} \begin{Bmatrix} \epsilon_x^0 \\ \epsilon_y^0 \\ \epsilon_z^0 \end{Bmatrix} + \begin{bmatrix} B_{11} & B_{12} & B_{16} \\ B_{21} & B_{22} & B_{26} \\ B_{16} & B_{26} & B_{66} \end{bmatrix} \begin{Bmatrix} \kappa_x \\ \kappa_y \\ \kappa_{xy} \end{Bmatrix}$$

$$\begin{Bmatrix} M_x \\ M_y \\ M_{xy} \end{Bmatrix} = \begin{bmatrix} B_{11} & B_{12} & B_{16} \\ B_{21} & B_{22} & B_{26} \\ B_{16} & B_{26} & B_{66} \end{bmatrix} \begin{Bmatrix} \epsilon_x^0 \\ \epsilon_y^0 \\ \epsilon_z^0 \end{Bmatrix} + \begin{bmatrix} D_{11} & D_{12} & D_{16} \\ D_{21} & D_{22} & D_{26} \\ D_{16} & D_{26} & D_{66} \end{bmatrix} \begin{Bmatrix} \kappa_x \\ \kappa_y \\ \kappa_{xy} \end{Bmatrix}$$

where  $A_{ij}$  is the extensional stiffness,  $D_{ij}$  is the bending stiffness, and  $B_{ij}$  is the coupling stiffness which is a null matrix for symmetric lay-ups. The mid-surface strains and curvatures are denoted by  $\varepsilon_{ij}^0$  and  $\kappa_{ij}$  respectively. Since these stiffness matrices are symmetric, 18 terms are needed per shell element in addition to the shell resultants which are integrated in time. This is considerably less storage than would typically be required with through thickness integration which requires a minimum of eight history variables per integration point, e.g., if 100 layers are used 800 history variables would be stored. Not only is memory much less for this model, but the CPU time required is also considerably reduced.

**\*MAT\_COMPOSITE\_MATRIX**

This is Material Type 117. This material is used for modeling the elastic responses of composites where a pre-integration is used to compute the extensional, bending, and coupling stiffness coefficients for use with the Belytschko-Tsay resultant shell formulation. Since the stresses are not computed in the resultant formulation, the stresses output to the binary databases for the resultant elements are zero.

Card 1            1            2            3            4            5            6            7            8

Variable	MID	RO						
Type	A8	F						

Card 2            1            2            3            4            5            6            7            8

Variable	C11	C12	C22	C13	C23	C33	C14	C24
Type	F	F	F	F	F	F	F	F

Card 3            1            2            3            4            5            6            7            8

Variable	C34	C44	C15	C25	C35	C45	C55	C16
Type	F	F	F	F	F	F	F	F

Card 4            1            2            3            4            5            6            7            8

Variable	C26	C36	C46	C56	C66	AOPT		
Type	F	F	F	F	F	F		



Card 5            1            2            3            4            5            6            7            8

Variable	XP	YP	ZP	A1	A2	A3		
Type	F	F	F	F	F	F		

Card 6            1            2            3            4            5            6            7            8

Variable	V1	V2	V3	D1	D2	D3	BETA	
Type	F	F	F	F	F	F	F	

<u>VARIABLE</u>	<u>DESCRIPTION</u>
MID	Material identification. A unique number or label not exceeding 8 characters must be specified.
RO	Mass density.
CIJ	$C_{ij}$ coefficients of stiffness matrix.
AOPT	Material axes option, see Figure 2.1: EQ.0.0: locally orthotropic with material axes determined by element nodes as shown in Figure 2.1. Nodes 1, 2, and 4 of an element are identical to the nodes used for the definition of a coordinate system as by *DEFINE_COORDINATE_NODES, and then rotated about the shell element normal by an angle BETA. EQ.2.0: globally orthotropic with material axes determined by vectors defined below, as with *DEFINE_COORDINATE_VECTOR. EQ.3.0: locally orthotropic material axes determined by rotating the material axes about the element normal by an angle, BETA, from a line in the plane of the element defined by the cross product of the vector <b>v</b> with the element normal. LT.0.0: the absolute value of AOPT is a coordinate system ID number (CID on *DEFINE_COORDINATE_NODES, *DEFINE_COORDINATE_SYSTEM or *DEFINE_COORDINATE_VECTOR). Available in R3 version of 971 and later.
XP YP ZP	Define coordinates of point <b>p</b> for AOPT = 1 and 4.
A1 A2 A3	Define components of vector <b>a</b> for AOPT = 2.

VARIABLE	DESCRIPTION
V1 V2 V3	Define components of vector <b>v</b> for AOPT = 3 and 4.
D1 D2 D3	Define components of vector <b>d</b> for AOPT = 2.
BETA	Material angle in degrees for AOPT = 0 and 3, may be overridden on the element card, see *ELEMENT_SHELL_BETA.

**Remarks:**

The calculation of the force,  $N_{ij}$ , and moment,  $M_{ij}$ , stress resultants is given in terms of the membrane strains,  $\epsilon_i^0$ , and shell curvatures,  $\kappa_i$ , as:

$$\begin{Bmatrix} N_x \\ N_y \\ N_{xy} \\ M_x \\ M_y \\ M_{xy} \end{Bmatrix} = \begin{bmatrix} C_{11} & C_{12} & C_{13} & C_{14} & C_{15} & C_{16} \\ C_{21} & C_{22} & C_{23} & C_{24} & C_{25} & C_{26} \\ C_{31} & C_{32} & C_{33} & C_{34} & C_{35} & C_{36} \\ C_{41} & C_{42} & C_{43} & C_{44} & C_{45} & C_{46} \\ C_{51} & C_{52} & C_{53} & C_{54} & C_{55} & C_{56} \\ C_{61} & C_{62} & C_{63} & C_{64} & C_{65} & C_{66} \end{bmatrix} \begin{Bmatrix} \epsilon_x^0 \\ \epsilon_y^0 \\ \epsilon_z^0 \\ \kappa_x \\ \kappa_y \\ \kappa_{xy} \end{Bmatrix}$$

where  $C_{ij} = C_{ji}$ . In this model this symmetric matrix is transformed into the element local system and the coefficients are stored as element history variables. In model type \*MAT\_COMPOSITE\_DIRECT below, the resultants are already assumed to be given in the element local system which reduces the storage since the 21 coefficients are not stored as history variables as part of the element data.

The shell thickness is built into the coefficient matrix and, consequently, within the part ID, which references this material ID, the thickness must be uniform.

\*MAT\_COMPOSITE\_DIRECT

This is Material Type 118. This material is used for modeling the elastic responses of composites where a pre-integration is used to compute the extensional, bending, and coupling stiffness coefficients for use with the Belytschko-Tsay resultant shell formulation. Since the stresses are not computed in the resultant formulation, the stresses output to the binary databases for the resultant elements are zero.

Card 1            1            2            3            4            5            6            7            8

Variable	MID	RO						
Type	A8	F						

Card 2            1            2            3            4            5            6            7            8

Variable	C11	C12	C22	C13	C23	C33	C14	C24
Type	F	F	F	F	F	F	F	F

Card 3            1            2            3            4            5            6            7            8

Variable	C34	C44	C15	C25	C35	C45	C55	C16
Type	F	F	F	F	F	F	F	F

Card 4            1            2            3            4            5            6            7            8

Variable	C26	C36	C46	C56	C66			
Type	F	F	F	F	F			

<u>VARIABLE</u>	<u>DESCRIPTION</u>
MID	Material identification. A unique number or label not exceeding 8 characters must be specified.

<u>VARIABLE</u>	<u>DESCRIPTION</u>
RO	Mass density.
CIJ	$C_{ij}$ coefficients of the stiffness matrix.

**Remarks:**

The calculation of the force,  $N_{ij}$ , and moment,  $M_{ij}$ , stress resultants is given in terms of the membrane strains,  $\epsilon_i^0$ , and shell curvatures,  $\kappa_i$ , as:

$$\begin{Bmatrix} N_x \\ N_y \\ N_{xy} \\ M_x \\ M_y \\ M_{xy} \end{Bmatrix} = \begin{bmatrix} C_{11} & C_{12} & C_{13} & C_{14} & C_{15} & C_{16} \\ C_{21} & C_{22} & C_{23} & C_{24} & C_{25} & C_{26} \\ C_{31} & C_{32} & C_{33} & C_{34} & C_{35} & C_{36} \\ C_{41} & C_{42} & C_{43} & C_{44} & C_{45} & C_{46} \\ C_{51} & C_{52} & C_{53} & C_{54} & C_{55} & C_{56} \\ C_{61} & C_{62} & C_{63} & C_{64} & C_{65} & C_{66} \end{bmatrix} \begin{Bmatrix} \epsilon_x^0 \\ \epsilon_y^0 \\ \epsilon_z^0 \\ \kappa_x \\ \kappa_y \\ \kappa_{xy} \end{Bmatrix}$$

where  $C_{ij} = C_{ji}$ . In this model the stiffness coefficients are already assumed to be given in the element local system which reduces the storage. Great care in the element orientation and choice of the local element system, see \*CONTROL\_ACCURACY, must be observed if this model is used.

The shell thickness is built into the coefficient matrix and, consequently, within the part ID, which references this material ID, the thickness must be uniform.

**\*MAT\_GENERAL\_NONLINEAR\_6DOF\_DISCRETE\_BEAM**

This is Material Type 119. This is a very general spring and damper model. This beam is based on the MAT\_SPRING\_GENERAL\_NONLINEAR option. Additional unloading options have been included. The two nodes defining the beam may be coincident to give a zero length beam, or offset to give a finite length beam. For finite length discrete beams the absolute value of the variable SCOOR in the SECTION\_BEAM input should be set to a value of 2.0 or 3.0 to give physically correct behavior. A triad is used to orient the beam for the directional springs.

Card 1            1            2            3            4            5            6            7            8

Variable	MID	RO	KT	KR	UNLDOPT	OFFSET	DAMPF	IFLAG
Type	A8	F	F	F	I	F	F	I

Card 2            1            2            3            4            5            6            7            8

Variable	LCIDTR	LCIDTS	LCIDTT	LCIDRR	LCIDRS	LCIDRT		
Type	I	I	I	I	I	I		

Card 3            1            2            3            4            5            6            7            8

Variable	LCIDTUR	LCIDTUS	LCIDTUT	LCIDRUR	LCIDRUS	LCIDRUT		
Type	I	I	I	I	I	I		

Card 4            1            2            3            4            5            6            7            8

Variable	LCIDTDR	LCIDTDS	LCIDTDT	LCIDRDR	LCIDRDS	LCIDRDT		
Type	I	I	I	I	I	I		



VARIABLE	DESCRIPTION
DAMPF	Damping factor for stability. Values in the neighborhood of unity are recommended. This damping factor is properly scaled to eliminate time step size dependency. Also, it is active if and only if the local stiffness is defined.
IFLAG	Flag for switching between the displacement (default IFLAG=0) and linear strain (IFLAG=1) formulations. The displacement formulation is the one used in all other models. For the linear strain formulation, the displacements and velocities are divided by the initial length of the beam.
UNLDOPT	<p>Unloading option (Also see Figure 119.1.):</p> <p>EQ.0.0: Loading and unloading follow loading curve</p> <p>EQ.1.0: Loading follows loading curve, unloading follows unloading curve. The unloading curve ID if undefined is taken as the loading curve.</p> <p>EQ.2.0: Loading follows loading curve, unloading follows unloading stiffness, KT or KR, to the unloading curve. The loading and unloading curves may only intersect at the origin of the axes.</p> <p>EQ.3.0: Quadratic unloading from peak displacement value to a permanent offset.</p>
OFFSET	Offset factor between 0 and 1.0 to determine permanent set upon unloading if the UNLDOPT=3.0. The permanent sets in compression and tension are equal to the product of this offset value and the maximum compressive and tensile displacements, respectively.
LCIDTR	Load curve ID defining translational force resultant along local r-axis versus relative translational displacement. If zero, no stiffness related forces are generated for this degree of freedom. The loading curves must be defined from the most negative displacement to the most positive displacement. The force does not need to increase monotonically. The curves in this input are linearly extrapolated when the displacement range falls outside the curve definition.
LCIDTS	Load curve ID defining translational force resultant along local s-axis versus relative translational displacement.
LCIDTT	Load curve ID defining translational force resultant along local t-axis versus relative translational displacement.
LCIDRR	Load curve ID defining rotational moment resultant about local r-axis versus relative rotational displacement.
LCIDRS	Load curve ID defining rotational moment resultant about local s-axis versus relative rotational displacement.

<b>VARIABLE</b>	<b>DESCRIPTION</b>
LCIDRT	Load curve ID defining rotational moment resultant about local t-axis versus relative rotational displacement.
LCIDTUR	Load curve ID defining translational force resultant along local r-axis versus relative translational displacement during unloading. The force values defined by this curve must increase monotonically from the most negative displacement to the most positive displacement. For UNLDOPT=1.0, the slope of this curve must equal or exceed the loading curve for stability reasons. This is not the case for UNLDOPT=2.0. For loading and unloading to follow the same path simply set LCIDTUR=LCIDTR. For options UNLDOPT=0.0 or 3.0 the unloading curve is not required.
LCIDTUS	Load curve ID defining translational force resultant along local s-axis versus relative translational displacement during unloading.
LCIDTUT	Load curve ID defining translational force resultant along local t-axis versus relative translational displacement during unloading.
LCIDRUR	Load curve ID defining rotational moment resultant about local r-axis versus relative rotational displacement during unloading.
LCIDRUS	Load curve ID defining rotational moment resultant about local s-axis versus relative rotational displacement during unloading.
LCIDRUT	Load curve ID defining rotational moment resultant about local t-axis versus relative rotational displacement during unloading. If zero, no viscous forces are generated for this degree of freedom.
LCIDTDR	Load curve ID defining translational damping force resultant along local r-axis versus relative translational velocity.
LCIDTDS	Load curve ID defining translational damping force resultant along local s-axis versus relative translational velocity.
LCIDTDT	Load curve ID defining translational damping force resultant along local t-axis versus relative translational velocity.
LCIDRDR	Load curve ID defining rotational damping moment resultant about local r-axis versus relative rotational velocity.
LCIDRDS	Load curve ID defining rotational damping moment resultant about local s-axis versus relative rotational velocity.
LCIDRDT	Load curve ID defining rotational damping moment resultant about local t-axis versus relative rotational velocity.



<u>VARIABLE</u>	<u>DESCRIPTION</u>
LCIDTER	Load curve ID defining translational damping force scale factor versus relative displacement in local r-direction.
LCIDTES	Load curve ID defining translational damping force scale factor versus relative displacement in local s-direction.
LCIDTET	Load curve ID defining translational damping force scale factor versus relative displacement in local t-direction.
LCIDRER	Load curve ID defining rotational damping moment resultant scale factor versus relative displacement in local r-rotation.
LCIDRES	Load curve ID defining rotational damping moment resultant scale factor versus relative displacement in local s-rotation.
LCIDRET	Load curve ID defining rotational damping moment resultant scale factor versus relative displacement in local t-rotation.
UTFAILR	Optional, translational displacement at failure in tension. If zero, the corresponding displacement, $u_r$ , is not considered in the failure calculation.
UTFAILS	Optional, translational displacement at failure in tension. If zero, the corresponding displacement, $u_s$ , is not considered in the failure calculation.
UTFAILT	Optional, translational displacement at failure in tension. If zero, the corresponding displacement, $u_t$ , is not considered in the failure calculation.
WTFAILR	Optional, rotational displacement at failure in tension. If zero, the corresponding rotation, $\theta_r$ , is not considered in the failure calculation.
WTFAILS	Optional, rotational displacement at failure in tension. If zero, the corresponding rotation, $\theta_s$ , is not considered in the failure calculation.
WTFAILT	Optional rotational displacement at failure in tension. If zero, the corresponding rotation, $\theta_t$ , is not considered in the failure calculation.
UCFAILR	Optional, translational displacement at failure in compression. If zero, the corresponding displacement, $u_r$ , is not considered in the failure calculation. Define as a positive number.
UCFAILS	Optional, translational displacement at failure in compression. If zero, the corresponding displacement, $u_s$ , is not considered in the failure calculation. Define as a positive number.

VARIABLE	DESCRIPTION
UCFAILT	Optional, translational displacement at failure in compression. If zero, the corresponding displacement, $u_t$ , is not considered in the failure calculation. Define as a positive number.
WCFAILR	Optional, rotational displacement at failure in compression. If zero, the corresponding rotation, $\theta_r$ , is not considered in the failure calculation. Define as a positive number.
WCFAILS	Optional, rotational displacement at failure in compression. If zero, the corresponding rotation, $\theta_s$ , is not considered in the failure calculation. Define as a positive number.
WCFAILT	Optional, rotational displacement at failure in compression. If zero, the corresponding rotation, $\theta_t$ , is not considered in the failure calculation. Define as a positive number.
IUR	Initial translational displacement along local r-axis.
IUS	Initial translational displacement along local s-axis.
IUT	Initial translational displacement along local t-axis.
IWR	Initial rotational displacement about the local r-axis.
IWS	Initial rotational displacement about the local s-axis.
IWT	Initial rotational displacement about the local t-axis.

**Remarks:**

Catastrophic failure, which is based on displacement resultants, occurs if either of the following inequalities are satisfied:

$$\left(\frac{u_r}{u_r^{tfail}}\right)^2 + \left(\frac{u_s}{u_s^{tfail}}\right)^2 + \left(\frac{u_t}{u_t^{tfail}}\right)^2 + \left(\frac{\theta_r}{\theta_r^{tfail}}\right)^2 + \left(\frac{\theta_s}{\theta_s^{tfail}}\right)^2 + \left(\frac{\theta_t}{\theta_t^{tfail}}\right)^2 - 1. \geq 0$$

$$\left(\frac{u_r}{u_r^{cfail}}\right)^2 + \left(\frac{u_s}{u_s^{cfail}}\right)^2 + \left(\frac{u_t}{u_t^{cfail}}\right)^2 + \left(\frac{\theta_r}{\theta_r^{cfail}}\right)^2 + \left(\frac{\theta_s}{\theta_s^{cfail}}\right)^2 + \left(\frac{\theta_t}{\theta_t^{cfail}}\right)^2 - 1. \geq 0$$

After failure the discrete element is deleted. If failure is included either the tension failure or the compression failure or both may be used.

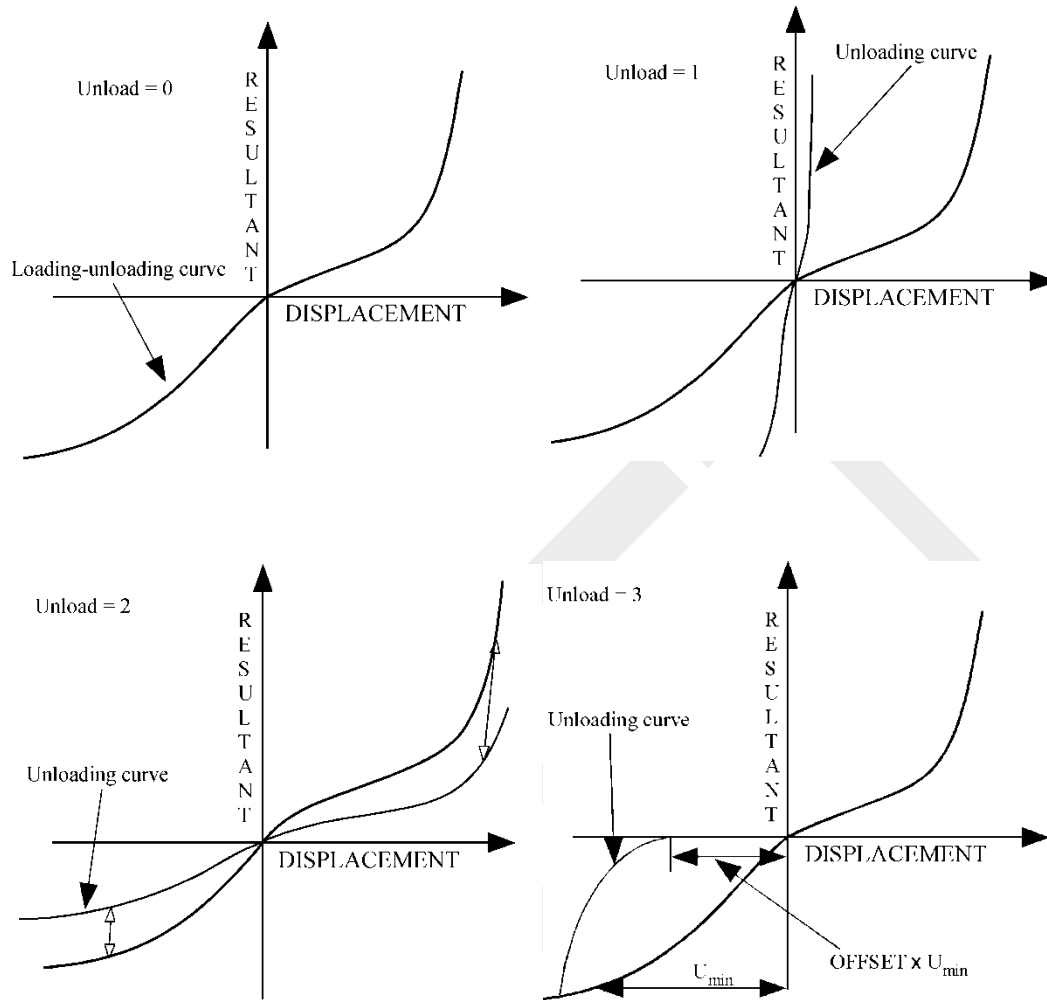

Figure 119.1. Load and unloading behavior.

There are two formulations for calculating the force. The first is the standard displacement formulation, where, for example, the force in a linear spring is

$$F = -K\Delta\ell$$

for a change in length of the beam of  $\Delta\ell$ . The second formulation is based on the linear strain, giving a force of

$$F = -K \frac{\Delta\ell}{\ell_0}$$

for a beam with an initial length of  $\ell_0$ . This option is useful when there are springs of different lengths but otherwise similar construction since it automatically reduces the stiffness of the spring as the length increases, allowing an entire family of springs to be modeled with a single material. Note that all the displacement and velocity components are divided by the initial length, and therefore the scaling applies to the damping and rotational stiffness.

**\*MAT\_GURSON**

This is Material Type 120. This is the Gurson dilatational-plastic model. This model is available for shell and solid elements. A detailed description of this model can be found in the following references: Gurson [1975, 1977], Chu and Needleman [1980] and Tvergaard and Needleman [1984]. The implementation in LS-DYNA is based on the implementation of Feucht [1998] and Faßnacht [1999], which was recoded at LSTC. Strain rate dependency can be defined via a Table definition starting with the second formal release of version 971.

Card 1            1            2            3            4            5            6            7            8

Variable	MID	RO	E	PR	SIGY	N	Q1	Q2
Type	A8	F	F	F	F	F	F	F
Default	none	none	none	none	none	0.0	none	none

Card 2            1            2            3            4            5            6            7            8

Variable	FC	F0	EN	SN	FN	ETAN	ATYP	FF0
Type	F	F	F	F	F	F	F	F
Default	0	0	0	0	0	0	0	0

Card 3            1            2            3            4            5            6            7            8

Variable	EPS1	EPS2	EPS3	EPS4	EPS5	EPS6	EPS7	EPS8
Type	F	F	F	F	F	F	F	F
Default	0	0	0	0	0	0	0	0

Card 4            1            2            3            4            5            6            7            8

Variable	ES1	ES2	ES3	ES4	ES5	ES6	ES7	ES8
Type	F	F	F	F	F	F	F	F
Default	0	0	0	0	0	0	0	0

Card 5            1            2            3            4            5            6            7            8

Variable	L1	L2	L3	L4	FF1	FF2	FF3	FF4
Type	F	F	F	F	F	F	F	F
Default	0	0	0	0	0	0	0	0

Card 6            1            2            3            4            5            6            7            8

Variable	LCSS	LCLF	NUMINT	LCF0	LCFC	LCFN	VG Typ	DEXP
Type	F	F	F	F	F	F	F	F
Default	0	0	1.0	0	0	0	0	3.0

**VARIABLE**

**DESCRIPTION**

- MID            Material identification. A unique number or label not exceeding 8 characters must be specified.
- RO            Mass density.
- E            Young's modulus.
- PR            Poisson's ratio.
- SIGY        Yield stress.

VARIABLE	DESCRIPTION
N	Exponent for Power law. This value is only used if ATYP=1 and LCSS=0.
Q1	Gurson flow function parameter $q_1$ .
Q2	Gurson flow function parameter $q_2$ .
FC	Critical void volume fraction $f_c$ where voids begin to aggregate. This value is only used if LCFC=0.
F0	Initial void volume fraction $f_0$ . This value is only used if LCF0=0.
EN	Mean nucleation strain $\epsilon_N$ .
SN	Standard deviation $s_N$ of the normal distribution of $\epsilon_N$ .
FN	Void volume fraction of nucleating particles $f_N$ . This value is only used if LCFN=0.
ETAN	Hardening modulus. This value is only used if ATYP=2 and LCSS=0.
ATYP	Type of hardening. EQ.1.0: Power law. EQ.2.0: Linear hardening. EQ.3.0: 8 points curve.
FF0	Failure void volume fraction $f_F$ . This value is only used if no curve is given by L1,FF1 – L4,FF4 and LCFF=0.
EPS1-EPS8	Effective plastic strain values. The first point must be zero corresponding to the initial yield stress. At least 2 points should be defined. These values are used if ATYP=3 and LCSS=0.
ES1-ES8	Corresponding yield stress values to EPS1 – EPS8. These values are used if ATYP=3 and LCSS=0.
L1-L4	Element length values. These values are only used if LCFF=0
FF1-FF4	Corresponding failure void volume fraction. These values are only used if LCFF=0.

VARIABLE	DESCRIPTION
LCSS	Load curve ID or Table ID. ATYP is ignored with this option. Load curve ID defining effective stress versus effective plastic strain. Table ID defines for each strain rate value a load curve ID giving the effective stress versus effective plastic strain for that rate (see MAT_024). The stress-strain curve for the lowest value of strain rate is used if the strain rate falls below the minimum value. Likewise, the stress-strain curve for the highest value of strain rate is used if the strain rate exceeds the maximum value. <u>NOTE</u> : The strain rate values defined in the table may be given as the natural logarithm of the strain rate. If the <i>first</i> stress-strain curve in the table corresponds to a negative strain rate, LS-DYNA assumes that the natural logarithm of the strain rate value is used. Since the tables are internally discretized to equally space the points, natural logarithms are necessary, for example, if the curves correspond to rates from 10.e-04 to 10.e+04. The table option is available starting with the second formal release of version 971.
LCFF	Load curve ID defining failure void volume fraction $f_F$ versus element length.
NUMINT	Number of integration points which must fail before the element is deleted. This option is available for shells and solids. LT.0.0:  NUMINT  is percentage of integration points/layers which must fail before shell element fails. For fully integrated shells, a methodology is used where a layer fails if one integration point fails and then the given percentage of layers must fail before the element fails. Only available for shells.
LCF0	Load curve ID defining initial void volume fraction $f_0$ versus element length. This option is available starting with the second formal release of version 971.
LCFC	Load curve ID defining critical void volume fraction $f_c$ versus element length. This option is available starting with the second formal release of version 971.
LCFN	Load curve ID defining void volume fraction of nucleating particles $f_N$ versus element length. This option is available starting with the second formal release of version 971.

VARIABLE	DESCRIPTION
VGTYP	Type of void growth behavior. EQ.0.0: Void growth in case of tension and void contraction in case of compression, but never below $f_0$ (default). EQ.1.0: Void growth only in case of tension. EQ.2.0: Void growth in case of tension and void contraction in case of compression, even below $f_0$ .
DEXP	Exponent value for damage history variable 16.

**Remarks:**

The Gurson flow function is defined as:

$$\Phi = \frac{\sigma_M^2}{\sigma_Y^2} + 2q_1 f^* \cosh\left(\frac{3q_2 \sigma_H}{2\sigma_Y}\right) - 1 - (q_1 f^*)^2 = 0$$

where  $\sigma_M$  is the equivalent von Mises stress,  $\sigma_Y$  is the yield stress,  $\sigma_H$  is the mean hydrostatic stress. The effective void volume fraction is defined as

$$f^*(f) = \begin{cases} f & f \leq f_c \\ f_c + \frac{1/q_1 - f_c}{f_F - f_c} (f - f_c) & f > f_c \end{cases}$$

The growth of void volume fraction is defined as

$$\dot{f} = \dot{f}_G + \dot{f}_N$$

where the growth of existing voids is defined as

$$\dot{f}_G = (1-f) \dot{\epsilon}_{kk}^p$$

and nucleation of new voids is defined as

$$\dot{f}_N = A \dot{\epsilon}_p$$

with function  $A$

$$A = \frac{f_N}{S_N \sqrt{2\pi}} \exp\left(-\frac{1}{2} \left(\frac{\epsilon_p - \epsilon_N}{S_N}\right)^2\right)$$

Voids are nucleated only in tension.



History variables

*Shell / Solid*    *Description*

1 / 1            Void volume fraction

4 / 2            Triaxiality variable  $\sigma_H / \sigma_M$

5 / 3            Effective strain rate

6 / 4            Growth of voids

7 / 5            Nucleation of voids

11 / 11          Dimensionless material damage value =  $\begin{cases} (f - f_0) / (f_c - f_0) & \text{if } f \leq f_c \\ 1 + (f - f_c) / (f_F - f_c) & \text{if } f > f_c \end{cases}$

13 / 13          Deviatoric part of microscopic plastic strain

14 / 14          Volumetric part of macroscopic plastic strain

16 / 16          Dimensionless material damage value =  $\left( \frac{f - f_0}{f_F - f_0} \right)^{1/DEXP}$

**\*MAT\_GURSON\_JC**

This is an enhancement of Material Type 120. This is the Gurson model with additional Johnson-Cook failure criterion (parameters Card 5). This model is available for shell and solid elements. Strain rate dependency can be defined via Table. This model is available starting with the second formal release of version 971. An extension for void growth under shear-dominated states and for Johnson-Cook damage evolution is available starting with the fourth formal release of version 971 (optional Card 7).

Card 1            1            2            3            4            5            6            7            8

Variable	MID	RO	E	PR	SIGY	N	Q1	Q2
Type	A8	F	F	F	F	F	F	F
Default	none	none	none	none	None	0.0	none	none

Card 2            1            2            3            4            5            6            7            8

Variable	FC	F0	EN	SN	FN	ETAN	ATYP	FF0
Type	F	F	F	F	F	F	F	F
Default	0	0	0	0	0	0	0	0

Card 3            1            2            3            4            5            6            7            8

Variable	EPS1	EPS2	EPS3	EPS4	EPS5	EPS6	EPS7	EPS8
Type	F	F	F	F	F	F	F	F
Default	0	0	0	0	0	0	0	0

Card 4            1            2            3            4            5            6            7            8

Variable	SIG1	SIG2	SIG3	SIG4	SIG5	SIG6	SIG7	SIG8
Type	F	F	F	F	F	F	F	F
Default	0	0	0	0	0	0	0	0

Card 5            1            2            3            4            5            6            7            8

Variable	LCDAM	L1	L2	D1	D2	D3	D4	LCJC
Type	F	F	F	F	F	F	F	F
Default	0	0	0	0	0	0	0	0

Card 6            1            2            3            4            5            6            7            8

Variable	LCSS	LCFF	NUMINT	LCF0	LCFC	LCFN	VG Typ	DEXP
Type	F	F	F	F	F	F	F	F
Default	0	0	1	0	0	0	0	3.0

**Optional Card (starting with version 971 release R4)**

Card 7            1            2            3            4            5            6            7            8

Variable	KW	BETA	M					
Type	F	F	F					
Default	0	0	1.0					

VARIABLE	DESCRIPTION
MID	Material identification. A unique number or label not exceeding 8 characters must be specified.
RO	Mass density.
E	Young's modulus.
PR	Poisson's ratio.
SIGY	Yield stress.
N	Exponent for Power law. This value is only used if ATYP=1 and LCSS=0.
Q1	Gurson flow function parameter $q_1$ .
Q2	Gurson flow function parameter $q_2$ .
FC	Critical void volume fraction $f_c$ where voids begin to aggregate.
F0	Initial void volume fraction $f_0$ . This value is only used if LCF0=0.
EN	Mean nucleation strain $\epsilon_N$ .
SN	Standard deviation $s_N$ of the normal distribution of $\epsilon_N$ .
FN	Void volume fraction of nucleating particles $f_N$ . This value is only used if LCFN=0.
ETAN	Hardening modulus. This value is only used if ATYP=2 and LCSS=0.
ATYP	Type of hardening. EQ.1.0: Power law. EQ.2.0: Linear hardening. EQ.3.0: 8 points curve.
FF0	Failure void volume fraction $f_F$ . This value is only used if LCFF=0.
EPS1-EPS8	Effective plastic strain values. The first point must be zero corresponding to the initial yield stress. At least 2 points should be defined. These values are used if ATYP=3 and LCSS=0.
ES1-ES8	Corresponding yield stress values to EPS1 – EPS8. These values are used if ATYP=3 and LCSS=0.

VARIABLE	DESCRIPTION
LCDAM	Load curve defining scaling factor $\Lambda$ versus element length. Scales the Johnson-Cook failure strain (see remarks). If LCDAM=0, no scaling is performed.
L1	Lower triaxiality factor defining failure evolution (Johnson-Cook).
L2	Upper triaxiality factor defining failure evolution (Johnson-Cook).
D1-D4	Johnson-Cook damage parameters.
LCJC	Load curve defining scaling factor for Johnson-Cook failure versus triaxiality (see remarks). If LCJC > 0, parameters D1, D2 and D3 are ignored.
LCSS	Load curve ID or Table ID. ATYP is ignored with this option. Load curve ID defining effective stress versus effective plastic strain. Table ID defines for each strain rate value a load curve ID giving the effective stress versus effective plastic strain for that rate (see MAT_024). The stress-strain curve for the lowest value of strain rate is used if the strain rate falls below the minimum value. Likewise, the stress-strain curve for the highest value of strain rate is used if the strain rate exceeds the maximum value. <b>NOTE:</b> The strain rate values defined in the table may be given as the natural logarithm of the strain rate. If the <i>first</i> stress-strain curve in the table corresponds to a negative strain rate, LS-DYNA assumes that the natural logarithm of the strain rate value is used. Since the tables are internally discretized to equally space the points, natural logarithms are necessary, for example, if the curves correspond to rates from 10.e-04 to 10.e+04.
LCFF	Load curve ID defining failure void volume fraction $f_F$ versus element length.
NUMINT	Number of through thickness integration points which must fail before the element is deleted. This option is available for shells and solids. LT.0.0:  NUMINT  is percentage of integration points/layers which must fail before shell element fails. For fully integrated shells, a methodology is used where a layer fails if one integration point fails and then the given percentage of layers must fail before the element fails. Only available for shells.
LCF0	Load curve ID defining initial void volume fraction $f_0$ versus element length.
LCFC	Load curve ID defining critical void volume fraction $f_c$ versus element length.

VARIABLE	DESCRIPTION
LCFN	Load curve ID defining void volume fraction of nucleating particles $f_N$ versus element length.
VG Typ	Type of void growth behavior. EQ.0.0: Void growth in case of tension and void contraction in case of compression, but never below $f_0$ (default). EQ.1.0: Void growth only in case of tension. EQ.2.0: Void growth in case of tension and void contraction in case of compression, even below $f_0$ .
DEXP	Exponent value for damage history variable 16.
KW	Parameter $k_\omega$ for void growth in shear-dominated states. See remarks.
BETA	Parameter $\beta$ in Lode cosine function. See remarks.
M	Parameter for generalization of Johnson-Cook damage evolution. See remarks.

**Remarks:**

The Gurson flow function is defined as:

$$\Phi = \frac{\sigma_M^2}{\sigma_Y^2} + 2q_1 f^* \cosh\left(\frac{3q_2 \sigma_H}{2\sigma_Y}\right) - 1 - (q_1 f^*)^2 = 0$$

where  $\sigma_M$  is the equivalent von Mises stress,  $\sigma_Y$  is the yield stress,  $\sigma_H$  is the mean hydrostatic stress. The effective void volume fraction is defined as

$$f^*(f) = \begin{cases} f & f \leq f_c \\ f_c + \frac{1/q_1 - f_c}{f_F - f_c} (f - f_c) & f > f_c \end{cases}$$

The growth of void volume fraction is defined as

$$\dot{f} = \dot{f}_G + \dot{f}_N$$

where the growth of existing voids is defined as

$$\dot{f}_G = (1 - f) \dot{\epsilon}_{kk}^p + k_\omega \omega(\boldsymbol{\sigma}) f (1 - f) \dot{\epsilon}_M^p \frac{\sigma_Y}{\sigma_M}$$

The second term is an optional extension for shear failure proposed by Nahshon and Hutchinson [2008] with new parameter  $k_\omega$  (=0 by default), effective plastic strain rate in the matrix  $\dot{\epsilon}_M^{pl}$ , and Lode cosin function  $\omega(\boldsymbol{\sigma})$ :

$$\omega(\boldsymbol{\sigma}) = 1 - \xi^2 - \beta \cdot \xi(1 - \xi), \quad \xi = \cos(3\theta) = \frac{27}{2} \frac{J_3}{\sigma_M^3}$$

with parameter  $\beta$ , Lode angle  $\theta$  and third deviatoric stress invariant  $J_3$ .

Nucleation of new voids is defined as

$$\dot{f}_N = A \dot{\epsilon}_M^{pl}$$

with function  $A$

$$A = \frac{f_N}{S_N \sqrt{2\pi}} \exp\left(-\frac{1}{2} \left(\frac{\epsilon_M^{pl} - \epsilon_N}{S_N}\right)^2\right)$$

Voids are nucleated only in tension.

The Johnson-Cook failure criterion is added in this material model. Based on the triaxiality ratio  $\sigma_H / \sigma_M$  failure is calculated as:

- a)  $\sigma_H / \sigma_M > L_1$  : Gurson model
- b)  $L_1 \geq \sigma_H / \sigma_M \geq L_2$  : Gurson model and Johnson-Cook failure criteria
- c)  $\sigma_H / \sigma_M < L_2$  : Gurson model

Johnson-Cook failure strain is defined as

$$\epsilon_f = \left[ D_1 + D_2 \exp\left(D_3 \frac{\sigma_H}{\sigma_M}\right) \right] (1 + D_4 \ln \dot{\epsilon}) \Lambda$$

where  $D_1$ ,  $D_2$ ,  $D_3$  and  $D_4$  are the Johnson-Cook failure parameters and  $\Lambda$  is a function for including mesh-size dependency. An alternative expression can be used, where the first term of the above equation (including D1, D2 and D3) is replaced by a general function LCJC which depends on triaxiality

$$\epsilon_f = LCJC\left(\frac{\sigma_H}{\sigma_M}\right) (1 + D_4 \ln \dot{\epsilon}) \Lambda$$

The Johnson-Cook damage parameter  $D_f$  is calculated with the following evolution

$$\dot{D}_f = \frac{\dot{\epsilon}^{pl}}{\epsilon_f} \rightarrow D_f = \sum \frac{\Delta \epsilon^{pl}}{\epsilon_f} \begin{cases} < 1 & \text{no failure} \\ \geq 1 & \text{failure} \end{cases}$$

where  $\Delta \epsilon^{pl}$  is the increment in effective plastic strain. A more general (non-linear) damage evolution is possible if  $M > 1$  is chosen:

$$\dot{D}_f = \frac{M}{\epsilon_f} D_f^{(1-\frac{1}{M})} \dot{\epsilon}^{pl}, \quad M \geq 1.0$$

History variables

*Shell / Solid Description*

- 1 / 1 Void volume fraction
- 4 / 2 Triaxiality variable  $\sigma_H / \sigma_M$
- 5 / 3 Effective strain rate
- 6 / 4 Growth of voids
- 7 / 5 Nucleation of voids
- 8 / 6 Johnson-Cook failure strain  $\epsilon_f$
- 9 / 7 Johnson-Cook damage parameter  $D_f$
- 10 / 8 Domain variable:
  - = 0 elastic stress update
  - = 1 region a) Gurson
  - = 2 region b) Gurson + Johnson-Cook
  - = 3 region c) Gurson
- 11 / 11 Dimensionless material damage value =  $\begin{cases} (f - f_0) / (f_c - f_0) & \text{if } f \leq f_c \\ 1 + (f - f_c) / (f_F - f_c) & \text{if } f > f_c \end{cases}$
- 13 / 13 Deviatoric part of microscopic plastic strain
- 14 / 14 Volumetric part of macroscopic plastic strain
- 16 / 16 Dimensionless material damage value =  $\left( \frac{f - f_0}{f_F - f_0} \right)^{1/DEXP}$



\*MAT\_GURSON\_RCDC

This is an enhancement of material Type 120. This is the Gurson model with the Wilkins Rc-Dc [Wilkins, et al., 1977] fracture model added. This model is available for shell and solid elements. A detailed description of this model can be found in the following references: Gurson [1975, 1977]; Chu and Needleman [1980]; and Tvergaard and Needleman [1984].

Card 1            1            2            3            4            5            6            7            8

Variable	MID	RO	E	PR	SIGY	N	Q1	Q2
Type	A8	F	F	F	F	F	F	F
Default	None	none	none	none	none	0.0	none	none

Card 2            1            2            3            4            5            6            7            8

Variable	FC	F0	EN	SN	FN	ETAN	ATYP	FF0
Type	F	F	F	F	F	F	F	F
Default	0	0	0	0	0	0	0	0

Card 3            1            2            3            4            5            6            7            8

Variable	EPS1	EPS2	EPS3	EPS4	EPS5	EPS6	EPS7	EPS8
Type	F	F	F	F	F	F	F	F
Default	0	0	0	0	0	0	0	0

Card 4            1            2            3            4            5            6            7            8

Variable	ES1	ES2	ES3	ES4	ES5	ES6	ES7	ES8
Type	F	F	F	F	F	F	F	F
Default	0	0	0	0	0	0	0	0

Card 5            1            2            3            4            5            6            7            8

Variable	L1	L2	L3	L4	FF1	FF2	FF3	FF4
Type	F	F	F	F	F	F	F	F
Default	0	0	0	0	0	0	0	0

Card 6            1            2            3            4            5            6            7            8

Variable	LCSS	LCLF	NUMINT					
Type	F	F	F					
Default	0	0	1					

Card 7            1            2            3            4            5            6            7            8

Variable	ALPHA	BETA	GAMMA	D0	B	LAMBDA	DS	L
Type	F	F	F	F	F	F	F	F
Default	0	0	0	0	0	0	0	0

VARIABLE	DESCRIPTION
MID	Material identification. A unique number or label not exceeding 8 characters must be specified.
RO	Mass density.
E	Young's modulus.
PR	Poisson's ratio.
SIGY	Yield stress.
N	Exponent for Power law. This value is only used if ATYP=1 and LCSS=0.
Q1	Parameter $q_1$ .
Q1	Parameter $q_2$ .
FC	Critical void volume fraction $f_c$
F0	Initial void volume fraction $f_0$ .
EN	Mean nucleation strain $\varepsilon_N$ .
SN	Standard deviation $S_N$ of the normal distribution of $\varepsilon_N$ .
FN	Void volume fraction of nucleating particles.
ETAN	Hardening modulus. This value is only used if ATYP=2 and LCSS=0.
ATYP	Type of hardening. EQ.1.0: Power law. EQ.2.0: Linear hardening. EQ.3.0: 8 points curve.
FF0	Failure void volume fraction. This value is used if no curve is given by the points L1,FF1 - L4,FF4 and LCLF=0.
EPS1-EPS8	Effective plastic strain values. The first point must be zero corresponding to the initial yield stress. This option is only used if ATYP equal to 3. At least 2 points should be defined. These values are used if ATYP=3 and LCSS=0.
ES1-ES8	Corresponding yield stress values to EPS1 - EPS8. These values are used if ATYP=3 and LCSS=0.

<u>VARIABLE</u>	<u>DESCRIPTION</u>
L1-L4	Element length values. These values are only used if LCLF=0.
FF1-FF4	Corresponding failure void volume fraction. These values are only used if LCLF=0.
LCSS	Load curve ID defining effective stress versus effective plastic strain. ATYP is ignored with this option.
LCLF	Load curve ID defining failure void volume fraction versus element length. The values L1-L4 and FF1-FF4 are ignored with this option.
NUMINT	Number of through thickness integration points which must fail before the element is deleted.
ALPHA	Parameter $\alpha$ . for the Rc-Dc model
BETA	Parameter $\beta$ . for the Rc-Dc model
GAMMA	Parameter $\gamma$ . for the Rc-Dc model
D0	Parameter $D_0$ . for the Rc-Dc model
B	Parameter $b$ . for the Rc-Dc model
LAMBDA	Parameter $\lambda$ . for the Rc-Dc model
DS	Parameter $D_s$ . for the Rc-Dc model
L	Characteristic element length for this material

**Remarks:**

The Gurson flow function is defined as:

$$\Phi = \frac{\sigma_M^2}{\sigma_Y^2} + 2q_1 f^* \cosh\left(\frac{3q_2 \sigma_H}{2\sigma_Y}\right) - 1 - (q_1 f^*)^2 = 0$$

where  $\sigma_M$  is the equivalent von Mises stress,  $\sigma_Y$  is the Yield stress,  $\sigma_H$  is the mean hydrostatic stress. The effective void volume fraction is defined as

$$f^*(f) = \begin{cases} f & f \leq f_c \\ f_c + \frac{1/q_1 - f_c}{f_F - f_c} (f - f_c) & f > f_c \end{cases}$$

The growth of the void volume fraction is defined as

$$\dot{f} = \dot{f}_G + \dot{f}_N$$

where the growth of existing voids is given as:

$$\dot{f}_G = (1-f)\dot{\varepsilon}_{kk}^p,$$

and nucleation of new voids as:

$$\dot{f}_N = A\dot{\varepsilon}_p$$

in which  $A$  is defined as

$$A = \frac{f_N}{S_N\sqrt{2\pi}} \exp\left(-\frac{1}{2}\left(\frac{\varepsilon_p - \varepsilon_N}{S_N}\right)^2\right)$$

The Rc-Dc model is defined as the following:

The damage  $D$  is given by

$$D = \int \omega_1 \omega_2 d\varepsilon^p$$

where  $\varepsilon^p$  is the equivalent plastic strain,

$$\omega_1 = \left(\frac{1}{1 - \gamma\sigma_m}\right)^\alpha$$

is a triaxial stress weighting term and

$$\omega_2 = (2 - A_D)^\beta$$

is a asymmetric strain weighting term.

In the above  $\sigma_m$  is the mean stress and

$$A_D = \max\left(\frac{S_2}{S_3}, \frac{S_2}{S_1}\right)$$

Fracture is initiated when the accumulation of damage is

$$\frac{D}{D_c} > 1$$

where  $D_c$  is the a critical damage given by

$$D_c = D_0 \left( 1 + b |\nabla D|^{\lambda} \right)$$

A fracture fraction

$$F = \frac{D - D_c}{D_s}$$

defines the degradations of the material by the Rc-Dc model.

The characteristic element length is used in the calculation of  $\nabla D$ . Calculation of this factor is only done for element with smaller element length than this value.

**\*MAT\_GENERAL\_NONLINEAR\_1DOF\_DISCRETE\_BEAM**

This is Material Type 121. This is a very general spring and damper model. This beam is based on the MAT\_SPRING\_GENERAL\_NONLINEAR option and is a one-dimensional version of the 6DOF\_DISCRETE\_BEAM above. The forces generated by this model act along a line between the two connected nodal points. Additional unloading options have been included.

Card 1            1            2            3            4            5            6            7            8

Variable	MID	RO	K	UNLDOPT	OFFSET	DAMPF		
Type	A8	F	F	I	F	F		

Card 2            1            2            3            4            5            6            7            8

Variable	LCIDT	LCIDTU	LCIDTD	LCIDTE				
Type	I	I	I	I				

Card 3            1            2            3            4            5            6            7            8

Variable	UTFAIL	UCFAIL	IU					
Type	F	F	F					

<u>VARIABLE</u>	<u>DESCRIPTION</u>
MID	Material identification. A unique number or label not exceeding 8 characters must be specified.
RO	Mass density, see also volume in *SECTION_BEAM definition.
K	Translational stiffness for unloading option 2.0.

<b>VARIABLE</b>	<b>DESCRIPTION</b>
UNLDOPT	Unloading option (Also see Figure 119.1): EQ.0.0: Loading and unloading follow loading curve EQ.1.0: Loading follows loading curve, unloading follows unloading curve. The unloading curve ID if undefined is taken as the loading curve. EQ.2.0: Loading follows loading curve, unloading follows unloading stiffness, K, to the unloading curve. The loading and unloading curves may only intersect at the origin of the axes. EQ.3.0: Quadratic unloading from peak displacement value to a permanent offset.
OFFSET	Offset to determine permanent set upon unloading if the UNLDOPT=3.0. The permanent sets in compression and tension are equal to the product of this offset value and the maximum compressive and tensile displacements, respectively.
DAMPF	Damping factor for stability. Values in the neighborhood of unity are recommended. This damping factor is properly scaled to eliminate time step size dependency. Also, it is active if and only if the local stiffness is defined.
LCIDT	Load curve ID defining translational force resultant along the axis versus relative translational displacement. If zero, no stiffness related forces are generated for this degree of freedom. The loading curves must be defined from the most negative displacement to the most positive displacement. The force does not need to increase monotonically for the loading curve. The curves are extrapolated when the displacement range falls outside the curve definition.
LCIDTU	Load curve ID defining translational force resultant along the axis versus relative translational displacement during unloading. The force values defined by this curve must increase monotonically from the most negative displacement to the most positive displacement. For UNLDOPT=1.0, the slope of this curve must equal or exceed the loading curve for stability reasons. This is not the case for UNLDOPT=2.0. For loading and unloading to follow the same path simply set LCIDTU=LCIDT.
LCIDTD	Load curve ID defining translational damping force resultant along the axis versus relative translational velocity.
LCIDTE	Load curve ID defining translational damping force scale factor versus relative displacement along the axis.
UTFAIL	Optional, translational displacement at failure in tension. If zero, failure in tension is not considered.



---

<u>VARIABLE</u>	<u>DESCRIPTION</u>
UCFAIL	Optional, translational displacement at failure in compression. If zero, failure in compression is not considered.
IU	Initial translational displacement along axis.



**\*MAT\_HILL\_3R**

This is Material Type 122. This is Hill's 1948 planar anisotropic material model with 3 R values.

Card 1            1            2            3            4            5            6            7            8

Variable	MID	RO	E	PR	HR	P1	P2	
Type	A8	F	F	F	F	F	F	

Card 2            1            2            3            4            5            6            7            8

Variable	R00	R45	R90	LCID	E0			
Type	F	F	F	F	F			

Card 3            1            2            3            4            5            6            7            8

Variable	AOPT							
Type	F							

Card 4            1            2            3            4            5            6            7            8

Variable				A1	A2	A3		
Type				F	F	F		

Card 5            1            2            3            4            5            6            7            8

Variable	V1	V2	V3	D1	D2	D3	BETA	
Type	F	F	F	F	F	F	F	

<u>VARIABLE</u>	<u>DESCRIPTION</u>
MID	Material identification. A unique number or label not exceeding 8 characters must be specified.
RO	Mass density.
E	Young's modulus, E
PR	Poisson's ratio, $\nu$
HR	Hardening rule: EQ.1.0: linear (default), EQ.2.0: exponential. EQ.3.0: load curve
P1	Material parameter: HR.EQ.1.0: Tangent modulus, HR.EQ.2.0: k, strength coefficient for exponential hardening
P2	Material parameter: HR.EQ.1.0: Yield stress HR.EQ.2.0: n, exponent
R00	R <sub>00</sub> , Lankford parameter determined from experiments
R45	R <sub>45</sub> , Lankford parameter determined from experiments
R90	R <sub>90</sub> , Lankford parameter determined from experiments
LCID	load curve ID for the load curve hardening rule
E0	$\epsilon_0$ for determining initial yield stress for exponential hardening. (Default=0.0)

<b>VARIABLE</b>	<b>DESCRIPTION</b>
AOPT	Material axes option (see <b>MAT_OPTION TROPIC_ELASTIC</b> for a more complete description): EQ.0.0: locally orthotropic with material axes determined by element nodes 1, 2, and 4, as with <b>*DEFINE_COORDINATE_NODES</b> , and then rotated about the shell element normal by an angle BETA. EQ.2.0: globally orthotropic with material axes determined by vectors defined below, as with <b>*DEFINE_COORDINATE_VECTOR</b> . EQ.3.0: locally orthotropic material axes determined by rotating the material axes about the element normal by an angle, BETA, from a line in the plane of the element defined by the cross product of the vector <b>v</b> with the element normal. LT.0.0: the absolute value of AOPT is a coordinate system ID number (CID on <b>*DEFINE_COORDINATE_NODES</b> , <b>*DEFINE_COORDINATE_SYSTEM</b> or <b>*DEFINE_COORDINATE_VECTOR</b> ). Available in R3 version of 971 and later.
XP YP ZP	Coordinates of point <b>p</b> for AOPT = 1.
A1 A2 A3	Components of vector <b>a</b> for AOPT = 2.
V1 V2 V3	Components of vector <b>v</b> for AOPT = 3.
D1 D2 D3	Components of vector <b>d</b> for AOPT = 2.
BETA	Material angle in degrees for AOPT = 0 and 3, may be overridden on the element card, see <b>*ELEMENT_SHELL_BETA</b> .

**\*MAT\_MODIFIED\_PIECEWISE\_LINEAR\_PLASTICITY\_{OPTION}**

This is Material Type 123. An elasto-plastic material with an arbitrary stress versus strain curve and arbitrary strain rate dependency can be defined. This model is available for shell and solid elements. Another model, MAT\_PIECEWISE\_LINEAR\_PLASTICITY, is similar but lacks the enhanced failure criteria. Failure is based on effective plastic strain, plastic thinning, the major principal in plane strain component, or a minimum time step size. See the discussion under the model description for MAT\_PIECEWISE\_LINEAR\_PLASTICITY if more information is desired.

Available options include:

**<BLANK>**

**RATE**

**RTCL**

The “RATE” option is used to account for rate dependence of plastic thinning failure. The “RTCL” option is used to activate RTCL damage. One additional card is needed with either option.

Card 1            1            2            3            4            5            6            7            8

Variable	MID	RO	E	PR	SIGY	ETAN	FAIL	TDEL
Type	A8	F	F	F	F	F	F	F
Default	none	none	none	none	none	0.0	10.E+20	0

Card 2            1            2            3            4            5            6            7            8

Variable	C	P	LCSS	LCSR	VP	EPSTHIN	EPSMAJ	NUMINT
Type	F	F	F	F	F	F	F	F
Default	0	0	0	0	0	0	0	0

Card 3            1            2            3            4            5            6            7            8

Variable	EPS1	EPS2	EPS3	EPS4	EPS5	EPS6	EPS7	EPS8
Type	F	F	F	F	F	F	F	F
Default	0	0	0	0	0	0	0	0

Card 4            1            2            3            4            5            6            7            8

Variable	ES1	ES2	ES3	ES4	ES5	ES6	ES7	ES8
Type	F	F	F	F	F	F	F	F
Default	0	0	0	0	0	0	0	0

**Card 5 is required if and only if either the RATE or RTCL option is active.**

Card 5            1            2            3            4            5            6            7            8

Variable	LCTSRF	EPS0	TRIAX					
Type	I	F	F					
Default	0	0	0					

<u>VARIABLE</u>	<u>DESCRIPTION</u>
MID	Material identification. A unique number or label not exceeding 8 characters must be specified.
RO	Mass density.
E	Young's modulus.
PR	Poisson's ratio.
SIGY	Yield stress.

VARIABLE	DESCRIPTION
ETAN	Tangent modulus, ignored if (LCSS.GT.0) is defined.
FAIL	<p>Failure flag.</p> <p>LT.0.0: User defined failure subroutine, matusr_24 in dyn21.F, is called to determine failure</p> <p>EQ.0.0: Failure is not considered. This option is recommended if failure is not of interest since many calculations will be saved.</p> <p>GT.0.0: Plastic strain to failure. When the plastic strain reaches this value, the element is deleted from the calculation.</p>
TDEL	Minimum time step size for automatic element deletion.
C	Strain rate parameter, C, see formula below.
P	Strain rate parameter, P, see formula below.
LCSS	<p>Load curve ID or Table ID. Load curve ID defining effective stress versus effective plastic strain. If defined EPS1-EPS8 and ES1-ES8 are ignored. The table ID defines for each strain rate value a load curve ID giving the stress versus effective plastic strain for that rate, See Figure 24.1. The stress versus effective plastic strain curve for the lowest value of strain rate is used if the strain rate falls below the minimum value. Likewise, the stress versus effective plastic strain curve for the highest value of strain rate is used if the strain rate exceeds the maximum value. The strain rate parameters: C and P, the curve ID, LCSR, EPS1-EPS8, and ES1-ES8 are ignored if a Table ID is defined. <u>NOTE</u>: The strain rate values defined in the table may be given as the natural logarithm of the strain rate. If the <i>first</i> stress-strain curve in the table corresponds to a negative strain rate, LS-DYNA assumes that the natural logarithm of the strain rate value is used. Since the tables are internally discretized to equally space the points, natural logarithms are necessary, for example, if the curves correspond to rates from 10.e-04 to 10.e+04. Computing the natural logarithm of the strain rate does slow the stress update down significantly on some computers.</p>
LCSR	Load curve ID defining strain rate scaling effect on yield stress.
VP	<p>Formulation for rate effects:</p> <p>EQ.0.0: Scale yield stress (default),</p> <p>EQ.1.0: Viscoplastic formulation (recommended).</p>
EPSTHIN	Thinning strain at failure. This number should be given as a positive number.

<u>VARIABLE</u>	<u>DESCRIPTION</u>
EPSMAJ	Major in plane strain at failure. LT.0: EPSMAJ= EPSMAJ  and filtering is activated. The last twelve values of the major strain is stored at each integration point and the average value is used to determine failure.
NUMINT	Number of integration points which must fail before the element is deleted. (If zero, all points must fail.) For fully integrated shell formulations, each of the 4*NIP integration points are counted individually in determining a total for failed integration points. NIP is the number of through-thickness integration points. As NUMINT approaches the total number of integration points (NIP for under integrated shells, 4*NIP for fully integrated shells), the chance of instability increases. LT.0.0:  NUMINT  is percentage of integration points/layers which must fail before shell element fails. For fully integrated shells, a methodology is used where a layer fails if one integration point fails and then the given percentage of layers must fail before the element fails. Only available for shells.
EPS1-EPS8	Effective plastic strain values (optional if SIGY is defined). At least 2 points should be defined. The first point must be zero corresponding to the initial yield stress. WARNING: If the first point is nonzero the yield stress is extrapolated to determine the initial yield. If this option is used SIGY and ETAN are ignored and may be input as zero.
ES1-ES8	Corresponding yield stress values to EPS1 - EPS8.
LCTSRF	Load curve that defines the thinning strain at failure as a function of the plastic strain rate.
EPS0	EPS0 parameter for RTCL damage. EQ.0.0: (default) RTCL damage is inactive. GT.0.0: RTCL damage is active
TRIAx	RTCL damage triaxiality limit. EQ.0.0: (default) No limit. GT.0.0: Damage does not accumulate when triaxiality exceeds TRIAX.

**Remarks:**

Optional RTCL damage is used to fail elements when the damage function exceeds 1.0. During each solution cycle, if the plastic strain increment is greater than zero, an increment of RTCL damage is calculated by



$$\Delta f_{damage} = \frac{1}{\varepsilon_0} f\left(\frac{\sigma_H}{\bar{\sigma}}\right)_{RTCL} d\bar{\varepsilon}^p$$

where

$$f\left(\frac{\sigma_H}{\bar{\sigma}}\right)_{RTCL} = \begin{cases} 0 & \text{for } \frac{\sigma_H}{\bar{\sigma}} \leq -\frac{1}{3} \\ 2 \frac{1 + \frac{\sigma_H}{\bar{\sigma}} \sqrt{12 - 27\left(\frac{\sigma_H}{\bar{\sigma}}\right)^2}}{3 \frac{\sigma_H}{\bar{\sigma}} + \sqrt{12 - 27\left(\frac{\sigma_H}{\bar{\sigma}}\right)^2}} & \text{for } -\frac{1}{3} < \frac{\sigma_H}{\bar{\sigma}} < \frac{1}{3} \\ \frac{1}{1.65} \exp\left(\frac{3\sigma_H}{2\bar{\sigma}}\right) & \text{for } \frac{\sigma_H}{\bar{\sigma}} \geq \frac{1}{3} \end{cases}$$

$\varepsilon_0$  = uniaxial fracture strain / critical damage value

$\sigma_H$  = hydrostatic stress

$\bar{\sigma}$  = effective stress

$d\bar{\varepsilon}^p$  = effective plastic strain increment

The increments are summed through time and the element is deleted when  $f_{damage} \geq 1.0$ . For  $0.0 < f_{damage} < 1.0$ , the element strength will not be degraded.

The value of  $f_{damage}$  is stored as the 9<sup>th</sup> extra history variable and can be fringe plotted from d3plot files if the number of extra history variables requested is  $\geq 9$  on \*DATABASE\_EXTENT\_BINARY. If however NUMINT < 0, then the value of  $f_{damage}$  is stored as the 10<sup>th</sup> extra history variable.

The optional TRIAX parameter can be used to prevent excessive RTCL damage growth and element erosion for badly shaped elements that might show unrealistic high values for the triaxiality.

**\*MAT\_PLASTICITY\_COMPRESSION\_TENSION**

This is Material Type 124. An isotropic elastic-plastic material where unique yield stress versus plastic strain curves can be defined for compression and tension. Also, failure can occur based on a plastic strain or a minimum time step size. Rate effects on the yield stress are modeled either by using the Cowper-Symonds strain rate model or by using two load curves that scale the yield stress values in compression and tension, respectively. Material rate effects, which are independent of the plasticity model, are based on a 6-term Prony series Maxwell mode that generates an additional stress tensor. The viscous stress tensor is superimposed on the stress tensor generated by the plasticity.

Card 1            1            2            3            4            5            6            7            8

Variable	MID	RO	E	PR	C	P	FAIL	TDEL
Type	A8	F	F	F	F	F	F	F
Default	none	none	none	none	0	0	10.E+20	0

Card 2            1            2            3            4            5            6            7            8

Variable	LCIDC	LCIDT	LCSRC	LCSRT	SRFLAG	LCFAIL	EC	RPCT
Type	I	I	I	I	F	I	F	F
Default	0	0	0	0	0	0	none	0

Card 3            1            2            3            4            5            6            7            8

Variable	PC	PT	PCUTC	PCUTT	PCUTF			
Type	F	F	F	F	F			
Default	0	0	0	0	0			

Card 4            1            2            3            4            5            6            7            8

Variable	K							
Type	F							

**Card Format for viscoelastic constants. Up to 6 cards may be input. A keyword card (with a "\*" in column 1) terminates this input if less than 6 cards are used.**

Cards opt.        1            2            3            4            5            6            7            8

Variable	GI	BETAI						
Type	F	F						

<u>VARIABLE</u>	<u>DESCRIPTION</u>
MID	Material identification. A unique number or label not exceeding 8 characters must be specified.
RO	Mass density.
E	Young's modulus.
PR	Poisson's ratio.
C	Strain rate parameter, C, see formula below.
P	Strain rate parameter, P, see formula below.
FAIL	Failure flag. LT.0.0: User defined failure subroutine, matusr_24 in dyn21.F, is called to determine failure EQ.0.0: Failure is not considered. This option is recommended if failure is not of interest since many calculations will be saved. GT.0.0: Plastic strain to failure. When the plastic strain reaches this value, the element is deleted from the calculation.
TDEL	Minimum time step size for automatic element deletion.
LCIDC	Load curve ID defining yield stress versus effective plastic strain in compression.

<b>VARIABLE</b>	<b>DESCRIPTION</b>
LCIDT	Load curve ID defining yield stress versus effective plastic strain in tension.
LCSRC	Optional load curve ID defining strain rate scaling effect on yield stress when the material is in compression.
LCSRT	Optional load curve ID defining strain rate scaling effect on yield stress when the material is in tension.
SRFLAG	Formulation for rate effects: EQ.0.0: Total strain rate, EQ.1.0: Deviatoric strain rate. EQ.2.0: Plastic strain rate (viscoplastic).
LCFAIL	Load curve ID defining failure strain versus strain rate.
EC	Optional Young's modulus for compression, >0.
RPCT	Ratio of PC and PT, used to define mean stress at which Young's modulus is E or EC. Young's modulus is E when mean stress >RPCT*PT, and EC when mean stress <-RPCT*PC. If the mean stress falls between -RPCT*PC and RPCT*PT, a linearly interpolated value is used.
PC	Compressive mean stress (pressure) at which the yield stress follows load curve ID, LCIDC. If the pressure falls between PC and PT a weighted average of the two load curves is used.
PT	Tensile mean stress at which the yield stress follows load curve ID, LCIDT.
PCUTC	Pressure cut-off in compression (PCUTC must be greater than or equal to zero). This option applies only to solid elements. When the pressure cut-off is reached the deviatoric stress tensor is set to zero and the pressure remains at its compressive value. Like the yield stress, PCUTC is scaled to account for rate effects.
PCUTT	Pressure cut-off in tension (PCUTT must be less than or equal to zero). This option applies only to solid elements. When the pressure cut-off is reached the deviatoric stress tensor and tensile pressure is set to zero. Like the yield stress, PCUTT is scaled to account for rate effects.
PCUTF	Pressure cut-off flag activation. EQ.0.0: Inactive, EQ.1.0: Active.

<u>VARIABLE</u>	<u>DESCRIPTION</u>
K	Optional bulk modulus for the viscoelastic material. If nonzero a Kelvin type behavior will be obtained. Generally, K is set to zero.
GI	Optional shear relaxation modulus for the ith term
BETAI	Optional shear decay constant for the ith term

**Remarks:**

The stress strain behavior follows a different curve in compression than it does in tension. Tension is determined by the sign of the mean stress where a positive mean stress (i.e., a negative pressure) is indicative of tension. Two curves must be defined giving the yield stress versus effective plastic strain for both the tension and compression regimes.

Mean stress is an invariant which can be expressed as  $(\sigma_x + \sigma_y + \sigma_z)/3$ . PC and PT define a range of mean stress values within which interpolation is done between the tensile yield surface and compressive yield surface. PC and PT are not true material properties but are just a numerical convenience so that the transition from one yield surface to the other is not abrupt as the sign of the mean stress changes. Both PC and PT are input as positive values as it is implied that PC is a compressive mean stress value and PT is tensile mean stress value.

Strain rate may be accounted for using the Cowper and Symonds model which scales the yield stress with the factor:

$$1 + \left(\frac{\dot{\epsilon}}{C}\right)^{1/p}$$

where  $\dot{\epsilon}$  is the strain rate.  $\dot{\epsilon} = \sqrt{\dot{\epsilon}_{ij}\dot{\epsilon}_{ij}}$ .

# \*MAT\_125\*MAT\_KINEMATIC\_HARDENING\_TRANSVERSELY\_ANISOTROPIC

## \*MAT\_KINEMATIC\_HARDENING\_TRANSVERSELY\_ANISOTROPIC

This is Material Type 125. This material model combines Yoshida's non-linear kinematic hardening rule with material type 37. Yoshida's theory uses two surfaces to describe the hardening rule: the yield surface and the bounding surface. In the forming process, the yield surface does not change in size, but its center translates with deformation; the bounding surface changes both in size and location. This model allows the change of Young's modulus as a function of effective plastic strain as proposed by Yoshida [2003]. This material type is available for shells, thick shells and solid elements.

Card 1            1            2            3            4            5            6            7            8

Variable	MID	RO	E	PR	R	HCLID	OPT	
Type	A8	F	F	F	F	I	I	
Default	none	none	none	none	none	none	none	

Card 2            1            2            3            4            5            6            7            8

Variable	CB	Y	SC	K	RSAT	SB	H	
Type	F	F	F	F	F	F	F	
Default	none	none	none	none	none	none	none	

Card 3            1            2            3            4            5            6            7            8

Variable	EA	COE	IOPT	C1	C2			
Type	F	F	I	F	F			
Default	none	none	0	none	none			

## \*MAT\_KINEMATIC\_HARDENING\_TRANSVERSELY\_ANISOTROPIC\***MAT\_125**

<u>VARIABLE</u>	<u>DESCRIPTION</u>
MID	Material identification. A unique number or label not exceeding 8 characters must be specified.
RO	Mass density.
E	Young's Modulus
PR	Poisson's ratio
R	Anisotropic hardening parameter
HLCID	Load curve ID in keyword *DEFINE_CURVE, where true strain and true stress relationship is characterized. This curve is used in conjunction with variable OPT, and not to be referenced or used in other keywords.
OPT	Error calculation flag. When OPT=2, the load curve ID is the true stress-strain curve from uniaxial tension. LS-DYNA will perform error calculation based on this curve.
CB	The uppercase B defined in the following equations.
Y	Hardening parameter as defined in the following equations.
SC	The lowercase c defined in the following equations.
K	Hardening parameter as defined in the following equations.
RSAT	Hardening parameter as defined in the following equations.
SB	The lowercase b as defined in the following equations.
H	Anisotropic parameter associated with work-hardening stagnation.
EA	Variable controlling the change of Young's modulus, $E^A$ in the following equations.
COE	Variable controlling the change of Young's modulus, $\zeta$ in the following equations.
IOPT	Modified kinematic hardening rule flag: EQ.0: Original Yoshida formulation, EQ.1: Modified formulation. Define C1, C2 below.
C1, C2	Constants used to modify R: $R = RSAT \left[ (C_1 + \bar{\epsilon}^p)^{c_2} - C_1^{c_2} \right]$

**Remarks:**

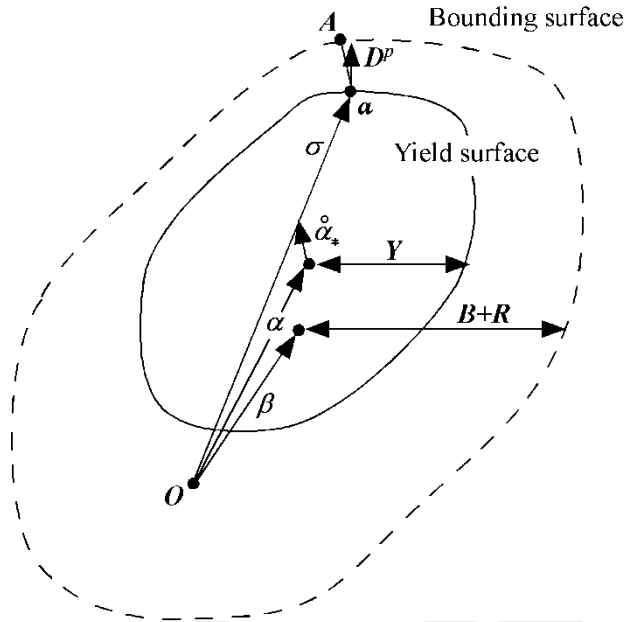

**Figure 125.1** Schematic illustration of the two-surface model

1. The above figure is a schematic illustration of the two-surface kinematic model. O is the original center of the yield surface,  $\alpha_*$  is the current center for the yield surface;  $\alpha$  is the center of the bounding surface.  $\beta$  represents the relative position of the centers of the two surfaces. Y is the size of the yield surface and is constant throughout the deformation process. B+R represents the size of the bounding surface, with R being associated with isotropic hardening.

$$\alpha_* = \alpha - \beta$$

$$\alpha_* = c \left[ \left( \frac{a}{Y} \right) (\sigma - \alpha) - \sqrt{\frac{a}{\alpha_*}} \alpha_* \right] \bar{\epsilon}^p$$

$$a = B + R - Y$$

The change of size and location for the bounding surface is defined as

$$\dot{R} = k(R_{sat} - R)\dot{\bar{\epsilon}}^p,$$

$$\dot{\beta}' = k \left( \frac{2}{3} bD - \beta' \dot{\bar{\epsilon}}^p \right)$$

$$\sigma_{bound} = B + R + \beta$$



In Yoshida’s model, this is work-hardening stagnation in the unloading process, and it is described as:

$$g_{\sigma}(\sigma', q', r') = \frac{3}{2}(\sigma' - q') : (\sigma' - q') - r'^2$$

$$\dot{q}' = \mu(\beta' - q')$$

$$r = h\Gamma, \Gamma = \frac{3(\beta' - q') : \beta'}{2r}$$

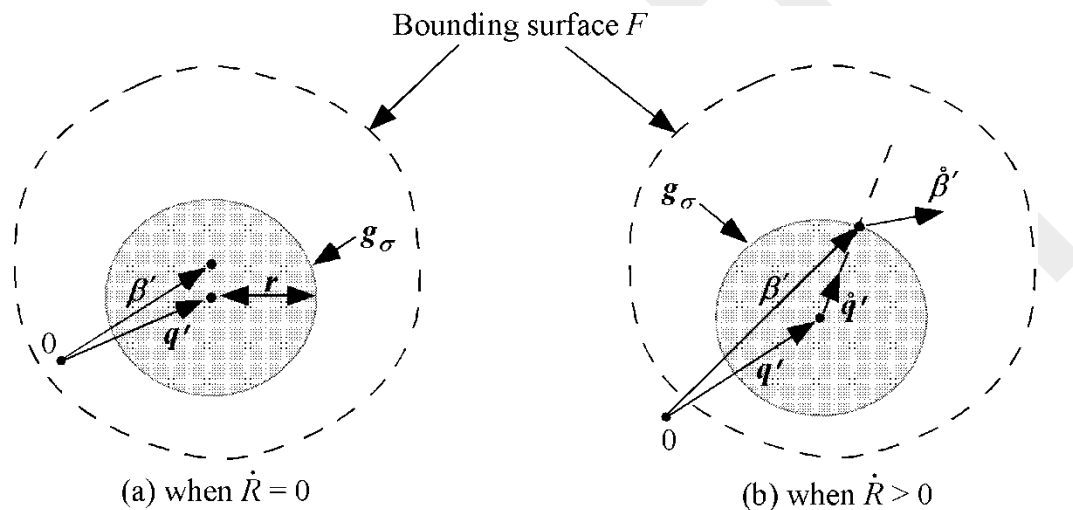

Young’s modulus is defined as a function of effective strain:

$$E = E_0 - (E_0 - E_A)(1 - \exp(-\zeta \bar{\epsilon}^p))$$

- Further improvements in the original Yoshida’s model, as described in a paper “*Determination of Nonlinear Isotropic/Kinematic Hardening Constitutive Parameter for AHSS using Tension and Compression Tests*”, by Ming F. Shi, Xinhai Zhu, Cedric Xia, Thomas Stoughton, in *NUMISHEET 2008 proceedings*, 137-142, 2008, included modifications to allow working hardening in large strain deformation region, avoiding the problem of earlier saturation, especially for Advanced High Strength Steel (AHSS). These types of steels exhibit continuous strain hardening behavior and a non-saturated isotropic hardening function. As described in the paper, the evolution equation for  $R$  (a part of the current radius of the bounding surface in deviatoric stress space), as is with the saturation type of isotropic hardening rule proposed in the original Yoshida model,

$$\dot{R} = m(R_{sat} - R)\dot{p}$$

is modified as,

## \*MAT\_125\* \*MAT\_KINEMATIC\_HARDENING\_TRANSVERSELY\_ANISOTROPIC

$$R = RSAT \left[ (C_1 + \bar{\epsilon}^p)^{c_2} - C_1^{c_2} \right]$$

For saturation type of isotropic hardening rule, set IOPT=0, applicable to most of Aluminum sheet materials. In addition, the paper provides detailed variables used for this material model for DDQ, HSLA, DP600, DP780 and DP980 materials. Since the symbols used in the paper are different from what are used here, the following table provides a reference between symbols used in the paper and variables here in this keyword:

B	Y	C	m	K	b	h	e <sup>0</sup>	N
CB	Y	SC	K	Rsat	SB	H	C1	C2

Using the modified formulation and the material properties provided by the paper, the predicted and tested results compare very well both in a full cycle tension and compression test and in a pre-strained tension and compression test, according to the paper.

Application of the modified Yoshida's hardening rule in the metal forming industry has shown significant improvement in springback prediction accuracy, especially for AHSS type of sheet materials. In the figure shown below, predicted springback shape with \*MAT\_125 is compared with experimental measurements of a DP780 material. Prediction accuracy achieved over 92% with \*MAT\_125 while about 61% correlation is found with \*MAT\_037.

3. To improve convergence, it is recommended that \*CONTROL\_IMPLICIT\_FORMING type '1' be used when conducting a springback simulation.
4. The HCLID, OPT, IOPT, C1, and C2 variables are available in LS-DYNA R4 Revision 46217 or later releases.

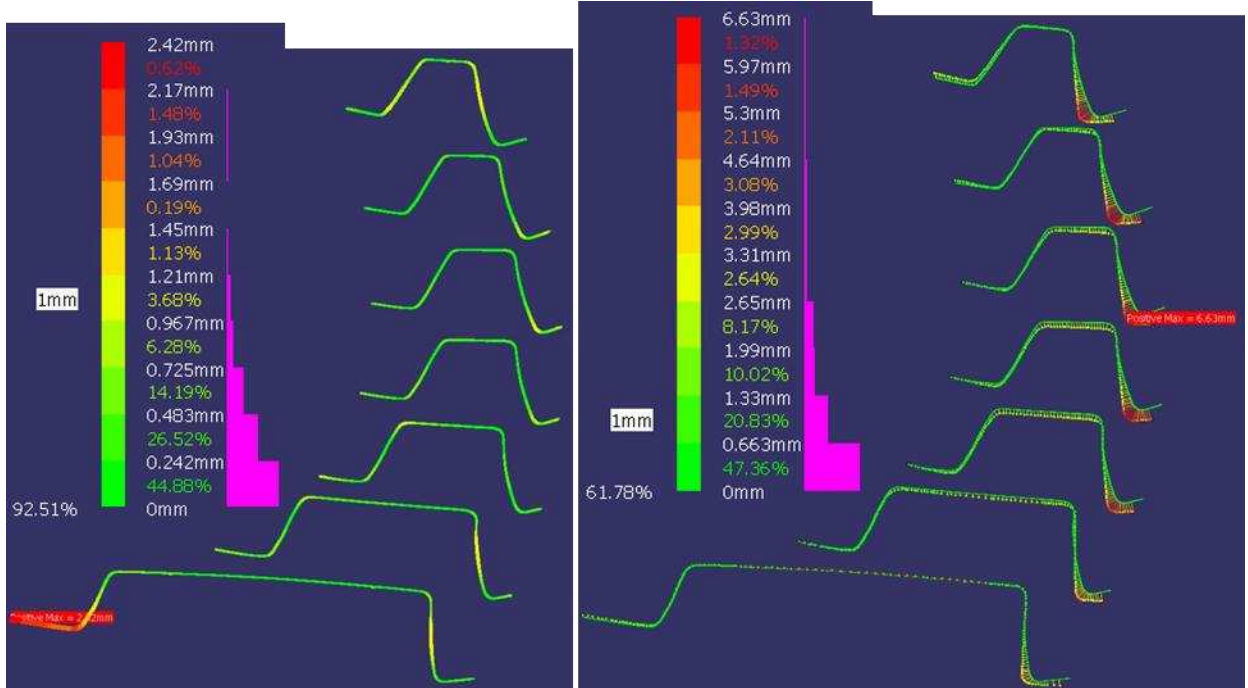

*Courtesy of Chrysler LLC and United States Steel Corporation.*

**\*MAT\_MODIFIED\_HONEYCOMB**

This is Material Type 126. The major use of this material model is for aluminum honeycomb crushable foam materials with anisotropic behavior. Three yield surfaces are available. In the first, nonlinear elastoplastic material behavior can be defined separately for all normal and shear stresses, which are considered to be fully uncoupled. In the second, a yield surface is defined that considers the effects of off-axis loading. The second yield surface is transversely isotropic. A drawback of this second yield surface is that the material can collapse in a shear mode due to low shear resistance. There was no obvious way of increasing the shear resistance without changing the behavior in purely uniaxial compression. Therefore, in the third option, the model has been modified so that the user can prescribe the shear and hydrostatic resistance in the material without affecting the uniaxial behavior. The choice of the second yield surface is flagged by the sign of the first load curve ID, LCA. The third yield surface is flagged by the sign of ECCU, which becomes the initial stress yield limit in simple shear. A description is given below.

The development of the second and third yield surfaces are based on experimental test results of aluminum honeycomb specimens at Toyota Motor Corporation.

The default element for this material is solid type 0, a nonlinear spring type brick element. *The recommended hourglass control is the type 2 viscous formulation for one point integrated solid elements. The stiffness form of the hourglass control when used with this constitutive model can lead to nonphysical results since strain localization in the shear modes can be inhibited.*

Card 1            1            2            3            4            5            6            7            8

Variable	MID	RO	E	PR	SIGY	VF	MU	BULK
Type	A8	F	F	F	F	F	F	F
Default	none	None	None	none	none	none	.05	0.0

Card 2            1            2            3            4            5            6            7            8

Variable	LCA	LCB	LCC	LCS	LCAB	LCBC	LCCA	LCSR
Type	F	F	F	F	F	F	F	F
Default	none	LCA	LCA	LCA	LCS	LCS	LCS	optional

Card 3            1            2            3            4            5            6            7            8

Variable	EAAU	EBBU	ECCU	GABU	GBCU	GCAU	AOPT	MACF
Type	F	F	F	F	F	F		I

Card 4            1            2            3            4            5            6            7            8

Variable	XP	YP	ZP	A1	A2	A3		
Type	F	F	F	F	F	F		

Card 5            1            2            3            4            5            6            7            8

Variable	D1	D2	D3	TSEF	SSEF	VREF	TREF	SHDFLG
Type	F	F	F	F	F	F	F	F

**Define if and only if LCSR=-1.0**

Card 6            1            2            3            4            5            6            7            8

Variable	LCSRA	LCSR B	LCSRC	LCSRAB	LCSRBC	LCSCA		
Type	F	F	F	F	F	F		

**Define if and only if AOPT=3 or AOPT=4**

Card 6            1            2            3            4            5            6            7            8

Variable	V1	V2	V3					
Type	F	F	F					

VARIABLE	DESCRIPTION
MID	Material identification. A unique number or label not exceeding 8 characters must be specified.
RO	Mass density.
E	Young's modulus for compacted honeycomb material.
PR	Poisson's ratio for compacted honeycomb material.
SIGY	Yield stress for fully compacted honeycomb.
VF	Relative volume at which the honeycomb is fully compacted. This parameter is ignored for corotational solid elements, types 0 and 9.
MU	$\mu$ , material viscosity coefficient. (default=.05) Recommended.
BULK	Bulk viscosity flag: EQ.0.0: bulk viscosity is not used. This is recommended. EQ.1.0: bulk viscosity is active and $\mu=0$ This will give results identical to previous versions of LS-DYNA.
LCA	Load curve ID, see *DEFINE_CURVE: LCA.LT.0: Yield stress as a function of the angle off the material axis in degrees. LCA.GT.0: sigma-aa versus normal strain component aa. For the corotational solid elements, types 0 and 9, engineering strain is expected, but for all other solid element formulations a logarithmic strain is expected. See Remarks.
LCB	Load curve ID, see *DEFINE_CURVE: LCA.LT.0: strong axis hardening stress as a function of the volumetric strain. LCA.GT.0: sigma-bb versus normal strain component bb. For the corotational solid elements, types 0 and 9, engineering strain is expected, but for all other solid element formulations a logarithmic strain is expected. Default LCB=LCA. See Remarks.
LCC	Load curve ID, see *DEFINE_CURVE: LCA.LT.0: weak axis hardening stress as a function of the volumetric strain. LCA.GT.0: sigma-cc versus normal strain component cc. For the corotational solid elements, types 0 and 9, engineering strain is expected, but for all other solid element formulations a logarithmic strain is expected. Default LCC=LCA. See Remarks.

VARIABLE	DESCRIPTION
LCS	<p>Load curve ID, see *DEFINE_CURVE:</p> <p>LCA.LT.0: damage curve giving shear stress multiplier as a function of the shear strain component. This curve definition is optional and may be used if damage is desired. IF SHDFLG=0 (the default), the damage value multiplies the stress every time step and the stress is updated incrementally. The damage curve should be set to unity until failure begins. After failure the value should drop to 0.999 or 0.99 or any number between zero and one depending on how many steps are needed to zero the stress. Alternatively, if SHDFLG=1, the damage value is treated as a factor that scales the shear stress compared to the undamaged value.</p> <p>LCA.GT.0: shear stress versus shear strain. For the corotational solid elements, types 0 and 9, engineering strain is expected, but for all other solid element formulations a shear strain based on the deformed configuration is used. Default LCS=LCA. Each component of shear stress may have its own load curve. See Remarks.</p>
LCAB	<p>Load curve ID, see *DEFINE_CURVE. Default LCAB=LCS:</p> <p>LCA.LT.0: damage curve giving shear ab-stress multiplier as a function of the ab-shear strain component. This curve definition is optional and may be used if damage is desired. See LCS above.</p> <p>LCA.GT.0: sigma-ab versus shear strain-ab. For the corotational solid elements, types 0 and 9, engineering strain is expected, but for all other solid element formulations a shear strain based on the deformed configuration is used. See Remarks.</p>
LCBC	<p>Load curve ID, see *DEFINE_CURVE. Default LCBC=LCS:</p> <p>LCA.LT.0: damage curve giving bc-shear stress multiplier as a function of the ab-shear strain component. This curve definition is optional and may be used if damage is desired. See LCS above.</p> <p>LCA.GT.0: sigma-bc versus shear strain-bc. For the corotational solid elements, types 0 and 9, engineering strain is expected, but for all other solid element formulations a shear strain based on the deformed configuration is used. See Remarks.</p>
LCCA	<p>Load curve ID, see *DEFINE_CURVE. Default LCCA=LCS:</p> <p>LCA.LT.0: damage curve giving ca-shear stress multiplier as a function of the ca-shear strain component. This curve definition is optional and may be used if damage is desired. See LCS above.</p> <p>LCA.GT.0: sigma-ca versus shear strain-ca. For the corotational solid elements, types 0 and 9, engineering strain is expected, but for all other solid element formulations a shear strain based on the deformed configuration is used. See Remarks.</p>

<u>VARIABLE</u>	<u>DESCRIPTION</u>
LCSR	Load curve ID, see *DEFINE_CURVE, for strain-rate effects defining the scale factor versus effective strain rate $\dot{\epsilon} = \sqrt{\frac{2}{3}(\dot{\epsilon}'_{ij}\dot{\epsilon}'_{ij})}$ . This is optional. The curves defined above are scaled using this curve.
EAAU	Elastic modulus $E_{aaU}$ in uncompressed configuration.
EBBU	Elastic modulus $E_{bbU}$ in uncompressed configuration.
ECCU	Elastic modulus $E_{ccU}$ in uncompressed configuration. LT.0.0: $\sigma_d^Y$ ,  ECCU  initial stress limit (yield) in simple shear. Also, LCA<0 to activate the transversely isotropic yield surface.
GABU	Shear modulus $G_{abU}$ in uncompressed configuration.
GBCU	Shear modulus $G_{bcU}$ in uncompressed configuration.
GCAU	Shear modulus $G_{caU}$ in uncompressed configuration. ECCU.LT.0.0: $\sigma_p^Y$ , GCAU initial stress limit (yield) in hydrostatic compression. Also, LCA<0 to activate the transversely isotropic yield surface.



VARIABLE	DESCRIPTION
AOPT	<p>Material axes option (see <i>MAT_OPTION</i> TROPIC_ELASTIC for a more complete description):</p> <p>EQ.0.0: locally orthotropic with material axes determined by element nodes 1, 2, and 4, as with *DEFINE_COORDINATE_NODES.</p> <p>EQ.1.0: locally orthotropic with material axes determined by a point in space and the global location of the element center; this is the a-direction.</p> <p>EQ.2.0: globally orthotropic with material axes determined by vectors defined below, as with *DEFINE_COORDINATE_VECTOR.</p> <p>EQ.3.0: locally orthotropic material axes determined by rotating the material axes about the element normal by an angle, BETA, from a line in the plane of the element defined by the cross product of the vector <b>v</b> with the element normal. The plane of a solid element is the midsurface between the inner surface and outer surface defined by the first four nodes and the last four nodes of the connectivity of the element, respectively.</p> <p>EQ.4.0: locally orthotropic in cylindrical coordinate system with the material axes determined by a vector <b>v</b>, and an originating point, <b>P</b>, which define the centerline axis. This option is for solid elements only.</p> <p>LT.0.0: the absolute value of AOPT is a coordinate system ID number (CID on *DEFINE_COORDINATE_NODES, *DEFINE_COORDINATE_SYSTEM or *DEFINE_COORDINATE_VECTOR). Available starting with the R3 release of Version 971.</p>
MACF	<p>Material axes change flag:</p> <p>EQ.1: No change, default,</p> <p>EQ.2: switch material axes a and b,</p> <p>EQ.3: switch material axes a and c,</p> <p>EQ.4: switch material axes b and c.</p>
XP YP ZP	Coordinates of point <b>p</b> for AOPT = 1.
A1 A2 A3	Components of vector <b>a</b> for AOPT = 2.
D1 D2 D3	Components of vector <b>d</b> for AOPT = 2.
V1 V2 V3	Define components of vector <b>v</b> for AOPT = 3 and 4.
TSEF	Tensile strain at element failure (element will erode).
SSEF	Shear strain at element failure (element will erode).

<u>VARIABLE</u>	<u>DESCRIPTION</u>
VREF	This is an optional input parameter for solid elements types 1, 2, 3, 4, and 10. Relative volume at which the reference geometry is stored. At this time the element behaves like a nonlinear spring. The TREF, below, is reached first then VREF will have no effect.
TREF	This is an optional input parameter for solid elements types 1, 2, 3, 4, and 10. Element time step size at which the reference geometry is stored. When this time step size is reached the element behaves like a nonlinear spring. If VREF, above, is reached first then TREF will have no effect.
SHDFLG	Flag defining treatment of damage from curves LCS, LCAB, LCBC and LCCA (relevant only when LCA < 0): EQ.0.0: Damage reduces shear stress every time step, EQ.1.0: Damage = (shear stress)/(undamaged shear stress)
LCSRA	Optional load curve ID if LCSR=-1, see *DEFINE_CURVE, for strain rate effects defining the scale factor for the yield stress in the <i>a</i> -direction versus the <i>natural logarithm</i> of the absolute value of deviatoric strain rate in the <i>a</i> -direction. This curve is optional. The scale factor for the lowest value of strain rate defined by the curve is used if the strain rate is zero. The scale factor for the highest value of strain rate defined by the curve also defines the upper limit of the scale factor.
LCSRB	Optional load curve ID if LCSR=-1, see *DEFINE_CURVE, for strain rate effects defining the scale factor for the yield stress in the <i>b</i> -direction versus the <i>natural logarithm</i> of the absolute value of deviatoric strain
LCSRC	Similar definition as for LCSA and LCSB above.
LCSRAB	Similar definition as for LCSA and LCSB above.
LCSRBC	Similar definition as for LCSA and LCSB above.
LCSRCA	Similar definition as for LCSA and LCSB above.

**Remarks:**

For efficiency it is strongly recommended that the load curve ID's: LCA, LCB, LCC, LCS, LCAB, LCBC, and LCCA, contain exactly the same number of points with corresponding strain values on the abscissa. If this recommendation is followed the cost of the table lookup is insignificant. Conversely, the cost increases significantly if the abscissa strain values are not consistent between load curves.

For solid element formulations 1 and 2, the behavior before compaction is orthotropic where the components of the stress tensor are uncoupled, i.e., an a component of strain will generate resistance in the local  $a$ -direction with no coupling to the local  $b$  and  $c$  directions. The elastic moduli vary from their initial values to the fully compacted values linearly with the relative volume:

$$\begin{aligned} E_{aa} &= E_{aa0} + \beta(E - E_{aa0}) & G_{ab} &= G_{ab0} + \beta(G - G_{ab0}) \\ E_{bb} &= E_{bb0} + \beta(E - E_{bb0}) & G_{bc} &= G_{bc0} + \beta(G - G_{bc0}) \\ E_{cc} &= E_{cc0} + \beta(E - E_{cc0}) & G_{ca} &= G_{ca0} + \beta(G - G_{ca0}) \end{aligned}$$

where

$$\beta = \max \left[ \min \left( \frac{1-V}{1-V_f}, 1 \right), 0 \right]$$

and  $G$  is the elastic shear modulus for the fully compacted honeycomb material

$$G = \frac{E}{2(1+\nu)}$$

The relative volume,  $V$ , is defined as the ratio of the current volume over the initial volume, and typically,  $V=1$  at the beginning of a calculation.

For corotational solid elements, types 0 and 9, the components of the stress tensor remain uncoupled and the uncompressed elastic moduli are used, that is, the fully compacted elastic moduli are ignored.

The load curves define the magnitude of the stress as the material undergoes deformation. The first value in the curve should be less than or equal to zero corresponding to tension and increase to full compaction. **Care should be taken when defining the curves so the extrapolated values do not lead to negative yield stresses.**

At the beginning of the stress update we transform each element's stresses and strain rates into the local element coordinate system. For the uncompacted material, the trial stress components are updated using the elastic interpolated moduli according to:

$$\begin{aligned} \sigma_{aa}^{n+1^{trial}} &= \sigma_{aa}^n + E_{aa} \Delta \varepsilon_{aa} & \sigma_{ab}^{n+1^{trial}} &= \sigma_{ab}^n + 2G_{ab} \Delta \varepsilon_{ab} \\ \sigma_{bb}^{n+1^{trial}} &= \sigma_{bb}^n + E_{bb} \Delta \varepsilon_{bb} & \sigma_{bc}^{n+1^{trial}} &= \sigma_{bc}^n + 2G_{bc} \Delta \varepsilon_{bc} \\ \sigma_{cc}^{n+1^{trial}} &= \sigma_{cc}^n + E_{cc} \Delta \varepsilon_{cc} & \sigma_{ca}^{n+1^{trial}} &= \sigma_{ca}^n + 2G_{ca} \Delta \varepsilon_{ca} \end{aligned}$$

If  $LCA > 0$ , each component of the updated stress tensor is checked to ensure that it does not exceed the permissible value determined from the load curves, e.g., if

$$|\sigma_{ij}^{n+1^{trial}}| > \lambda \sigma_{ij}(\epsilon_{ij})$$

then

$$\sigma_{ij}^{n+1} = \sigma_{ij}(\epsilon_{ij}) \frac{\lambda \sigma_{ij}^{n+1^{trial}}}{|\sigma_{ij}^{n+1^{trial}}|}$$

On Card 3  $\sigma_{ij}(\epsilon_{ij})$  is defined in the load curve specified in columns 31-40 for the aa stress component, 41-50 for the bb component, 51-60 for the cc component, and 61-70 for the ab, bc, cb shear stress components. The parameter  $\lambda$  is either unity or a value taken from the load curve number, LCSR, that defines  $\lambda$  as a function of strain-rate. Strain-rate is defined here as the Euclidean norm of the deviatoric strain-rate tensor.

If  $LCA < 0$ , a transversely isotropic yield surface is obtained where the uniaxial limit stress,  $\sigma^y(\varphi, \epsilon^{vol})$ , can be defined as a function of angle  $\varphi$  with the strong axis and volumetric strain,  $\epsilon^{vol}$ . In order to facilitate the input of data to such a limit stress surface, the limit stress is written as:

$$\sigma^y(\varphi, \epsilon^{vol}) = \sigma^b(\varphi) + (\cos \varphi)^2 \sigma^s(\epsilon^{vol}) + (\sin \varphi)^2 \sigma^w(\epsilon^{vol})$$

where the functions  $\sigma^b$ ,  $\sigma^s$ , and  $\sigma^w$  are represented by load curves LCA, LCB, LCC, respectively. The latter two curves can be used to include the stiffening effects that are observed as the foam material crushes to the point where it begins to lock up. To ensure that the limit stress decreases with respect to the off-angle the curves should be defined such that following equations hold:

$$\frac{\partial \sigma^b(\varphi)}{\partial \varphi} \leq 0$$

and

$$\sigma^s(\epsilon^{vol}) - \sigma^w(\epsilon^{vol}) \geq 0.$$

A drawback of this implementation was that the material often collapsed in shear mode due to low shear resistance. There was no way of increasing the shear resistance without changing the behavior in pure uniaxial compression. We have therefore modified the model so that the user can optionally prescribe the shear and hydrostatic resistance in the material without affecting the uniaxial behavior. We introduce the parameters  $\sigma_p^Y(\epsilon^{vol})$  and  $\sigma_d^Y(\epsilon^{vol})$  as the *hydrostatic* and *shear limit stresses*, respectively. These are functions of the volumetric strain and are assumed given by

$$\begin{aligned} \sigma_p^Y(\epsilon^{vol}) &= \sigma_p^Y + \sigma^s(\epsilon^{vol}) \\ \sigma_d^Y(\epsilon^{vol}) &= \sigma_d^Y + \sigma^s(\epsilon^{vol}) \end{aligned}$$

where we have reused the densification function  $\sigma^s$ . The new parameters are the initial hydrostatic and shear limit stress values,  $\sigma_p^y$  and  $\sigma_d^y$ , and are provided by the user as GCAU and |ECCU|, respectively. The negative sign of ECCU flags the third yield surface option whenever  $LCA < 0$ . The effect of the third formulation is that (i) for a uniaxial stress the stress limit is given by  $\sigma^y(\varphi, \varepsilon^{vol})$ , (ii) for a pressure the stress limit is given by  $\sigma_p^y(\varepsilon^{vol})$  and (iii) for a simple shear the stress limit is given by  $\sigma_d^y(\varepsilon^{vol})$ . Experiments have shown that the model may give noisy responses and inhomogeneous deformation modes if parameters are not chosen with care. We therefore recommend to (i) avoid large slopes in the function  $\sigma^p$ , (ii) let the functions  $\sigma^s$  and  $\sigma^w$  be slightly increasing and (iii) avoid large differences between the stress limit values  $\sigma^y(\varphi, \varepsilon^{vol})$ ,  $\sigma_p^y(\varepsilon^{vol})$  and  $\sigma_d^y(\varepsilon^{vol})$ . These guidelines are likely to contradict how one would interpret test data and it is up to the user to find a reasonable trade-off between matching experimental results and avoiding the mentioned numerical side effects.

For fully compacted material (element formulations 1 and 2), we assume that the material behavior is elastic-perfectly plastic and updated the stress components according to:

$$s_{ij}^{trial} = s_{ij}^n + 2G\Delta\varepsilon_{ij}^{dev^{n+1/2}}$$

where the deviatoric strain increment is defined as

$$\Delta\varepsilon_{ij}^{dev} = \Delta\varepsilon_{ij} - \frac{1}{3}\Delta\varepsilon_{kk}\delta_{ij}$$

We now check to see if the yield stress for the fully compacted material is exceeded by comparing

$$s_{eff}^{trial} = \left(\frac{3}{2}s_{ij}^{trial}s_{ij}^{trial}\right)^{1/2}$$

the effective trial stress to the yield stress,  $\sigma_y$  (Card 3, field 21-30). If the effective trial stress exceeds the yield stress we simply scale back the stress components to the yield surface

$$s_{ij}^{n+1} = \frac{\sigma_y}{s_{eff}^{trial}} s_{ij}^{trial}$$

We can now update the pressure using the elastic bulk modulus, K

$$p^{n+1} = p^n - K\Delta\varepsilon_{kk}^{n+1/2}$$

$$K = \frac{E}{3(1-2\nu)}$$

and obtain the final value for the Cauchy stress

$$\sigma_{ij}^{n+1} = s_{ij}^{n+1} - p^{n+1}\delta_{ij}$$

After completing the stress update we transform the stresses back to the global configuration.

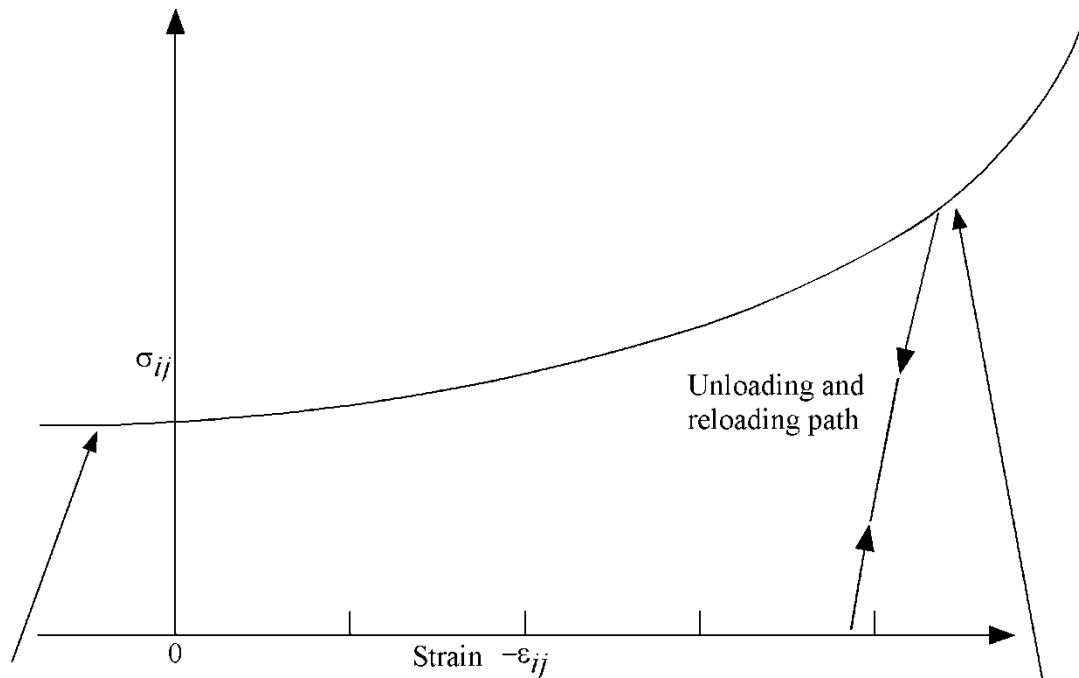

Curve extends into negative strain quadrant since LS-DYNA will extrapolate using the two end points. It is important that the extrapolation does not extend into the negative stress region.

Unloading is based on the interpolated Young's moduli which must provide an unloading tangent that exceeds the loading tangent.

**Figure 126.1.** Stress quantity versus strain. Note that the “yield stress” at a strain of zero is nonzero. In the load curve definition the “time” value is the directional strain and the “function” value is the yield stress. Note that for element types 0 and 9 engineering strains are used, but for all other element types the rates are integrated in time.

\*MAT\_ARRUDA\_BOYCE\_RUBBER

This is Material Type 127. This material model provides a hyperelastic rubber model, see [Arruda and Boyce 1993] combined optionally with linear viscoelasticity as outlined by [Christensen 1980].

Card 1            1            2            3            4            5            6            7            8

Variable	MID	RO	K	G	N			
Type	A8	F	F	F	F			

Card 2            1            2            3            4            5            6            7            8

Variable	LCID	TRAMP	NT					
Type	F	F	F					

**Card Format for Viscoelastic Constants. Up to 6 cards may be input. A keyword card (with a "\*" in column 1) terminates this input if less than 6 cards are used.**

Cards opt.       1            2            3            4            5            6            7            8

Variable	GI	BETA1						
Type	F	F						

<u>VARIABLE</u>	<u>DESCRIPTION</u>
MID	Material identification. A unique number or label not exceeding 8 characters must be specified.
RO	Mass density
K	Bulk modulus
G	Shear modulus
N	Number of statistical links

VARIABLE	DESCRIPTION
LCID	Optional load curve ID of relaxation curve If constants $\beta_i$ are determined via a least squares fit. This relaxation curve is shown in Figure 76.1. This model ignores the constant stress.
TRAMP	Optional ramp time for loading.
NT	Number of Prony series terms in optional fit. If zero, the default is 6. Currently, the maximum number is 6. Values less than 6, possibly 3-5 are recommended, since each term used adds significantly to the cost. Caution should be exercised when taking the results from the fit. Always check the results of the fit in the output file. Preferably, all generated coefficients should be positive. Negative values may lead to unstable results. Once a satisfactory fit has been achieved it is recommended that the coefficients which are written into the output file be input in future runs.
GI	Optional shear relaxation modulus for the <i>i</i> th term
BETAI	Optional decay constant if <i>i</i> th term

**Remarks:**

Rubber is generally considered to be fully incompressible since the bulk modulus greatly exceeds the shear modulus in magnitude. To model the rubber as an unconstrained material a hydrostatic work term,  $W_H(J)$ , is included in the strain energy functional which is function of the relative volume,  $J$ , [Ogden 1984]:

$$W(J_1, J_2, J) = nk\theta \left[ \frac{1}{2}(J_1 - 3) + \frac{1}{20N}(J_1^2 - 9) + \frac{11}{1050N^2}(J_1^3 - 27) \right] + nk\theta \left[ \frac{19}{7000N^3}(J_1^4 - 81) + \frac{519}{673750N^4}(J_1^5 - 243) \right] + W_H(J)$$

where the hydrostatic work term is in terms of the bulk modulus,  $K$ , and the third invariant,  $J$ , as:

$$W_H(J) = \frac{K}{2}(J - 1)^2$$

Rate effects are taken into account through linear viscoelasticity by a convolution integral of the form:

$$\sigma_{ij} = \int_0^t g_{ijkl}(t - \tau) \frac{\partial \varepsilon_{kl}}{\partial \tau} d\tau$$

or in terms of the second Piola-Kirchhoff stress,  $S_{ij}$ , and Green's strain tensor,  $E_{ij}$ ,



$$S_{ij} = \int_0^t G_{ijkl}(t-\tau) \frac{\partial E_{kl}}{\partial \tau} d\tau$$

where  $g_{ijkl}(t-\tau)$  and  $G_{ijkl}(t-\tau)$  are the relaxation functions for the different stress measures. This stress is added to the stress tensor determined from the strain energy functional.

If we wish to include only simple rate effects, the relaxation function is represented by six terms from the Prony series:

$$g(t) = \alpha_0 + \sum_{m=1}^N \alpha_m e^{-\beta t}$$

given by,

$$g(t) = \sum_{i=1}^n G_i e^{-\beta_i t}$$

This model is effectively a Maxwell fluid which consists of dampers and springs in series. We characterize this in the input by shear moduli,  $G_i$ , and decay constants,  $\beta_i$ . The viscoelastic behavior is optional and an arbitrary number of terms may be used.

**\*MAT\_HEART\_TISSUE**

This is Material Type 128. This material model provides a heart tissue model described in the paper by Walker *et al* [2005] as interpreted by Kay Sun. It is backward compatible with an earlier heart tissue model described in the paper by Guccione, McCulloch, and Waldman [1991]. Both models are transversely isotropic.

Card 1            1            2            3            4            5            6            7            8

Variable	MID	RO	C	B1	B2	B3	P	B
Type	A8	F	F	F	F	F	F	F

Card 2: Omit this card for the earlier model.

Card 2            1            2            3            4            5            6            7            8

Variable	L0	CA0MAX	LR	M	BB	CA0	TMAX	TACT
Type	F	I						

Card 3            1            2            3            4            5            6            7            8

Variable	AOPT	MACF						
Type	F	I						

Card 4            1            2            3            4            5            6            7            8

Variable	XP	YP	ZP	A1	A2	A3		
Type	F	F	F	F	F	F		

Card 5            1            2            3            4            5            6            7            8

Variable	V1	V2	V3	D1	D2	D3	BETA	
Type	F	F	F	F	F	F	F	

<u>VARIABLE</u>	<u>DESCRIPTION</u>
MID	Material identification. A unique number or label not exceeding 8 characters must be specified.
RO	Mass density
C	Diastolic material coefficient.
B1	$b_1$ , diastolic material coefficient.
B2	$b_2$ , diastolic material coefficient.
B3	$b_3$ , diastolic material coefficient.
P	Pressure in the muscle tissue
B	Systolic material coefficient. Omit for the earlier model.
L0	$l_0$ , sarcomere length at which no active tension develops. Omit for the earlier model.
CA0MAX	$(Ca_0)_{max}$ , maximum peak intracellular calcium concentration. Omit for the earlier model.
LR	$l_R$ , Stress-free sarcomere length. Omit for the earlier model.
M	Systolic material coefficient. Omit for the earlier model.
BB	Systolic material coefficient. Omit for the earlier model.
CA0	$Ca_0$ , peak intracellular calcium concentration. Omit for the earlier model.
TMAX	$T_{max}$ , maximum isometric tension achieved at the longest sarcomere length. Omit for the earlier model.
TACT	$t_{act}$ , time at which active contraction initiates. Omit for the earlier model.

VARIABLE	DESCRIPTION
AOPT	<p>Material axes option (see MAT_OPTION TROPIC_ELASTIC for a more complete description):</p> <p>EQ.0.0: locally orthotropic with material axes determined by element nodes 1, 2, and 4, as with *DEFINE_COORDINATE_NODES.</p> <p>EQ.1.0: locally orthotropic with material axes determined by a point in space and the global location of the element center; this is the a-direction.</p> <p>EQ.2.0: globally orthotropic with material axes determined by vectors defined below, as with *DEFINE_COORDINATE_VECTOR.</p> <p>EQ.3.0: locally orthotropic material axes determined by rotating the material axes about the element normal by an angle, BETA, from a line in the plane of the element defined by the cross product of the vector <b>v</b> with the element normal.</p> <p>EQ.4.0: locally orthotropic in cylindrical coordinate system with the material axes determined by a vector <b>v</b>, and an originating point, <b>P</b>, which define the centerline axis.</p> <p>LT.0.0: the absolute value of AOPT is a coordinate system ID number (CID on *DEFINE_COORDINATE_NODES, *DEFINE_COORDINATE_SYSTEM or *DEFINE_COORDINATE_VECTOR). Available in R3 version of 971 and later.</p>
MACF	<p>Material axes change flag for brick elements:</p> <p>EQ.1: No change, default,</p> <p>EQ.2: switch material axes a and b,</p> <p>EQ.3: switch material axes a and c,</p> <p>EQ.4: switch material axes b and c.</p>
XP,YP,ZP	<p><math>x_p y_p z_p</math>, define coordinates of point <b>p</b> for AOPT = 1 and 4.</p>
A1,A2,A3	<p><math>a_1 a_2 a_3</math>, define components of vector <b>a</b> for AOPT = 2.</p>
D1,D2,D3	<p><math>d_1 d_2 d_3</math>, define components of vector <b>d</b> for AOPT = 2.</p>
V1,V2,V3	<p><math>v_1 v_2 v_3</math>, define components of vector <b>v</b> for AOPT = 3 and 4.</p>
BETA	<p>Material angle in degrees for AOPT = 3, may be overridden on the element card, see *ELEMENT_SOLID_ORTHO.</p>

**Remarks:**

1) The tissue model is described in terms of the energy functional that is transversely isotropic with respect to the local fiber direction,

$$W = \frac{c}{2}(e^Q - 1)$$

$$Q = b_f E_{11}^2 + b_t (E_{22}^2 + E_{33}^2 + E_{23}^2 + E_{32}^2) + b_{fs} (E_{12}^2 + E_{21}^2 + E_{13}^2 + E_{31}^2)$$

with  $C$ ,  $b_f$ ,  $b_t$ , and  $b_{fs}$  material parameters and  $E$  the Lagrange-Green strains.

The systolic contraction was modeled as the sum of the passive stress derived from the strain energy function and an active fiber directional component,  $T_0$ , which is a function of time,  $t$ ,

$$\begin{aligned} \underline{\underline{S}} &= \frac{\partial W}{\partial \underline{\underline{E}}} - pJ\underline{\underline{C}}^{-1} + T_0\{t, Ca_0, l\} \\ \underline{\underline{\sigma}} &= \frac{1}{J} \underline{\underline{F}} \underline{\underline{S}} \underline{\underline{F}}^T \end{aligned}$$

with  $\underline{\underline{S}}$  the second Piola-Kirchoff stress tensor,  $\underline{\underline{C}}$  the right Cauchy-Green deformation tensor,  $J$  the Jacobian of the deformation gradient tensor  $\underline{\underline{F}}$ , and  $\underline{\underline{\sigma}}$  the Cauchy stress tensor.

The active fiber directional stress component is defined by a time-varying elastance model, which at end-systole, is reduced to

$$T_0 = T_{max} \frac{Ca_0^2}{Ca_0^2 + ECa_{50}^2} C_t$$

with  $T_{max}$  the maximum isometric tension achieved at the longest sacromere length and maximum peak intracellular calcium concentration. The length-dependent calcium sensitivity and internal variable is given by,

$$\begin{aligned} ECa_{50} &= \frac{(Ca_0)_{max}}{\sqrt{\exp[B(l-l_0)] - 1}} \\ C_t &= 1/2(1 - \cos w) \\ l &= l_R \sqrt{2E_{11} + 1} \\ w &= \pi \frac{0.25 + t_r}{t_r} \\ t_r &= ml + bb \end{aligned}$$

A cross-fiber, in-plane stress equivalent to 40% of that along the myocardial fiber direction is added.

2) The earlier tissue model is described in terms of the energy functional in terms of the Green strain components,  $E_{ij}$ ,

$$W(E) = \frac{c}{2}(e^{\rho} - 1) + \frac{1}{2}P(I_3 - 1)$$

$$Q = b_1 E_{11}^2 + b_2 (E_{22}^2 + E_{33}^2 + E_{23}^2 + E_{32}^2) + b_3 (E_{12}^2 + E_{21}^2 + E_{13}^2 + E_{31}^2)$$

The Green components are modified to eliminate any effects of volumetric work following the procedures of Ogden. See the paper by Guccione *et al* [1991] for more detail.

\*MAT\_LUNG\_TISSUE

This is Material Type 129. This material model provides a hyperelastic model for heart tissue, see [Vawter 1980] combined optionally with linear viscoelasticity as outlined by [Christensen 1980].

Card 1            1            2            3            4            5            6            7            8

Variable	MID	RO	K	C	DELTA	ALPHA	BETA	
Type	A8	F	F	F	I			

Card 2            1            2            3            4            5            6            7            8

Variable	C1	C2	LCID	TRAMP	NT			
Type	F	F	F	F	F			

**Card Format for Viscoelastic Constants. Up to 6 cards may be input. A keyword card (with a "\*" in column 1) terminates this input if less than 6 cards are used.**

Cards opt.       1            2            3            4            5            6            7            8

Variable	GI	BETA1						
Type	F	F						

<u>VARIABLE</u>	<u>DESCRIPTION</u>
MID	Material identification. A unique number or label not exceeding 8 characters must be specified.
RO	Mass density
K	Bulk modulus
C	Material coefficient.
DELTA	$\Delta$ , material coefficient.

VARIABLE	DESCRIPTION
ALPHA	$\alpha$ , material coefficient.
BETA	$\beta$ , material coefficient.
C1	Material coefficient.
C2	Material coefficient.
LCID	Optional load curve ID of relaxation curve If constants $\beta t$ are determined via a least squares fit. This relaxation curve is shown in Figure 76.1. This model ignores the constant stress.
TRAMP	Optional ramp time for loading.
NT	Number of Prony series terms in optional fit. If zero, the default is 6. Currently, the maximum number is 6. Values less than 6, possibly 3-5 are recommended, since each term used adds significantly to the cost. Caution should be exercised when taking the results from the fit. Always check the results of the fit in the output file. Preferably, all generated coefficients should be positive. Negative values may lead to unstable results. Once a satisfactory fit has been achieved it is recommended that the coefficients which are written into the output file be input in future runs.
GI	Optional shear relaxation modulus for the ith term
BETAI	Optional decay constant if ith term

**Remarks:**

The material is described by a strain energy functional expressed in terms of the invariants of the Green Strain:

$$W(I_1, I_2) = \frac{C}{2\Delta} e^{(\alpha I_1^2 + \beta I_2)} + \frac{12C_1}{\Delta(1+C_2)} [A^{(1+C_2)} - 1]$$

$$A^2 = \frac{4}{3}(I_1 + I_2) - 1$$

where the hydrostatic work term is in terms of the bulk modulus,  $K$ , and the third invariant,  $J$ , as:

$$W_H(J) = \frac{K}{2}(J - 1)^2$$

Rate effects are taken into account through linear viscoelasticity by a convolution integral of the form:



$$\sigma_{ij} = \int_0^t g_{ijkl}(t-\tau) \frac{\partial \varepsilon_{kl}}{\partial \tau} d\tau$$

or in terms of the second Piola-Kirchhoff stress,  $S_{ij}$ , and Green's strain tensor,  $E_{ij}$ ,

$$S_{ij} = \int_0^t G_{ijkl}(t-\tau) \frac{\partial E_{kl}}{\partial \tau} d\tau$$

where  $g_{ijkl}(t-\tau)$  and  $G_{ijkl}(t-\tau)$  are the relaxation functions for the different stress measures. This stress is added to the stress tensor determined from the strain energy functional.

If we wish to include only simple rate effects, the relaxation function is represented by six terms from the Prony series:

$$g(t) = \alpha_0 + \sum_{m=1}^N \alpha_m e^{-\beta t}$$

given by,

$$g(t) = \sum_{i=1}^n G_i e^{-\beta_i t}$$

This model is effectively a Maxwell fluid which consists of a dampers and springs in series. We characterize this in the input by shear moduli,  $G_i$ , and decay constants,  $\beta_i$ . The viscoelastic behavior is optional and an arbitrary number of terms may be used.

**\*MAT\_SPECIAL\_ORTHOTROPIC**

This is Material Type 130. This model is available the Belytschko-Tsay and the C0 triangular shell elements and is based on a resultant stress formulation. In-plane behavior is treated separately from bending in order to model perforated materials such as television shadow masks. If other shell formulations are specified, the formulation will be automatically switched to Belytschko-Tsay. As implemented, this material model cannot be used with user defined integration rules.

Card 1            1            2            3            4            5            6            7            8

Variable	MID	RO	YS	EP				
Type	A8	F	F	F				

Card 2            1            2            3            4            5            6            7            8

Variable	E11P	E22P	V12P	V21P	G12P	G23P	G31P	
Type	F	F	F	F	F	F	F	

Card 3            1            2            3            4            5            6            7            8

Variable	E11B	E22B	V12B	V21B	G12B	AOPT		
Type	F	F	F	F	F	F		

Card 4            1            2            3            4            5            6            7            8

Variable				A1	A2	A3		
Type				F	F	F		

Card 5            1            2            3            4            5            6            7            8

Variable	V1	V2	V3	D1	D2	D3	BETA	
Type	F	F	F	F	F	F	F	

<u>VARIABLE</u>	<u>DESCRIPTION</u>
MID	Material identification. A unique number or label not exceeding 8 characters must be specified.
RO	Mass density.
YS	Yield stress. This parameter is optional and is approximates the yield condition. Set to zero if the behavior is elastic.
EP	Plastic hardening modulus.
E11P	$E_{11p}$ , for in plane behavior.
E22P	$E_{22p}$ , for in plane behavior.
V12P	$\nu_{12p}$ , for in plane behavior.
V11P	$\nu_{21p}$ , for in plane behavior.
G12P	$G_{12p}$ , for in plane behavior.
G23P	$G_{23p}$ , for in plane behavior.
G31P	$G_{31p}$ , for in plane behavior.
E11B	$E_{11b}$ , for bending behavior.
E22B	$E_{22b}$ , for bending behavior.
V12B	$\nu_{12b}$ , for bending behavior.
V21B	$\nu_{21b}$ , for bending behavior.
G12B	$G_{12b}$ , for bending behavior.

VARIABLE	DESCRIPTION
AOPT	<p>Material axes option (see MAT_OPTION TROPIC_ELASTIC for a more complete description):</p> <p>EQ.0.0: locally orthotropic with material axes determined by element nodes 1, 2, and 4, as with *DEFINE_COORDINATE_NODES, and then rotated about the shell element normal by an angle BETA.</p> <p>EQ.2.0: globally orthotropic with material axes determined by vectors defined below, as with *DEFINE_COORDINATE_VECTOR.</p> <p>EQ.3.0: locally orthotropic material axes determined by rotating the material axes about the element normal by an angle, BETA, from a line in the plane of the element defined by the cross product of the vector <b>v</b> with the element normal.</p> <p>LT.0.0: the absolute value of AOPT is a coordinate system ID number (CID on *DEFINE_COORDINATE_NODES, *DEFINE_COORDINATE_SYSTEM or *DEFINE_COORDINATE_VECTOR). Available in R3 version of 971 and later.</p>
A1,A2,A3	a <sub>1</sub> a <sub>2</sub> a <sub>3</sub> , define components of vector <b>a</b> for AOPT = 2.
D1,D2,D3	d <sub>1</sub> d <sub>2</sub> d <sub>3</sub> , define components of vector <b>d</b> for AOPT = 2.
V1,V2,V3	v <sub>1</sub> v <sub>2</sub> v <sub>3</sub> , define components of vector <b>v</b> for AOPT = 3.
BETA	Material angle in degrees for AOPT = 0 and 3, may be overridden on the element card, see *ELEMENT_SHELL_BETA.

**Remarks:**

The in-plane elastic matrix for in-plane, plane stress behavior is given by:

$$C_{in\ plane} = \begin{bmatrix} Q_{11p} & Q_{12p} & 0 & 0 & 0 \\ Q_{12p} & Q_{22p} & 0 & 0 & 0 \\ 0 & 0 & Q_{44p} & 0 & 0 \\ 0 & 0 & 0 & Q_{55p} & 0 \\ 0 & 0 & 0 & 0 & Q_{66p} \end{bmatrix}$$

The terms  $Q_{ip}$  are defined as:

$$Q_{11p} = \frac{E_{11p}}{1 - \nu_{12p}\nu_{21p}}$$

$$Q_{22p} = \frac{E_{22p}}{1 - \nu_{12p}\nu_{21p}}$$

$$Q_{12p} = \frac{\nu_{12p} E_{11p}}{1 - \nu_{12p} \nu_{21p}}$$

$$Q_{44p} = G_{12p}$$

$$Q_{55p} = G_{23p}$$

$$Q_{66p} = G_{31p}$$

The elastic matrix for bending behavior is given by:

$$C_{bending} = \begin{bmatrix} Q_{11b} & Q_{12b} & 0 \\ Q_{12b} & Q_{22b} & 0 \\ 0 & 0 & Q_{44b} \end{bmatrix}$$

The terms  $Q_{ip}$  are similarly defined.

**\*MAT\_ISOTROPIC\_SMEARED\_CRACK**

This is Material Type 131. This model was developed by Lemmen and Meijer [2001] as a smeared crack model for isotropic materials. This model is available of solid elements only and is restricted to cracks in the x-y plane. Users should choose other models unless they have the report by Lemmen and Meijer [2001].

Card 1            1            2            3            4            5            6            7            8

Variable	MID	RO	E	PR	ISPL	SIGF	GK	SR
Type	A8	F	F	F	I	F	F	F

<u>VARIABLE</u>	<u>DESCRIPTION</u>
MID	Material identification. A unique number or label not exceeding 8 characters must be specified.
RO	Mass density
E	Young's modulus
PR	Poisson's ratio
ISPL	Failure option: EQ.0: Maximum principal stress criterion EQ.5: Smeared crack model EQ.6: Damage model based on modified von Mises strain
SIGF	Peak stress.
GK	Critical energy release rate.
SR	Strength ratio.

**Remarks:**

The following documentation is taken nearly verbatim from the documentation of Lemmen and Meijer [2001].

Three methods are offered to model progressive failure. The maximum principal stress criterion detects failure if the maximum (most tensile) principal stress exceeds  $\sigma_{max}$ . Upon failure, the material can no longer carry stress.

The second failure model is the smeared crack model with linear softening stress-strain using equivalent uniaxial strains. Failure is assumed to be perpendicular to the principal strain directions. A rotational crack concept is employed in which the crack directions are related to the current directions of principal strain. Therefore crack directions may rotate in time. Principal stresses are expressed as

$$\begin{pmatrix} \sigma_1 \\ \sigma_2 \\ \sigma_3 \end{pmatrix} = \begin{bmatrix} \bar{E}_1 & 0 & 0 \\ 0 & \bar{E}_2 & 0 \\ 0 & 0 & \bar{E}_3 \end{bmatrix} \begin{pmatrix} \tilde{\epsilon}_1 \\ \tilde{\epsilon}_2 \\ \tilde{\epsilon}_3 \end{pmatrix} = \begin{pmatrix} \bar{E}_1 \tilde{\epsilon}_1 \\ \bar{E}_2 \tilde{\epsilon}_2 \\ \bar{E}_3 \tilde{\epsilon}_3 \end{pmatrix} \quad (131.1)$$

with  $\bar{E}_1$ ,  $\bar{E}_2$  and  $\bar{E}_3$  secant stiffness in the terms that depend on internal variables.

In the model developed for DYCOSS it has been assumed that there is no interaction between the three directions in which case stresses simply follow from

$$\sigma_j(\tilde{\epsilon}_j) = \begin{cases} E\tilde{\epsilon}_j & \text{if } 0 \leq \tilde{\epsilon}_j \leq \tilde{\epsilon}_{j,ini} \\ \bar{\sigma} \left( 1 - \frac{\tilde{\epsilon}_j - \tilde{\epsilon}_{j,ini}}{\tilde{\epsilon}_{j,ult} - \tilde{\epsilon}_{j,ini}} \right) & \text{if } \tilde{\epsilon}_{j,ini} < \tilde{\epsilon}_j \leq \tilde{\epsilon}_{j,ult} \\ 0 & \text{if } \tilde{\epsilon}_j > \tilde{\epsilon}_{j,ult} \end{cases} \quad (131.2)$$

with  $\bar{\sigma}$  the ultimate stress,  $\tilde{\epsilon}_{j,ini}$  the damage threshold, and  $\tilde{\epsilon}_{j,ult}$  the ultimate strain in  $j$ -direction. The damage threshold is defined as

$$\tilde{\epsilon}_{j,ini} = \frac{\bar{\sigma}}{E} \quad (131.3)$$

The ultimate strain is obtained by relating the crack growth energy and the dissipated energy

$$\iint \bar{\sigma} d\tilde{\epsilon}_{j,ult} dV = GA \quad (131.4)$$

with  $G$  the energy release rate,  $V$  the element volume and  $A$  the area perpendicular to the principal strain direction. The one point elements LS-DYNA have a single integration point and the integral over the volume may be replaced by the volume. For linear softening it follows

$$\tilde{\epsilon}_{j,ult} = \frac{2GA}{V\bar{\sigma}} \quad (131.5)$$

The above formulation may be regarded as a damage equivalent to the maximum principle stress criterion.

The third model is a damage model represented by Brekelmans et. al [1991]. Here the Cauchy stress tensor  $\sigma$  is expressed as

$$\sigma = (1 - D)E\varepsilon \tag{131.6}$$

where  $D$  represents the current damage and the factor  $(1-D)$  is the reduction factor caused by damage. The scalar damage variable is expressed as function of a so-called damage equivalent strain  $\varepsilon_d$

$$D = D(\varepsilon_d) = 1 - \frac{\varepsilon_{mi}(\varepsilon_{ult} - \varepsilon_d)}{\varepsilon_d(\varepsilon_{ult} - \varepsilon_{mi})} \tag{131.7}$$

and

$$\varepsilon_d = \frac{k-1}{2k(1-2\nu)} J_1 + \frac{1}{2k} \sqrt{\left(\frac{k-1}{1-2\nu} J_1\right)^2 + \frac{6k}{(1+\nu)^2} J_2} \tag{131.8}$$

where the constant  $k$  represents the ratio of the strength in tension over the strength in compression

$$k = \frac{\sigma_{ult, tension}}{\sigma_{ult, compression}} \tag{131.9}$$

$J_1$  resp.  $J_2$  are the first and second invariant of the strain tensor representing the volumetric and the deviatoric straining respectively

$$\begin{aligned} J_1 &= tr(\varepsilon) \\ J_2 &= tr(\varepsilon \cdot \varepsilon) - \frac{1}{3} tr^2(\varepsilon) \end{aligned} \tag{131.10}$$

If the compression and tension strength are equal the dependency on the volumetric strain vanishes in (8) and failure is shear dominated. If the compressive strength is much larger than the strength in tension,  $k$  becomes small and the  $J_1$  terms in (131.8) dominate the behavior.



**\*MAT\_ORTHOTROPIC\_SMEARED\_CRACK**

This is Material Type 132. This material is a smeared crack model for orthotropic materials.

Card 1            1            2            3            4            5            6            7            8

Variable	MID	RO	EA	EB	EC	PRBA	PRCA	PRCB
Type	A8	F	F	F	F	F	F	F

Card 2            1            2            3            4            5            6            7            8

Variable	UINS	UISS	CERRMI	CERRMII	IND	ISD		
Type	F	F	F	F	I	I		

Card 3            1            2            3            4            5            6            7            8

Variable	GAB	GBC	GCA	AOPT				
Type	F	F	F	F				

Card 4            1            2            3            4            5            6            7            8

Variable	XP	YP	ZP	A1	A2	A3	MACF	
Type	F	F	F	F	F	F	I	

Card 5            1            2            3            4            5            6            7            8

Variable	V1	V2	V3	D1	D2	D3	BETA	REF
Type	F	F	F	F	F	F	F	F

<u>VARIABLE</u>	<u>DESCRIPTION</u>
MID	Material identification. A unique number or label not exceeding 8 characters must be specified.
RO	Mass density.
EA	$E_a$ , Young's modulus in $a$ -direction.
EB	$E_b$ , Young's modulus in $b$ -direction.
EC	$E_c$ , Young's modulus in $c$ -direction
PRBA	$\nu_{ba}$ , Poisson's ratio $ba$ .
PRCA	$\nu_{ca}$ , Poisson's ratio $ca$ .
PRCB	$\nu_{cb}$ , Poisson's ratio $cb$ .
UINS	Ultimate interlaminar normal stress.
UISS	Ultimate interlaminar shear stress.
CERRMI	Critical energy release rate mode I
CERRMII	Critical energy release rate mode II
IND	Interlaminar normal direction : EQ.1.0: Along local $a$ axis EQ.2.0: Along local $b$ axis EQ.3.0: Along local $c$ axis
ISD	Interlaminar shear direction : EQ.4.0: Along local $ab$ axis EQ.5.0: Along local $bc$ axis EQ.6.0: Along local $ca$ axis
GAB	$G_{ab}$ , shear modulus $ab$ .

VARIABLE	DESCRIPTION
GBC	$G_{bc}$ , shear modulus bc.
GCA	$G_{ca}$ , shear modulus ca.
AOPT	<p>Material axes option, see Figure 2.1.</p> <p>EQ.0.0: locally orthotropic with material axes determined by element nodes as shown in Figure 2.1. Nodes 1, 2, and 4 of an element are identical to the nodes used for the definition of a coordinate system as by *DEFINE_COORDINATE_NODES.</p> <p>EQ.1.0: locally orthotropic with material axes determined by a point in space and the global location of the element center; this is the a-direction. This option is for solid elements only.</p> <p>EQ.2.0: globally orthotropic with material axes determined by vectors defined below, as with *DEFINE_COORDINATE_VECTOR.</p> <p>EQ.3.0: locally orthotropic material axes determined by rotating the material axes about the element normal by an angle, BETA, from a line in the plane of the element defined by the cross product of the vector <math>\mathbf{v}</math> with the element normal. The plane of a solid element is the midsurface between the inner surface and outer surface defined by the first four nodes and the last four nodes of the connectivity of the element, respectively.</p> <p>EQ.4.0: locally orthotropic in cylindrical coordinate system with the material axes determined by a vector <math>\mathbf{v}</math>, and an originating point, P, which define the centerline axis. This option is for solid elements only.</p> <p>LT.0.0: the absolute value of AOPT is a coordinate system ID number (CID on *DEFINE_COORDINATE_NODES, *DEFINE_COORDINATE_SYSTEM or *DEFINE_COORDINATE_VECTOR). Available in R3 version of 971 and later.</p>
XP YP ZP	Define coordinates of point $\mathbf{p}$ for AOPT = 1 and 4.
A1 A2 A3	Define components of vector $\mathbf{a}$ for AOPT = 2.
MACF	<p>Material axes change flag for brick elements:</p> <p>EQ.1: No change, default,</p> <p>EQ.2: switch material axes a and b,</p> <p>EQ.3: switch material axes a and c,</p> <p>EQ.4: switch material axes b and c.</p>
V1 V2 V3	Define components of vector $\mathbf{v}$ for AOPT = 3 and 4.
D1 D2 D3	Define components of vector $\mathbf{d}$ for AOPT = 2:

VARIABLE	DESCRIPTION
BETA	Material angle in degrees for AOPT = 3, may be overridden on the element card, see *ELEMENT_SOLID_ORTHO.
REF	Use reference geometry to initialize the stress tensor. The reference geometry is defined by the keyword: *INITIAL_FOAM_REFERENCE_GEOMETRY (see there for more details). EQ.0.0: off, EQ.1.0: on.

**Remarks:**

This is an orthotropic material with optional delamination failure for brittle composites. The elastic formulation is identical to the DYNA3D model that uses total strain formulation. The constitutive matrix **C** that relates to global components of stress to the global components of strain is defined as:

$$C = T^T C_L T$$

where T is the transformation matrix between the local material coordinate system and the global system and  $C_L$  is the constitutive matrix defined in terms of the material constants of the local orthogonal material axes *a*, *b*, and *c* (see DYNA3D use manual).

Failure is described using linear softening stress strain curves for interlaminar normal and interlaminar shear direction. The current implementation for failure is essentially 2-D. Damage can occur in interlaminar normal direction and a single interlaminar shear direction. The orientation of these directions w.r.t. the principal material directions have to be specified by the user.

Based on specified values for the ultimate stress and the critical energy release rate bounding surfaces are defined

$$f_n = \sigma_n - \bar{\sigma}_n(\epsilon_n)$$

$$f_s = \sigma_s - \bar{\sigma}_s(\epsilon_s)$$

where the subscripts n and s refer to the normal and shear component. If stresses exceed the bounding surfaces inelastic straining occurs. The ultimate strain is obtained by relating the crack growth energy and the dissipated energy. For solid elements with a single integration point it can be derived

$$\epsilon_{i, ult} = \frac{2GA}{V\sigma_{i, ult}}$$

with *G* the critical energy release rate, *V* the element volume, *A* the area perpendicular to the active normal direction and  $\sigma_{i, ult}$  the ultimate stress. For the normal component failure can only occur under tensile loading. For shear component the behavior is symmetric around zero. The

resulting stress bounds are depicted in Figure 132.1. Unloading is modeled with a Secant stiffness.

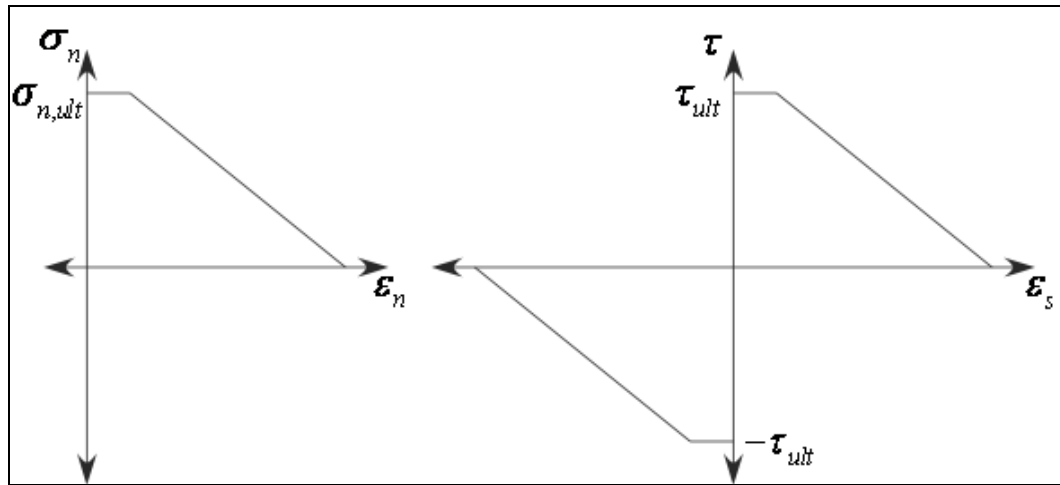

**Figure 132.1.** Shows stress bounds for the active normal component (left) and the archite shear component (right).

**\*MAT\_BARLAT\_YLD2000**

This is Material Type 133. This model was developed by Barlat et al. [2003] to overcome some shortcomings of the six parameter Barlat model implemented as material 33 (MAT\_BARLAT\_YLD96) in LS-DYNA. This model is available for shell elements only.

Card 1            1            2            3            4            5            6            7            8

Variable	MID	RO	E	PR	FIT	BETA	ITER	ISCALE
Type	A8	F	F	F	F	F	F	F

Card 2            1            2            3            4            5            6            7            8

Variable	K	E0	N	C	P	HARD	A	
Type	F	F	F	F	F	F	F	

**Define the following card if and only if A<0**

Card 3            1            2            3            4            5            6            7            8

Variable	CRC1	CRA1	CRC2	CRA2	CRC3	CRA3	CRC4	CRA4
Type	F	F	F	F	F	F	F	F

**Define the following card if and only if FIT=0**

Card 3            1            2            3            4            5            6            7            8

Variable	ALPHA1	ALPHA2	ALPHA3	ALPHA4	ALPHA5	ALPHA6	ALPHA7	ALPHA8
Type	F	F	F	F	F	F	F	F

Define the following two cards if and only if FIT=1

Card 3            1            2            3            4            5            6            7            8

Variable	SIG00	SIG45	SIG90	R00	R45	R90		
Type	F	F	F	F	F	F		

Card 4            1            2            3            4            5            6            7            8

Variable	SIGXX	SIGYY	SIGXY	DXX	DYY	DXY		
Type	F	F	F	F	F	F		

Define the following three cards if and only if HARD=3

Card 4/5          1            2            3            4            5            6            7            8

Variable	CP	T0	TREF	TA0				
Type	F	F	F	F				

Card 5/6          1            2            3            4            5            6            7            8

Variable	A	B	C	D	P	Q	E0MART	VM0
Type	F	F	F	F	F	F	F	F

Card 6/7          1            2            3            4            5            6            7            8

Variable	AHS	BHS	M	N	EPS0	HMART	K1	K2
Type	F	F	F	F	F	F	F	F

Card 4/5      1          2          3          4          5          6          7          8

Variable	AOPT	OFFANG	P4	HTFLAG	HTA	HTB	HTC	HTD
Type	F	F	F	F	F	F	F	F

Card 5/6      1          2          3          4          5          6          7          8

Variable				A1	A2	A3		
Type				F	F	F		

Card 6/7      1          2          3          4          5          6          7          8

Variable	V1	V2	V3	D1	D2	D3		
Type	F	F	F	F	F	F		

<u>VARIABLE</u>	<u>DESCRIPTION</u>
MID	Material identification. A unique number or label not exceeding 8 characters must be specified.
RO	Mass density
E	Young's modulus LE.0: -E is load curve ID for Young's modulus vs. plastic strain
PR	Poisson's ratio
FIT	Material parameter fit flag: EQ.0.0: Material parameters are used directly on card 3. EQ.1.0: Material parameters are determined from test data on cards 3 and 4
BETA	Hardening parameter. Any value ranging from 0 (isotropic hardening) to 1 (kinematic hardening) may be input.



VARIABLE	DESCRIPTION
ITER	<p>Plastic iteration flag:</p> <p>EQ.0.0: Plane stress algorithm for stress return</p> <p>EQ.1.0: Secant iteration algorithm for stress return</p> <p>ITER provides an option of using three secant iterations for determining the thickness strain increment as experiments have shown that this leads to a more accurate prediction of shell thickness changes for rapid processes. A significant increase in computation time is incurred with this option so it should be used only for applications associated with high rates of loading and/or for implicit analysis.</p>
ISCALE	<p>Yield locus scaling flag:</p> <p>EQ.0.0: Scaling on - reference direction=rolling direction (default)</p> <p>EQ.1.0: Scaling off - reference direction arbitrary</p>
K	<p>Material parameter:</p> <p>HARD.EQ.1.0: k, strength coefficient for exponential hardening</p> <p>HARD.EQ.2.0: a in Voce hardening law</p> <p>HARD.EQ.4.0: k, strength coefficient for Gosh hardening</p> <p>HARD.EQ.5.0: a in Hockett-Sherby hardening law</p>
E0	<p>Material parameter:</p> <p>HARD.EQ.1.0: <math>\epsilon_0</math>, strain at yield for exponential hardening</p> <p>HARD.EQ.2.0: b in Voce hardening law</p> <p>HARD.EQ.4.0: <math>\epsilon_0</math>, strain at yield for Gosh hardening</p> <p>HARD.EQ.5.0: b in Hockett-Sherby hardening law</p>
N	<p>Material parameter:</p> <p>HARD.EQ.1.0: n, exponent for exponential hardening</p> <p>HARD.EQ.2.0: c in Voce hardening law</p> <p>HARD.EQ.4.0: n, exponent for Gosh hardening</p> <p>HARD.EQ.5.0: c in Hockett-Sherby hardening law</p>
C	<p>Cowper-Symonds strain rate parameter, C, see formula below.</p>
P	<p>Cowper-Symonds strain rate parameter, p.</p> $\sigma_y(\epsilon_p, \dot{\epsilon}_p) = \sigma_y(\epsilon_p) \left( 1 + \left\{ \frac{\dot{\epsilon}_p}{C} \right\}^{1/p} \right)$

VARIABLE	DESCRIPTION
HARD	Hardening law: EQ.1.0: Exponential hardening: $\sigma_y = k(\epsilon_0 + \epsilon_p)^n$ EQ.2.0: Voce hardening: $\sigma_y = a - be^{-c\epsilon_p}$ EQ.3.0: Hansel hardening EQ.4.0: Gosh hardening: $\sigma_y = k(\epsilon_0 + \epsilon_p)^n - p$ EQ.5.0: Hockett-Sherby hardening: $\sigma_y = a - be^{-c\epsilon_p^q}$ LT.0.0: Absolute value defines load curve ID
A	Flow potential exponent
CRCN	Chaboche-Roussilier kinematic hardening parameter, see remarks.
CRCA	Chaboche-Roussilier kinematic hardening parameter, see remarks.
ALPHA1	$\alpha_1$ , see equations below
ALPHA2	$\alpha_2$ , see equations below
ALPHA3	$\alpha_3$ , see equations below
ALPHA4	$\alpha_4$ , see equations below
ALPHA5	$\alpha_5$ , see equations below
ALPHA6	$\alpha_6$ , see equations below
ALPHA7	$\alpha_7$ , see equations below
ALPHA8	$\alpha_8$ , see equations below
SIG00	Yield stress in 00 direction
SIG45	Yield stress in 45 direction
SIG90	Yield stress in 90 direction
R00	R-value in 00 direction
R45	R-value in 45 direction
R90	R-value in 90 direction
SIGXX	xx-component of stress on yield surface (See Remark 2).
SIGYY	yy-component of stress on yield surface (See Remark 2).

VARIABLE	DESCRIPTION
SIGXY	xy-component of stress on yield surface (See Remark 2).
DXX	xx-component of tangent to yield surface (See Remark 2).
DYY	yy-component of tangent to yield surface (See Remark 2).
DXY	xy-component of tangent to yield surface (See Remark 2).
CP	Adiabatic temperature calculation option: EQ.0.0: Adiabatic temperature calculation is disabled. GT.0.0: CP is the specific heat $C_p$ . Adiabatic temperature calculation is enabled.
T0	Initial temperature $T_0$ of the material if adiabatic temperature calculation is enabled.
TREF	Reference temperature for output of the yield stress as history variable.
TA0	Reference temperature $T_{A0}$ , the absolute zero for the used temperature scale, e.g. -273.15 if the Celsius scale is used and 0.0 if the Kelvin scale is used.
A	Martensite rate equation parameter $A$ , see equations below.
B	Martensite rate equation parameter $B$ , see equations below.
C	Martensite rate equation parameter $C$ , see equations below.
D	Martensite rate equation parameter $D$ , see equations below.
P	Martensite rate equation parameter $p$ , see equations below.
Q	Martensite rate equation parameter $Q$ , see equations below.
E0MART	Martensite rate equation parameter $E_{0(mart)}$ , see equations below.
VM0	The initial volume fraction of martensite $0.0 < V_{m0} < 1.0$ may be initialised using two different methods: GT.0.0: $V_{m0}$ is set to VM0. LT.0.0: Can be used only when there are initial plastic strains $\varepsilon^p$ present, e.g. when using *INITIAL_STRESS_SHELL. The absolute value of VM0 is then the load curve ID for a function $f$ that sets $V_{m0} = f(\varepsilon^p)$ . The function $f$ must be a monotonically nondecreasing function of $\varepsilon^p$ .
AHS	Hardening law parameter $A_{HS}$ , see equations below.

VARIABLE	DESCRIPTION
BHS	Hardening law parameter $B_{HS}$ , see equations below.
M	Hardening law parameter $m$ , see equations below.
N	Hardening law parameter $n$ , see equations below.
EPS0	Hardening law parameter $\epsilon_0$ , see equations below.
HMART	Hardening law parameter $\Delta H_{\gamma \rightarrow \alpha}$ , see equations below.
K1	Hardening law parameter $K_1$ , see equations below.
K2	Hardening law parameter $K_2$ , see equations below
AOPT	<p>Material axes option:</p> <p>EQ.0.0: locally orthotropic with material axes determined by element nodes as shown in Figure 20.1. Nodes 1, 2, and 4 of an element are identical to the nodes used for the definition of a coordinate system as by *DEFINE_COORDINATE_NODES</p> <p>EQ.2.0: globally orthotropic with material axes determined by vectors defined below, as with *DEFINE_COORDINATE_VECTOR</p> <p>EQ.3.0: locally orthotropic material axes determined by offsetting the material axes by an angle, OFFANG, from a line determined by taking the cross product of the vector <math>\mathbf{v}</math> with the normal to the plane of the element.</p> <p>LT.0.0: the absolute value of AOPT is a coordinate system ID number (CID on *DEFINE_COORDINATE_NODES, *DEFINE_COORDINATE_SYSTEM or *DEFINE_COORDINATE_VECTOR). Available in R3 version of 971 and later.</p>
OFFANG	Offset angle for AOPT=3
P4	<p>Material parameter:</p> <p>HARD.EQ.4.0: <math>p</math> in Gosh hardening law</p> <p>HARD.EQ.5.0: <math>q</math> in Hockett-Sherby hardening law</p>
HTFLAG	<p>Heat treatment flag (see remarks):</p> <p>HTFLAG.EQ.0: Preforming stage</p> <p>HTFLAG.EQ.1: Heat treatment stage</p> <p>HTFLAG.EQ.2: Postforming stage</p>
HTA	Load curve/Table ID for postforming parameter A
HTB	Load curve/Table ID for postforming parameter B
HTC	Load curve/Table ID for postforming parameter C

VARIABLE	DESCRIPTION
HTD	Load curve/Table ID for postforming parameter D
A1 A2 A3	Components of vector <b>a</b> for AOPT=2
V1 V2 V3	Components of vector <b>v</b> for AOPT=3
D1 D2 D3	Components of vector <b>d</b> for AOPT=2

### Remarks:

- Strain rate is accounted for using the Cowper and Symonds model which scales the yield stress with the factor

$$1 + \left( \frac{\dot{\varepsilon}}{C} \right)^{1/p}$$

where  $\dot{\varepsilon}$  is the strain rate. A fully viscoplastic formulation is optional which incorporates the Cowper and Symonds formulation within the yield surface. An additional cost is incurred but the improvement allows for dramatic results. To ignore strain rate effects set both SRC and SRP to zero.

- The yield condition for this material can be written

$$f(\boldsymbol{\sigma}, \boldsymbol{\alpha}, \varepsilon_p) = \sigma_{\text{eff}}(\sigma_{xx} - 2\alpha_{xx} - \alpha_{yy}, \sigma_{yy} - 2\alpha_{yy} - \alpha_{xx}, \sigma_{xy} - \alpha_{xy}) - \sigma_Y^t(\varepsilon_p, \dot{\varepsilon}_p, \beta) \leq 0$$

where

$$\sigma_{\text{eff}}(s_{xx}, s_{yy}, s_{xy}) = \left( \frac{1}{2}(\phi' + \phi'') \right)^{1/a}$$

$$\phi' = |X'_1 - X'_2|^a$$

$$\phi'' = |2X''_1 + X''_2|^a + |X''_1 + 2X''_2|^a$$

The  $X'_i$  and  $X''_i$  are eigenvalues of  $X'_{ij}$  and  $X''_{ij}$  and are given by

$$X'_1 = \frac{1}{2} \left( X'_{11} + X'_{22} + \sqrt{(X'_{11} - X'_{22})^2 + 4X'^2_{12}} \right)$$

$$X'_2 = \frac{1}{2} \left( X'_{11} + X'_{22} - \sqrt{(X'_{11} - X'_{22})^2 + 4X'^2_{12}} \right)$$

and

$$X''_1 = \frac{1}{2} \left( X''_{11} + X''_{22} + \sqrt{(X''_{11} - X''_{22})^2 + 4X''^2_{12}} \right)$$

$$X''_2 = \frac{1}{2} \left( X''_{11} + X''_{22} - \sqrt{(X''_{11} - X''_{22})^2 + 4X''^2_{12}} \right)$$

respectively. The  $X'_{ij}$  and  $X''_{ij}$  are given by

$$\begin{pmatrix} X'_{11} \\ X'_{22} \\ X'_{12} \end{pmatrix} = \begin{pmatrix} L'_{11} & L'_{12} & 0 \\ L'_{21} & L'_{22} & 0 \\ 0 & 0 & L'_{33} \end{pmatrix} \begin{pmatrix} s_{xx} \\ s_{yy} \\ s_{xy} \end{pmatrix} \quad \begin{pmatrix} X''_{11} \\ X''_{22} \\ X''_{12} \end{pmatrix} = \begin{pmatrix} L''_{11} & L''_{12} & 0 \\ L''_{21} & L''_{22} & 0 \\ 0 & 0 & L''_{33} \end{pmatrix} \begin{pmatrix} s_{xx} \\ s_{yy} \\ s_{xy} \end{pmatrix}$$

where

$$\begin{pmatrix} L'_{11} \\ L'_{12} \\ L'_{21} \\ L'_{22} \\ L'_{33} \end{pmatrix} = \frac{1}{3} \begin{pmatrix} 2 & 0 & 0 \\ -1 & 0 & 0 \\ 0 & -1 & 0 \\ 0 & 2 & 0 \\ 0 & 0 & 3 \end{pmatrix} \begin{pmatrix} \alpha_1 \\ \alpha_2 \\ \alpha_7 \end{pmatrix} \quad \begin{pmatrix} L''_{11} \\ L''_{12} \\ L''_{21} \\ L''_{22} \\ L''_{33} \end{pmatrix} = \frac{1}{9} \begin{pmatrix} -2 & 2 & 8 & -2 & 0 \\ 1 & -4 & -4 & 4 & 0 \\ 4 & -4 & -4 & 1 & 0 \\ -2 & 8 & 2 & -2 & 0 \\ 0 & 0 & 0 & 0 & 9 \end{pmatrix} \begin{pmatrix} \alpha_3 \\ \alpha_4 \\ \alpha_5 \\ \alpha_6 \\ \alpha_8 \end{pmatrix}$$

The parameters  $\alpha_1$  to  $\alpha_8$  are the parameters that determines the shape of the yield surface. The material parameters can be determined from three uniaxial tests and a more general test. From the uniaxial tests the yield stress and R-values are used and from the general test an arbitrary point on the yield surface is used given by the stress components in the material system as

$$\boldsymbol{\sigma} = \begin{pmatrix} \sigma_{xx} \\ \sigma_{yy} \\ \sigma_{xy} \end{pmatrix}$$

together with a tangent of the yield surface in that particular point. For the latter the tangential direction should be determined so that

$$d_{xx} \dot{\epsilon}_{xx}^p + d_{yy} \dot{\epsilon}_{yy}^p + 2d_{xy} \dot{\epsilon}_{xy}^p = 0$$

The biaxial data can be set to zero in the input deck for LS-DYNA to just fit the uniaxial data.

- a. A kinematic hardening model is implemented following the works of Chaboche and Roussilier. A back stress  $\boldsymbol{\alpha}$  is introduced such that the effective stress is computed as

$$\sigma_{\text{eff}} = \sigma_{\text{eff}}(\sigma_{11} - 2\alpha_{11} - \alpha_{22}, \sigma_{22} - 2\alpha_{22} - \alpha_{11}, \sigma_{12} - \alpha_{12})$$

The back stress is the sum of up to four terms according to

$$\alpha_{ij} = \sum_{k=1}^4 \alpha_{ij}^k$$

and the evolution of each back stress component is as follows

$$\delta\alpha_{ij}^k = C_k \left( a_k \frac{s_{ij}}{\sigma_{\text{eff}}} - \alpha_{ij}^k \right) \delta\varepsilon_p$$

where  $C_k$  and  $a_k$  are material parameters,  $s_{ij}$  is the deviatoric stress tensor,  $\sigma_{\text{eff}}$  is the effective stress and  $\varepsilon_p$  is the effective plastic strain.

3. The Hansel hardening law is the same as in material 113 but is repeated here for the sake of convenience.

The hardening is temperature dependent and therefore this material model must be run either in a coupled thermo-mechanical solution, using prescribed temperatures or using the adiabatic temperature calculation option. Setting the parameter CP to the specific heat  $C_p$  of the material activates the adiabatic temperature calculation that calculates the temperature rate from the equation

$$\dot{T} = \frac{\sigma \cdot D^p}{\rho C_p},$$

where  $\sigma \cdot D^p$  is the plastically dissipated heat. Using the Kelvin scale is recommended, even though other scales may be used without problems.

The hardening behaviour is described by the following equations. The Martensite rate equation is

$$\frac{\partial V_m}{\partial \bar{\varepsilon}^p} = \begin{cases} 0, & \text{if } \varepsilon < E_{0(\text{mart})} \\ \frac{B}{A} \exp\left(\frac{Q}{T - T_{A0}}\right) \left(\frac{1 - V_m}{V_m}\right)^{(B+1)/B} V_m^p \frac{1}{2} (1 - \tanh(C + D \cdot T)), & \text{if } \bar{\varepsilon}^p \geq E_{0(\text{mart})} \end{cases}$$

where

$\bar{\varepsilon}^p$  = effective plastic strain and

$T$  = temperature.

The martensite fraction is integrated from the above rate equation:

$$V_m = \int_0^{\varepsilon} \frac{\partial V_m}{\partial \bar{\varepsilon}^p} d\bar{\varepsilon}^p.$$

It always holds that  $0.0 < V_m < 1.0$ . The initial martensite content is  $V_{m0}$  and must be greater than zero and less than 1.0. Note that  $V_{m0}$  is not used during a restart or when initializing the  $V_m$  history variable using \*INITIAL\_STRESS\_SHELL.

The yield stress  $\sigma_y$  is

$$\sigma_y = \left\{ B_{HS} - (B_{HS} - A_{HS}) \exp\left(-m \left[\bar{\varepsilon}^p + \varepsilon_0\right]^n\right) \right\} (K_1 + K_2 T) + \Delta H_{\gamma \rightarrow \alpha} V_m.$$

The parameters p and B should fulfill the following condition

$$(1+B)/B < p,$$

if not fulfilled then the martensite rate will approach infinity as  $V_m$  approaches zero. Setting the parameter  $\epsilon_0$  larger than zero, typical range 0.001-0.02 is recommended. A part from the effective true strain a few additional history variables are output, see below.

History variables that are output for post-processing:

*Variable Description*

- 19 Yield stress of material at temperature TREF. Useful to evaluate the strength of the material after e.g., a simulated forming operation.
- 20 Volume fraction martensite,  $V_m$
- 21 CP EQ.0.0: Not used  
CP GT.0.0: Temperature from adiabatic temperature calculation.

4. Heat treatment for increasing the formability of prestrained aluminum sheets can be simulated through the use of HTFLAG, where the intention is to run a forming simulation in steps involving preforming, springback, heat treatment and postforming. In each step the history is transferred to the next via the use of dynain (see \*INTERFACE\_SPRINGBACK). The first two steps are performed with HTFLAG=0 according to standard procedures, resulting in a plastic strain field  $\epsilon_p^0$  corresponding to the prestrain. The heat treatment step is performed using HTFLAG=1 in a coupled thermomechanical simulation, where the blank is heated. The coupling between thermal and mechanical is only that the maximum temperature  $T^0$  is stored as a history variable in the material model, this corresponding to the heat treatment temperature. Here it is important to export all history variables to the dynein file for the postforming step. In the final postforming step, HTFLAG=2, the yield stress is then augmented by the Hockett-Sherby like term

$$\Delta\sigma = b - (b - a) \exp\left(-c \left[\epsilon_p - \epsilon_p^0\right]^d\right)$$

where  $a$ ,  $b$ ,  $c$  and  $d$  are given as tables as functions of the heat treatment temperature  $T^0$  and prestrain  $\epsilon_p^0$ . That is, in the table definitions each load curve corresponds to a given prestrain and the load curve value is with respect to the heat treatment temperature,

$$a = a(T^0, \epsilon_p^0) \quad b = b(T^0, \epsilon_p^0) \quad c = c(T^0, \epsilon_p^0) \quad d = d(T^0, \epsilon_p^0)$$

The effect of heat treatment is that the material strength decreases but hardening increases, thus typically

$$a \leq 0 \quad b \geq a \quad c > 0 \quad d > 0$$



\*MAT\_VISCOELASTIC\_FABRIC

This is Material Type 134. The viscoelastic fabric model is a variation on the general viscoelastic model of material 76. This model is valid for 3 and 4 node membrane elements only and is strongly recommended for modeling isotropic viscoelastic fabrics where wrinkling may be a problem. For thin fabrics, buckling can result in an inability to support compressive stresses; thus, a flag is included for this option. If bending stresses are important use a shell formulation with model 76.

Card 1            1            2            3            4            5            6            7            8

Variable	MID	RO	BULK	(omit)	(omit)	(omit)	CSE	
Type	I	F	F				F	

**Insert a blank card here if constants are defined on cards 3,4,... below.**

**If fitting is done from a relaxation curve, specify fitting parameters on card 2.**

Card 2            1            2            3            4            5            6            7            8

Variable	LCID	NT	BSTART	TRAMP	LCIDK	NTK	BSTARTK	TRAMPK
Type	F	I	F	F	F	I	F	F

**Card Format for viscoelastic constants. Up to 6 cards may be input. A keyword card (with a "\*" in column 1) terminates this input if less than 6 cards are used. These cards are not needed if relaxation data is defined. The number of terms for the shear behavior may differ from that for the bulk behavior: simply insert zero if a term is not included.**

Optional            1            2            3            4            5            6            7            8  
Cards 3, . . .

Variable	GI	BETAI	KI	BETAKI				
Type	F	F	F	F				

<u>VARIABLE</u>	<u>DESCRIPTION</u>
MID	Material identification. A unique number must be specified.

<b>VARIABLE</b>	<b>DESCRIPTION</b>
RO	Mass density.
BULK	Elastic constant bulk modulus. If the bulk behavior is viscoelastic, then this modulus is used in determining the contact interface stiffness only.
CSE	Compressive stress flag (default = 0.0). EQ.0.0: don't eliminate compressive stresses EQ.1.0: eliminate compressive stresses
LCID	Load curve ID if constants, $G_i$ , and $\beta_i$ are determined via a least squares fit. This relaxation curve is shown below.
NT	Number of terms in shear fit. If zero the default is 6. Currently, the maximum number is set to 6.
BSTART	In the fit, $\beta_1$ is set to zero, $\beta_2$ is set to BSTART, $\beta_3$ is 10 times $\beta_2$ , $\beta_4$ is 10 times $\beta_3$ , and so on. If zero, BSTART=0.01.
TRAMP	Optional ramp time for loading.
LCIDK	Load curve ID for bulk behavior if constants, $K_i$ , and $\beta_{\kappa_i}$ are determined via a least squares fit. This relaxation curve is shown below.
NTK	Number of terms desired in bulk fit. If zero the default is 6. Currently, the maximum number is set to 6.
BSTARTK	In the fit, $\beta_{\kappa_1}$ is set to zero, $\beta_{\kappa_2}$ is set to BSTARTK, $\beta_{\kappa_3}$ is 10 times $\beta_{\kappa_2}$ , $\beta_{\kappa_4}$ is 10 times $\beta_{\kappa_3}$ , and so on. If zero, BSTARTK=0.01.
TRAMPK	Optional ramp time for bulk loading.
GI	Optional shear relaxation modulus for the ith term
BETAI	Optional shear decay constant for the ith term
KI	Optional bulk relaxation modulus for the ith term
BETAKI	Optional bulk decay constant for the ith term

**Remarks:**

Rate effects are taken into account through linear viscoelasticity by a convolution integral of the form:

$$\sigma_j = \int_0^t g_{ijkl}(t-\tau) \frac{\partial \epsilon_{kl}}{\partial \tau} d\tau$$

where  $g_{ijkl}(t-\tau)$  is the relaxation function.

If we wish to include only simple rate effects for the deviatoric stresses, the relaxation function is represented by six terms from the Prony series:

$$g(t) = \sum_{m=1}^N G_m e^{-\beta_m t}$$

We characterize this in the input by shear moduli,  $G_i$ , and decay constants,  $\beta_i$ . An arbitrary number of terms, up to 6, may be used when applying the viscoelastic model.

For volumetric relaxation, the relaxation function is also represented by the Prony series in terms of bulk moduli:

$$k(t) = \sum_{m=1}^N K_m e^{-\beta_{k_m} t}$$

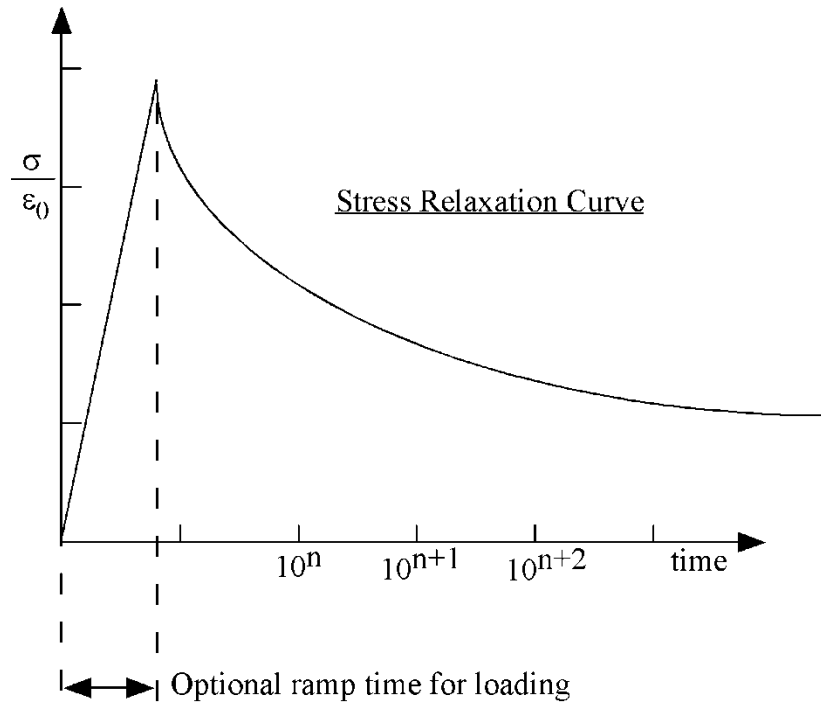

**Figure 134.1.** Relaxation curve. This curve defines stress versus time where time is defined on a logarithmic scale. For best results, the points defined in the load curve should be equally spaced on the logarithmic scale. Furthermore, the load curve should be smooth and defined in the positive quadrant. If nonphysical values are determined by least squares fit, LS-DYNA will terminate with an error message after the initialization phase is completed. If the ramp time for loading is included, then the relaxation which occurs during the loading phase is taken into account. This effect may or may not be important.

## \*MAT\_WTM\_STM

This is material type 135. This anisotropic-viscoplastic material model adopts two yield criteria for metals with orthotropic anisotropy proposed by Barlat and Lian [1989] (Weak Texture Model) and Aretz [2004] (Strong Texture Model).

Card 1            1            2            3            4            5            6            7            8

Variable	MID	RO	E	PR	NUMFI	EPSC	WC	TAUC
Type	A8	F	F	F	F	F	F	F

Card 2            1            2            3            4            5            6            7            8

Variable	SIGMA0	QR1	CR1	QR2	CR2	K	LC	FLG
Type	F	F	F	F	F	F	F	F

**Describe the following card for FLG = 0**

Card 3            1            2            3            4            5            6            7            8

Variable	A1	A2	A3	A4	A5	A6	A7	A8
Type	F	F	F	F	F	F	F	F

**Describe the following card for FLG = 1**

Card 3            1            2            3            4            5            6            7            8

Variable	S00	S45	S90	SBB	R00	R45	R90	RBB
Type	F	F	F	F	F	F	F	F

**Describe the following card for FLG = 2**

Card 3            1            2            3            4            5            6            7            8

Variable	A	C	H	P				
Type	F	F	F	F				

Card 4            1            2            3            4            5            6            7            8

Variable	QX1	CX1	QX2	CX2	EDOT	M	EMIN	S100
Type	F	F	F	F	F	F	F	F

Card 5            1            2            3            4            5            6            7            8

Variable	AOPT	BETA						
Type	F	F						

Card 6            1            2            3            4            5            6            7            8

Variable	XP	YP	ZP	A1	A2	A3		
Type	F	F	F	F	F	F		

Card 7            1            2            3            4            5            6            7            8

Variable	V1	V2	V3	D1	D2	D3		
Type	F	F	F	F	F	F		

VARIABLE	DESCRIPTION
MID	Material identification. A unique number or label not exceeding 8 characters must be specified.
RO	Mass density
E	Young's modulus
PR	Poisson's ratio
NUMFI	Number of through thickness integration points that must fail before the element is deleted (remember to change this number if switching between full and reduced integration type of elements).
EPSC	Critical value $\varepsilon_{IC}$ of the plastic thickness strain (used in the CTS fracture criterion).
WC	Critical value $W_c$ for the Cockcroft-Latham fracture criterion
TAUC	Critical value $\tau_c$ for the Bressan-Williams shear fracture criterion
SIGMA0	Initial mean value of yield stress $\sigma_0$
QR1	Isotropic hardening parameter $Q_{R1}$
CR1	Isotropic hardening parameter $C_{R1}$
QR2	Isotropic hardening parameter $Q_{R2}$
CR2	Isotropic hardening parameter $C_{R2}$
K	$k$ equals half YLD2003 exponent $m$ . Recommended value for FCC materials is $m = 8$ , i.e. $k = 4$ .
LC	First load curve number for process effects, i.e. the load curve describing the relation between the pre-strain and the yield stress $\sigma_0$ . Similar curves for $Q_{R1}$ , $C_{R1}$ , $Q_{R2}$ , $C_{R2}$ , and $W_c$ must follow consecutively from this number.
A1	Yld2003 parameter $a_1$
A2	Yld2003 parameter $a_2$
A3	Yld2003 parameter $a_3$

<b>VARIABLE</b>	<b>DESCRIPTION</b>
A4	Yld2003 parameter $a_4$
A5	Yld2003 parameter $a_5$
A6	Yld2003 parameter $a_6$
A7	Yld2003 parameter $a_7$
A8	Yld2003 parameter $a_8$
S00	Yield stress in $0^\circ$ direction
S45	Yield stress in $45^\circ$ direction
S90	Yield stress in $90^\circ$ direction
SBB	Balanced biaxial flow stress
R00	R-ratio in $0^\circ$ direction
R45	R-ratio in $45^\circ$ direction
R90	R-ratio in $90^\circ$ direction
RBB	Balance biaxial flow ratio
A	YLD89 parameter a
C	YLD89 parameter c
H	YLD89 parameter h
P	YLD89 parameter p
QX1	Kinematic hardening parameter $Q_{x1}$
CX1	Kinematic hardening parameter $C_{x1}$
QX2	Kinematic hardening parameter $Q_{x2}$
CX2	Kinematic hardening parameter $C_{x2}$
EDOT	Strain rate parameter $\dot{\epsilon}_0$



VARIABLE	DESCRIPTION
M	Strain rate parameter $m$
EMIN	<p>Lower limit of the isotropic hardening rate <math>\frac{dR}{d\bar{\epsilon}}</math>. This feature is included to model a non-zero and linear/exponential isotropic work hardening rate at large values of effective plastic strain. If the isotropic work hardening rate predicted by the utilized Voce-type work hardening rule falls below the specified value it is substituted by the prescribed value or switched to a power-law hardening if S100.NE.0. This option should be considered for problems involving extensive plastic deformations. If process dependent material characteristics are prescribed, i.e. if LC .GT. 0 the same minimum tangent modulus is assumed for all the prescribed work hardening curves. If instead EMIN.LT.0 then <math>-EMIN</math> defines the plastic strain value at which the linear or power-law hardening approximation commences.</p>
S100	Yield stress at 100% strain for using a power-law approximation beyond the strain defined by EMIN.
AOPT	<p>Material axes option (see MAT_OPTION TROPIC_ELASTIC for a more complete description):</p> <p>EQ.0.0: locally orthotropic with material axes determined by element nodes 1, 2, and 4, as with *DEFINE_COORDINATE_NODES, and then rotated about the shell element normal by an angle BETA.</p> <p>EQ.2.0: globally orthotropic with material axes determined by vectors defined below, as with *DEFINE_COORDINATE_VECTOR.</p> <p>EQ.3.0: locally orthotropic material axes determined by rotating the material axes about the element normal by an angle, BETA, from a line in the plane of the element defined by the cross product of the vector <math>\mathbf{v}</math> with the element normal.</p> <p>LT.0.0: the absolute value of AOPT is a coordinate system ID number (CID on *DEFINE_COORDINATE_NODES, *DEFINE_COORDINATE_SYSTEM or *DEFINE_COORDINATE_VECTOR). Available in R3 version of 971 and later..</p>
BETA	Material angle in degrees for AOPT = 0 or 3, may be overwritten on the element card, see *ELEMENT_SHELL_BETA.
XP YP ZP	Coordinates of point $\mathbf{p}$ for AOPT = 1.
A1 A2 A3	Components of vector $\mathbf{a}$ for AOPT = 2.
V1 V2 V3	Components of vector $\mathbf{v}$ for AOPT = 3

VARIABLE	DESCRIPTION
D1 D2 D3	Components of vector <b>d</b> for AOPT = 2.

**Remarks:**

If FLG=1, i.e. if the yield surface parameters  $a_1-a_8$  are identified on the basis of prescribed material data internally in the material routine, files with point data for plotting of the identified yield surface, along with the predicted directional variation of the yield stress and plastic flow are generated in the directory where the LS-DYNA analysis is run. Four different files are generated for each specified material.

These files are named according to the scheme:

1. Contour\_1#
2. Contour\_2#
3. Contour\_3#
4. R\_and\_S#

Where # is a value starting at 1.

The three first files contain contour data for plotting of the yield surface as shown in Figure 135.1. To generate these plots a suitable plotting program should be adopted and for each file/plot, column A should be plotted vs. columns B. For a more detailed description of these plots it is referred to References. Figure 135.2 further shows a plot generated from the final file named 'R\_and\_S#' showing the directional dependency of the normalized yield stress (column A vs. B) and plastic strain ratio (column B vs. C).

The yield condition for this material can be written

$$t(\boldsymbol{\sigma}, \boldsymbol{\alpha}, \boldsymbol{\varepsilon}^p, \dot{\boldsymbol{\varepsilon}}^p) = \sigma_{eff}(\boldsymbol{\sigma}, \boldsymbol{\alpha}) - \sigma_Y(\boldsymbol{\varepsilon}^p, \dot{\boldsymbol{\varepsilon}}^p)$$

where

$$\sigma_Y = \left( \sigma_0 + R(\boldsymbol{\varepsilon}^p) \right) \left( 1 + \frac{\dot{\boldsymbol{\varepsilon}}^p}{\dot{\boldsymbol{\varepsilon}}_0} \right)^C$$

where the isotropic hardening reads

$$R(\boldsymbol{\varepsilon}^p) = Q_{R1} \left( 1 - \exp(-C_{R1} \boldsymbol{\varepsilon}^p) \right) + Q_{R2} \left( 1 - \exp(-C_{R2} \boldsymbol{\varepsilon}^p) \right).$$

For the Weak Texture Model the yield function is defined as

$$\sigma_{eff} = \left[ \frac{1}{2} \left\{ a(k_1 + k_2)^m + a(k_1 - k_2)^m + C(2k_2)^m \right\} \right]^{\frac{1}{m}}$$

where

$$k_1 = \frac{\sigma_x + h \sigma_y}{2}$$

$$k_2 = \sqrt{\left(\frac{\sigma_x + h \sigma_y}{2}\right)^2 + (r \sigma_{xy})^2}.$$

For the Strong Texture Model the yield function is defined as

$$\sigma_{eff} = \left[ \frac{1}{2} \left\{ (\sigma'_1)^m + (\sigma'_2)^m + (\sigma''_1 - \sigma''_2)^m \right\} \right]^{\frac{1}{m}}$$

where

$$\begin{cases} \sigma'_1 \\ \sigma'_2 \end{cases} = \frac{a_8 \sigma_x + a_1 \sigma_y}{2} \pm \sqrt{\left(\frac{a_2 \sigma_x - a_3 \sigma_y}{2}\right)^2 + a_4^2 \sigma_{xy}^2}$$

$$\begin{cases} \sigma''_1 \\ \sigma''_2 \end{cases} = \frac{\sigma_x + \sigma_y}{2} \pm \sqrt{\left(\frac{a_5 \sigma_x - a_6 \sigma_y}{2}\right)^2 + a_7^2 \sigma_{xy}^2}.$$

Kinematic hardening can be included by

$$\boldsymbol{\alpha} = \sum_{R=1}^2 \boldsymbol{\alpha}_R$$

where each of the kinematic hardening variables  $\alpha_R$  is independent and obeys a nonlinear evolutionary equation in the form

$$\dot{\boldsymbol{\alpha}}_R = C_{ai} \left( Q_{ai} \frac{\boldsymbol{\tau}}{\sigma} - \boldsymbol{\alpha}_R \right) \dot{\boldsymbol{\epsilon}}^p$$

where the effective stress  $\bar{\sigma}$  is defined as  $\bar{\sigma} = \sigma_{eff}(\boldsymbol{\tau})$

where

$$\boldsymbol{\tau} = \boldsymbol{\sigma} - \boldsymbol{\alpha}.$$

Critical thickness strain failure in a layer is assumed to occur when

$$\varepsilon_t \leq \varepsilon_{tc}$$

where  $\varepsilon_{tc}$  is a material parameter. It should be noted that  $\varepsilon_{tc}$  is a negative number (i.e. failure is assumed to occur only in the case of thinning).

Cockcraft and Latham fracture is assumed to occur when

$$W = \int \max(\sigma_1, 0) d\varepsilon^p \geq W_c$$

where  $\sigma_1$  is the maximum principal stress and  $W_c$  is a material parameter.

<i>History Variable</i>	<i>Description</i>
1	Isotropic hardening value $R_1$
2	Isotropic hardening value $R_2$
3	Increment in effective plastic strain $\Delta\bar{\varepsilon}$
4	Not defined, for internal use in the material model
5	Not defined, for internal use in the material model
6	Not defined, for internal use in the material model
7	Failure in integration point EQ.0: No failure EQ.1: Failure due to EPSC, i.e. $\varepsilon_t \geq \varepsilon_{tc}$ . EQ.2: Failure due to WC, i.e. $W \geq W_c$ . EQ.3: Failure due to TAUC, i.e. $\tau \geq \tau_c$
8	Sum of incremental strain in local element x-direction: $\varepsilon_{xx} = \sum \Delta\varepsilon_{xx}$
9	Sum of incremental strain in local element y-direction: $\varepsilon_{yy} = \sum \Delta\varepsilon_{yy}$
10	Value of theh Cockcroft-Latham failure parameter $W = \sum \sigma_1 \Delta p$
11	Plastic strain component in thickness direction $\varepsilon_t$
12	Mean value of increments in plastic strain through the thickness (For use with the non-local instability criterion. Note that constant lamella thickness is assumed and the instability criterion can give unrealistic results if used with a user-defined integration rule with varying lamella thickness.)
13	Not defined, for internal use in the material model
14	Nonlocal value $\rho = \frac{\Delta\varepsilon_3}{\Delta\varepsilon_3^\Omega}$

**Table 135.1**

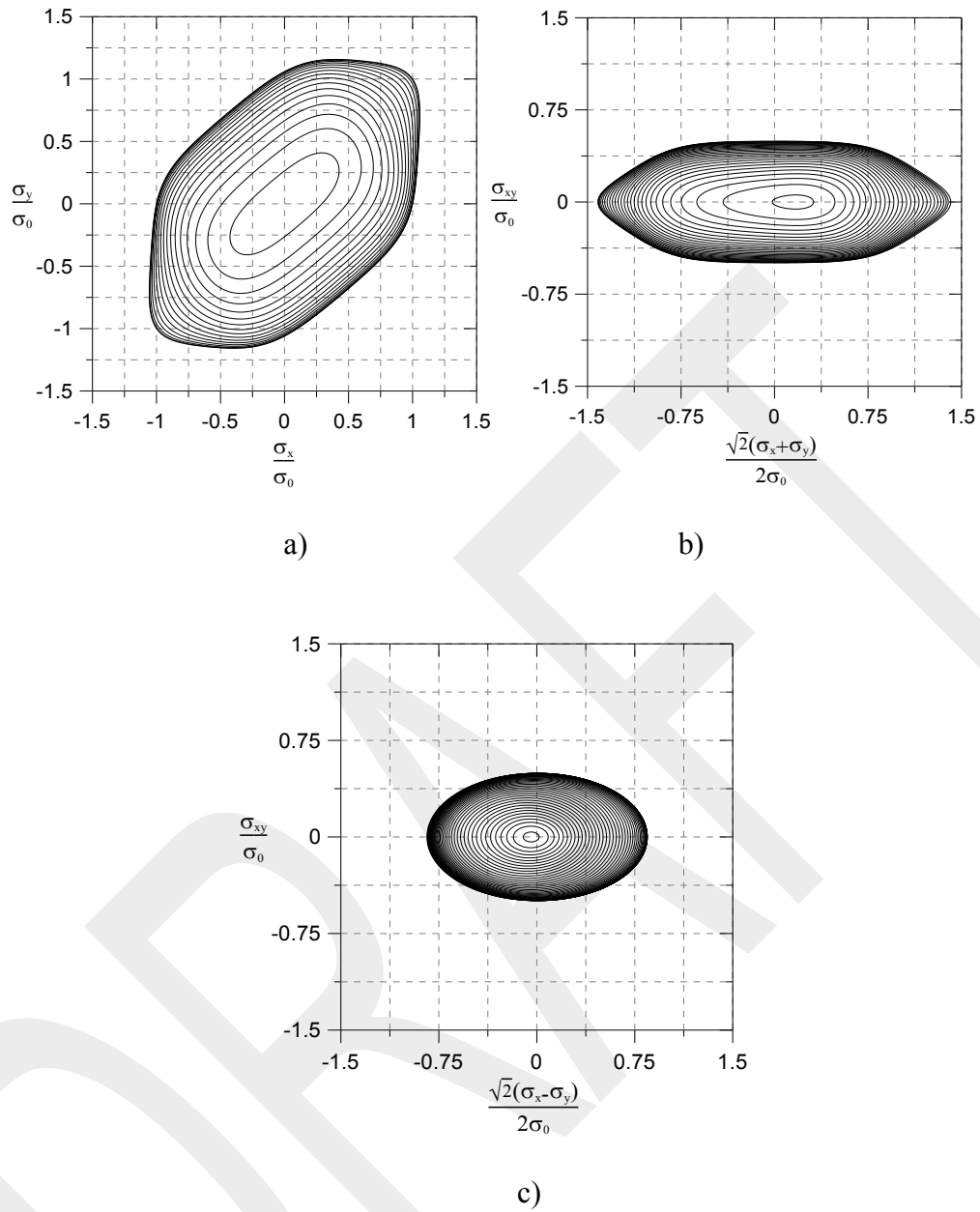

**Figure 135.1.** Contour plots of the yield surface generated from the files a) ‘Contour\_1<#>’, b) ‘Contour\_2<#>’, and c) ‘Contour\_3<#>’.

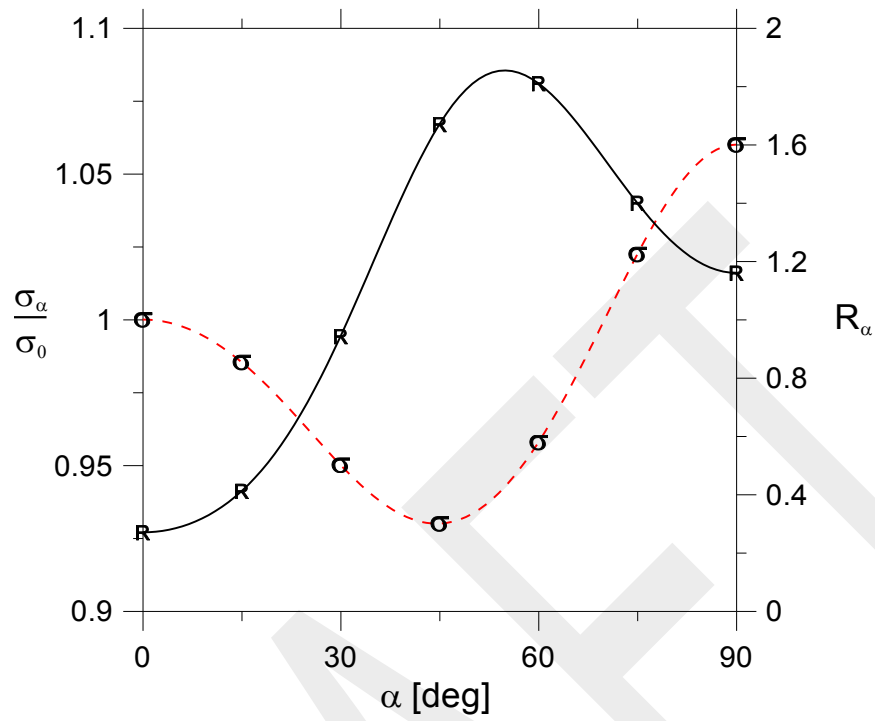

**Figure 135.2.** Predicted directional variation of the yield stress and plastic flow generated from the file 'R\_and\_S<#>'.  
DRAFT

\*MAT\_WTM\_STM\_PLC

This is Material Type 135. This anisotropic material adopts the yield criteria proposed by Aretz [2004]. The material strength is defined by McCormick's constitutive relation for materials exhibiting negative steady-state Strain Rate Sensitivity (SRS). McCormick [1998] and Zhang, McCormick and Estrin [2001].

Card 1            1            2            3            4            5            6            7            8

Variable	MID	RO	E	PR	NUMFI	EPSC	WC	TAUC
Type	A8	F	F	F	F	F	F	F

Card 2            1            2            3            4            5            6            7            8

Variable	SIGMA0	QR1	CR1	QR2	CR2	K		
Type	F	F	F	F	F	F		

Card 3            1            2            3            4            5            6            7            8

Variable	A1	A2	A3	A4	A5	A6	A7	A8
Type	F	F	F	F	F	F	F	F

Card 4            1            2            3            4            5            6            7            8

Variable	S	H	OMEGA	TD	ALPHA	EPS0		
Type	F	F	F	F	F	F		

Card 5            1            2            3            4            5            6            7            8

Variable	AOPT	BETA						
Type	F	F						

Card 6            1            2            3            4            5            6            7            8

Variable	XP	YP	ZP	A1	A2	A3		
Type	F	F	F	F	F	F		

Card 7            1            2            3            4            5            6            7            8

Variable	V1	V2	V3	D1	D2	D3		
Type	F	F	F	F	F	F		

<u>VARIABLE</u>	<u>DESCRIPTION</u>
MID	Material identification. A unique number or label not exceeding 8 characters must be specified.
RO	Mass density
E	Young's modulus
PR	Poisson's ratio
NUMFI	Number of through thickness integration points that must fail before the element is deleted (remember to change this number if switching between full and reduced integration type of elements).
EPSC	Critical value $\epsilon_{IC}$ of the plastic thickness strain.
WC	Critical value $W_c$ for the Cockcroft-Latham fracture criterion.
TAUC	Critical value $\tau_c$ for the shear fracture criterion.



VARIABLE	DESCRIPTION
SIGMA0	Initial yield stress $\sigma_0$
QR1	Isotropic hardening parameter, $Q_{R1}$
CR1	Isotropic hardening parameter, $C_{R1}$
QR2	Isotropic hardening parameter, $Q_{R2}$
CR2	Isotropic hardening parameter, $C_{R2}$
K	$k$ equals half the exponent $m$ for the yield criterion
A1	Yld2003 parameter, $a_1$
A2	Yld2003 parameter, $a_2$
A3	Yld2003 parameter, $a_3$
A4	Yld2003 parameter, $a_4$
A5	Yld2003 parameter, $a_5$
A6	Yld2003 parameter, $a_6$
A7	Yld2003 parameter, $a_7$
A8	Yld2003 parameter, $a_8$
S	Dynamic strain aging parameter, $S$ .
H	Dynamic strain aging parameter, $H$ .
OMEGA	Dynamic strain aging parameter, $\Omega$ .
TD	Dynamic strain aging parameter, $t_d$ .
ALPHA	Dynamic strain aging parameter, $\alpha$ .
EPS0	Dynamic strain aging parameter, $\dot{\epsilon}_0$ .

VARIABLE	DESCRIPTION
AOPT	<p>Material axes option (see Mat_ <i>OPTION</i> TROPIC_ELASTIC for a more complete description)</p> <p>EQ.0.0: Locally orthotropic with material axes determined by element nodes as shown in Figure 2.1, and then rotated about the shell element normal by the angle BETA. Nodes 1, 2 and 4 of an element are identical to the nodes used for the definition of a coordinate system as by *DEFINE_COORDINATE_NODES.</p> <p>EQ.2.0: Globally orthotropic with material axes determined by vectors defined below, as with *DEFINE_COORDINATE_VECTOR.</p> <p>EQ.3.0: Locally orthotropic material axes determined by offsetting the material axes by an angle, BETA, from a line determined by taking the cross product of the vector v with the normal to the plane of the element.</p> <p>LT.0.0: the absolute value of AOPT is a coordinate system ID number (CID on *DEFINE_COORDINATE_NODES, *DEFINE_COORDINATE_SYSTEM or *DEFINE_COORDINATE_VECTOR). Available in R3 version of 971 and later.</p>
BETA	<p>Material angle in degrees for AOPT = 0 and 3, may be overwritten on the element card, see *ELEMENT_SHELL_BETA.</p>
XP YP ZP	<p>Coordinates of point <b>p</b> for AOPT=1.</p>
A1 A2 A3	<p>Components of vector <b>a</b> for AOPT=2.</p>
V1 V2 V3	<p>Components of vector <b>v</b> for AOPT=3.</p>
D1 D2 D3	<p>Components of vector <b>d</b> for AOPT=2.</p>

**Remarks:**

The yield function is defined as

$$f = \bar{f}(\boldsymbol{\sigma}) - \left[ \sigma_Y(t_a) + R(\epsilon_p) + \sigma_v(\dot{\epsilon}^p) \right]$$

where the equivalent stress  $\sigma_{eq}$  is defined as by an anisotropic yield criterion

$$\sigma_{eq} = \left[ \frac{1}{2} \left( |\sigma_1'|^m + |\sigma_2'|^m + |\sigma_1'' - \sigma_2''| \right) \right]^{\frac{1}{m}}$$

where

$$\begin{cases} \sigma'_1 \\ \sigma'_2 \end{cases} = \frac{a_8 \sigma_{xx} + a_1 \sigma_{yy}}{2} \pm \sqrt{\left(\frac{a_2 \sigma_{xx} - a_3 \sigma_{yy}}{2}\right)^2 + a_4^2 \sigma_{xy}^2}$$

and

$$\begin{cases} \sigma''_1 \\ \sigma''_2 \end{cases} = \frac{\sigma_{xx} + \sigma_{yy}}{2} \pm \sqrt{\left(\frac{a_5 \sigma_{xx} - a_6 \sigma_{yy}}{2}\right)^2 + a_7^2 \sigma_{xy}^2}$$

The strain hardening function  $R$  is defined by the extended Voce law

$$R(\varepsilon^p) = \sum_{i=1}^2 Q_{Ri} (1 - \exp(-C_{Ri} \varepsilon^p))$$

Where  $\varepsilon^p$  is the effective (or accumulated) plastic strain, and  $Q_{Ri}$  and  $C_{Ri}$  are strain hardening parameters.

Viscous stress  $\sigma_v$  is given by

$$\sigma_v = (\dot{\varepsilon}^p) = S \ln \left( 1 + \frac{\dot{\varepsilon}^p}{\dot{\varepsilon}_0} \right)$$

Where  $S$  represents the instantaneous strain rate sensitivity (SRS) and  $\dot{\varepsilon}_0$  is a reference strain rate. In this model the yield strength, including the contribution from dynamic strain aging (DSA) is defined as

$$\sigma_Y(t_a) = \sigma_0 + SH \left[ 1 - \exp \left\{ - \left( \frac{t_a}{t_d} \right)^\alpha \right\} \right]$$

Where  $\sigma_0$  is the yield strength for vanishing average waiting time,  $t_a$ , i.e. at high strain rates, and  $H$ ,  $\alpha$  and  $t_d$  are material constants linked to dynamic strain aging. It is noteworthy that  $\sigma_Y$  is an increasing function of  $t_a$ . The average waiting time is defined by the evolution equation

$$\dot{t}_a = 1 - \frac{t_a}{t_{a,ss}}$$

where the quasi-steady waiting time  $t_{a,ss}$  is given as

$$t_{a,ss} = \frac{\Omega}{\dot{\varepsilon}^p}$$

where  $\Omega$  is the strain produced by all mobile dislocations moving to the next obstacle on their path.

**\*MAT\_CORUS\_VEGTER**

This is Material Type 136, a plane stress orthotropic material model for metal forming. Yield surface construction is based on the interpolation by second-order Bezier curves, and model parameters are determined directly from a set of mechanical tests conducted for a number of directions. For each direction, four mechanical tests are carried out: a uniaxial, an equi-biaxial, a plane strain tensile test and a shear test. These test results are used to determine the coefficients of the Fourier directional dependency field. For a more detailed description please see Vegter and Boogaard [2006].

Card 1            1            2            3            4            5            6            7            8

Variable	MID	RO	E	PR	N	FBI	RBI0	LCID
Type	A8	F	F	F	F	F	F	F

Card 2            1            2            3            4            5            6            7            8

Variable	SYS	SIP	SHS	SHL	ESH	E0	ALPHA	LCID2
Type	F	F	F	F	F	F	F	F

Card 3            1            2            3            4            5            6            7            8

Variable	AOPT							
Type								

Card 4            1            2            3            4            5            6            7            8

Variable	XP	YP	ZP	A1	A2	A3		
Type	F	F	F	F	F	F		

Card 5            1            2            3            4            5            6            7            8

Variable	V1	V2	V3	D1	D2	D3	BETA	
Type	F	F	F	F	F	F	F	

**Cards 6 up to N+6 are to define the experimental data obtained from four mechanical**

**tests for a group of equidistantly placed directions  $\theta_i = \frac{i\pi}{2N}$  ( $i = 0, 1, 2, \dots, N$ )**

Card 6            1            2            3            4            5            6            7            8

Variable	FUN-I	RUN-I	FPS1-I	FPS2-I	FSH-I			
Type	F	F	F	F	F			

**VARIABLE****DESCRIPTION**

MID	Material identification. A unique number or label not exceeding 8 characters must be specified.
RO	Material density
E	Elastic Young's modulus
PR	Poisson's ratio
N	Order of Fourier series (i.e., number of test groups minus one). The minimum number for $N$ is 2, and the maximum is 12.
FBI	Normalized yield stress for equibiaxial test.
RBI0	Initial strain ratio for equibiaxial test.
LCID	Stress-strain curve ID. If defined, SYS, SIP, SHS, and SHL are ignored.
SYS	Static yield stress, $\sigma_0$ .
SIP	Stress increment parameter, $\Delta\sigma_m$
SHS	Strain hardening parameter for small strain, $\beta$ .
SHL	Strain hardening parameter for larger strain, $\Omega$ .

VARIABLE	DESCRIPTION
ESH	Exponent for strain hardening, $n$ .
E0	Initial plastic strain
ALPHA	$\alpha$ distribution of hardening used in the curve-fitting. $\alpha = 0$ pure kinematic hardening and $\alpha = 1$ provides pure isotropic hardening.
LCID2	Curve ID. The curve defines Young's modulus change with respect to the plastic strain. By default it is assumed that Young's modulus remains constant. Effective value is between 0-1.
AOPT	Material axes option (see MAT_OPTION TROPIC_ELASTIC for a more complete description): EQ.0.0: locally orthotropic with material axes determined by element nodes 1, 2, and 4, as with *DEFINE_COORDINATE_NODES, and then rotated about the shell element normal by the angle BETA. EQ.2.0: globally orthotropic with material axes determined by vectors defined below, as with *DEFINE_COORDINATE_VECTOR. EQ.3.0: locally orthotropic material axes determined by rotating the material axes about the element normal by an angle, BETA, from a line in the plane of the element defined by the cross product of the vector $\mathbf{v}$ with the element normal. LT.0.0: the absolute value of AOPT is a coordinate system ID number (CID on *DEFINE_COORDINATE_NODES, *DEFINE_COORDINATE_SYSTEM or *DEFINE_COORDINATE_VECTOR). Available in R3 version of 971 and later.
XP YP ZP	Coordinates of point $\mathbf{p}$ for AOPT = 1.
A1 A2 A3	Components of vector $\mathbf{a}$ for AOPT = 2.
V1 V2 V3	Components of vector $\mathbf{v}$ for AOPT = 3
D1 D2 D3	Components of vector $\mathbf{d}$ for AOPT = 2.
BETA	Material angle in degrees for AOPT = 0 and 3, may be overwritten on the element card, see *ELEMENT_SHELL_BETA.
FUN-I	Normalized yield stress for uniaxial test for the $i$ th direction.
RUN-I	Strain ratio for uniaxial test for the $i$ th direction.
FPS1-I	First normalized yield stress for plain strain test for the $i$ th direction.
FPS2-I	Second normalized yield stress for plain strain test for the $i$ th direction.

---

<u>VARIABLE</u>	<u>DESCRIPTION</u>
FSH-I	First normalized yield stress for pure shear test for the ith direction.

**Remarks:**

The yield criterion is chosen as:

$$\sigma_y = \sigma_0 + \Delta\sigma_m \left[ \beta \varepsilon_{eq} + \left( 1 - e^{-\Omega \varepsilon_{eq}} \right)^n \right]$$

**\*MAT\_COHESIVE\_MIXED\_MODE**

This is Material Type 138. This model is a simplification of \*MAT\_COHESIVE\_GENERAL restricted to linear softening. It includes a bilinear traction-separation law with quadratic mixed mode delamination criterion and a damage formulation. It can be used with solid element types 19 and 20, and is not available for other solid element formulations. See the remarks after \*SECTION\_SOLID for a description of element types 19 and 20.

Card 1            1            2            3            4            5            6            7            8

Variable	MID	RO	ROFLG	INTFAIL	EN	ET	GIC	GIIC
Type	A8	F	F	F	F	F	F	F

Card 2            1            2            3            4            5            6            7            8

Variable	XMU	T	S	UND	UTD			
Type	F	F	F	F	F			

<u>VARIABLE</u>	<u>DESCRIPTION</u>
MID	Material identification. A unique number or label not exceeding 8 characters must be specified.
RO	Mass density
ROFLG	Flag for whether density is specified per unit area or volume. ROFLG=0 specified density per unit volume (default), and ROFLG=1 specifies the density is per unit area for controlling the mass of cohesive elements with an initial volume of zero.
INTFAIL	The number of integration points required for the cohesive element to be deleted. If it is zero, the element won't be deleted even if it satisfies the failure criterion. The value of INTFAIL may range from 1 to 4, with 1 the recommended value.
EN	The stiffness (units of stress/length) normal to the plane of the cohesive element.
ET	The stiffness (units of stress/length)) in the plane of the cohesive element.



VARIABLE	DESCRIPTION
GIC	Energy release rate for mode I (units of stress*length)
GIIC	Energy release rate for mode II (units of stress*length)
XMU	Exponent of the mixed mode criteria (see remarks below)
T	Peak traction (stress units) in normal direction LT.0.0: Load curve ID = (-T) which defines peak traction in normal direction as a function of element size. See remarks.
S	Peak traction (stress units) in tangential direction LT.0.0: Load curve ID = (-S) which defines peak traction in tangential direction as a function of element size. See remarks.
UND	Ultimate displacement in the normal direction
UTD	Ultimate displacement in the tangential direction

### Remarks:

The ultimate displacements in the normal and tangential directions are the displacements at the time when the material has failed completely, i.e., the tractions are zero. The linear stiffness for loading followed by the linear softening during the damage provides an especially simple relationship between the energy release rates, the peak tractions, and the ultimate displacements:

$$GIC = T \cdot UND / 2$$

$$GIIC = S \cdot UTD / 2$$

If the peak tractions aren't specified, they are computed from the ultimate displacements. See Fiolka and Matzenmiller [2005] and Gerlach, Fiolka and Matzenmiller [2005].

In this cohesive material model, the total mixed-mode relative displacement  $\delta_m$  is defined as  $\delta_m = \sqrt{\delta_I^2 + \delta_{II}^2}$ , where  $\delta_I = \delta_3$  is the separation in normal direction (mode I) and  $\delta_{II} = \sqrt{\delta_1^2 + \delta_2^2}$  is the separation in tangential direction (mode II). The mixed-mode damage initiation displacement  $\delta^0$  (onset of softening) is given by

$$\delta^0 = \delta_I^0 \delta_{II}^0 \sqrt{\frac{1 + \beta^2}{(\delta_{II}^0)^2 + (\beta \delta_I^0)^2}}$$

where  $\delta_I^0 = T / EN$  and  $\delta_{II}^0 = S / ET$  are the single mode damage initiation separations and  $\beta = \delta_{II} / \delta_I$  is the "mode mixity" (see Figure 138.1). The ultimate mixed-mode displacement  $\delta^f$  (total failure) for the power law (XMU>0) is:

$$\delta^F = \frac{2(1+\beta)^2}{\delta^0} \left[ \left( \frac{EN}{GIC} \right)^{XMU} + \left( \frac{ET \cdot \beta^2}{GIC} \right)^{XMU} \right]^{\frac{1}{XMU}}$$

and alternatively for the Benzeggagh-Kenane law [1996] (XMU<0):

$$\delta^F = \frac{2}{\delta^0 \left( \frac{1}{1+\beta^2} EN + \frac{\beta^2}{1+\beta^2} ET \right)} \left[ GIC + (GIC - GIC) \left( \frac{\beta^2 \cdot ET}{EN + \beta^2 \cdot ET} \right)^{|XMU|} \right]$$

In this model, damage of the interface is considered, i.e. irreversible conditions are enforced with loading/unloading paths coming from/pointing to the origin.

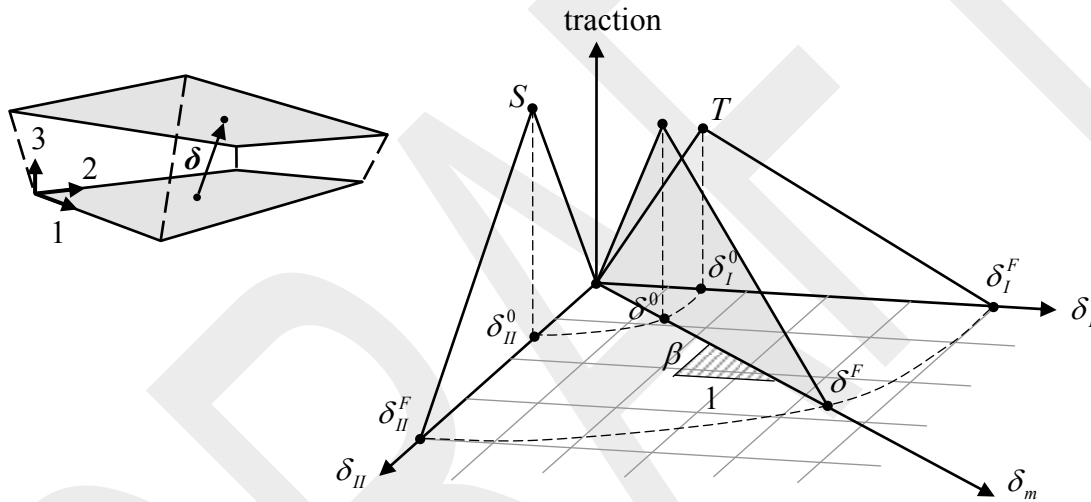

Figure 138.1. Mixed-mode traction-separation law

Peak tractions T and/or S can be defined as functions of characteristic element length (square root of midsurface area) via load curve. This option is useful to get nearly the same global responses (e.g. load-displacement curve) with coarse meshes when compared to a fine mesh solution. In general, lower peak traction values are needed for coarser meshes

Two error checks have been implemented for this material model in order to ensure proper material data. Since the traction versus displacement curve is fairly simple (triangular shaped), equations can be developed to ensure that the displacement (L) at the peak load (QMAX), is smaller than the ultimate distance for failure (u). See Figure 138.2 for the used notation.

One has that

$$GC = \frac{1}{2} u \cdot QMAX \text{ and } L = \frac{QMAX}{E}.$$

To ensure that the peak is not past the failure point,  $\frac{u}{L}$  must be larger than 1.

$$u = \frac{2GC}{EL},$$

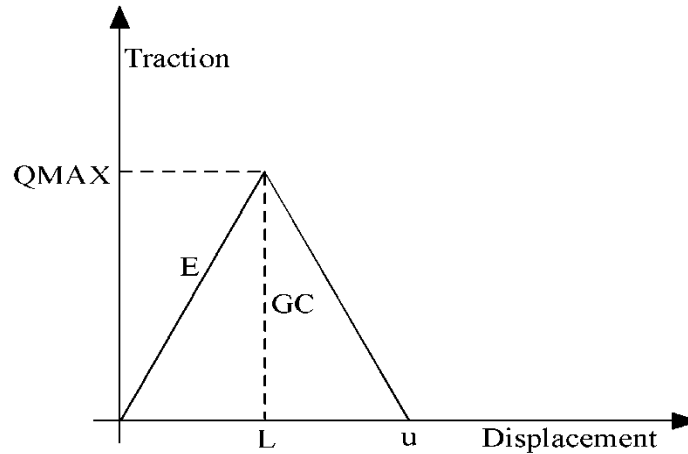

Figure 138.2. Bilinear traction-separation law

where  $GC$  is the energy release rate. This gives

$$\frac{u}{L} = \frac{2GC}{ELL} = \frac{2GC}{E \left( \frac{QMAX}{E} \right)^2} > 1.$$

The error checks are then done for tension and pure shear, respectively,

$$\frac{u}{L} = \frac{(2GIC)}{EN \left( \frac{T}{EN} \right)^2} > 1,$$

$$\frac{u}{L} = \frac{(2GIIC)}{ET \left( \frac{S}{ET} \right)^2} > 1.$$

**\*MAT\_MODIFIED\_FORCE\_LIMITED**

This is Material Type 139. This material for the Belytschko-Schwer resultant beam is an extension of material 29. In addition to the original plastic hinge and collapse mechanisms of material 29, yield moments may be defined as a function of axial force. After a hinge forms, the moment transmitted by the hinge is limited by a moment-plastic rotation relationship.

Card 1            1            2            3            4            5            6            7            8

Variable	MID	RO	E	PR	DF	AOPT	YTFLAG	ASOFT
Type	A8	F	F	F	F	F	F	F
Default	none	none	none	none	0.0	0.0	0.0	0.0

Card 2            1            2            3            4            5            6            7            8

Variable	M1	M2	M3	M4	M5	M6	M7	M8
Type	F	F	F	F	F	F	F	F
Default	none	0	0	0	0	0	0	0

Card 3            1            2            3            4            5            6            7            8

Variable	LC1	LC2	LC3	LC4	LC5	LC6	LC7	LC8
Type	F	F	F	F	F	F	F	F
Default	none	0	0	0	0	0	0	0

Card 4            1            2            3            4            5            6            7            8

Variable	LPS1	SFS1	LPS2	SFS2	YMS1	YMS2		
Type	F	F	F	F	F	F		
Default	0	1.0	LPS1	1.0	1.0E+20	YMS1		

Card 5            1            2            3            4            5            6            7            8

Variable	LPT1	SFT1	LPT2	SFT2	YMT1	YMT2		
Type	F	F	F	F	F	F		
Default	0	1.0	LPT1	1.0	1.0E+20	YMT1		

Card 6            1            2            3            4            5            6            7            8

Variable	LPR	SFR	YMR					
Type	F	F	F					
Default	0	1.0	1.0E+20					

Card 7            1            2            3            4            5            6            7            8

Variable	LYS1	SYS1	LYS2	SYS2	LYT1	SYT1	LYT2	SYT2
Type	F	F	F	F	F	F	F	F
Default	0	1.0	0	1.0	0	1.0	0	1.0

Card 8            1            2            3            4            5            6            7            8

Variable	LYR	SYR						
Type	F	F						
Default	0	1.0						

Card 9            1            2            3            4            5            6            7            8

Variable	HMS1_1	HMS1_2	HMS1_3	HMS1_4	HMS1_5	HMS1_6	HMS1_7	HMS1_8
Type	F	F	F	F	F	F	F	F
Default	0	0	0	0	0	0	0	0

Card 10           1            2            3            4            5            6            7            8

Variable	LPMS1_1	LPMS1_2	LPMS1_3	LPMS1_4	LPMS1_5	LPMS1_6	LPMS1_7	LPMS1_8
Type	F	F	F	F	F	F	F	F
Default	0	0	0	0	0	0	0	0

Card 11           1            2            3            4            5            6            7            8

Variable	HMS2_1	HMS2_2	HMS2_3	HMS2_4	HMS2_5	HMS2_6	HMS2_7	HMS2_8
Type	F	F	F	F	F	F	F	F
Default	0	0	0	0	0	0	0	0

Card 12            1            2            3            4            5            6            7            8

Variable	LPMS2_1	LPMS2_2	LPMS2_3	LPMS2_4	LPMS2_5	LPMS2_6	LPMS2_7	LPMS2_8
Type	F	F	F	F	F	F	F	F
Default	0	0	0	0	0	0	0	0

Card 13            1            2            3            4            5            6            7            8

Variable	HMT1_1	HMT1_2	HMT1_3	HMT1_4	HMT1_5	HMT1_6	HMT1_7	HMT1_8
Type	F	F	F	F	F	F	F	F
Default	0	0	0	0	0	0	0	0

Card 14            1            2            3            4            5            6            7            8

Variable	LPMT1_1	LPMT1_2	LPMT1_3	LPMT1_4	LPMT1_5	LPMT1_6	LPMT1_7	LPMT1_8
Type	F	F	F	F	F	F	F	F
Default	0	0	0	0	0	0	0	0

Card 15            1            2            3            4            5            6            7            8

Variable	HMT2_1	HMT2_2	HMT2_3	HMT2_4	HMT2_5	HMT2_6	HMT2_7	HMT2_8
Type	F	F	F	F	F	F	F	F
Default	0	0	0	0	0	0	0	0

Card 16            1            2            3            4            5            6            7            8

Variable	LPMT2_1	LPMT2_2	LPMT2_3	LPMT2_4	LPMT2_5	LPMT2_6	LPMT2_7	LPMT2_8
Type	F	F	F	F	F	F	F	F
Default	0	0	0	0	0	0	0	0

Card 17            1            2            3            4            5            6            7            8

Variable	HMR_1	HMR_2	HMR_3	HMR_4	HMR_5	HMR_6	HMR_7	HMR_8
Type	F	F	F	F	F	F	F	F
Default	0	0	0	0	0	0	0	0

Card 18            1            2            3            4            5            6            7            8

Variable	LPMR_1	LPMR_2	LPMR_3	LPMR_4	LPMR_5	LPMR_6	LPMR_7	LPMR_8
Type	F	F	F	F	F	F	F	F
Default	0	0	0	0	0	0	0	0

<u>VARIABLE</u>	<u>DESCRIPTION</u>
MID	Material identification. A unique number or label not exceeding 8 characters must be specified.
RO	Mass density
E	Young's modulus
PR	Poisson's ratio
DF	Damping factor, see definition in notes below. A proper control for the timestep has to be maintained by the user!



VARIABLE	DESCRIPTION
AOPT	Axial load curve option: EQ.0.0: axial load curves are force versus strain, EQ.1.0: axial load curves are force versus change in length. LT.0.0: the absolute value of AOPT is a coordinate system ID number (CID on *DEFINE_COORDINATE_NODES, *DEFINE_COORDINATE_SYSTEM or *DEFINE_COORDINATE_VECTOR). Available in R3 version of 971 and later.
YTFLAG	Flag to allow beam to yield in tension: EQ.0.0: beam does not yield in tension, EQ.1.0: beam can yield in tension.
ASOFT	Axial elastic softening factor applied once hinge has formed. When a hinge has formed the stiffness is reduced by this factor. If zero, this factor is ignored.
M1, M2,...,M8	Applied end moment for force versus (strain/change in length) curve. At least one must be defined. A maximum of 8 moments can be defined. The values should be in ascending order.
LC1, LC2,...,LC8	Load curve ID (see *DEFINE_CURVE) defining axial force versus strain/change in length (see AOPT) for the corresponding applied end moment. Define the same number as end moments. Each curve must contain the same number of points.
LPS1	Load curve ID for plastic moment versus rotation about s-axis at node 1. If zero, this load curve is ignored.
SFS1	Scale factor for plastic moment versus rotation curve about s-axis at node 1. Default = 1.0.
LPS2	Load curve ID for plastic moment versus rotation about s-axis at node 2. Default: is same as at node 1.
SFS2	Scale factor for plastic moment versus rotation curve about s-axis at node 2. Default: is same as at node 1.
YMS1	Yield moment about s-axis at node 1 for interaction calculations (default set to 1.0E+20 to prevent interaction).
YMS2	Yield moment about s-axis at node 2 for interaction calculations (default set to YMS1).
LPT1	Load curve ID for plastic moment versus rotation about t-axis at node 1. If zero, this load curve is ignored.

<u>VARIABLE</u>	<u>DESCRIPTION</u>
SFT1	Scale factor for plastic moment versus rotation curve about t-axis at node 1. Default = 1.0.
LPT2	Load curve ID for plastic moment versus rotation about t-axis at node 2. Default: is the same as at node 1.
SFT2	Scale factor for plastic moment versus rotation curve about t-axis at node 2. Default: is the same as at node 1.
YMT1	Yield moment about t-axis at node 1 for interaction calculations (default set to 1.0E+20 to prevent interactions)
YMT2	Yield moment about t-axis at node 2 for interaction calculations (default set to YMT1)
LPR	Load curve ID for plastic torsional moment versus rotation. If zero, this load curve is ignored.
SFR	Scale factor for plastic torsional moment versus rotation (default = 1.0).
YMR	Torsional yield moment for interaction calculations (default set to 1.0E+20 to prevent interaction)
LYS1	ID of curve defining yield moment as a function of axial force for the s-axis at node 1.
SYS1	Scale factor applied to load curve LYS1.
LYS2	ID of curve defining yield moment as a function of axial force for the s-axis at node 2.
SYS2	Scale factor applied to load curve LYS2.
LYT1	ID of curve defining yield moment as a function of axial force for the t-axis at node 1.
SYT1	Scale factor applied to load curve LYT1.
LYT2	ID of curve defining yield moment as a function of axial force for the t-axis at node 2.
SYT2	Scale factor applied to load curve LYT2.
LYR	ID of curve defining yield moment as a function of axial force for the torsional axis.
SYR	Scale factor applied to load curve LYR.

<u>VARIABLE</u>	<u>DESCRIPTION</u>
HMS1_n	Hinge moment for s-axis at node 1.
LPMS1_n	ID of curve defining plastic moment as a function of plastic rotation for the s-axis at node 1 for hinge moment HMS1_n
HMS2_n	Hinge moment for s-axis at node 2.
LPMS2_n	ID of curve defining plastic moment as a function of plastic rotation for the s-axis at node 2 for hinge moment HMS2_n
HMT1_n	Hinge moment for t-axis at node 1.
LPMT1_n	ID of curve defining plastic moment as a function of plastic rotation for the t-axis at node 1 for hinge moment HMT1_n
HMT2_n	Hinge moment for t-axis at node 2.
LPMT2_n	ID of curve defining plastic moment as a function of plastic rotation for the t-axis at node 2 for hinge moment HMT2_n
HMR_n	Hinge moment for the torsional axis.
LPMR_n	ID of curve defining plastic moment as a function of plastic rotation for the torsional axis for hinge moment HMR_n

**Remarks:**

This material model is available for the Belytschko resultant beam element only. Plastic hinges form at the ends of the beam when the moment reaches the plastic moment. The plastic moment versus rotation relationship is specified by the user in the form of a load curve and scale factor. The points of the load curve are (plastic rotation in radians, plastic moment). Both quantities should be positive for all points, with the first point being (zero, initial plastic moment). Within this constraint any form of characteristic may be used, including flat or falling curves. Different load curves and scale factors may be specified at each node and about each of the local s and t axes.

Axial collapse occurs when the compressive axial load reaches the collapse load. Collapse load versus collapse deflection is specified in the form of a load curve. The points of the load curve are either (true strain, collapse force) or (change in length, collapse force). Both quantities should be entered as positive for all points, and will be interpreted as compressive. The first point should be (zero, initial collapse load).

The collapse load may vary with end moment as well as with deflections. In this case several load-deflection curves are defined, each corresponding to a different end moment. Each load curve should have the same number of points and the same deflection values. The end moment is defined as the average of the absolute moments at each end of the beam and is always positive.

Stiffness-proportional damping may be added using the damping factor  $\lambda$ . This is defined as follows:

$$\lambda = \frac{2 * \xi}{\omega}$$

where  $\xi$  is the damping factor at the reference frequency  $\omega$  (in radians per second). For example if 1% damping at 2Hz is required

$$\lambda = \frac{2 * 0.01}{2\pi * 2} = 0.001592$$

If damping is used, a small time step may be required. LS-DYNA does not check this so to avoid instability it may be necessary to control the time step via a load curve. As a guide, the time step required for any given element is multiplied by  $0.3L/c\lambda$  when damping is present ( $L$  = element length,  $c$  = sound speed).

### **Moment Interaction:**

Plastic hinges can form due to the combined action of moments about the three axes. This facility is activated only when yield moments are defined in the material input. A hinge forms when the following condition is first satisfied.

$$\left( \frac{M_r}{M_{ryield}} \right)^2 + \left( \frac{M_s}{M_{syield}} \right)^2 + \left( \frac{M_t}{M_{tyield}} \right)^2 \geq 1$$

where,

$M_r, M_s, M_t$  = current moment

$M_{ryield}, M_{syield}, M_{tyield}$  = yield moment

Note that scale factors for hinge behavior defined in the input will also be applied to the yield moments: for example,  $M_{syield}$  in the above formula is given by the input yield moment about the local axis times the input scale factor for the local s axis. For strain-softening characteristics, the yield moment should generally be set equal to the initial peak of the moment-rotation load curve.

On forming a hinge, upper limit moments are set. These are given by

$$M_{r_{upper}} = MAX \left( M_r, \frac{M_{ryield}}{2} \right)$$

and similar for  $M_s$  and  $M_t$ .

Thereafter the plastic moments will be given by

$$M_{rp} = \min (M_{rupper}, M_{rcurve}) \text{ and similar for s and t}$$

where

$M_{rp}$  = current plastic moment

$M_{rcurve}$  = moment taken from load curve at the current rotation scaled according to the scale factor.

The effect of this is to provide an upper limit to the moment that can be generated; it represents the softening effect of local buckling at a hinge site. Thus if a member is bent about its local s-axis it will then be weaker in torsion and about its local t-axis. For moments-softening curves, the effect is to trim off the initial peak (although if the curves subsequently harden, the final hardening will also be trimmed off).

It is not possible to make the plastic moment vary with the current axial load, but it is possible to make hinge formation a function of axial load and subsequent plastic moment a function of the moment at the time the hinge formed. This is discussed in the next section.

#### **Independent plastic hinge formation:**

In addition to the moment interaction equation, Cards 7 through 18 allow plastic hinges to form independently for the s-axis and t-axis at each end of the beam and also for the torsional axis. A plastic hinge is assumed to form if any component of the current moment exceeds the yield moment as defined by the yield moment vs. axial force curves input on cards 7 and 8. If any of the 5 curves is omitted, a hinge will not form for that component. The curves can be defined for both compressive and tensile axial forces. If the axial force falls outside the range of the curve, the first or last point in the curve will be used. A hinge forming for one component of moment does not effect the other components.

Upon forming a hinge, the magnitude of that component of moment will not be permitted to exceed the current plastic moment. The current plastic moment is obtained by interpolating between the plastic moment vs. plastic rotation curves input on cards 10, 12, 14, 16, or 18. Curves may be input for up to 8 hinge moments, where the hinge moment is defined as the yield moment at the time that the hinge formed. Curves must be input in order of increasing hinge moment and each curve should have the same plastic rotation values. The first or last curve will be used if the hinge moment falls outside the range of the curves. If no curves are defined, the plastic moment is obtained from the curves on cards 4 through 6. The plastic moment is scaled by the scale factors on lines 4 to 6.

A hinge will form if either the independent yield moment is exceeded or if the moment interaction equation is satisfied. If both are true, the plastic moment will be set to the minimum of the interpolated value and  $M_{rp}$ .

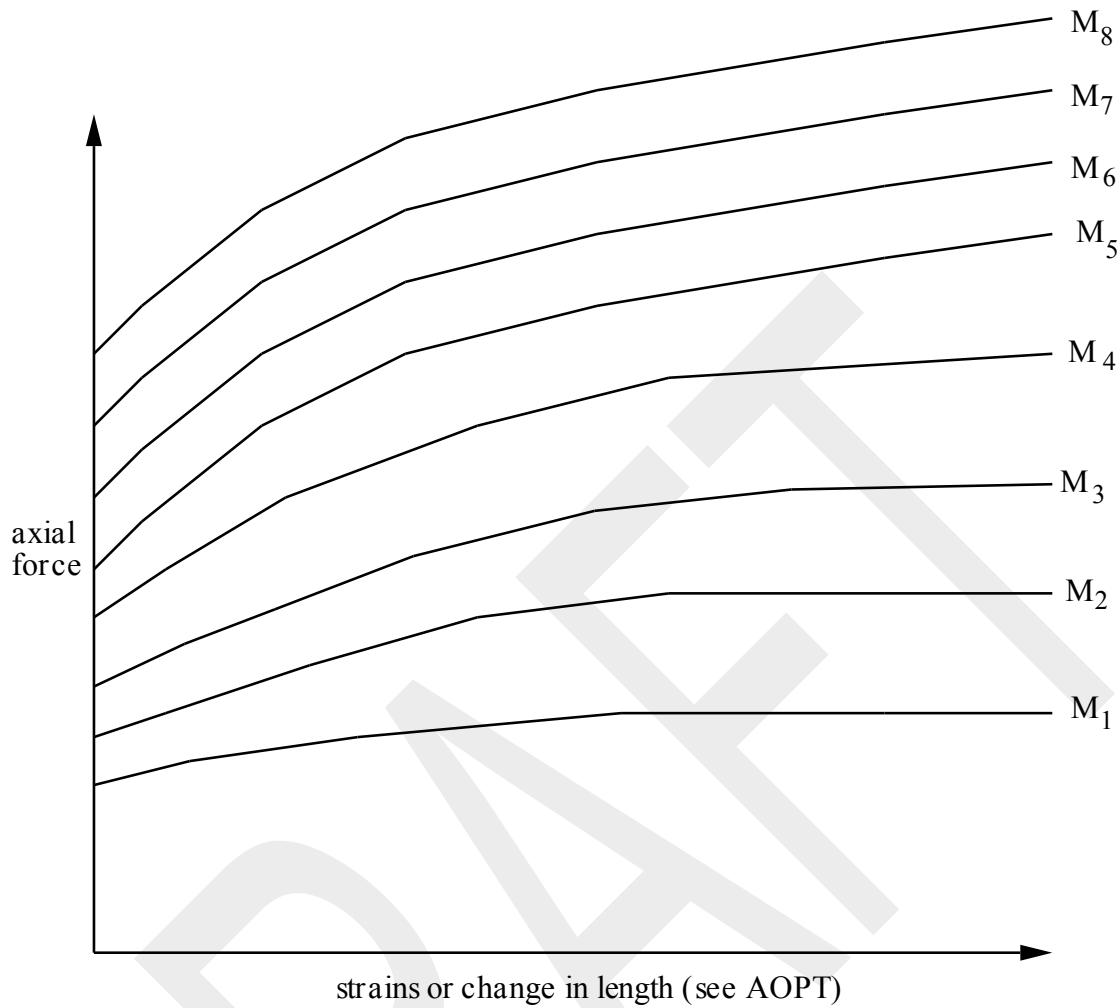

**Figure 139.1.** The force magnitude is limited by the applied end moment. For an intermediate value of the end moment LS-DYNA interpolates between the curves to determine the allowable force value.

\*MAT\_VACUUM

This is Material Type 140. This model is a dummy material representing a vacuum in a multi-material Euler/ALE model. Instead of using ELFORM=12 (under \*SECTION\_SOLID), it is better to use ELFORM=11 with the void material defined as vacuum material instead.

Card 1            1            2            3            4            5            6            7            8

Variable	MID	RHO							
Type	A8	F							

<u>VARIABLE</u>	<u>DESCRIPTION</u>
MID	Material identification. A unique number or label not exceeding 8 characters must be specified.
RHO	Estimated material density. This is used only as stability check.

**Remarks:**

1. The vacuum density is estimated. It should be small relative to air in the model (possibly at least  $10^3$  to  $10^6$  lighter than air).

**\*MAT\_RATE\_SENSITIVE\_POLYMER**

This is Material Type 141. This model is for the simulation of an isotropic ductile polymer with strain rate effects [Stouffer and Dame 1996]. Uniaxial test data has to be used.

Card 1            1            2            3            4            5            6            7            8

Variable	MID	RO	E	PR	Do	N	Zo	q
Type	A8	F	F	F	F	F	F	F

Card 2            1            2            3            4            5            6            7            8

Variable	Omega							
Type	F							

<u>VARIABLE</u>	<u>DESCRIPTION</u>
MID	Material identification. A unique number or label not exceeding 8 characters must be specified.
RO	Mass density
E	Elastic modulus.
PR	Poisson's ratio
Do	Reference strain rate (=1000*max strain rate used in the test).
N	Exponent (see inelastic strain rate equation below)
Zo	Initial hardness of material
q	(see equations below).
Omega	Maximum internal stress.



**Remarks:**

$$\varepsilon_{ij} = D_o \exp \left[ -0.5 \left( \frac{Z_o^2}{3K_2} \right) \right] \left( \frac{S_{ij} - \Omega_{ij}}{\sqrt{K_2}} \right)$$

where the  $K_2$  term is defined as follows:

$$K_2 = 0.5(S_{ij} - \Omega_{ij})(S_{ij} - \Omega_{ij})$$

and represent the second invariant of the overstress tensor. The elastic components of the strain are added to the inelastic strain to obtain the total strain. The following relationship defines the internal stress variable rate:

$$\dot{\Omega}_{ij} = \frac{2}{3} q \Omega_m \dot{\varepsilon}_{ij}^I - q \Omega_{ij} \dot{\varepsilon}_e^I$$

where  $q$  is a material constant,  $\Omega_m$  is a material constant that represents the maximum value of the internal stress, and  $\dot{\varepsilon}_e^I$  is the effective inelastic strain.

**\*MAT\_TRANSVERSELY\_ISOTROPIC\_CRUSHABLE\_FOAM**

This is Material Type 142. This model is for an extruded foam material that is transversely isotropic, crushable, and of low density with no significant Poisson effect. This material is used in energy-absorbing structures to enhance automotive safety in low velocity (bumper impact) and medium high velocity (interior head impact and pedestrian safety) applications. The formulation of this foam is due to Hirth, Du Bois, and Weimar and is documented by Du Bois [2001]. This model behaves in a more physical way for off axis loading the material, \*MAT\_HONEYCOMB, which can exhibit nonphysical stiffening for loading conditions that are off axis. The load curves are used to define a yield surface that bounds the deviatoric stress tensor.

Card 1            1            2            3            4            5            6            7            8

Variable	MID	RO	E11	E22	E12	E23	G	K
Type	A8	F	F	F	F	F	F	

Card 2            1            2            3            4            5            6            7            8

Variable	I11	I22	I12	I23	IAA	NY	ANG	MU
Type	I	I	I	I	I	I	F	F

Card 3            1            2            3            4            5            6            7            8

Variable	AOPT	ISCL	MACF					
Type	F	I	I					

Card 4            1            2            3            4            5            6            7            8

Variable	XP	YP	ZP	A1	A2	A3		
Type	F	F	F	F	F	F		

Card 5            1            2            3            4            5            6            7            8

Variable	D1	D2	D3	V1	V2	V3		
Type	F	F	F	F	F	F		

<u>VARIABLE</u>	<u>DESCRIPTION</u>
MID	Material identification. A unique number or label not exceeding 8 characters must be specified.
RO	Mass density
E11	Elastic modulus in axial direction.
E22	Elastic modulus in transverse direction (E22=E33).
E12	Elastic shear modulus (E12=E31).
E23	Elastic shear modulus in transverse plane.
G	Shear modulus.
K	Bulk modulus for contact stiffness.
I11	Load curve for nominal axial stress versus volumetric strain.
I22	Load curve ID for nominal transverse stresses versus volumetric strain (I22=I33).
I12	Load curve ID for shear stress component 12 and 31 versus volumetric strain (I12=I31).
I23	Load curve ID for shear stress component 23 versus volumetric strain.
IAA	Load curve ID (optional) for nominal stress versus volumetric strain for load at angle, ANG, relative to the material axis.
NY	Set to unity for a symmetric yield surface.
ANG	Angle corresponding to load curve ID, IAA.

<u>VARIABLE</u>	<u>DESCRIPTION</u>
MU	Damping coefficient for tensor viscosity which acts in both tension and compression. Recommended values vary between 0.05 to 0.10. If zero, tensor viscosity is not used, but bulk viscosity is used instead. Bulk viscosity creates a pressure as the element compresses that is added to the normal stresses, which can have the effect of creating transverse deformations when none are expected.
AOPT	Material axes option (see MAT_OPTION TROPIC_ELASTIC for a more complete description): EQ.0.0: locally orthotropic with material axes determined by element nodes as shown in Figure 2.1. Nodes 1, 2, and 4 of an element are identical to the nodes used for the definition of a coordinate system as by *DEFINE_COORDINATE_NODES. EQ.1.0: locally orthotropic with material axes determined by a point in space and the global location of the element center; this is the a-direction. This option is for solid elements only. EQ.2.0: globally orthotropic with material axes determined by vectors defined below, as with *DEFINE_COORDINATE_VECTOR. EQ.3.0: locally orthotropic material axes determined by rotating the material axes about the element normal by an angle, BETA, from a line in the plane of the element defined by the cross product of the vector <b>v</b> with the element normal. The plane of a solid element is the midsurface between the inner surface and outer surface defined by the first four nodes and the last four nodes of the connectivity of the element, respectively. EQ.4.0: locally orthotropic in cylindrical coordinate system with the material axes determined by a vector <b>v</b> , and an originating point, <b>P</b> , which define the centerline axis. This option is for solid elements only. LT.0.0: the absolute value of AOPT is a coordinate system ID number (CID on *DEFINE_COORDINATE_NODES, *DEFINE_COORDINATE_SYSTEM or *DEFINE_COORDINATE_VECTOR). Available in R3 version of 971 and later.
ISCL	Load curve ID for the strain rate scale factor versus the volumetric strain rate. The yield stress is scaled by the value specified by the load curve.
MACF	Material axes change flag: EQ.1: No change, default, EQ.2: switch material axes a and b, EQ.3: switch material axes a and c, EQ.4: switch material axes b and c.
XP YP ZP	Coordinates of point <b>p</b> for AOPT = 1 and 4.

---

<u>VARIABLE</u>	<u>DESCRIPTION</u>
A1 A2 A3	Components of vector <b>a</b> for AOPT = 2.
D1 D2 D3	Components of vector <b>d</b> for AOPT = 2.
V1 V2 V3	Define components of vector <b>v</b> for AOPT = 3 and 4.

**Remarks:**

Tensor viscosity, which is activated by a nonzero value for MU, is generally more stable than bulk viscosity. A damping coefficient less than 0.01 has little effect, and a value greater than 0.10 may cause numerical instabilities.

**\*MAT\_WOOD\_{OPTION}**

This is Material Type 143. This is a transversely isotropic material and is available for solid elements. The user has the option of inputting his or her own material properties (<BLANK>), or requesting default material properties for Southern yellow pine (**PINE**) or Douglas fir (**FIR**). This model was developed by Murray [2002] under a contract from the FHWA.

Available options include:

**<BLANK>**

**PINE**

**FIR**

Card 1            1            2            3            4            5            6            7            8

Variable	MID	RO	NPLOT	ITERS	IRATE	GHARD	IFAIL	IVOL
Type	A8	F	I	I	I	F	I	I

**Define the following card for the PINE and FIR options.**

Card 2            1            2            3            4            5            6            7            8

Variable	MOIS	TEMP	QUAL_T	QUAL_C	UNITS	IQUAL		
Type	F	F	F	F	I	I		

**Define the following cards, 2-6, for the <BLANK> option.**

Card 2            1            2            3            4            5            6            7            8

Variable	EL	ET	GLT	GTR	PR			
Type	F	F	F	F	F			

Card 3            1            2            3            4            5            6            7            8

Variable	XT	XC	YT	YC	SXY	SYZ		
Type	F	F	F	F	F	F		

Card 4            1            2            3            4            5            6            7            8

Variable	GF1	GF2	BFIT	DMAX	GF1 <sup>⊥</sup>	GF2 <sup>⊥</sup>	DFIT	DMAX <sup>⊥</sup>
Type	F	F	F	F	F	F	F	F

Card 5            1            2            3            4            5            6            7            8

Variable	FLPAR	FLPARC	POWPAR	FLPER	FLPERC	POWPER		
Type	F	F	F	F	F	F		

Card 6            1            2            3            4            5            6            7            8

Variable	NPAR	CPAR	NPER	CPER				
Type	F	F	F	F				

**Define the following three cards for all options.**

Card 3/7            1            2            3            4            5            6            7            8

Variable	AOPT	MACF	BETA					
Type	F	I	F					

Card 4/8      1          2          3          4          5          6          7          8

Variable	XP	YP	ZP	A1	A2	A3		
Type	F	F	F	F	F	F		

Card 5/9      1          2          3          4          5          6          7          8

Variable	D1	D2	D3	V1	V2	V3		
Type	F	F	F	F	F	F		

<u>VARIABLE</u>	<u>DESCRIPTION</u>
MID	Material identification. A unique number or label not exceeding 8 characters must be specified.
RO	Mass density
NPLOT	Controls what is written as component 7 to the d3plot database. LS-PrePost always blindly labels this component as effective plastic strain.: EQ.1: Parallel damage (default). EQ.2: Perpendicular damage.
ITERS	Number of plasticity algorithm iterations. The default is one iteration.
IRATE	Rate effects option: EQ.0: Rate effects model turned off (default). EQ.1: Rate effects model turned on.
GHARD	Perfect plasticity override. Values greater than or equal to zero are allowed. Positive values model late time hardening in compression (an increase in strength with increasing strain). A zero value models perfect plasticity (no increase in strength with increasing strain). The default is zero.
IFAIL	Erosion perpendicular to the grain. EQ.0: No (default). EQ.1: Yes (not recommended except for debugging).



VARIABLE	DESCRIPTION
IVOL	Flag to invoke erosion based on negative volume or strain increments greater than 0.01. EQ.0: No, do not apply erosion criteria. EQ.1: Yes, apply erosion criteria.
MOIS	Percent moisture content. If left blank, moisture content defaults to saturated at 30%.
TEMP	Temperature in °C. If left blank, temperature defaults to room temperature at 20 °C
QUAL_T	Quality factor options. These quality factors reduce the clear wood tension, shear, and compression strengths as a function of grade. EQ.0: Grade 1, 1D, 2, 2D. Predefined strength reduction factors are: Pine: Qual_T=0.47 in tension/shear. Qual_C=0.63 in compression. Fir: Qual_T=0.40 in tension/shear Qual_C=0.73 in compression. EQ.-1: DS-65 or SEI STR (pine and fir). Predefined strength reduction factors are: Qual_T=0.80 in tension/shear. Qual_C=0.93 in compression. EQ.-2: Clear wood. No strength reduction factors are applied: Qual_T=1.0. Qual_C=1.0. GT.0: User defined quality factor in tension. Values between 0 and 1 are expected. Values greater than one are allowed, but may not be realistic.
QUAL_C	User defined quality factor in compression. This input value is used if Qual_T>0. Values between 0 and 1 are expected. Values greater than one are allowed, but may not be realistic. If left blank, a default value of Qual_C=Qual_T is used.
UNITS	Units options: EQ.0: GPa, mm, msec, Kg/mm <sup>3</sup> , kN. EQ.1: MPa, mm, msec, g/mm <sup>3</sup> , Nt. EQ.2: MPa, mm, sec, Mg/mm <sup>3</sup> , Nt. EQ.3: Psi, inch, sec, lb-s <sup>2</sup> /inch <sup>4</sup> , lb
IQUAL	Apply quality factors perpendicular to the grain: EQ.0: Yes (default). EQ 1: No.

<b>VARIABLE</b>	<b>DESCRIPTION</b>
EL	Parallel normal modulus
ET	Perpendicular normal modulus.
GLT	Parallel shear modulus (GLT=GLR).
GTR	Perpendicular shear modulus.
PR	Parallel major Poisson's ratio.
XT	Parallel tensile strength.
XC	Parallel compressive strength.
YT	Perpendicular tensile strength.
YC	Perpendicular compressive strength.
SXY	Parallel shear strength.
SYZ	Perpendicular shear strength.
GF1	Parallel fracture energy in tension.
GF2	Parallel fracture energy in shear.
BFIT	Parallel softening parameter.
DMAX	Parallel maximum damage.
GF1⊥	Perpendicular fracture energy in tension.
GF2⊥	Perpendicular fracture energy in shear.
DFIT	Perpendicular softening parameter.
DMAX⊥	Perpendicular maximum damage.
FLPAR	Parallel fluidity parameter for tension and shear.
FLPARC	Parallel fluidity parameter for compression.
POWPAR	Parallel power.
FLPER	Perpendicular fluidity parameter for tension and shear.
FLPERC	Perpendicular fluidity parameter for compression.

VARIABLE	DESCRIPTION
POWPER	Perpendicular power.
NPAR	Parallel hardening initiation.
CPAR	Parallel hardening rate
NPER	Perpendicular hardening initiation.
CPER	Perpendicular hardening rate.
AOPT	<p>Material axes option (see MAT_OPTION TROPIC_ELASTIC for a more complete description):</p> <p>EQ.0.0: locally orthotropic with material axes determined by element nodes as shown in Figure 2.1. Nodes 1, 2, and 4 of an element are identical to the nodes used for the definition of a coordinate system as by *DEFINE_COORDINATE_NODES.</p> <p>EQ.1.0: locally orthotropic with material axes determined by a point in space and the global location of the element center; this is the a-direction. This option is for solid elements only.</p> <p>EQ.2.0: globally orthotropic with material axes determined by vectors defined below, as with *DEFINE_COORDINATE_VECTOR.</p> <p>EQ.3.0: locally orthotropic material axes determined by rotating the material axes about the element normal by an angle, BETA, from a line in the plane of the element defined by the cross product of the vector <math>\mathbf{v}</math> with the element normal. The plane of a solid element is the midsurface between the inner surface and outer surface defined by the first four nodes and the last four nodes of the connectivity of the element, respectively.</p> <p>EQ.4.0: locally orthotropic in cylindrical coordinate system with the material axes determined by a vector <math>\mathbf{v}</math>, and an originating point, P, which define the centerline axis. This option is for solid elements only.</p> <p>LT.0.0: the absolute value of AOPT is a coordinate system ID number (CID on *DEFINE_COORDINATE_NODES, *DEFINE_COORDINATE_SYSTEM or *DEFINE_COORDINATE_VECTOR). Available in R3 version of 971 and later.</p>
MACF	<p>Material axes change flag:</p> <p>EQ.1: No change, default,</p> <p>EQ.2: switch material axes a and b,</p> <p>EQ.3: switch material axes a and c,</p> <p>EQ.4: switch material axes b and c.</p>
BETA	Material angle in degrees for AOPT = 3, may be overridden on the element card, see *ELEMENT_SOLID_ORTHO.

---

<u>VARIABLE</u>	<u>DESCRIPTION</u>
XP YP ZP	Coordinates of point <b>p</b> for AOPT = 1 and 4.
A1 A2 A3	Components of vector <b>a</b> for AOPT = 2.
D1 D2 D3	Components of vector <b>d</b> for AOPT = 2.
V1 V2 V3	Define components of vector <b>v</b> for AOPT = 3 and 4.

**Remarks:**

Material property data is for clear wood (small samples without defects like knots), whereas real structures are composed of graded wood. Clear wood is stronger than graded wood. Quality factors (strength reduction factors) are applied to the clear wood strengths to account for reductions in strength as a function of grade. One quality factor (Qual\_T) is applied to the tensile and shear strengths. A second quality factor (Qual\_C) is applied to the compressive strengths. As a option, predefined quality factors are provided based on correlations between LS-DYNA calculations and test data for pine and fir posts impacted by bogie vehicles. By default, quality factors are applied to both the parallel and perpendicular to the grain strengths. An option is available (IQUAL) to eliminate application perpendicular to the grain.

\*MAT\_PITZER\_CRUSHABLE\_FOAM

This is Material Type 144. This model is for the simulation of isotropic crushable forms with strain rate effects. Uniaxial and triaxial test data have to be used. For the elastic response, the Poisson ratio is set to zero.

Card 1            1            2            3            4            5            6            7            8

Variable	MID	RO	K	G	PR	TY	SRTV	
Type	A8	F	F	F	F	F	F	

Card 2            1            2            3            4            5            6            7            8

Variable	LCPY	LCUYS	LCSR	VC	DFLG			
Type	I	I	I	F	F			

<u>VARIABLE</u>	<u>DESCRIPTION</u>
MID	Material identification. A unique number or label not exceeding 8 characters must be specified.
RO	Mass density
K	Bulk modulus.
G	Shear modulus
PR	Poisson's ratio
TY	Tension yield.
SRTV	Young's modulus (E)
LCPY	Load curve ID giving pressure versus volumetric strain, see Figure 75.1.
LCUYS	Load curve ID giving uniaxial stress versus volumetric strain, see Figure 75.1.
LCSR	Load curve ID giving strain rate scale factor versus volumetric strain rate.

---

<u>VARIABLE</u>	<u>DESCRIPTION</u>
VC	Viscous damping coefficient (.05 <recommended value < .50).
DFLG	Density flag: EQ.0.0: use initial density EQ.1.0: use current density (larger step size with less mass scaling).

**Remarks:**

The logarithmic volumetric strain is defined in terms of the relative volume,  $V$ , as:

$$\gamma = -\ln(V)$$

In defining the curves the stress and strain pairs should be positive values starting with a volumetric strain value of zero.

## \*MAT\_SCHWER\_MURRAY\_CAP\_MODEL

This is Material Type 145. The Schwer & Murray Cap Model, known as the Continuous Surface Cap Model, is a three invariant extension of the Geological Cap Model (Material Type 25) that also includes viscoplasticity for rate effects and damage mechanics to model strain softening. The primary references are Schwer and Murray [1994], Schwer [1994], and Murray and Lewis [1994]. The model is appropriate for geomaterials including soils, concrete, and rocks.

*Warning:* no default input parameter values are assumed, but recommendations for the more obscure parameters are provided in the descriptions that follow.

Card 1            1            2            3            4            5            6            7            8

Variable	MID	RO	SHEAR	BULK	GRUN	SHOCK	PORE	
Type	A8	F	F	F	F	F	F	

Card 2            1            2            3            4            5            6            7            8

Variable	ALPHA	THETA	GAMMA	BETA	EFIT	FFIT	ALPHAN	CALPHA
Type	F	F	F	F	F	F	F	F

Card 3            1            2            3            4            5            6            7            8

Variable	RO	XO	IROCK	SECP	AFIT	BFIT	RDAMO	
Type	F	F	F	F	F	F	F	

Card 4            1            2            3            4            5            6            7            8

Variable	W	D1	D2	NPLOT	EPSMAX	CFIT	DFIT	TFAIL
Type	F	F	F	F	F	F	F	F

Card 5            1            2            3            4            5            6            7            8

Variable	FAILFL	DBETA	DDELTA	VPTAU				
Type	F	F	F	F				

Card 6            1            2            3            4            5            6            7            8

Variable	ALPHA1	THETA1	GAMMA1	BETA1	ALPHA2	THETA2	GAMMA2	BETA2
Type	F	F	F	F	F	F	F	F

<u>VARIABLE</u>	<u>DESCRIPTION</u>
MID	Material identification. A unique number or label not exceeding 8 characters must be specified.
RO	Mass density
SHEAR	Shear modulus, G
BULK	Bulk modulus, K
GRUN	Gruneisen ratio (typically = 0), $\Gamma$
SHOCK	Shock velocity parameter (typically 0), $S_1$
PORE	Flag for pore collapse EQ.0.0: for Pore collapse EQ.1.0: for Constant bulk modulus (typical)
ALPHA	Shear failure parameter, $\alpha$
THETA	Shear failure parameter, $\theta$
GAMMA	Shear failure parameter, $\gamma$
BETA	Shear failure parameter, $\beta$ $\sqrt{J'_2} = F_e(J_1) = \alpha - \gamma \exp(-\beta J_1) + \theta J_1$
EFIT	Dilataion damage mechanics parameter (no damage = 1)



VARIABLE	DESCRIPTION
FFIT	Dilatation damage mechanics parameter (no damage = 0)
ALPHAN	Kinematic strain hardening parameter, $N^\alpha$
CALPHAN	Kinematic strain hardening parameter, $c^\alpha$
R0	Initial cap surface ellipticity, R
X0	Initial cap surface $J_1$ (mean stress) axis intercept, $X(\kappa_0)$
IROCK	EQ.0: soils (cap can contract) EQ.1: rock/concrete
SECP	Shear enhanced compaction
AFIT	Ductile damage mechanics parameter (=1 no damage)
BFIT	Ductile damage mechanics parameter (=0 no damage)
RDAM0	Ductile damage mechanics parameter
W	Plastic Volume Strain parameter, W
D1	Plastic Volume Strain parameter, $D_1$
D2	Plastic Volume Strain parameter, $D_2$ $\varepsilon_V^p = W \left( 1 - \exp \left[ -D_1 (X(\kappa) - X(\kappa_0)) - D_2 (X(\kappa) - X(\kappa_0))^2 \right] \right)$
NPLOT	History variable post-processed as effective plastic strain (See Table 145.1 for history variables available for plotting)
EPSMAX	Maximum permitted strain increment (default = 0) $\Delta \varepsilon_{\max} = 0.05(\alpha - N^\alpha - \gamma) \min \left( \frac{1}{G}, \frac{R}{9K} \right)$ (calculated default)
CFIT	Brittle damage mechanics parameter (=1 no damage)
DFIT	Brittle damage mechanics parameter (=0 no damage)
TFAIL	Tensile failure stress

VARIABLE	DESCRIPTION
FAILFL	Flag controlling element deletion and effect of damage on stress (see Remarks 1 and 2): EQ.1: $\sigma_{ij}$ reduces with increasing damage; element is deleted when fully damaged (default) EQ.-1: $\sigma_{ij}$ reduces with increasing damage; element is not deleted EQ.2: $S_{ij}$ reduces with increasing damage; element is deleted when fully damaged EQ.-2: $S_{ij}$ reduces with increasing damage; element is not deleted
DBETA	Rounded vertices parameter, $\Delta\beta_0$
DDELTA	Rounded vertices parameter, $\delta$
VPTAU	Viscoplasticity relaxation time parameter, $\tau$
ALPHA1	Torsion scaling parameter, $\alpha_1$ $\alpha_1 < 0 \rightarrow  \alpha_1  =$ Friction Angle (degrees)
THETA1	Torsion scaling parameter, $\theta_1$
GAMMA1	Torsion scaling parameter, $\gamma_1$
BETA1	Torsion scaling parameter, $\beta_1$ $Q_1 = \alpha_1 - \gamma_1 \exp(-\beta_1 J_1) + \theta_1 J_1$
ALPHA2	Tri-axial extension scaling parameter, $\alpha_2$
THETA2	Tri-axial extension scaling parameter, $\theta_2$
GAMMA2	Tri-axial extension scaling parameter, $\gamma_2$
BETA2	Tri-axial extension scaling parameter, $\beta_2$ $Q_2 = \alpha_2 - \gamma_2 \exp(-\beta_2 J_1) + \theta_2 J_1$

**Remarks:**

1. FAILFL controls whether the damage accumulation applies to either the total stress tensor  $\sigma_{ij}$  or the deviatoric stress tensor  $S_{ij}$ . When FAILFL = 2, damage does not diminish the ability of the material to support hydrostatic stress.
2. FAILFL also serves as a flag to control element deletion. Fully damaged elements are deleted only if FAILFL is a positive value. When MAT\_145 is used with the ALE or

EFG solvers, failed elements should not be eroded and so a negative value of FAILFL should be used.

### Output History Variables

All the output parameters listed in Table 145.1 is available for post-processing using LS-PrePost and its displayed list of History Variables. The LS-DYNA input parameter NEIPH should be set to 26; see for example the keyword input for \*DATABASE\_EXTENT\_BINARY.

PLOT	Function	Description
1	$X(\kappa)$	$J_1$ intercept of cap surface
2	$L(\kappa)$	$J_1$ value at cap-shear surface intercept
3	$R$	Cap surface ellipticity
4	$\tilde{R}$	Rubin function
5	$\varepsilon_v^p$	Plastic volume strain
6		Yield Flag (= 0 elastic)
7		Number of strain sub-increments
8	$G^\alpha$	Kinematic hardening parameter
9	$J_2^\alpha$	Kinematic hardening back stress
10		Effective strain rate
11		Ductile damage
12		Ductile damage threshold
13		Strain energy
14		Brittle damage
15		Brittle damage threshold
16		Brittle energy norm
17		$J_1$ (w/o visco-damage/plastic)
18		$J_2'$ (w/o visco-damage/plastic)
19		$J_3'$ (w/o visco-damage/plastic)
20		$\hat{J}_3$ (w/o visco-damage/plastic)
21	$\beta$	Lode Angle
22	d	Maximum damage parameter
23		future variable
24		future variable
25		future variable
26		future variable

**Table 145.1.** Output variables for post-processing using NPLOT parameter.

**Sample Input for Concrete**

Gran and Senseny [1996] report the axial stress versus strain response for twelve unconfined compression tests of concrete, used in scale-model reinforced-concrete wall tests. The Schwer & Murray Cap Model parameters provided below were used, see Schwer [2001], to model the unconfined compression test stress-strain response for the nominal 40 MPa strength concrete reported by Gran and Senseny. The basic units for the provided parameters are length in millimeters (mm), time in milliseconds (msec), and mass in grams (g). This base unit set yields units of force in Newtons (N) and pressure in Mega-Pascals (MPa).

Keyword:

Card 1	1	2	3	4	5	6	7	8
Variable	MID	RO	SHEAR	BULK	GRUN	SHOCK	PORE	
Type	A8	2.3E-3	1.048E4	1.168E4	0.0	0.0	1.	

Card 2	1	2	3	4	5	6	7	8
Variable	ALPHA	THETA	GAMMA	BETA	EFIT	FFIT	ALPHAN	CALPHA
Type	190.0	0.0	184.2	2.5E-3	0.999	0.7	2.5	2.5E3

Card 3	1	2	3	4	5	6	7	8
Variable	R0	X0	IROCK	SECP	AFIT	BFIT	RDAM0	
Type	5.0	100.0	1.0	0.0	0.999	0.3	0.94	

Card 4	1	2	3	4	5	6	7	8
Variable	W	D1	D2	NPLOT	EPSMAX	CFIT	DFIT	TFAIL
Type	5.0E-2	2.5E-4	3.5E-7	23.0	0.0	1.0	300.0	7.0

Card 5	1	2	3	4	5	6	7	8
Variable	FAILFG	DBETA	DDELTA	VPTAU				
Type	1.0	0.0	0.0	0.0				

Card 6	1	2	3	4	5	6	7	8
Variable	ALPHA1	THETA1	GAMMA 1	BETA1	ALPHA2	THETA2	GAMMA 2	BETA2
Type	0.747	3.3E-4	0.17	5.0E-2	0.66	4.0E-4	0.16	5.0E-2

**User Input Parameters and System of Units**

Consider the following basic units:

- Length -  $L$  (e.g. millimeters - mm )
- Mass -  $M$  (e.g. grams - g )
- Time -  $T$  (e.g. milliseconds - ms )

The following consistent unit systems can then be derived using Newton's Law, i.e.  $F = Ma$ .

- Force -  $F = ML / T^2$  [ g-mm/ms<sup>2</sup> = Kg-m/s<sup>2</sup> = Newton - N ]
- and
- Stress -  $\sigma = F / L^2$  [ N/mm<sup>2</sup> = 10<sup>6</sup> N/m<sup>2</sup> = 10<sup>6</sup> Pascals = MPa ]
- and
- Density -  $\rho = M / L^3$  [ g/mm<sup>3</sup> = 10<sup>6</sup> Kg/m<sup>3</sup> ]

User Inputs and Units:

Card 1	1	2	3	4	5	6	7	8
Variable	MID	RO	SHEAR	BULK	GRUN	SHOCK	PORE	
Units	I	Density M/L <sup>3</sup>	Stress F/L <sup>2</sup>	Stress F/L <sup>2</sup>				

Card 2            1            2            3            4            5            6            7            8

Variable	ALPHA	THETA	GAMMA	BETA	EFIT	FFIT	ALPHAN	CALPHA
Units	Stress F/L <sup>2</sup>		Stress F/L <sup>2</sup>	$\left(\frac{\text{Stress}}{F/L^2}\right)^{-1}$		$\left(\frac{\text{Stress}}{F/L^2}\right)^{-1/2}$	Stress F/L <sup>2</sup>	Stress F/L <sup>2</sup>

Card 3            1            2            3            4            5            6            7            8

Variable	R0	X0	IROCK	SECP	AFIT	BFIT	RDAM0	
Units		Stress F/L <sup>2</sup>				$\left(\frac{\text{Stress}}{F/L^2}\right)^{-1/2}$	$\left(\frac{\text{Stress}}{F/L^2}\right)^{1/2}$	

Card 4            1            2            3            4            5            6            7            8

Variable	W	D1	D2	NPLOT	MAXEPS	CFIT	DFIT	TFAIL
Units		$\left(\frac{\text{Stress}}{F/L^2}\right)^{-1}$	$\left(\frac{\text{Stress}}{F/L^2}\right)^{-2}$				$\left(\frac{\text{Stress}}{F/L^2}\right)^{-1/2}$	Stress F/L <sup>2</sup>

Card 5            1            2            3            4            5            6            7            8

Variable	FAILFG	DBETA	DDELTA	VPTAU				
Units		Angle degrees		Time T				

Card 6            1            2            3            4            5            6            7

Variable	ALPHA1	THETA1	GAMMA1	BETA1	ALPHA2	THETA2	GAMMA2	BETA2
Units	Stress F/L <sup>2</sup>		Stress F/L <sup>2</sup>	$\left(\frac{\text{Stress}}{F/L^2}\right)^{-1}$	Stress F/L <sup>2</sup>		Stress F/L <sup>2</sup>	$\left(\frac{\text{Stress}}{F/L^2}\right)^{-1}$

Card 6            1            2            3            4            5            6            7            8

Variable	ALPHA1	THETA1	GAMMA1	BETA1	ALPHA2	THETA2	GAMMA2	BETA2
Units	Stress F/L <sup>2</sup>		Stress F/L <sup>2</sup>	$\left(\frac{\text{Stress}}{F/L^2}\right)^{-1}$	Stress F/L <sup>2</sup>		Stress F/L <sup>2</sup>	$\left(\frac{\text{Stress}}{F/L^2}\right)^{-1}$

**\*MAT\_1DOF\_GENERALIZED\_SPRING**

This is Material Type 146. This is a linear spring or damper that allows different degrees-of-freedom at two nodes to be coupled.

Card 1            1            2            3            4            5            6            7            8

Variable	MID	RO	K	C	SCLN1	SCLN2	DOFN1	DOFN2
Type	A8	F	F	F	F	F	I	I

Card 2            1            2            3            4            5            6            7            8

Variable	CID1	CID2						
Type	I	I						

<u>VARIABLE</u>	<u>DESCRIPTION</u>
MID	Material identification. A unique number or label not exceeding 8 characters must be specified.
RO	Mass density, see also volume in *SECTION_BEAM definition.
K	Spring stiffness.
C	Damping constant.
SCLN1	Scale factor on force at node 1. Default=1.0.
SCLN2	Scale factor on force at node 2. Default=1.0.
DOFN1	Active degree-of-freedom at node 1, a number between 1 to 6 where 1 is x-translation and 4 is x-rotation. If this parameter is defined in the SECTION_BEAM definition or on the ELEMENT_BEAM_SCALAR card, then the value here, if defined, is ignored.
DOFN2	Active degree-of-freedom at node 2, a number between 1 to 6. If this parameter is defined in the SECTION_BEAM definition or on the ELEMENT_BEAM_SCALAR card, then the value here, if defined, is ignored.



---

<u>VARIABLE</u>	<u>DESCRIPTION</u>
CID1	Local coordinate system at node 1. This coordinate system can be overwritten by a local system specified on the *ELEMENT_BEAM_SCALAR or *SECTION_BEAM keyword input. If no coordinate system is specified, the global system is used.
CID2	Local coordinate system at node 2. If CID2=0, CID2=CID1.

**\*MAT\_FHWA\_SOIL**

This is Material Type 147. This is an isotropic material with damage and is available for solid elements. The model has a modified Mohr-Coulomb surface to determine the pressure dependent peak shear strength. It was developed for applications involving roadbase soils by Lewis [1999] for the FHWA, who extended the work of Abbo and Sloan [1995] to include excess pore water effects.

Card 1            1            2            3            4            5            6            7            8

Variable	MID	RO	NPLOT	SPGRAV	RHOWAT	VN	GAMMAR	INTRMX
Type	A8	F	I	F	F	F	F	I
Default	none	none	1	none	1.0	0.0	0.0	1

Card 2            1            2            3            4            5            6            7            8

Variable	K	G	PHIMAX	AHYP	COH	ECCEN	AN	ET
Type	F	F	F	F	F	F		
Default	none	none	none	none	none	none	none	none

Card 3            1            2            3            4            5            6            7            8

Variable	MCONT	PWD1	PWKSK	PWD2	PHIRES	DINT	VDFM	DAMLEV
Type	F	F	F	F	F	F	F	F
Default	none	none	none	none	0.0	none	none	none

Card 4            1            2            3            4            5            6            7            8

Variable	EPSMAX								
Type	F								
Default	none								

<u>VARIABLE</u>	<u>DESCRIPTION</u>
MID	Material identification. A unique number or label not exceeding 8 characters must be specified.
RO	Mass density
NPLOT	Controls what is written as component 7 to the d3plot database. LS-PrePost always blindly labels this component as effective plastic strain. EQ.1: Effective Strain EQ.2: Damage Criterion Threshold EQ.3: Damage (diso) EQ.4: Current Damage Criterion EQ.5: Pore Water Pressure EQ.6: Current Friction Angle (phi)
SPGRAV	Specific Gravity of Soil used to get porosity.
RHOWATt	Density of water in model units - used to determine air void strain (saturation)
VN	Viscoplasticity parameter (strain-rate enhanced strength)
GAMMAr	Viscoplasticity parameter (strain-rate enhanced strength)
ITERMAXx	Maximum number of plasticity iterations (default 1)
K	Bulk Modulus (non-zero)
G	Shear modulus (non-zero)
PHIMAX	Peak Shear Strength Angle (friction angle) (radians)
AHYP	Coefficient A for modified Drucker-Prager Surface
COH	Cohesion ñ Shear Strength at zero confinement (overburden)

<b>VARIABLE</b>	<b>DESCRIPTION</b>
ECCEN	Eccentricity parameter for third invariant effects
AN	Strain hardening percent of phi max where non-linear effects start
ET	Strain Hardening Amount of non-linear effects
MCONT	Moisture Content of Soil (Determines amount of air voids) (0-1.00)
PWD1	Parameter for pore water effects on bulk modulus
PWKSK	Skeleton bulk modulus- Pore water parameter $n$ set to zero to eliminate effects
PWD2	Parameter for pore water effects on the effective pressure (confinement)
PHIRES	The minimum internal friction angle, radians (residual shear strength)
DINT	Volumetric Strain at Initial damage threshold, EMBED Equation.3
VDFM	Void formation energy (like fracture energy)
DAMLEV	Level of damage that will cause element deletion (0.0-1.0)
EPSMAX	Maximum principle failure strain

**\*MAT\_FHWA\_SOIL\_NEBRASKA**

This is an option to use the default properties determined for soils used at the University of Nebraska (Lincoln). The default units used for this material are millimeter, millisecond, and kilograms. If different units are desired, the conversion factors must be input.

This is Material Type 147. This is an isotropic material with damage and is available for solid elements. The model has a modified Mohr-Coulomb surface to determine the pressure dependent peak shear strength. It was developed for applications involving road base soils.

Card 1            1            2            3            4            5            6            7            8

Variable	MID	FCTIM	FCTMAS	FCTLEN				
Type	A8	F	I	F	F	F	F	I
Default	none	none	1	none	1.0	0.0	0.0	1

<u>VARIABLE</u>	<u>DESCRIPTION</u>
MID	Material identification. A unique number or label not exceeding 8 characters must be specified.
FCTIM	Factor to multiply milliseconds by to get desired time units
FCTMAS	Factor to multiply kilograms by to get desired mass units
FCTLEN	Factor to multiply millimeters by to get desired length units

**\*MAT\_GAS\_MIXTURE**

This is Material Type 148. This model is for the simulation of thermally equilibrated ideal gas mixtures. This only works with the multi-material ALE formulation (ELFORM=11 in \*SECTION\_SOLID). This keyword needs to be used together with \*INITIAL\_GAS\_MIXTURE for the initialization of gas densities and temperatures. When applied in the context of ALE airbag modeling, the injection of inflator gas is done with a \*SECTION\_POINT\_SOURCE\_MIXTURE command which controls the injection process. This material model type also has its name start with \*MAT\_ALE\_. For example, an identical material model to this is \*MAT\_ALE\_GAS\_MIXTURE (or also, \*MAT\_ALE\_03).

Card 1            1            2            3            4            5            6            7            8

Variable	MID	IADIAB	RUNIV					
Type	A8	I	F					
Default	none	0	0.0					
Remark		5	1					

**Card 2: Method (A) RUNIV=BLANK or 0.0 → Per-mass unit is used**

Card 2            1            2            3            4            5            6            7            8

Variable	CVmass1	CVmass2	CVmass3	CVmass4	CVmass5	CVmass6	CVmass7	CVmass8
Type	F	F	F	F	F	F	F	F
Default	none	none	none	none	none	none	none	none
Remark								

**Card 3: Method (A) RUNIV=BLANK or 0.0 → Per-mass unit is used**

Card 3            1            2            3            4            5            6            7            8

Variable	CPmass1	CPmass 2	CPmass 3	CPmass 4	CPmass 5	CPmass6	CPmass 7	CPmass 8
Type	F	F	F	F	F	F	F	F
Default	none	none	none	none	none	none	none	none
Remark								

**Card 2: Method (B) RUNIV is nonzero**

Card 2            1            2            3            4            5            6            7            8

Variable	MOLWT1	MOLWT2	MOLWT3	MOLWT4	MOLWT5	MOLWT6	MOLWT7	MOLWT8
Type	F	F	F	F	F	F	F	F
Default	none	none	none	none	none	none	none	none
Remark	2							

**Card 3: Method (B) RUNIV is nonzero → Per-mole unit is used**

Card 3            1            2            3            4            5            6            7            8

Variable	CPmole1	CPmole2	CPmole3	CPmole4	CPmole5	CPmole6	CPmole7	CPmole8
Type	F	F	F	F	F	F	F	F
Default	none	none	none	none	none	none	none	none
Remark	2							

**Card 4: Method (B) RUNIV is nonzero**

Card 4            1            2            3            4            5            6            7            8

Variable	B1	B2	B3	B4	B5	B6	B7	B8
Type	F	F	F	F	F	F	F	F
Default	none	none	none	none	none	none	none	none
Remark	2							

**Card 5: Method (B) RUNIV is nonzero**

Card 5            1            2            3            4            5            6            7            8

Variable	C1	C2	C3	C4	C5	C6	C7	C8
Type	F	F	F	F	F	F	F	F
Default	none	none	none	none	none	none	none	none
Remark	2							

<u>VARIABLE</u>	<u>DESCRIPTION</u>
MID	Material identification. A unique number or label not exceeding 8 characters must be specified.
IADIAB	This flag (default=0) is used to turn ON/OFF adiabatic compression logics for an ideal gas (remark 5). EQ.0: OFF (default) EQ.1: ON
RUNIV	Universal gas constant in per-mole unit (8.31447 J/(mole*K)).
CVmass1- CVmass8	If RUNIV is BLANK or zero (method A): Heat capacity at constant volume for up to eight different gases in per-mass unit.
CPmass1- CPmass8	If RUNIV is BLANK or zero (method A): Heat capacity at constant pressure for up to eight different gases in per-mass unit.



VARIABLE	DESCRIPTION
MOLWT1- MOLWT8	If RUNIV is nonzero (method B): Molecular weight of each ideal gas in the mixture (mass-unit/mole).
CPmole1- CPmole8	If RUNIV is nonzero (method B): Heat capacity at constant pressure for up to eight different gases in per-mole unit. These are nominal heat capacity values typically at STP. These are denoted by the variable "A" in the equation in remark 2.
B1-B8	If RUNIV is nonzero (method B): First order coefficient for a temperature dependent heat capacity at constant pressure for up to eight different gases. These are denoted by the variable "B" in the equation in remark 2.
C1-C8	If RUNIV is nonzero (method B): Second order coefficient for a temperature dependent heat capacity at constant pressure for up to eight different gases. These are denoted by the variable "C" in the equation in remark 2.

### Remarks:

- There are 2 methods of defining the gas properties for the mixture. If RUNIV is BLANK or ZERO → Method (A) is used to define constant heat capacities where per-mass unit values of  $C_v$  and  $C_p$  are input. Only cards 2 and 3 are required for this method. Method (B) is used to define constant or temperature dependent heat capacities where per-mole unit values of  $C_p$  are input. Cards 2-5 are required for this method.

- The per-mass-unit, temperature-dependent, constant-pressure heat capacity is

$$C_p(T) = \frac{[A + B * T + C * T^2]}{MW} \sim \frac{J}{kg * K} \quad B \sim J / (mole * K^2)$$

$$A = \tilde{C}_{p0} \sim J / (mole * K) \quad C \sim J / (mole * K^3)$$

The units shown are only for demonstration of the equation.

- The initial temperature and the density of the gas species present in a mesh or part at time zero is specified by the keyword \*INITIAL\_GAS\_MIXTURE.
- The ideal gas mixture is assumed to be thermal equilibrium, that is, all species are at the same temperature (T). The gases in the mixture are also assumed to follow Dalton's Partial Pressure Law,  $P = \sum_i^{ngas} P_i$ . The partial pressure of each gas is then  $P_i = \rho_i R_{gas_i} T$

where  $R_{gasi} = \frac{R_{univ}}{MW}$ . The individual gas species temperature equals the mixture

temperature. The temperature is computed from the internal energy where the *mixture internal energy per unit volume* is used,

$$e_v = \sum_i^{ngas} \rho_i C_{V_i} T_i = \sum_i^{ngas} \rho_i C_{V_i} T$$

$$T = T_i = \frac{e_v}{\sum_i^{ngas} \rho_i C_{V_i}}$$

In general, the advection step conserves momentum and internal energy, but not kinetic energy. This can result in energy lost in the system and lead to a pressure drop. In \*MAT\_GAS\_MIXTURE the dissipated kinetic energy is automatically converted into heat (internal energy). Thus in effect the total energy is conserved instead of conserving just the internal energy. This numerical scheme has been shown to improve accuracy in some cases. However, the user should always be vigilant and check the physics of the problem closely.

- As an example consider an airbag surrounded by ambient air. As the inflator gas flows into the bag, the ALE elements cut by the airbag fabric shell elements will contain some inflator gas inside and some ambient air outside. The multi-material element treatment is not perfect. Consequently the temperature of the outside air may be made artificially high after the multi-material element treatment. To prevent the outside ambient air from getting artificially high T, set IDIAB=1 for the ambient air outside. Simple adiabatic compression equation is then assumed for the outside air. The use of this flag may be needed, but only when that air is modeled by the \*MAT\_GAS\_MIXTURE card.

**Example:**

Consider a tank test model where the Lagrangian tank (Part S1) is surrounded by an ALE air mesh (Part H4=AMMGID 1). There are 2 ALE parts which are defined but initially have no corresponding mesh: part 5 (H5=AMMGID 2) is the resident gas inside the tank at t = 0, and part 6 (H6=AMMGID 2) is the inflator gas(es) which is injected into the tank when t > 0. AMMGID stands for ALE Multi-Material Group ID. Please see figure and input below. The \*MAT\_GAS\_MIXTURE (MGM) card defines the gas properties of ALE parts H5 & H6. The MGM card input for both method (A) and (B) are shown.

The \*INITIAL\_GAS\_MIXTURE card is also shown. It basically specifies that “AMMGID 2 may be present in part or mesh H4 at t=0, and the initial density of this gas is defined in the rho1 position which corresponds to the 1<sup>st</sup> material in the mixture (or H5, the resident gas).”

**Example configuration:**

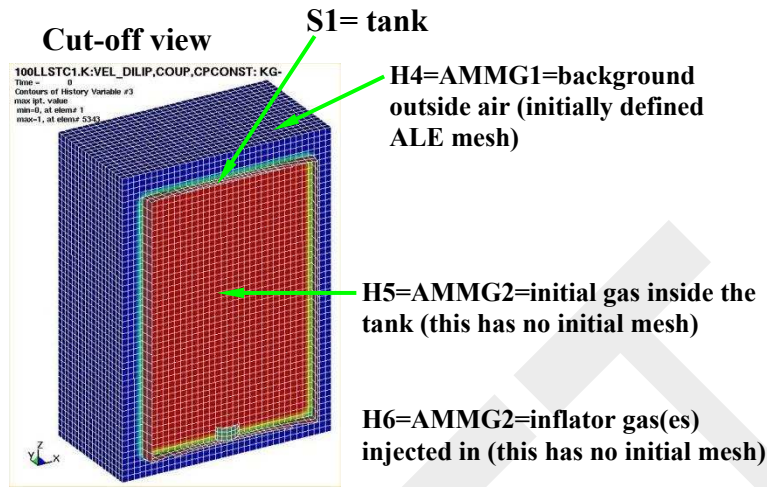

**Sample input:**

```

$-----
*PART
H5 = initial gas inside the tank
$      PID      SECID      MID      EOSID      HGID      GRAV      ADOPT      TMID
$          5          5          5          0          5          0          0
*SECTION_SOLID
$          5          11          0
$-----
$ Example 1: Constant heat capacities using per-mass unit.
$*MAT_GAS_MIXTURE
$      MID      IADIAB      R_univ
$          5          0          0
$      Cv1_mas  Cv2_mas  Cv3_mas  Cv4_mas  Cv5_mas  Cv6_mas  Cv7_mas  Cv8_mas
$718.7828911237.56228
$      Cp1_mas  Cp2_mas  Cp3_mas  Cp4_mas  Cp5_mas  Cp6_mas  Cp7_mas  Cp8_mas
$1007.00058 1606.1117
$-----
$ Example 2: Variable heat capacities using per-mole unit.
$*MAT_GAS_MIXTURE
$      MID      IADIAB      R_univ
$          5          0      8.314470
$      MW1      MW2      MW3      MW4      MW5      MW6      MW7      MW8
$ 0.0288479 0.02256
$      Cp1_mol  Cp2_mol  Cp3_mol  Cp4_mol  Cp5_mol  Cp6_mol  Cp7_mol  Cp8_mol
$29.049852 36.23388
$      B1      B2      B3      B4      B5      B6      B7      B8
$ 7.056E-3 0.132E-1
$      C1      C2      C3      C4      C5      C6      C7      C8
$ -1.225E-6 -0.190E-5
$-----
$ One card is defined for each AMMG that will occupy some elements of a mesh set
$*INITIAL_GAS_MIXTURE
$      SID      STYPE      MMGID      T0
$          4          1          1          298.15
$      RHO1      RHO2      RHO3      RHO4      RHO5      RHO6      RHO7      RHO8
$ 1.17913E-9
$*INITIAL_GAS_MIXTURE
$      SID      STYPE      MMGID      T0
$          4          1          2          298.15
$      RHO1      RHO2      RHO3      RHO4      RHO5      RHO6      RHO7      RHO8
$ 1.17913E-9
$-----

```

**\*MAT\_EMMI**

This is Material Type 151. The Evolving Microstructural Model of Inelasticity (EMMI) is a temperature and rate-dependent state variable model developed to represent the large deformation of metals under diverse loading conditions [Marin 2005]. This model is available for 3D solid elements, 2D solid elements and thick shell forms 3 and 5 .

Card 1            1            2            3            4            5            6            7            8

Variable	MID	RHO	E	PR				
Type	A8	F	F	F				

Card 2            1            2            3            4            5            6            7            8

Variable	RGAS	BVECT	D0	QD	CV	ADRAG	BDRAG	DMTHETA
Type	F	F	F	F	F	F	F	F

Card 3            1            2            3            4            5            6            7            8

Variable	DMPHI	DNTHETA	DNPHI	THETA0	THETAM	BETA0	BTHETA	DMR
Type	F	F	F	F	F	F	F	F

Card 4            1            2            3            4            5            6            7            8

Variable	DNUC1	DNUC2	DNUC3	DNUC4	DM1	DM2	DM3	DM4
Type	F	F	F	F	F	F	F	F

Card 5            1            2            3            4            5            6            7            8

Variable	DM5	Q1ND	Q2ND	Q3ND	Q4ND	CALPHA	CKAPPA	C1
Type	F	F	F	F	F	F	F	F

Card 6            1            2            3            4            5            6            7            8

Variable	C2ND	C3	C4	C5	C6	C7ND	C8ND	C9ND
Type	F	F	F	F	F	F	F	F

Card 7            1            2            3            4            5            6            7            8

Variable	C10	A1	A2	A3	A4	A_XX	A_YY	A_ZZ
Type	F	F	F	F	F	F	F	F

Card 8            1            2            3            4            5            6            7            8

Variable	A_XY	A_YZ	A_XZ	ALPHXX	ALPHYY	ALPHZZ	ALPHXY	ALPHYZ
Type	F	F	F	F	F	F	F	F

Card 9            1            2            3            4            5            6            7            8

Variable	ALPHXZ	DKAPPA	PHI0	PHICR	DLBDAG	FACTOR	RSWTCH	DMGOPT
Type	F	F	F	F	F	F	F	F

Card 10            1            2            3            4            5            6            7            8

Variable	DELASO	DIMPLO	ATOL	RTOL	DINTER			
Type	F	F	F	F	F			

Card 11    Leave blank

Variable								
Type								

<u>VARIABLE</u>	<u>DESCRIPTION</u>
MID	Material identification. A unique number or label not exceeding 8 characters must be specified.
RHO	Material density.
E	Young's modulus
PR	Poisson's ratio
RGAS	universal gas constant.
BVECT	Burger's vector
D0	pre-exponential diffusivity coefficient
QD	activation energy
CV	specific heat at constant volume
ADRAG	drag intercept
BDRAG	drag coefficient
DMTHETA	shear modulus temperature coefficient
DMPHI	shear modulus damage coefficient
DNTHETA	bulk modulus temperature coefficient

<u>VARIABLE</u>	<u>DESCRIPTION</u>
DNPFI	bulk modulus damage coefficient
THETA0	reference temperature
THETAM	melt temperature
BETA0	coefficient of thermal expansion at reference temperature
BTHETA	thermal expansion temperature coefficient
DMR	damage rate sensitivity parameter
DNUC1	nucleation coefficient 1
DNUC2	nucleation coefficient 2
DNUC3	nucleation coefficient 3
DNUC4	nucleation coefficient 4
DM1	coefficient of yield temperature dependence
DM2	coefficient of yield temperature dependence
DM3	coefficient of yield temperature dependence
DM4	coefficient of yield temperature dependence
DM5	coefficient of yield temperature dependence
Q1ND	dimensionless activation energy for f
Q2ND	dimensionless activation energy for rd
Q3ND	dimensionless activation energy for Rd
Q4ND	dimensionless activation energy Rs
CALPHA	coefficient for backstress alpha
CKAPPA	coefficient for internal stress kappa
C1	parameter for flow rule exponent n
C2ND	parameter for transition rate f
C3	parameter for alpha dynamic recovery rd

<b>VARIABLE</b>	<b>DESCRIPTION</b>
C4	parameter for alpha hardening h
C5	parameter for kappa dynamic recovery Rd
C6	parameter for kappa hardening H
C7ND	parameter kappa static recovery Rs
C8ND	parameter for yield
C9ND	parameter for temperature dependence of flow rule exponent n
C10	parameter for static recovery (set=1)
A1	plastic anisotropy parameter
A2	plastic anisotropy parameter
A3	plastic anisotropy parameter
A4	plastic anisotropy parameter
A_XX	initial structure tensor component
A_YY	initial structure tensor component
A_ZZ	initial structure tensor component
A_XY	initial structure tensor component
A_YZ	initial structure tensor component
A_XZ	initial structure tensor component
ALPHXX	initial backstress component
ALPHYY	initial backstress component
ALPHZZ	initial backstress component
ALPHXY	initial backstress component
ALPHYZ	initial backstress component
ALPHXZ	initial backstress component
DKAPPA	initial isotropic internal stress



VARIABLE	DESCRIPTION
PHI0	initial isotropic porosity
PHICR	critical cutoff porosity
DLBDAG	slip system geometry parameter
FACTOR	fraction of plastic work converted to heat, adiabatic
RSWTCH	rate sensitivity switch
DMGOPT	Damage model option parameter EQ.1.0: pressure independent Cocks/Ashby 1980 EQ.2.0: pressure dependent Cocks/Ashby 1980 EQ.3.0: pressure dependent Cocks 1989
DELASO	Temperature option EQ.0.0: driven externally EQ.1.0: adiabatic
DIMPLO	Implementation option flag EQ.1.0: combined viscous drag and thermally activated dislocation motion EQ.2.0: separate viscous drag and thermally activated dislocation motion
ATOL	absolute error tolerance for local Newton iteration
RTOL	relative error tolerance for local Newton iteration
DNITER	maximum number of iterations for local Newton iteration

**Remarks:**

$$\overset{\nabla}{\boldsymbol{\alpha}} = h \mathbf{d}^p - r_d \dot{\boldsymbol{\varepsilon}}^p \bar{\alpha} \boldsymbol{\alpha}$$

$$\dot{\kappa} = (H - R_d \kappa) \dot{\boldsymbol{\varepsilon}}^p - R_s \kappa \sinh(Q_s \kappa)$$

$$\mathbf{d}^p = \sqrt{\frac{3}{2}} \dot{\boldsymbol{\varepsilon}}^p \mathbf{n}, \quad \dot{\boldsymbol{\varepsilon}}^p = f \sinh^n \left[ \left\langle \frac{\bar{\sigma}}{\kappa + Y} - 1 \right\rangle \right]$$

$\dot{\epsilon}^p$ - equation	$\alpha$ - equation	$\kappa$ - equation
$f = c_2 \exp\left(\frac{Q_1}{\theta}\right)$	$r_d = c_3 \exp\left(\frac{-Q_2}{\theta}\right)$	$R_d = c_5 \exp\left(\frac{-Q_3}{\theta}\right)$
$n = \frac{c_9}{\theta} - c_1$	$h = c_4 \mu(\theta)$	$H = c_6 \mu(\theta)$
$Y = c_8 Y(\theta)$		$R_s = c_7 \exp\left(\frac{-Q_4}{\theta}\right)$
		$Q_s = c_{10} \exp\left(\frac{-Q_5}{\theta}\right)$

**Table 151.1.** Plasticity Material Functions of EMMI Model.

Void growth:

$$\dot{\phi} = \frac{3}{\sqrt{2}} (1 - \phi) G(\bar{\sigma}_{eq}, \bar{p}, \phi) \dot{\epsilon}^p$$

$$G(\bar{\sigma}_{eq}, \bar{p}, \phi) = \frac{3}{\sqrt{3}} \left[ \frac{1}{(1 - \phi)m + 1} - 1 \right] \sinh \left[ \frac{2(2m - 1) \langle \bar{p} \rangle}{2m + 1 \bar{\sigma}_{eq}} \right]$$

## \*MAT\_DAMAGE\_3

This is Material Type 153. This model has two back stress terms for kinematic hardening combined with isotropic hardening and a damage model for modeling low cycle fatigue and failure. Huang [2006] programmed this model and provided it as a user subroutine with the documentation that follows. It is available for beam, shell and solid elements. This material model is available starting with the R3 release of Version 971.

Card 1            1            2            3            4            5            6            7            8

Variable	MID	RO	E	PR	SIGY	HARDI	BETA	LCSS
Type	A8	F	F	F	F	F	F	I

Card 2            1            2            3            4            5            6            7            8

Variable	HARDK1	GAMMA1	HARDK2	GAMMA2	SRC	SRP		
Type	F	F	F	F	F	F		

Card 3            1            2            3            4            5            6            7            8

Variable	IDAMAGE	IDS	IDEP	EPSD	S	T	DC	
Type	I	I	I	F	F	F	F	

**VARIABLE****DESCRIPTION**

MID	Material identification. A unique number or label not exceeding 8 characters must be specified.
RO	Mass density, $\rho$
E	Young's modulus, $E$
PR	Poisson's ratio, $\nu$
SIGY	Initial yield stress, $\sigma_{y,0}$ (ignored if LCSS.GT.0)

VARIABLE	DESCRIPTION
HARDI	Isotropic hardening modulus, $H$ (ignored if LCSS.GT.0)
BETA	Isotropic hardening parameter, $\beta$ . Set $\beta = 0$ for linear isotropic hardening. (Ignored if LCSS.GT.0 or if HARDI.EQ.0.)
LCSS	Load curve ID defining effective stress vs. effective plastic strain for isotropic hardening. The first abscissa value must be zero corresponding to the initial yield stress. The first ordinate value is the initial yield stress.
HARDK1	Kinematic hardening modulus $C_1$
GAMMA1	Kinematic hardening parameter $\gamma_1$ . Set $\gamma_1 = 0$ for linear kinematic hardening. Ignored if (HARDK1.EQ.0) is defined.
HARDK2	Kinematic hardening modulus $C_2$
GAMMA2	Kinematic hardening parameter $\gamma_2$ . Set $\gamma_2 = 0$ for linear kinematic hardening. Ignored if (HARDK2.EQ.0) is defined.
SRC	Strain rate parameter, $C$ , for Cowper Symonds strain rate model, see below. If zero, rate effects are not considered.
SRP	Strain rate parameter, $P$ , for Cowper Symonds strain rate model, see below. If zero, rate effects are not considered.
IDAMAGE	Isotropic damage flag EQ. 0: damage is inactivated. IDS, IDEP, EPSD, S, T, DC are ignored. EQ. 1: damage is activated
IDS	Output stress flag EQ. 0: undamaged stress is $\tilde{\sigma}$ output EQ. 1: damaged stress is $\tilde{\sigma}(1-D)$ output
IDEP	Damaged plastic strain EQ. 0: plastic strain is accumulated $r = \int \dot{\epsilon}^{pl}$ EQ. 1: damaged plastic strain is accumulated $r = \int (1-D) \dot{\epsilon}^{pl}$
EPSD	Damage threshold $r_d$ . Damage accumulation begins when $r > r_d$
S	Damage material constant $S$ . Default = $\sigma_{y0}/200$

VARIABLE	DESCRIPTION
T	Damage material constant $t$ . Default = 1
DC	Critical damage value $D_c$ . When damage value reaches critical, the element is deleted from calculation. Default = 0.5

**Remarks:**

This model is based on the work of Lemaitre [1992], and Dufailly and Lemaitre [1995]. It is a pressure-independent plasticity model with the yield surface defined by the function

$$F = \bar{\sigma} - \sigma_y = 0$$

where  $\sigma_y$  is uniaxial yield stress

$$\sigma_y = \sigma_{y0} + \frac{H}{\beta} [1 - \exp(-\beta r)]$$

By setting  $\beta = 0$ , a linear isotropic hardening is obtained

$$\sigma_y = \sigma_{y0} + Hr$$

where  $\sigma_{y0}$  is the initial yield stress. And  $\bar{\sigma}$  is the equivalent von Mises stress, with respect to the deviatoric effective stress

$$s_e = dev[\tilde{\sigma}] - \alpha = s - \alpha$$

where  $s$  is deviatoric stress and  $\alpha$  is the back stress, which is decomposed into several components

$$\alpha = \sum_j \alpha_j$$

and  $\tilde{\sigma}$  is effective stress (undamaged stress), based on Continuum Damage Mechanics model [Lemaitre 1992]

$$\tilde{\sigma} = \frac{\sigma}{1-D}$$

where  $D$  is the isotropic damage scalar, which is bounded by 0 and 1

$$0 \leq D \leq 1$$

$D = 0$  represents a damage-free material RVE (representative Volume Element), while  $D = 1$  represents a fully broken material RVE in two parts. In fact, fracture occurs when  $D = D_c < 1$ ,

modeled as element removal. The evolution of the isotropic damage value related to ductile damage and fracture (the case where the plastic strain or dissipation is much larger than the elastic one, [Lemaitre 1992]) is defined as

$$\dot{D} = \begin{cases} \left(\frac{Y}{S}\right)^t \dot{\varepsilon}^{pl} & r > r_d \ \& \ \frac{\sigma_m}{\sigma_{eq}} > -\frac{1}{3} \\ 0 & otherwise \end{cases}$$

where  $\frac{\sigma_m}{\sigma_{eq}}$  is the stress triaxiality,  $r_d$  is damage threshold,  $S$  is a material constant, and  $Y$  is strain energy density release rate.

$$Y = \frac{1}{2} \boldsymbol{\varepsilon}^{el} : \mathbf{D}^{el} : \boldsymbol{\varepsilon}^{el}$$

Where  $\mathbf{D}^{el}$  represents the fourth-order elasticity tensor,  $\boldsymbol{\varepsilon}^{el}$  is elastic strain. And  $t$  is a material constant, introduced by Dufailly and Lemaitre [1995], to provide additional degree of freedom for modeling low-cycle fatigue ( $t=1$  in Lemaitre [1992]). Dufailly and Lemaitre [1995] also proposed a simplified method to fit experimental results and get  $S$  and  $t$ .

The equivalent Mises stress is defined as

$$\bar{\sigma}(s_e) = \sqrt{\frac{3}{2} s_e : s_e} = \sqrt{\frac{3}{2}} \|s_e\|$$

The model assumes associated plastic flow

$$\dot{\boldsymbol{\varepsilon}}^{pl} = \frac{\partial F}{\partial \boldsymbol{\sigma}} d\lambda = \frac{3}{2} \frac{s_e}{\bar{\sigma}} d\lambda$$

Where  $d\lambda$  is the plastic consistency parameter. The evolution of the kinematic component of the model is defined as [Armstrong and Frederick 1966]:

$$\begin{cases} \dot{\boldsymbol{\alpha}}_j = \frac{2}{3} C_j \dot{\boldsymbol{\varepsilon}}^{pl} - \gamma_j \boldsymbol{\alpha}_j \dot{\varepsilon}^{pl} & IDEP=0 \\ \dot{\boldsymbol{\alpha}}_j = (1-D) \left( \frac{2}{3} C_j \dot{\boldsymbol{\varepsilon}}^{pl} - \gamma_j \boldsymbol{\alpha}_j \dot{\varepsilon}^{pl} \right) & IDEP=1 \end{cases}$$

The damaged plastic strain is accumulated as

$$\begin{cases} r = \int \dot{\varepsilon}^{pl} & IDEP=0 \\ r = \int (1-D) \dot{\varepsilon}^{pl} & IDEP=1 \end{cases}$$

where  $\dot{\varepsilon}^{pl}$  is the equivalent plastic strain rate

$$\dot{\bar{\epsilon}}^{pl} = \sqrt{\frac{2}{3} \dot{\epsilon}^{pl} : \dot{\epsilon}^{pl}}$$

where  $\dot{\epsilon}^{pl}$  represents the rate of plastic flow.

Strain rate is accounted for using the Cowper and Symonds model which scales the yield stress with the factor

$$1 + \left(\frac{\dot{\epsilon}}{C}\right)^{1/p}$$

where  $\dot{\epsilon}$  is the strain rate.

Table 153.1 shows the difference between MAT 153 and MAT 104/105. MAT 153 is less computationally expensive than MAT 104/105. Kinematic hardening, which already exists in MAT 103, is included in MAT 153, but not in MAT 104/105.

	<b>MAT 153</b>	<b>MAT 104</b>	<b>MAT 105</b>
<b>Computational cost</b>	1.0	3.0	3.0
<b>Isotropic hardening</b>	One component	Two components	One component
<b>Kinematic hardening</b>	Two components	N/A	N/A
<b>Output stress</b>	$\tilde{\sigma}$ IDS=0 $\tilde{\sigma}(1-D)$ IDS=1	$\tilde{\sigma}(1-D)$	$\tilde{\sigma}(1-D)$
<b>Damaged plastic strain</b>	$r = \int \dot{\bar{\epsilon}}^{pl}$ IDEP=0 $r = \int (1-D) \dot{\bar{\epsilon}}^{pl}$ IDEP=1	$r = \int (1-D) \dot{\bar{\epsilon}}^{pl}$	$r = \int (1-D) \dot{\bar{\epsilon}}^{pl}$
<b>Accumulation when</b>	$\frac{\sigma_m}{\sigma_{eq}} > -\frac{1}{3}$	$\sigma_1 > 0$	$\sigma_1 > 0$
<b>Isotropic plasticity</b>	Yes	Yes	Yes
<b>Anisotropic plasticity</b>	No	Yes	No
<b>Isotropic damage</b>	Yes	Yes	Yes
<b>Anisotropic damage</b>	No	Yes	No

**Table 153.1** Difference between MAT 153 and MAT 104/105

**\*MAT\_DESHPANDE\_FLECK\_FOAM**

This is material type 154 for solid elements. This material is for modeling aluminum foam used as a filler material in aluminum extrusions to enhance the energy absorbing capability of the extrusion. Such energy absorbers are used in vehicles to dissipate energy during impact. This model was developed by Reyes, Hopperstad, Berstad, and Langseth [2002] and is based on the foam model by Deshpande and Fleck [2000].

Card 1            1            2            3            4            5            6            7            8

Variable	MID	RHO	E	PR	ALPHA	GAMMA		
Type	A8	F	F	F	F	F		
Default	none	none	none	none	none	none		

Card 2            1            2            3            4            5            6            7            8

Variable	EPSD	ALPHA2	BETA	SIGP	DERFI	CFAIL	PFAIL	NUM
Type	F	F	F	F	F	F	F	F
Default	none	none	none	none	none	none	none	none

<u>VARIABLE</u>	<u>DESCRIPTION</u>
MID	Material identification. A unique number or label not exceeding 8 characters must be specified.
RHO	Mass density.
E	Young's modulus.
PR	Poisson's ratio.
ALPHA	Controls shape of yield surface.
GAMMA	See remarks.
EPSD	Densification strain.



VARIABLE	DESCRIPTION
ALPHA2	See remarks.
BETA	See remarks.
SIGP	See remarks.
DERFI	Type of derivation used in material subroutine EQ.0: Numerical derivation EQ.1: Analytical derivation
CFAIL	Failure volumetric strain.
PFAIL	Failure principal stress. Must be sustained NUM (>0) timesteps to fail element.
NUM	Number of timesteps at or above PFAIL to trigger element failure.

### **Remarks:**

The yield stress function  $\Phi$  is defined by:

$$\Phi = \hat{\sigma} - \sigma_y$$

The equivalent stress  $\hat{\sigma}$  is given by:

$$\hat{\sigma}^2 = \frac{\sigma_{VM}^2 + \alpha^2 \sigma_m^2}{1 + \left(\frac{\alpha}{3}\right)^2}$$

where,  $\sigma_{VM}$ , is the von Mises effective stress:

$$\sigma_{VM} = \sqrt{\frac{2}{3} \sigma^{dev} : \sigma^{dev}}$$

In this equation  $\sigma_m$  and  $\sigma^{dev}$  are the mean and deviatoric stress:

$$\sigma^{dev} = \sigma - \sigma_m I$$

The yield stress  $\sigma_y$  can be expressed as:

$$\sigma_y = \sigma_p + \gamma \frac{\hat{\varepsilon}}{\varepsilon_D} + \alpha_2 \ln \left( \frac{1}{1 - \left( \frac{\hat{\varepsilon}}{\varepsilon_D} \right)^\beta} \right)$$

Here,  $\sigma_p$ ,  $\alpha_2$ ,  $\gamma$  and  $\beta$  are material parameters. The densification strain  $\varepsilon_D$  is defined as:

$$\varepsilon_D = -\ln \left( \frac{\rho_f}{\rho_{f0}} \right)$$

where  $\rho_f$  is the foam density and  $\rho_{f0}$  is the density of the virgin material.

\*MAT\_PLASTICITY\_COMPRESSION\_TENSION\_EOS

This is Material Type 155. An isotropic elastic-plastic material where unique yield stress versus plastic strain curves can be defined for compression and tension. Also, failure can occur based on a plastic strain or a minimum time step size. Rate effects on the yield stress are modeled either by using the Cowper-Symonds strain rate model or by using two load curves that scale the yield stress values in compression and tension, respectively. Material rate effects, which are independent of the plasticity model, are based on a 6-term Prony series Maxwell mode that generates an additional stress tensor. The viscous stress tensor is superimposed on the stress tensor generated by the plasticity. Pressure is defined by an equation of state, which is required to utilize this model. This model is applicable to solid elements and SPH.

Card 1            1            2            3            4            5            6            7            8

Variable	MID	RO	E	PR	C	P	FAIL	TDEL
Type	A8	F	F	F	F	F	F	F
Default	none	none	none	none	0	0	10.E+20	0

Card 2            1            2            3            4            5            6            7            8

Variable	LCIDC	LCIDT	LCSRC	LCSRT	SRFLAG			
Type	I	I	I	I	F			
Default	0	0	0	0	0			

Card 3            1            2            3            4            5            6            7            8

Variable	PC	PT	PCUTC	PCUTT	PCUTF			
Type	F	F	F	F	F			
Default	0	0	0	0	0			

Card 4            1            2            3            4            5            6            7            8

Variable	K							
Type	F							

**Card Format for viscoelastic constants. Up to 6 cards may be input. A keyword card (with a "\*" in column 1) terminates this input if less than 6 cards are used.**

Optional            1            2            3            4            5            6            7            8  
Cards

Variable	GI	BETAI						
Type	F	F						

<u>VARIABLE</u>	<u>DESCRIPTION</u>
MID	Material identification. A unique number or label not exceeding 8 characters must be specified.
RO	Mass density.
E	Young's modulus.
PR	Poisson's ratio.
C	Strain rate parameter, C, see formula below.
P	Strain rate parameter, P, see formula below.
FAIL	Failure flag. LT.0.0: User defined failure subroutine, matusr_24 in dyn21.F, is called to determine failure EQ.0.0: Failure is not considered. This option is recommended if failure is not of interest since many calculations will be saved. GT.0.0: Plastic strain to failure. When the plastic strain reaches this value, the element is deleted from the calculation.
TDEL	Minimum time step size for automatic element deletion.
LCIDC	Load curve ID defining yield stress versus effective plastic strain in compression.

<u>VARIABLE</u>	<u>DESCRIPTION</u>
LCIDT	Load curve ID defining yield stress versus effective plastic strain in tension.
LCSRC	Optional load curve ID defining strain rate scaling effect on yield stress when the material is in compression.
LCSRT	Optional load curve ID defining strain rate scaling effect on yield stress when the material is in tension.
SRFLAG	Formulation for rate effects: EQ.0.0: Total strain rate, EQ.1.0: Deviatoric strain rate.
PC	Compressive mean stress (pressure) at which the yield stress follows load curve ID, LCIDC. If the pressure falls between PC and PT a weighted average of the two load curves is used.
PT	Tensile mean stress at which the yield stress follows load curve ID, LCIDT.
PCUTC	Pressure cut-off in compression. When the pressure cut-off is reached the deviatoric stress tensor is set to zero and the pressure remains at its compressive value. Like the yield stress, PCUTC is scaled to account for rate effects.
PCUTT	Pressure cut-off in tension. When the pressure cut-off is reached the deviatoric stress tensor and tensile pressure is set to zero. Like the yield stress, PCUTT is scaled to account for rate effects.
PCUTF	Pressure cut-off flag. EQ.0.0: Inactive, EQ.1.0: Active.
K	Optional bulk modulus for the viscoelastic material. If nonzero a Kelvin type behavior will be obtained. Generally, K is set to zero.
GI	Optional shear relaxation modulus for the ith term
BETAI	Optional shear decay constant for the ith term

**Remarks:**

The stress strain behavior follows a different curve in compression than it does in tension. Tension is determined by the sign of the mean stress where a positive mean stress (i.e., a negative pressure) is indicative of tension. Two curves must be defined giving the yield stress versus effective plastic strain for both the tension and compression regimes.

Mean stress is an invariant which can be expressed as  $(\sigma_x + \sigma_y + \sigma_z)/3$ . PC and PT define a range of mean stress values within which interpolation is done between the tensile yield surface and compressive yield surface. PC and PT are not true material properties but are just a numerical convenience so that the transition from one yield surface to the other is not abrupt as the sign of the mean stress changes. Both PC and PT are input as positive values as it is implied that PC is a compressive mean stress value and PT is tensile mean stress value.

Strain rate may be accounted for using the Cowper and Symonds model which scales the yield stress with the factor:

$$1 + \left( \frac{\dot{\epsilon}}{C} \right)^{1/p}$$

where  $\dot{\epsilon}$  is the strain rate.  $\dot{\epsilon} = \sqrt{\dot{\epsilon}_{ij} \dot{\epsilon}_{ij}}$ .

\*MAT\_MUSCLE

This is material type 156 for truss elements. This material is a Hill-type muscle model with activation and a parallel damper. Also, see \*MAT\_SPRING\_MUSCLE where a description of the theory is available.

Card 1            1            2            3            4            5            6            7            8

Variable	MID	RO	SNO	SRM	PIS	SSM	CER	DMP
Type	A8	F	F	F	F	F	F	F
Default								

Card 2            1            2            3            4            5            6            7            8

Variable	ALM	SFR	SVS	SVR	SSP			
Type	F	F	F	F	F			
Default	0.0	1.0	1.0	1.0	0.0			

VARIABLE	DESCRIPTION
MID	Material identification. A unique number or label not exceeding 8 characters must be specified.
RO	Material density in the initial undeformed configuration.
SNO	Initial stretch ratio, $\frac{l}{l_0}$ , i.e., the current length as defined by the nodal points at t=0 divided by the initial length. The density for the nodal mass calculation is RO/SNO, or $\frac{l_0 \rho}{l}$ .
SRM	Maximum strain rate.
PIS	Peak isometric stress corresponding to the dimensionless value of unity in the dimensionless stress versus strain function, see SSP below.

VARIABLE	DESCRIPTION
SSM	Strain when the dimensionless stress versus strain function, <i>SSP</i> below, reaches its maximum stress value.
CER	Constant, governing the exponential rise of <i>SSP</i> . Required if <i>SSP</i> =0.
DMP	Damping constant.
ALM	Activation level vs. time. LT.0: absolute value gives load curve ID GE.0: constant value of <i>ALM</i> is used
SFR	Scale factor for strain rate maximum vs. the stretch ratio, $\frac{l}{l_0}$ .  LT.0: absolute value gives load curve ID GE.0: constant value of 1.0 is used
SVS	Active dimensionless tensile stress vs. the stretch ratio, $\frac{l}{l_0}$ .  LT.0: absolute value gives load curve ID GE.0: constant value of 1.0 is used
SVR	Active dimensionless tensile stress vs. the normalized strain rate, $\frac{\dot{l}}{l_0}$ .  LT.0: absolute value gives load curve ID GE.0: constant value of 1.0 is used
SSP	Isometric dimensionless stress vs. the stretch ratio, $\frac{l}{l_0}$ for the parallel elastic element. LT.0: absolute value gives load curve ID or table ID (see below) EQ.0: exponential function is used (see below) GT.0: constant value of 0.0 is used

**Remarks:**

The material behavior of the muscle model is adapted from material\_S15, the spring muscle model and treated here as a standard material. The initial length of muscle is calculated automatically. The force, relative length and shortening velocity are replaced by stress, strain and strain rate. A new parallel damping element is added.

The strain and normalized strain rate are defined respectively as



$$\varepsilon = \frac{l}{l_0} - 1 = L - 1$$

$$\dot{\varepsilon} = \frac{\dot{l}}{l_0 \dot{\varepsilon}_{\max}} = \frac{V^M}{l_0 * (SRM * SFR)} = \frac{V^M}{(l_0 * SRM) * SFR} = \frac{V^M}{V_{\max} * SFR} = V$$

where  $l_0 =$ , is the original muscle length.

From the relation above, it is known:

$$l_0 = \frac{l_0}{1 + \varepsilon_0}$$

where  $\varepsilon_0 = SNO$ ;  $l_0 =$  muscle length at time 0.

Stress of Contractile Element is:

$$\sigma_1 = \sigma_{\max} a(t) f(L) g(\dot{\varepsilon})$$

where  $\sigma_{\max} = PIS$ ;  $a(t) = ALM$ ;  $f(L) = SVS$ ;  $g(\dot{\varepsilon}) = SVR$ .

Stress of Passive Element is:

$$\sigma_2 = \sigma_{\max} h(\varepsilon)$$

$$\text{For exponential relationship (SSP=0): } h(\varepsilon) = \begin{cases} 0 & \varepsilon \leq 0 \\ \frac{1}{\exp(c)-1} \left[ \exp\left(\frac{c\varepsilon}{L_{\max}}\right) - 1 \right] & \varepsilon > 0 \quad c \neq 0 \\ \varepsilon / L_{\max} & \varepsilon > 0 \quad c = 0 \end{cases}$$

where  $L_{\max} = 1 + SSM$ ; and  $c = CER$ .

For  $SSP < 0$ , the absolute value gives a load curve ID or table ID. The load curve defines isometric dimensionless stress  $h$  versus stretch ratio  $l/l_0$ . The table defines for each normalized strain rate  $\dot{\varepsilon}$  a load curve giving the isometric dimensionless stress  $h$  versus stretch ratio  $l/l_0$  for that rate.

Stress of Damping Element is:

$$\sigma_3 = D\varepsilon\dot{\varepsilon}$$

Total Stress is:

$$\sigma = \sigma_1 + \sigma_2 + \sigma_3$$

**\*MAT\_ANISOTROPIC\_ELASTIC\_PLASTIC**

This is Material Type 157. This material model is a combination of the anisotropic elastic material model (MAT\_002) and the anisotropic plastic material model (MAT\_103\_P).

Card 1            1            2            3            4            5            6            7            8

Variable	MID	RO	SIGY	LCSS	QR1	CR1	QR2	CR2
Type	A8	F	F	F	F	F	F	F

Card 2            1            2            3            4            5            6            7            8

Variable	C11	C12	C13	C14	C15	C16	C22	C23
Type	F	F	F	F	F	F	F	F

Card 3            1            2            3            4            5            6            7            8

Variable	C24	C25	C26	C33	C34	C35	C36	C44
Type	F	F	F	F	F	F	F	F

Card 4            1            2            3            4            5            6            7            8

Variable	C45	C46	C55	C56	C66	R00	R45	R90
Type	F	F	F	F	F	F	F	F

Card 5            1            2            3            4            5            6            7            8

Variable	S11	S22	S33	S12	AOPT			
Type	F	F	F	F	F			

Card 6            1            2            3            4            5            6            7            8

Variable	Not used	Not used	Not used	A1	A2	A3		
Type				F	F	F		

Card 7            1            2            3            4            5            6            7            8

Variable	V1	V2	V3	D1	D2	D3	BETA	
Type	F	F	F	F	F	F	F	

**VARIABLE**

**DESCRIPTION**

- MID            Material identification. A unique number or label not exceeding 8 characters must be specified.
- RO            Mass density.
- SIGY            Initial yield stress
- LCSS            Load curve ID. The load curve ID defines effective stress versus effective plastic strain. QR1, CR1, QR2, and CR2 are ignored with this option.
- QR1            Isotropic hardening parameter *Qr1*
- CR1            Isotropic hardening parameter *Cr1*
- QR2            Isotropic hardening parameter *Qr2*
- CR2            Isotropic hardening parameter *Cr2*

<u>VARIABLE</u>	<u>DESCRIPTION</u>
CIJ	The I, J term in the 6×6 anisotropic constitutive matrix. Note that 1 corresponds to the <i>a</i> material direction, 2 to the <i>b</i> material direction, and 3 to the <i>c</i> material direction.
R00	$R_{00}$ for shell (Default=1.0)
R45	$R_{45}$ for shell (Default=1.0)
R90	$R_{90}$ for shell (Default=1.0)
S11	Yield stress in local-x direction. This input is ignored if (R00, R45, R90) > 0.
S22	Yield stress in local-y direction. This input is ignored if (R00, R45, R90) > 0.
S33	Yield stress in local-z direction. This input is ignored if (R00, R45, R90) > 0.
S12	Yield stress in local-xy direction. This input is ignored if (R00, R45, R90) > 0.
AOPT	Material axes option (see MAT_OPTION TROPIC_ELASTIC for a more complete description. EQ.0.0: locally orthotropic with material axes determined by element nodes as shown in Figure 2.1, and then rotated about the shell element normal by the angle BETA. Nodes 1, 2, and 4 of an element are identical to the nodes used for the definition of a coordinate system as by *DEFINE_COORDINATE_NODES. EQ.2.0: globally orthotropic with material axes determined by vectors defined below, as with *DEFINE_COORDINATE_VECTOR. EQ.3.0: locally orthotropic material axes determined by rotating the material axes about the element normal by an angle, BETA, from a line in the plane of the element defined by the cross product of the vector <b>v</b> with the element normal. LT.0.0: the absolute value of AOPT is a coordinate system ID number (CID on *DEFINE_COORDINATE_NODES, *DEFINE_COORDINATE_SYSTEM or *DEFINE_COORDINATE_VECTOR). Available in R3 version of 971 and later.
A1, A2, A3	a1, a2, a3 define components of vector <b>a</b> for AOPT=2.
D1, D2, D3	d1, d2, d3 define components of vector <b>d</b> for AOPT=2.
V1, V2, V3	v1, v2, v3 define components of vector <b>v</b> for AOPT=3 and 4.

---

<u>VARIABLE</u>	<u>DESCRIPTION</u>
BETA	Material angle in degrees for AOPT = 0 and 3, may be overwritten on the element card, see *ELEMENT_SHELL_BETA.



**\*MAT\_RATE\_SENSITIVE\_COMPOSITE\_FABRIC**

This is Material Type 158. Depending on the type of failure surface, this model may be used to model rate sensitive composite materials with unidirectional layers, complete laminates, and woven fabrics. A viscous stress tensor, based on an isotropic Maxwell model with up to six terms in the Prony series expansion, is superimposed on the rate independent stress tensor of the composite fabric. The viscous stress tensor approach should work reasonably well if the stress increases due to rate effects are up to 15% of the total stress. This model is implemented for both shell and thick shell elements. The viscous stress tensor is effective at eliminating spurious stress oscillations.

Card 1            1            2            3            4            5            6            7            8

Variable	MID	RO	EA	EB	(EC)	PRBA	TAU1	GAMMA1
Type	A8	F	F	F	F	F	F	F

Card 2            1            2            3            4            5            6            7            8

Variable	GAB	GBC	GCA	SLIMT1	SLIMC1	SLIMT2	SLIMC2	SLIMS
Type	F	F	F	F	F	F	F	F

Card 3            1            2            3            4            5            6            7            8

Variable	AOPT	TSIZE	ERODS	SOFT	FS			
Type	F	F	F	F	F			

Card 4            1            2            3            4            5            6            7            8

Variable	XP	YP	ZP	A1	A2	A3		
Type	F	F	F	F	F	F		

Card 5            1            2            3            4            5            6            7            8

Variable	V1	V2	V3	D1	D2	D3	BETA	
Type	F	F	F	F	F	F	F	

Card 6            1            2            3            4            5            6            7            8

Variable	E11C	E11T	E22C	E22T	GMS			
Type	F	F	F	F	F			

Card 7            1            2            3            4            5            6            7            8

Variable	XC	XT	YC	YT	SC			
Type	F	F	F	F	F			

Card 8            1            2            3            4            5            6            7            8

Variable	K							
Type	F							

**Card Format for viscoelastic constants. Up to 6 cards may be input. A keyword card (with a "\*" in column 1) terminates this input if less than 6 cards are used.**

Cards opt.        1            2            3            4            5            6            7            8

Variable	GI	BETA1						
Type	F	F						

<u>VARIABLE</u>	<u>DESCRIPTION</u>
MID	Material identification. A unique number or label not exceeding 8 characters must be specified.
RO	Mass density
EA	$E_a$ , Young's modulus - longitudinal direction
EB	$E_b$ , Young's modulus - transverse direction
(EC)	$E_c$ , Young's modulus - normal direction (not used)
PRBA	$\nu_{ba}$ , Poisson's ratio ba
TAU1	$\tau_1$ , stress limit of the first slightly nonlinear part of the shear stress versus shear strain curve. The values $\tau_1$ and $\gamma_1$ are used to define a curve of shear stress versus shear strain. These values are input if FS, defined below, is set to a value of -1.
GAMMA1	$\gamma_1$ , strain limit of the first slightly nonlinear part of the shear stress versus shear strain curve.
GAB	$G_{ab}$ , shear modulus ab
GBC	$G_{bc}$ , shear modulus bc
GCA	$G_{ca}$ , shear modulus ca
SLIMT1	Factor to determine the minimum stress limit after stress maximum (fiber tension).
SLIMC1	Factor to determine the minimum stress limit after stress maximum (fiber compression).
SLIMT2	Factor to determine the minimum stress limit after stress maximum (matrix tension).
SLIMC2	Factor to determine the minimum stress limit after stress maximum (matrix compression).
SLIMS	Factor to determine the minimum stress limit after stress maximum (shear).



VARIABLE	DESCRIPTION
AOPT	<p>Material axes option (see <i>MAT_OPTION</i> TROPIC_ELASTIC for a more complete description):</p> <p>EQ.0.0: locally orthotropic with material axes determined by element nodes 1, 2, and 4, as with *DEFINE_COORDINATE_NODES, and then rotated about the shell element normal by the angle BETA.</p> <p>EQ.2.0: globally orthotropic with material axes determined by vectors defined below, as with *DEFINE_COORDINATE_VECTOR.</p> <p>EQ.3.0: locally orthotropic material axes determined by rotating the material axes about the element normal by an angle (BETA) from a line in the plane of the element defined by the cross product of the vector <math>\mathbf{v}</math> with the element normal.</p> <p>LT.0.0: the absolute value of AOPT is a coordinate system ID number (CID on *DEFINE_COORDINATE_NODES, *DEFINE_COORDINATE_SYSTEM or *DEFINE_COORDINATE_VECTOR). Available in R3 version of 971 and later.</p>
TSIZE	Time step for automatic element deletion.
ERODS	Maximum effective strain for element layer failure. A value of unity would equal 100% strain.
SOFT	Softening reduction factor for strength in the crashfront.
FS	<p>Failure surface type:</p> <p>EQ.1.0: smooth failure surface with a quadratic criterion for both the fiber (a) and transverse (b) directions. This option can be used with complete laminates and fabrics.</p> <p>EQ.0.0: smooth failure surface in the transverse (b) direction with a limiting value in the fiber (a) direction. This model is appropriate for unidirectional (UD) layered composites only.</p> <p>EQ.-1: faceted failure surface. When the strength values are reached then damage evolves in tension and compression for both the fiber and transverse direction. Shear behavior is also considered. This option can be used with complete laminates and fabrics.</p>
XP YP ZP	Define coordinates of point $\mathbf{p}$ for AOPT = 1.
A1 A2 A3	Define components of vector $\mathbf{a}$ for AOPT = 2.
V1 V2 V3	Define components of vector $\mathbf{v}$ for AOPT = 3.
D1 D2 D3	Define components of vector $\mathbf{d}$ for AOPT = 2.

<b>VARIABLE</b>	<b>DESCRIPTION</b>
BETA	Material angle in degrees for AOPT = 0 and 3, may be overridden on the element card, see *ELEMENT_SHELL_BETA.
E11C	Strain at longitudinal compressive strength, a-axis.
E11T	Strain at longitudinal tensile strength, a-axis.
E22C	Strain at transverse compressive strength, b-axis.
E22T	Strain at transverse tensile strength, b-axis.
GMS	Strain at shear strength, ab plane.
XC	Longitudinal compressive strength
XT	Longitudinal tensile strength, see below.
YC	Transverse compressive strength, b-axis, see below.
YT	Transverse tensile strength, b-axis, see below.
SC	Shear strength, ab plane.
K	Optional bulk modulus for the viscoelastic material. If nonzero a Kelvin type behavior will be obtained. Generally, K is set to zero.
GI	Optional shear relaxation modulus for the ith term
BETAI	Optional shear decay constant for the ith term

**Remarks:**

See the remark for material type 58, \*MAT\_LAMINATED\_COMPOSITE\_FABRIC, for the treatment of the composite material.

Rate effects are taken into account through a Maxwell model using linear viscoelasticity by a convolution integral of the form:

$$\sigma_{ij} = \int_0^t g_{ijkl}(t-\tau) \frac{\partial \varepsilon_{kl}}{\partial \tau} d\tau$$

where  $g_{ijkl}(t-\tau)$  is the relaxation functions for the different stress measures. This stress is added to the stress tensor determined from the strain energy functional. Since we wish to include only simple rate effects, the relaxation function is represented by six terms from the Prony series:

$$g(t) = \sum_{m=1}^N G_m e^{-\beta_m t}$$

We characterize this in the input by the shear moduli,  $G_i$ , and decay constants,  $\beta_i$ . An arbitrary number of terms, not exceeding 6, may be used when applying the viscoelastic model. The composite failure is not directly affected by the presence of the viscous stress tensor.

DRAFT

**\*MAT\_CSCM\_{OPTION}**

This is material type 159. This is a smooth or continuous surface cap model and is available for solid elements in LS-DYNA. The user has the option of inputting his own material properties (<BLANK> option), or requesting default material properties for normal strength concrete (CONCRETE).

Available options include:

<BLANK>

CONCRETE

such that the keyword cards appear as:

**\*MAT\_CSCM**

**\*MAT\_CSCM\_CONCRETE**

**Define the next two cards for all options:**

Card 1            1            2            3            4            5            6            7            8

Variable	MID	RO	NPLOT	INCRE	IRATE	ERODE	RECOV	ITRETRC
Type	A8	F	I	F	I	F	F	I

Card 2            1            2            3            4            5            6            7            8

Variable	PRED							
Type	F							

**Define the following card for the CONCRETE option. Do not define for the <BLANK> option.**

Card 3            1            2            3            4            5            6            7            8

Variable	FPC	DAGG	UNITS					
Type	F	F	I					

Define the following cards for the <BLANK> option. Do not define for CONCRETE.

Card 3            1            2            3            4            5            6            7            8

Variable	G	K	ALPHA	THETA	LAMDA	BETA	NH	CH
Type	F	F	F	F	F	F	F	F

Card 4            1            2            3            4            5            6            7            8

Variable	ALPHA1	THETA1	LAMDA1	BETA1	ALPHA2	THETA2	LAMDA2	BETA2
Type	F	F	F	F	F	F	F	F

Card 5            1            2            3            4            5            6            7            8

Variable	R	X0	W	D1	D2			
Type	F	F	F	F	F			

Card 6            1            2            3            4            5            6            7            8

Variable	B	GFC	D	GFT	GFS	PWRC	PWRT	PMOD
Type	F	F	F	F	F	F	F	F

Card 7            1            2            3            4            5            6            7            8

Variable	ETA0C	NC	ETA0T	NT	OVERC	OVERT	SRATE	REPOW
Type	F	F	F	F	F	F	F	F

VARIABLE	DESCRIPTION
MID	Material identification. A unique number or label not exceeding 8 characters must be specified.
RO	Mass density.
NPLOT	Controls what is written as component 7 to the d3plot database. LS-Prepost always blindly labels this component as effective plastic strain: EQ.1: Maximum of brittle and ductile damage (default). EQ.2: Maximum of brittle and ductile damage, with recovery of brittle damage. EQ.3: Brittle damage. EQ.4: Ductile damage. EQ.5: $\kappa$ (intersection of cap with shear surface). EQ.6: $X_0$ (intersection of cap with pressure axis). EQ.7: $\varepsilon_v^p$ (plastic volume strain).
INCRE	Maximum strain increment for subincrementation. If left blank, a default value is set during initialization based upon the shear strength and stiffness.
IRATE	Rate effects options: EQ.0: Rate effects model turned off (default). EQ.1: Rate effects model turned on.
ERODE	Elements erode when damage exceeds 0.99 and the maximum principal strain exceeds ERODE-1.0. For erosion that is independent of strain, set ERODE equal to 1.0. Erosion does not occur if ERODE is less than 1.0.
RECOV	The modulus is recovered in compression when RECOV is equal to 0 (default). The modulus remains at the brittle damage level when RECOV is equal to 1. Partial recovery is modeled for values of RECOV between 0 and 1. Two options are available: EQ.1: Input a value between 0 and 1. Recovery is based upon the sign of the pressure invariant only. EQ.2: Input a value between 10 and 11. Recovery is based upon the sign of both the pressure and volumetric strain. In this case, RECOV=RECOV-10, and a flag is set to request the volumetric strain check.
IRETRC	Cap retraction option: EQ.0: Cap does not retract (default). EQ.1: Cap retracts.
PRED	Pre-existing damage ( $0 \leq \text{PreD} < 1$ ). If left blank, the default is zero (no pre-existing damage).

Define for the CONCRETE option. Note that the default concrete input parameters are for normal strength concrete with unconfined compression strengths between about 28 and 58 MPa.

VARIABLE	DESCRIPTION
FPC	Unconfined compression strength, $f'_c$ . If left blank, default is 30 MPa.
DAGG	Maximum aggregate size, Dagg. If left blank, default is 19 mm (3/4 inch).
UNITS	Units options: EQ.0: GPa, mm, msec, Kg/mm <sup>3</sup> , kN EQ.1: MPa, mm, msec, g/mm <sup>3</sup> , N EQ.2: MPa, mm, sec, Mg/mm <sup>3</sup> , N EQ.3: Psi, inch, sec, lbf-s <sup>2</sup> /inch <sup>4</sup> , lbf EQ.4: Pa, m, sec, kg/m <sup>3</sup> , N

Define for <BLANK> option only.

VARIABLE	DESCRIPTION
G	Shear modulus.
K	Bulk modulus.
ALPHA	Tri-axial compression surface constant term, $\alpha$ .
THETA	Tri-axial compression surface linear term, $\theta$ .
LAMDA	Tri-axial compression surface nonlinear term, $\lambda$ .
BETA	Tri-axial compression surface exponent, $\beta$ .
ALPHA1	Torsion surface constant term, $\alpha_1$ .
THETA1	Torsion surface linear term, $\theta_1$ .
LAMDA1	Torsion surface nonlinear term, $\lambda_1$ .
BETA1	Torsion surface exponent, $\beta_1$ .
ALPHA2	Tri-axial extension surface constant term, $\alpha_2$ .
THETA2	Tri-axial extension surface linear term, $\theta_2$ .
LAMDA2	Tri-axial extension surface nonlinear term, $\lambda_2$ .
BETA2	Tri-axial extension surface exponent, $\beta_2$ .

VARIABLE	DESCRIPTION
NH	Hardening initiation, $N_H$ .
CH	Hardening rate, $C_H$ .
R	Cap aspect ratio, $R$ .
X0	Cap initial location, $X_0$ .
W	Maximum plastic volume compaction, $W$ .
D1	Linear shape parameter, $D_1$ .
D2	Quadratic shape parameter, $D_2$ .
B	Ductile shape softening parameter, $B$ .
GFC	Fracture energy in uniaxial stress $G_{fc}$ .
D	Brittle shape softening parameter, $D$ .
GFT	Fracture energy in uniaxial tension, $G_{ft}$ .
GFS	Fracture energy in pure shear stress, $G_{fs}$ .
PWRC	Shear-to-compression transition parameter.
PWRT	Shear-to-tension transition parameter.
PMOD	Modify moderate pressure softening parameter.
ETA0C	Rate effects parameter for uniaxial compressive stress, $\eta_{0c}$ .
NC	Rate effects power for uniaxial compressive stress, $N_c$ .
ETA0T	Rate effects parameter for uniaxial tensile stress, $\eta_{0t}$ .
NT	Rate effects power for uniaxial tensile stress, $N_t$ .
OVERC	Maximum overstress allowed in compression.
OVERT	Maximum overstress allowed in tension.
SRATE	Ratio of effective shear stress to tensile stress fluidity parameters.
REPOW	Power which increases fracture energy with rate effects.



**Remarks:****Model Formulation and Input Parameters**

This is a cap model with a smooth intersection between the shear yield surface and hardening cap, as shown in Figure 159.1. The initial damage surface coincides with the yield surface. Rate effects are modeled with viscoplasticity. For a complete theoretical description, with references and example problems see [Murray 2007] and [Murray, Abu-Odeh and Bligh 2007].

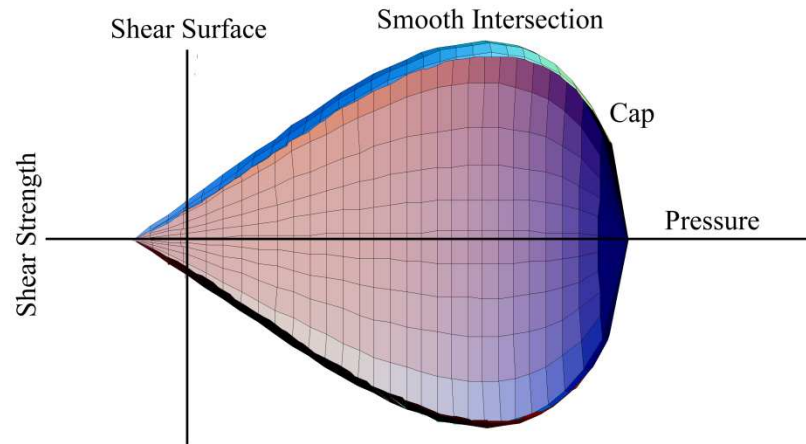

**Figure 159.1.** General shape of the concrete model yield surface in two-dimensions.

*Stress Invariants.* The yield surface is formulated in terms of three stress invariants:  $J_1$  is the first invariant of the stress tensor,  $J_2'$  is the second invariant of the deviatoric stress tensor, and  $J_3'$  is the third invariant of the deviatoric stress tensor. The invariants are defined in terms of the deviatoric stress tensor,  $S_{ij}$  and pressure,  $P$ , as follows:

$$\begin{aligned} J_1 &= 3P \\ J_2' &= \frac{1}{2} S_{ij} S_{ij} \\ J_3' &= \frac{1}{3} S_{ij} S_{jk} S_{ki} \end{aligned}$$

*Plasticity Surface.* The three invariant yield function is based on these three invariants, and the cap hardening parameter,  $\kappa$ , as follows:

$$f(J_1, J_2', J_3', \kappa) = J_2' - \mathfrak{R}^2 F_f^2 F_c$$

Here  $F_f$  is the shear failure surface,  $F_c$  is the hardening cap, and  $\mathfrak{R}$  is the Rubin three-invariant reduction factor. The cap hardening parameter  $\kappa$  is the value of the pressure invariant at the intersection of the cap and shear surfaces.

Trial elastic stress invariants are temporarily updated via the trial elastic stress tensor,  $\sigma^T$ . These are denoted  $J_1^T$ ,  $J_2^T$ , and  $J_3^T$ . Elastic stress states are modeled when  $f(J_1^T, J_2^T, J_3^T, \kappa^T) \leq 0$ . Elastic-plastic stress states are modeled when  $f(J_1^T, J_2^T, J_3^T, \kappa^T) > 0$ . In this case, the plasticity algorithm returns the stress state to the yield surface such that  $f(J_1^P, J_2^P, J_3^P, \kappa^P) = 0$ . This is accomplished by enforcing the plastic consistency condition with associated flow.

Shear Failure Surface. The strength of concrete is modeled by the shear surface in the tensile and low confining pressure regimes:

$$F_f(J_1) = \alpha - \lambda \exp^{-\beta J_1} + \theta J_1$$

Here the values of  $\alpha$ ,  $\beta$ ,  $\lambda$ , and  $\theta$  are selected by fitting the model surface to strength measurements from triaxial compression (TXC) tests conducted on plain concrete cylinders.

Rubin Scaling Function. Concrete fails at lower values of  $\sqrt{3J_2'}$  (principal stress difference) for triaxial extension (TXE) and torsion (TOR) tests than it does for TXC tests conducted at the same pressure. The Rubin scaling function  $\mathfrak{R}$  determines the strength of concrete for any state of stress relative to the strength for TXC, via  $\mathfrak{R}F_f$ . Strength in torsion is modeled as  $Q_1F_f$ . Strength in TXE is modeled as  $Q_2F_f$ , where:

$$Q_1 = \alpha_1 - \lambda_1 \exp^{-\beta_1 J_1} + \theta_1 J_1$$

$$Q_2 = \alpha_2 - \lambda_2 \exp^{-\beta_2 J_1} + \theta_2 J_1$$

Cap Hardening Surface. The strength of concrete is modeled by a combination of the cap and shear surfaces in the low to high confining pressure regimes. The cap is used to model plastic volume change related to pore collapse (although the pores are not explicitly modeled). The isotropic hardening cap is a two-part function that is either unity or an ellipse:

$$F_c(J_1, \kappa) = 1 - \frac{[J_1 - L(\kappa)] [ |J_1 - L(\kappa)| + J_1 - L(\kappa) ]}{2 [X(\kappa) - L(\kappa)]^2}$$

where  $L(\kappa)$  is defined as:

$$L(\kappa) = \begin{cases} \kappa & \text{if } \kappa > \kappa_0 \\ \kappa_0 & \text{otherwise} \end{cases}$$

The equation for  $F_c$  is equal to unity for  $J_1 \leq L(\kappa)$ . It describes the ellipse for  $J_1 > L(\kappa)$ . The intersection of the shear surface and the cap is at  $J_1 = \kappa$ .  $\kappa_0$  is the value of  $J_1$  at the initial intersection of the cap and shear surfaces before hardening is engaged (before the cap moves). The equation for  $L(\kappa)$  restrains the cap from retracting past its initial location at  $\kappa_0$ .

The intersection of the cap with the  $J_1$  axis is at  $J_1 = X(\kappa)$ . This intersection depends upon the cap ellipticity ratio  $R$ , where  $R$  is the ratio of its major to minor axes:

$$X(\kappa) = L(\kappa) + RF_f(L(\kappa))$$

The cap moves to simulate plastic volume change. The cap expands ( $X(\kappa)$  and  $\kappa$  increase) to simulate plastic volume compaction. The cap contracts ( $X(\kappa)$  and  $\kappa$  decrease) to simulate plastic volume expansion, called dilation. The motion (expansion and contraction) of the cap is based upon the hardening rule:

$$\varepsilon_v^p = W \left( 1 - \exp^{-D_1(X-X_0) - D_2(X-X_0)^2} \right)$$

Here  $\varepsilon_v^p$  the plastic volume strain,  $W$  is the maximum plastic volume strain, and  $D_1$  and  $D_2$  are model input parameters.  $X_0$  is the initial location of the cap when  $\kappa = \kappa_0$ .

The five input parameters ( $X_0$ ,  $W$ ,  $D_1$ ,  $D_2$ , and  $R$ ) are obtained from fits to the pressure-volumetric strain curves in isotropic compression and uniaxial strain.  $X_0$  determines the pressure at which compaction initiates in isotropic compression.  $R$ , combined with  $X_0$ , determines the pressure at which compaction initiates in uniaxial strain.  $D_1$ , and  $D_2$  determine the shape of the pressure-volumetric strain curves.  $W$  determines the maximum plastic volume compaction.

Shear Hardening Surface. In unconfined compression, the stress-strain behavior of concrete exhibits nonlinearity and dilation prior to the peak. Such behavior is modeled with an initial shear yield surface,  $N_H F_f$ , which hardens until it coincides with the ultimate shear yield surface,  $F_f$ . Two input parameters are required. One parameter,  $N_H$ , initiates hardening by setting the location of the initial yield surface. A second parameter,  $C_H$ , determines the rate of hardening (amount of nonlinearity).

Damage. Concrete exhibits softening in the tensile and low to moderate compressive regimes.

$$\sigma_{ij}^d = (1 - d) \sigma_{ij}^{vp}$$

A scalar damage parameter,  $d$ , transforms the viscoplastic stress tensor without damage, denoted  $\sigma^{vp}$ , into the stress tensor with damage, denoted  $\sigma^d$ . Damage accumulation is based upon two distinct formulations, which we call brittle damage and ductile damage. The initial damage threshold is coincident with the shear plasticity surface, so the threshold does not have to be specified by the user.

Ductile Damage. Ductile damage accumulates when the pressure ( $P$ ) is compressive and an energy-type term,  $\tau_c$ , exceeds the damage threshold,  $\tau_{0c}$ . Ductile damage accumulation depends upon the total strain components,  $\varepsilon_{ij}$ , as follows:

$$\tau_c = \sqrt{\frac{1}{2} \sigma_{ij} \varepsilon_{ij}}$$

The stress components  $\sigma_{ij}$  are the elasto-plastic stresses (with kinematic hardening) calculated before application of damage and rate effects.

**Brittle Damage.** Brittle damage accumulates when the pressure is tensile and an energy-type term,  $\tau_t$ , exceeds the damage threshold,  $\tau_{0t}$ . Brittle damage accumulation depends upon the maximum principal strain,  $\varepsilon_{\max}$ , as follows:

$$\tau_t = \sqrt{E \varepsilon_{\max}^2}$$

**Softening Function.** As damage accumulates, the damage parameter  $d$  increases from an initial value of zero, towards a maximum value of one, via the following formulations:

$$\begin{aligned} \text{Brittle Damage} \quad d(\tau_t) &= \frac{0.999}{D} \left[ \frac{1+D}{1+D \exp^{-C(\tau_t - \tau_{0t})}} - 1 \right] \\ \text{Ductile Damage} \quad d(\tau_c) &= \frac{dmax}{B} \left[ \frac{1+B}{1+B \exp^{-A(\tau_c - \tau_{0c})}} - 1 \right] \end{aligned}$$

The damage parameter that is applied to the six stresses is equal to the current maximum of the brittle or ductile damage parameter. The parameters A and B or C and D set the shape of the softening curve plotted as stress-displacement or stress-strain. The parameter  $dmax$  is the maximum damage level that can be attained. It is calculated internally and is less than one at moderate confining pressures. The compressive softening parameter, A, may also be reduced with confinement, using the input parameter  $pmod$ , as follows:

$$A = A(dmax + 0.001)^{pmod}$$

**Regulating Mesh Size Sensitivity.** The concrete model maintains constant fracture energy, regardless of element size. The fracture energy is defined here as the area under the stress-displacement curve from peak strength to zero strength. This is done by internally formulating the softening parameters A and C in terms of the element length,  $l$  (cube root of the element volume), the fracture energy,  $G_f$ , the initial damage threshold,  $\tau_{0t}$  or  $\tau_{0c}$ , and the softening shape parameters, D or B.

The fracture energy is calculated from up to five user-specified input parameters ( $G_{fc}$ ,  $G_{ft}$ ,  $G_{fs}$ ,  $pwrc$ ,  $pwr$ ). The user specifies three distinct fracture energy values. These are the fracture energy in uniaxial tensile stress,  $G_{ft}$ , pure shear stress,  $G_{fs}$ , and uniaxial compressive stress,  $G_{fc}$ . The model internally selects the fracture energy from equations which interpolate between the three fracture energy values as a function of the stress state (expressed via two stress invariants). The interpolation equations depend upon the user-specified input powers  $pwr$  and  $pwrc$ , as follows.

$$\text{if the pressure is tensile} \quad G_f = G_{fs} + trans(G_{ft} - G_{fs}) \quad \text{where } trans = \left( \frac{-J_1}{\sqrt{3J_2'}} \right)^{pwr}$$

$$\text{if the pressure is compressive} \quad G_f = G_{fs} + trans(G_{fc} - G_{fs}) \quad \text{where } trans = \left( \frac{J_1}{\sqrt{3J_2'}} \right)^{pwrc}$$

The internal parameter *trans* is limited to range between 0 and 1.

**Element Erosion.** An element loses all strength and stiffness as  $d \rightarrow 1$ . To prevent computational difficulties with very low stiffness, element erosion is available as a user option. An element erodes when  $d > 0.99$  and the maximum principal strain is greater than a user supplied input value, ERODE-1.0.

**Viscoplastic Rate Effects.** At each time step, the viscoplastic algorithm interpolates between the elastic trial stress,  $\sigma_{ij}^T$ , and the inviscid stress (without rate effects),  $\sigma_{ij}^P$ , to set the viscoplastic stress (with rate effects),  $\sigma_{ij}^{VP}$ :

$$\sigma_{ij}^{VP} = (1 - \gamma)\sigma_{ij}^T + \gamma\sigma_{ij}^P \quad \text{with} \quad \gamma = \frac{\Delta t / \eta}{1 + \Delta t / \eta}$$

This interpolation depends upon the effective fluidity coefficient,  $\eta$ , and the time step,  $\Delta t$ . The effective fluidity coefficient is internally calculated from five user-supplied input parameters and interpolation equations:

$$\begin{aligned} \text{if the pressure is tensile} \quad \eta &= \eta_s + \text{trans}(\eta_t - \eta_s) & \text{trans} &= \left( \frac{-J_1}{\sqrt{3J_2}} \right)^{\text{pwrt}} \\ \text{if the pressure is compressive} \quad \eta &= \eta_s + \text{trans}(\eta_c - \eta_s) & \text{trans} &= \left( \frac{J_1}{\sqrt{3J_2}} \right)^{\text{pwrc}} \\ \eta_t &= \frac{\eta_{0t}}{\dot{\epsilon}^{N_t}} & \eta_c &= \frac{\eta_{0c}}{\dot{\epsilon}^{N_c}} & \eta_s &= S_{\text{rate}}\eta_t \end{aligned}$$

The input parameters are  $\eta_{0t}$  and  $N_t$  for fitting uniaxial tensile stress data,  $\eta_{0c}$  and  $N_c$  for fitting the uniaxial compressive stress data, and  $S_{\text{rate}}$  for fitting shear stress data. The effective strain rate is  $\dot{\epsilon}$ .

This viscoplastic model may predict substantial rate effects at high strain rates ( $\dot{\epsilon} > 100$ ). To limit rate effects at high strain rates, the user may input overstress limits in tension (*overt*) and compression (*overc*). These input parameters limit calculation of the fluidity parameter, as follows:

$$\text{if } E\dot{\epsilon}\eta > \text{over} \quad \text{then} \quad \eta = \frac{\text{over}}{E\dot{\epsilon}}$$

where *over* = *overt* when the pressure is tensile, and *over* = *overc* when the pressure is compressive.

The user has the option of increasing the fracture energy as a function of effective strain rate via the *repow* input parameter, as follows:

$$G_f^{\text{rate}} = G_f \left( 1 + \frac{E\dot{\epsilon}\eta}{f'} \right)^{\text{repow}}$$

Here  $G_f^{rate}$  is the fracture energy enhanced by rate effects, and  $f'$  is the yield strength before application of rate effects (which is calculated internally by the model). The term in brackets is greater than, or equal to one, and is the approximate ratio of the dynamic to static strength.

DRAFT

\*MAT\_ALE\_INCOMPRESSIBLE

This is Material Type 160. This card allows to solve incompressible flows with the ALE solver. It should be used with the element formulation 6 and 12 in \*SECTION\_SOLID (elform=6 or 12). A projection method enforces the incompressibility condition.

Card 1            1            2            3            4            5            6            7            8

Variable	MID	RO	PC	MU				
Type	I	F	F	F				
Default	none	none	0.0	0.0				
Remarks								

Card 2            1            2            3            4            5            6            7            8

Variable	TOL	DTOUT	NCG	METH				
Type	F	F	I	I				
Default	1e-8	1e10	50	-7				
Remarks								

<u>VARIABLE</u>	<u>DESCRIPTION</u>
MID	Material ID. A unique number or label not exceeding 8 characters must be specified. Material ID is referenced in the *PART card and must be unique
RO	Material density
PC	Pressure cutoff (< or = 0.0)
MU	Dynamic viscosity coefficient
TOL	Tolerance for the convergence of the conjugate gradient

---

<u>VARIABLE</u>	<u>DESCRIPTION</u>
DTOUT	Time interval between screen outputs
NCG	Maximum number of loops in the conjugate gradient
METH	Conjugate gradient methods: EQ.-6: solves the poisson equation for the pressure EQ.-7: solves the poisson equation for the pressure increment



\*MAT\_COMPOSITE\_MSC\_{OPTION}

Available options include:

<BLANK>

DMG

These are Material Types 161 and 162. These models may be used to model the progressive failure analysis for composite materials consisting of unidirectional and woven fabric layers. The progressive layer failure criteria have been established by adopting the methodology developed by Hashin [1980] with a generalization to include the effect of highly constrained pressure on composite failure. These failure models can be used to effectively simulate fiber failure, matrix damage, and delamination behavior under all conditions - opening, closure, and sliding of failure surfaces. The model with DMG option (material 162) is a generalization of the basic layer failure model of Material 161 by adopting the damage mechanics approach for characterizing the softening behavior after damage initiation. These models require an additional license from Materials Sciences Corporation, which developed and supports these models.

Card 1 1 2 3 4 5 6 7 8

Variable	MID	RO	EA	EB	EC	PRBA	PRCA	PRCB
Type	A8	F	F	F	F	F	F	F

Card 2 1 2 3 4 5 6 7 8

Variable	GAB	GBC	GCA	AOPT	MACF			
Type	F	F	F	F	I			

Card 3 1 2 3 4 5 6 7 8

Variable	XP	YP	ZP	A1	A2	A3		
Type	F	F	F	F	F	F		

Card 4            1            2            3            4            5            6            7            8

Variable	V1	V2	V3	D1	D2	D3	BETA	
Type	F	F	F	F	F	F	F	

Card 5            1            2            3            4            5            6            7            8

Variable	SAT	SAC	SBT	SBC	SCT	SFC	SFS	SAB
Type	F	F	F	F	F	F	F	F

Card 6            1            2            3            4            5            6            7            8

Variable	SBC	SCA	SFFC	AMODEL	PHIC	E_LIMT	S_DELM	
Type	F	F	F	F	F	F	F	

Card 7            1            2            3            4            5            6            7            8

Variable	OMGMX	ECRSH	EEXPN	CERATE1	AM1			
Type	F	F	F	F	F			

**Define the following cards if and only if the option DMG is specified**

Card 8            1            2            3            4            5            6            7            8

Variable	AM2	AM3	AM4	CERATE 2	CERATE 3	CERATE 4		
Type	F	F	F	F	F	F		

<u>VARIABLE</u>	<u>DESCRIPTION</u>
MID	Material identification. A unique number or label not exceeding 8 characters must be specified.
RO	Mass density
EA	$E_a$ , Young's modulus - longitudinal direction
EB	$E_b$ , Young's modulus - transverse direction
EC	$E_c$ , Young's modulus - through thickness direction
PRBA	$\nu_{ba}$ , Poisson's ratio ba
PRCA	$\nu_{ca}$ , Poisson's ratio ca
PRCB	$\nu_{cb}$ , Poisson's ratio cb
GAB	$G_{ab}$ , shear modulus ab
GBC	$G_{bc}$ , shear modulus bc
GCA	$G_{ca}$ , shear modulus ca

VARIABLE	DESCRIPTION
AOPT	<p>Material axes option, see Figure 2.1:</p> <p>EQ.0.0: locally orthotropic with material axes determined by element nodes as shown in Figure 2.1. Nodes 1, 2, and 4 of an element are identical to the Nodes used for the definition of a coordinate system by *DEFINE_COORDINATE_NODES.</p> <p>EQ.1.0: locally orthotropic with material axes determined by a point in space and the global location of the element center, to define the a-direction.</p> <p>EQ.2.0: globally orthotropic with material axes determined by vectors defined below, as with *DEFINE_COORDINATE_VECTOR.</p> <p>EQ.3.0: locally orthotropic material axes determined by rotating the material axes about the element normal by an angle, BETA, from a line in the plane of the element defined by the cross product of the vector v with the element normal. The plane of a solid element is the midsurface between the inner surface and outer surface defined by the first four nodes and the last four nodes of the connectivity of the element, respectively.</p> <p>EQ.4.0: locally orthotropic in cylindrical coordinate system with the material axes determined by a vector v, and an originating point, P, which define the centerline axis. This option is for solid elements only.</p> <p>LT.0.0: the absolute value of AOPT is a coordinate system ID number (CID on *DEFINE_COORDINATE_NODES, *DEFINE_COORDINATE_SYSTEM or *DEFINE_COORDINATE_VECTOR). Available in R3 version of 971 and later.</p>
MACF	<p>Material axes change flag:</p> <p>EQ.1: No change, default,</p> <p>EQ.2: switch material axes a and b,</p> <p>EQ.3: switch material axes a and c,</p> <p>EQ.4: switch material axes b and c.</p>
XP YP ZP	Define coordinates of point <b>p</b> for AOPT = 1.
A1 A2 A3	Define components of vector <b>a</b> for AOPT = 2.
V1 V2 V3	Define components of vector <b>v</b> for AOPT = 3.
D1 D2 D3	Define components of vector <b>d</b> for AOPT = 2.
BETA	Layer in-plane rotational angle in degrees.
SAT	Longitudinal tensile strength
SAC	Longitudinal compressive strength

<u>VARIABLE</u>	<u>DESCRIPTION</u>
SBT	Transverse tensile strength
SBC	Transverse compressive strength
SCT	Through thickness tensile strength
SFC	Crush strength
SFS	Fiber mode shear strength
SAB	Matrix mode shear strength, ab plane, see below.
SBC	Matrix mode shear strength, bc plane, see below.
SCA	Matrix mode shear strength, ca plane, see below.
SFFC	Scale factor for residual compressive strength
AMODEL	Material models: EQ.1: Unidirectional layer model EQ.2: Fabric layer model
PHIC	Coulomb friction angle for matrix and delamination failure, <90
E_LIMT	Element eroding axial strain
S_DELM	Scale factor for delamination criterion
OMGMX	Limit damage parameter for elastic modulus reduction
ECRSH	Limit compressive volume strain for element eroding
EEXPAN	Limit tensile volume strain for element eroding
CERATE1	Coefficient for strain rate dependent strength properties
AM1	Coefficient for strain rate softening property for fiber damage in a direction.
AM2	Coefficient for strain rate softening property for fiber damage in b direction.
AM3	Coefficient for strain rate softening property for fiber crush and punch shear damage.
AM4	Coefficient for strain rate softening property for matrix and delamination damage.

VARIABLE	DESCRIPTION
CERATE2	Coefficient for strain rate dependent axial moduli.
CERATE3	Coefficient for strain rate dependent shear moduli.
CERATE4	Coefficient for strain rate dependent transverse moduli.

**Material Models:**

The unidirectional and fabric layer failure criteria and the associated property degradation models for material 161 are described as follows. All the failure criteria are expressed in terms of stress components based on ply level stresses ( $\sigma_a, \sigma_b, \sigma_c, \tau_{ab}, \tau_{bc}, \tau_{ca}$ ) and the associated elastic moduli are ( $E_a, E_b, E_c, G_{ab}, G_{bc}, G_{ca}$ ). Note that for the unidirectional model, a, b and c denote the fiber, in-plane transverse and out-of-plane directions, respectively, while for the fabric model, a, b and c denote the in-plane fill, in-plane warp and out-of-plane directions, respectively.

**Unidirectional lamina model**

Three criteria are used for fiber failure, one in tension/shear, one in compression and another one in crush under pressure. They are chosen in terms of quadratic stress forms as follows:

Tensile/shear fiber mode:

$$f_1 = \left( \frac{\langle \sigma_a \rangle}{S_{aT}} \right)^2 + \left( \frac{\tau_{ab}^2 + \tau_{ca}^2}{S_{FS}^2} \right) - 1 = 0$$

Compression fiber mode:

$$f_2 = \left( \frac{\langle \sigma'_a \rangle}{S_{aC}} \right)^2 - 1 = 0, \quad \sigma'_a = -\sigma_a + \left\langle -\frac{\sigma_b + \sigma_c}{2} \right\rangle$$

Crush mode:

$$f_3 = \left( \frac{\langle p \rangle}{S_{FC}} \right)^2 - 1 = 0, \quad p = -\frac{\sigma_a + \sigma_b + \sigma_c}{3}$$

where  $\langle \rangle$  are Macaulay brackets,  $S_{aT}$  and  $S_{aC}$  are the tensile and compressive strengths in the fiber direction, and  $S_{FS}$  and  $S_{FC}$  are the layer strengths associated with the fiber shear and crush failure, respectively.

Matrix mode failures must occur without fiber failure, and hence they will be on planes parallel to fibers. For simplicity, only two failure planes are considered: one is perpendicular to the planes of layering and the other one is parallel to them. The matrix failure criteria for the failure plane perpendicular and parallel to the layering planes, respectively, have the forms:

Perpendicular matrix mode:

$$f_4 = \left( \frac{\langle \sigma_b \rangle}{S_{bT}} \right)^2 + \left( \frac{\tau_{bc}}{S'_{bc}} \right)^2 + \left( \frac{\tau_{ab}}{S_{ab}} \right)^2 - 1 = 0$$

Parallel matrix mode (Delamination):

$$f_5 = S^2 \left\{ \left( \frac{\langle \sigma_c \rangle}{S_{bT}} \right)^2 + \left( \frac{\tau_{bc}}{S'_{bc}} \right)^2 + \left( \frac{\tau_{ca}}{S_{ca}} \right)^2 \right\} - 1 = 0$$

where  $S_{bT}$  is the transverse tensile strength. Based on the Coulomb-Mohr theory, the shear strengths for the transverse shear failure and the two axial shear failure modes are assumed to be the forms,

$$S_{ab} = S_{ab}^{(0)} + \tan(\varphi) \langle -\sigma_b \rangle$$

$$S'_{bc} = S'_{bc}^{(0)} + \tan(\varphi) \langle -\sigma_b \rangle$$

$$S_{ca} = S_{ca}^{(0)} + \tan(\varphi) \langle -\sigma_c \rangle$$

$$S'_{bc} = S'_{bc}^{(0)} + \tan(\varphi) \langle -\sigma_c \rangle$$

where  $\varphi$  is a material constant as  $\tan(\varphi)$  is similar to the coefficient of friction, and  $S_{ab}^{(0)}$ ,  $S_{ca}^{(0)}$  and  $S'_{bc}^{(0)}$  are the shear strength values of the corresponding tensile modes.

Failure predicted by the criterion of  $f_4$  can be referred to as transverse matrix failure, while the matrix failure predicted by  $f_5$ , which is parallel to the layer, can be referred as the delamination mode when it occurs within the elements that are adjacent to the ply interface. Note that a scale factor  $S$  is introduced to provide better correlation of delamination area with experiments. The scale factor  $S$  can be determined by fitting the analytical prediction to experimental data for the delamination area.

When fiber failure in tension/shear mode is predicted in a layer by  $f_1$ , the load carrying capacity of that layer is completely eliminated. All the stress components are reduced to zero instantaneously (100 time steps to avoid numerical instability). For compressive fiber failure, the layer is assumed to carry a residual axial load, while the transverse load carrying capacity is reduced to zero. When the fiber compressive failure mode is reached due to  $f_2$ , the axial layer compressive strength stress is assumed to reduce to a residual value  $S_{RC}$  ( $= SFFC * S_{AC}$ ). The axial stress is then assumed to remain constant, i.e.,  $\sigma_a = -S_{RC}$ , for continuous compressive loading, while the subsequent unloading curve follows a reduced axial modulus to zero axial stress and strain state. When the fiber crush failure occurs, the material is assumed to behave elastically for compressive pressure,  $p > 0$ , and to carry no load for tensile pressure,  $p < 0$ .

When a matrix failure (delamination) in the a-b plane is predicted, the strength values for  $S_{ca}^{(0)}$  and  $S_{bc}^{(0)}$  are set to zero. This results in reducing the stress components  $\sigma_c$ ,  $\tau_{bc}$  and  $\tau_{ca}$  to the fractured material strength surface. For tensile mode,  $\sigma_c > 0$ , these stress components are reduced to zero. For compressive mode,  $\sigma_c < 0$ , the normal stress  $\sigma_c$  is assumed to deform elastically for the closed matrix crack. Loading on the failure envelop, the shear stresses are assumed to ‘slide’ on the fractured strength surface (frictional shear stresses) like in an ideal plastic material, while the subsequent unloading shear stress-strain path follows reduced shear moduli to the zero shear stress and strain state for both  $\tau_{bc}$  and  $\tau_{ca}$  components.

The post failure behavior for the matrix crack in the a-c plane due to f4 is modeled in the same fashion as that in the a-b plane as described above. In this case, when failure occurs,  $S_{ab}^{(0)}$  and  $S_{bc}^{(0)}$  are reduced to zero instantaneously. The post fracture response is then governed by failure criterion of f5 with  $S_{ab}^{(0)} = 0$  and  $S_{bc}^{(0)} = 0$ . For tensile mode,  $\sigma_b > 0$ ,  $\sigma_b$ ,  $\tau_{ab}$  and  $\tau_{bc}$  are zero. For compressive mode,  $\sigma_b < 0$ ,  $\sigma_b$  is assumed to be elastic, while  $\tau_{ab}$  and  $\tau_{bc}$  ‘slide’ on the fracture strength surface as in an ideal plastic material, and the unloading path follows reduced shear moduli to the zero shear stress and strain state. It should be noted that  $\tau_{bc}$  is governed by both the failure functions and should lie within or on each of these two strength surfaces.

#### Fabric lamina model

The fiber failure criteria of Hashin for a unidirectional layer are generalized to characterize the fiber damage in terms of strain components for a plain weave layer. The fill and warp fiber tensile/shear failure are given by the quadratic interaction between the associated axial and shear stresses, i.e.

$$f_6 = \left( \frac{\langle \sigma_a \rangle}{S_{aT}} \right)^2 + \frac{(\tau_{ab}^2 + \tau_{ca}^2)}{S_{aFS}^2} - 1 = 0$$

$$f_7 = \left( \frac{\langle \sigma_b \rangle}{S_{bT}} \right)^2 + \frac{(\tau_{ab}^2 + \tau_{bc}^2)}{S_{bFS}^2} - 1 = 0$$

where  $S_{aT}$  and  $S_{bT}$  are the axial tensile strengths in the fill and warp directions, respectively, and  $S_{aFS}$  and  $S_{bFS}$  are the layer shear strengths due to fiber shear failure in the fill and warp directions. These failure criteria are applicable when the associated  $\sigma_a$  or  $\sigma_b$  is positive. It is assumed  $S_{aFS} = SFS$ , and

$$S_{bFS} = SFS * S_{bT} / S_{aT}.$$

When  $\sigma_a$  or  $\sigma_b$  is compressive, it is assumed that the in-plane compressive failure in both the fill and warp directions are given by the maximum stress criterion, i.e.

$$f_8 = \left[ \frac{\langle \sigma'_a \rangle}{S_{aC}} \right]^2 - 1 = 0, \quad \sigma'_a = -\sigma_a + \langle -\sigma_c \rangle$$



$$f_9 = \left[ \frac{\langle \sigma'_b \rangle}{S_{bC}} \right]^2 - 1 = 0, \quad \sigma'_b = -\sigma_b + \langle -\sigma_c \rangle$$

where  $S_{aC}$  and  $S_{bC}$  are the axial compressive strengths in the fill and warp directions, respectively. The crush failure under compressive pressure is

$$f_{10} = \left( \frac{\langle p \rangle}{S_{FC}} \right)^2 - 1 = 0, \quad p = -\frac{\sigma_a + \sigma_b + \sigma_c}{3}$$

A plain weave layer can fail under in-plane shear stress without the occurrence of fiber breakage. This in-plane matrix failure mode is given by

$$f_{11} = \left( \frac{\tau_{ab}}{S_{ab}} \right)^2 - 1 = 0$$

where  $S_{ab}$  is the layer shear strength due to matrix shear failure.

Another failure mode, which is due to the quadratic interaction between the thickness stresses, is expected to be mainly a matrix failure. This through the thickness matrix failure criterion is

$$f_{12} = S^2 \left\{ \left( \frac{\langle \sigma_c \rangle}{S_{cT}} \right)^2 + \left( \frac{\tau_{bc}}{S_{bc}} \right)^2 + \left( \frac{\tau_{ca}}{S_{ca}} \right)^2 \right\} - 1 = 0$$

where  $S_{cT}$  is the through the thickness tensile strength, and  $S_{bc}$ , and  $S_{ca}$  are the shear strengths assumed to depend on the compressive normal stress  $\sigma_c$ , i.e.,

$$\begin{Bmatrix} S_{ca} \\ S_{bc} \end{Bmatrix} = \begin{Bmatrix} S_{ca}^{(0)} \\ S_{bc}^{(0)} \end{Bmatrix} + \tan(\varphi) \langle -\sigma_c \rangle$$

When failure predicted by this criterion occurs within elements that are adjacent to the ply interface, the failure plane is expected to be parallel to the layering planes, and, thus, can be referred to as the delamination mode. Note that a scale factor  $S$  is introduced to provide better correlation of delamination area with experiments. The scale factor  $S$  can be determined by fitting the analytical prediction to experimental data for the delamination area.

Similar to the unidirectional model, when fiber tensile/shear failure is predicted in a layer by  $f_6$  or  $f_7$ , the load carrying capacity of that layer in the associated direction is completely eliminated. For compressive fiber failure due to by  $f_8$  or  $f_9$ , the layer is assumed to carry a residual axial load in the failed direction, while the load carrying capacity transverse to the failed direction is assumed unchanged. When the compressive axial stress in a layer reaches the compressive axial strength  $S_{aC}$  or  $S_{bC}$ , the axial layer stress is assumed to be reduced to the residual strength  $S_{aRC}$  or  $S_{bRC}$  where  $S_{aRC} = SFFC * S_{aC}$  and  $S_{bRC} = SFFC * S_{bC}$ . The axial stress is assumed to remain

constant, i.e.,  $\sigma_a = -S_{aCR}$  or  $\sigma_b = -S_{bCR}$ , for continuous compressive loading, while the subsequent unloading curve follows a reduced axial modulus. When the fiber crush failure is occurred, the material is assumed to behave elastically for compressive pressure,  $p > 0$ , and to carry no load for tensile pressure,  $p < 0$ .

When the in-plane matrix shear failure is predicted by f11 the axial load carrying capacity within a failed element is assumed unchanged, while the in-plane shear stress is assumed to be reduced to zero.

For through the thickness matrix (delamination) failure given by equations f12, the in-plane load carrying capacity within the element is assumed to be elastic, while the strength values for the tensile mode,  $S_{ca}^{(0)}$  and  $S_{bc}^{(0)}$ , are set to zero. For tensile mode,  $\sigma_c > 0$ , the through the thickness stress components are reduced to zero. For compressive mode,  $\sigma_c < 0$ ,  $\sigma_c$  is assumed to be elastic, while  $\tau_{bc}$  and  $\tau_{ca}$  'slide' on the fracture strength surface as in an ideal plastic material, and the unloading path follows reduced shear moduli to the zero shear stress and strain state.

The effect of strain-rate on the layer strength values of the fiber failure modes is modeled by the strain-rate dependent functions for the strength values  $\{S_{RT}\}$  as

$$\{S_{RT}\} = \{S_0\} \left( 1 + C_{rate1} \ln \frac{\{\dot{\epsilon}\}}{\dot{\epsilon}_0} \right)$$

$$\{S_{RT}\} = \begin{Bmatrix} S_{aT} \\ S_{aC} \\ S_{bT} \\ S_{bC} \\ S_{FC} \\ S_{FS} \end{Bmatrix} \text{ and } \{\dot{\epsilon}\} = \begin{Bmatrix} |\dot{\epsilon}_a| \\ |\dot{\epsilon}_a| \\ |\dot{\epsilon}_b| \\ |\dot{\epsilon}_b| \\ |\dot{\epsilon}_c| \\ (\dot{\epsilon}_{ca}^2 + \dot{\epsilon}_{bc}^2)^{1/2} \end{Bmatrix}$$

where  $C_{rate}$  is the strain-rate constants, and  $\{S_0\}$  are the strength values of  $\{S_{RT}\}$  at the reference strain-rate  $\dot{\epsilon}_0$ .

**Damage model**

The damage model is a generalization of the layer failure model of Material 161 by adopting the MLT damage mechanics approach, Matzenmiller et al. [1995], for characterizing the softening behavior after damage initiation. Complete model description is given in Yen [2002]. The damage functions, which are expressed in terms of ply level engineering strains, are converted from the above failure criteria of fiber and matrix failure modes by neglecting the Poisson's effect. Elastic moduli reduction is expressed in terms of the associated damage parameters  $\varpi_i$ :

$$E'_i = (1 - \varpi_i) E_i$$

$$\varpi_i = 1 - \exp(-r_i^{m_i} / m_i) \quad r_i \geq 0 \quad i = 1, \dots, 6$$

where  $E_i$  are the initial elastic moduli,  $E'_i$  are the reduced elastic moduli,  $r_i$  are the damage thresholds computed from the associated damage functions for fiber damage, matrix damage and delamination, and  $m_i$  are material damage parameters, which are currently assumed to be independent of strain-rate. The damage function is formulated to account for the overall nonlinear elastic response of a lamina including the initial ‘hardening’ and the subsequent softening beyond the ultimate strengths.

In the damage model (material 162), the effect of strain-rate on the nonlinear stress-strain response of a composite layer is modeled by the strain-rate dependent functions for the elastic moduli  $\{E_{RT}\}$  as

$$\{E_{RT}\} = \{E_0\} \left( 1 + \{C_{rate}\} \ln \frac{\{\dot{\epsilon}\}}{\dot{\epsilon}_0} \right)$$

$$\{E_{RT}\} = \begin{Bmatrix} E_a \\ E_b \\ E_c \\ G_{ab} \\ G_{bc} \\ G_{ca} \end{Bmatrix}, \quad \{\dot{\epsilon}\} = \begin{Bmatrix} \dot{\epsilon}_a \\ \dot{\epsilon}_b \\ \dot{\epsilon}_c \\ \dot{\epsilon}_{ab} \\ \dot{\epsilon}_{bc} \\ \dot{\epsilon}_{ca} \end{Bmatrix} \quad \text{and} \quad \{C_{rate}\} = \begin{Bmatrix} C_{rate2} \\ C_{rate2} \\ C_{rate4} \\ C_{rate3} \\ C_{rate3} \\ C_{rate3} \end{Bmatrix}$$

where  $\{C_{rate}\}$  are the strain-rate constants.  $\{E_0\}$  are the modulus values of  $\{E_{RT}\}$  at the reference strain-rate  $\dot{\epsilon}_0$ .

**Element Erosion:**

A failed element is eroded in any of three different ways:

1. If fiber tensile failure in a unidirectional layer is predicted in the element and the axial tensile strain is greater than E\_LIMT. For a fabric layer, both in-plane directions are failed and exceed E\_LIMT.
2. If compressive relative volume in a failed element is smaller than ECRSH.
3. If tensile relative volume in a failed element is greater than EEXPN.

**Damage History Parameters:**

Information about the damage history variables for the associated failure modes can be plotted in LS-PrePost. These additional history variables are tabulated below:

History Variable	Description	Value	LS-PrePost History Variable
1. efa(I)	Fiber mode in a		7
2. efb(I)	Fiber mode in b	0-elastic	8
3. efp(I)	Fiber crush mode		9

History Variable	Description	Value	LS-PrePost History Variable
4. em(I)	Perpendicular matrix mode	$\geq 1$ -failed	10
5. ed(I)	Parallel matrix/delamination mode		11
6. delm(I)	delamination mode		12

**\*MAT\_MODIFIED\_CRUSHABLE\_FOAM**

This is Material Type 163 which is dedicated to modeling crushable foam with optional damping, tension cutoff, and strain rate effects. Unloading is fully elastic. Tension is treated as elastic-perfectly-plastic at the tension cut-off value.

Card 1            1            2            3            4            5            6            7            8

Variable	MID	RO	E	PR	TID	TSC	DAMP	NCYCLE
Type	A8	F	F	F	F	F	F	F
Default	none	none	none	none	none	0.0	0.10	12.

Card 2            1            2            3            4            5            6            7            8

Variable	SRCLMT	SFLAG						
Type	F	I						
Default	1.E+20	0						

<u>VARIABLE</u>	<u>DESCRIPTION</u>
MID	Material identification. A unique number or label not exceeding 8 characters must be specified.
RO	Mass density
E	Young's modulus
PR	Poisson's ratio
TID	Table ID defining yield stress versus volumetric strain, $\gamma$ , at different strain rates.
TSC	Tensile stress cutoff. A nonzero, positive value is strongly recommended for realistic behavior.
DAMP	Rate sensitivity via damping coefficient ( $.05 < \text{recommended value} < .50$ ).

---

<u>VARIABLE</u>	<u>DESCRIPTION</u>
NCYCLE	Number of cycles to determine the average volumetric strain rate.
SRCLMT	Strain rate change limit.
SFLAG	The strain rate in the table may be the true strain rate (SFLAG=0) or the engineering strain rate (SFLAG=1).

**Remarks:**

The volumetric strain is defined in terms of the relative volume, V, as:

$$\gamma = 1.-V$$

The relative volume is defined as the ratio of the current to the initial volume. In place of the effective plastic strain in the D3PLOT database, the integrated volumetric strain is output.

This material is an extension of material 63, \*MAT\_CRUSHABLE\_FOAM. It allows the yield stress to be a function of both volumetric strain rate and volumetric strain. Rate effects are accounted for by defining a table of curves using \*DEFINE\_TABLE. Each curve defines the yield stress versus volumetric strain for a different strain rate. The yield stress is obtained by interpolating between the two curves that bound the strain rate.

To prevent high frequency oscillations in the strain rate from causing similar high frequency oscillations in the yield stress, a modified volumetric strain rate is used when interpolating to obtain the yield stress. The modified strain rate is obtained as follows. If NCYCLE is >1, then the modified strain rate is obtained by a time average of the actual strain rate over NCYCLE solution cycles. For SRCLMT>0, the modified strain rate is capped so that during each cycle, the modified strain rate is not permitted to change more than SRCLMT multiplied by the solution time step.

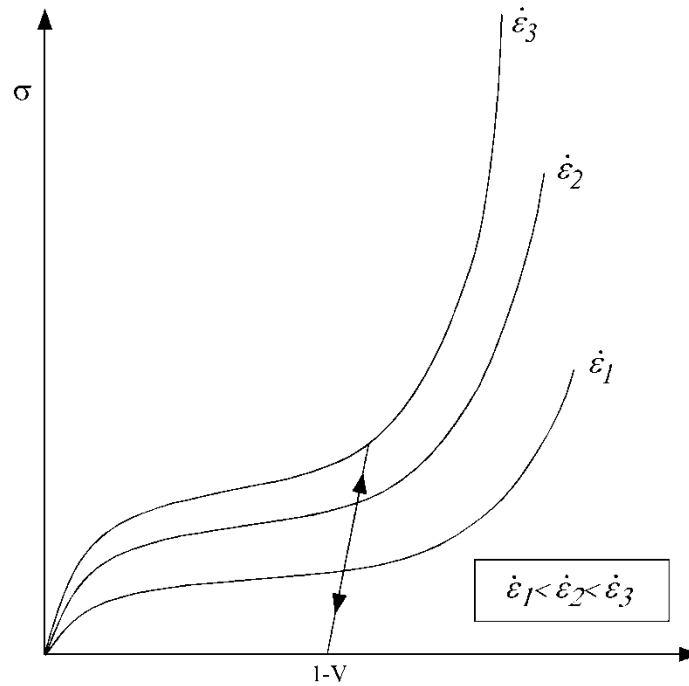

**Figure 163.1.** Rate effects are defined by a family of curves giving yield stress versus volumetric strain where  $V$  is the relative volume.

**\*MAT\_BRAIN\_LINEAR\_VISCOELASTIC**

This is Material Type 164. This material is a Kelvin-Maxwell model for modeling brain tissue, which is valid for solid elements only. See Remarks below.

Card 1            1            2            3            4            5            6            7            8

Variable	MID	RO	BULK	G0	GI	DC	FO	SO
Type	A8	F	F	F	F	F	F	F
Default	none	none	none	none	none	0.0	0.0	0.0

<b>VARIABLE</b>	<b>DESCRIPTION</b>
MID	Material identification. A unique number or label not exceeding 8 characters must be specified.
RO	Mass density
BULK	Bulk modulus (elastic)
G0	Short-time shear modulus, $G_0$
GI	Long-time (infinite) shear modulus, $G_\infty$
DC	Maxwell decay constant, $\beta$ [FO=0.0] or Kelvin relaxation constant, $\tau$ [FO=1.0]
FO	Formulation option: EQ.0.0: Maxwell, EQ.1.0: Kelvin.
SO	Strain (logarithmic) output option to control what is written as component 7 to the d3plot database. (LS-Prepost always blindly labels this component as effective plastic strain.) The maximum values are updated for each element each time step: EQ.0.0: maximum principal strain that occurs during the calculation, EQ.1.0: maximum magnitude of the principal strain values that occurs during the calculation, EQ.2.0: maximum effective strain that occurs during the calculation.



**Remarks:**

The shear relaxation behavior is described for the Maxwell model by:

$$G(t) = G + (G_0 - G_\infty)e^{-\beta t}$$

A Jaumann rate formulation is used

$$\overset{\nabla}{\sigma}'_{ij} = 2 \int_0^t G(t-\tau) D'_{ij}(\tau) dt$$

where the prime denotes the deviatoric part of the stress rate,  $\overset{\nabla}{\sigma}'_{ij}$ , and the strain rate  $D_{ij}$ . For the Kelvin model the stress evolution equation is defined as:

$$\dot{s}_{ij} + \frac{1}{\tau} s_{ij} = (1 + \delta_{ij}) G_0 \dot{\epsilon}_{ij} + (1 + \delta_{ij}) \frac{G_\infty}{\tau} \dot{\epsilon}_{ij}$$

The strain data as written to the d3plot database may be used to predict damage, see [Bandak 1991].

**\*MAT\_PLASTIC\_NONLINEAR\_KINEMATIC**

This is Material Type 165. This relatively simple model, based on a material model by Lemaitre and Chaboche [1990], is suited to model nonlinear kinematic hardening plasticity. The model accounts for the nonlinear Bauschinger effect, cyclic hardening, and ratcheting. Huang [2006] programmed this model and provided it as a user subroutine. It is a very cost effective model and is available shell and solid elements. This material model is available starting with the R3 release of Version 971.

Card 1            1            2            3            4            5            6            7            8

Variable	MID	RO	E	PR	SIGY	H	C	GAMMA
Type	A8	F	F	F	F	F	F	F
Default	none	none	none	none	none	0.0	0.0	0.0

Card 2            1            2            3            4            5            6            7            8

Variable	FS							
Type	F							
Default	1.E+16							

<u>VARIABLE</u>	<u>DESCRIPTION</u>
MID	Material identification. A unique number or label not exceeding 8 characters must be specified.
RO	Mass density.
E	Young's modulus.
PR	Poisson's ratio.
SIGY	Initial yield stress, $\sigma_{y0}$ .
H	Isotropic plastic hardening modulus
C	Kinematic hardening modulus

---

<u>VARIABLE</u>	<u>DESCRIPTION</u>
GAMMA	Kinematic hardening parameter, $\gamma$ .
FS	Failure strain for eroding elements.

**Remarks:**

If the isotropic hardening modulus,  $H$ , is nonzero, the size of the surface increases as function of the equivalent plastic strain,  $\varepsilon^p$ :

$$\sigma_y = \sigma_{y0} + H\varepsilon^p$$

The rate of evolution of the kinematic component is a function of the plastic strain rate:

$$\dot{\alpha} = [Cn - \gamma\alpha]\dot{\varepsilon}^p$$

where,  $n$ , is the flow direction. The term,  $\gamma\alpha\dot{\varepsilon}^p$ , introduces the nonlinearity into the evolution law, which becomes linear if the parameter,  $\gamma$ , is set to zero.

**\*MAT\_MOMENT\_CURVATURE\_BEAM**

This is Material Type 166. This material is for performing nonlinear elastic or multi-linear plastic analysis of Belytschko-Schwer beams with user-defined axial force-strain, moment curvature and torque-twist rate curves. If strain, curvature or twist rate is located outside the curves, use extrapolation to determine the corresponding rigidity. For multi-linear plastic analysis, the user-defined curves are used as yield surfaces.

Card 1            1            2            3            4            5            6            7            8

Variable	MID	RO	E	ELAF	EPFLG	CTA	CTB	CTT
Type	A8	F	F	F	F	F	F	F
Default	none	none	none	none	0.0	0.0	0.0	0.0

Card 2            1            2            3            4            5            6            7            8

Variable	N1	N2	N3	N4	N5	N6	N7	N8
Type	F	F	F	F	F	F	F	F
Default	none	none	0.0/none	0.0	0.0	0.0	0.0	0.0

Card 3            1            2            3            4            5            6            7            8

Variable	LCMS1	LCMS2	LCMS3	LCMS4	LCMS5	LCMS6	LCMS7	LCMS8
Type	F	F	F	F	F	F	F	F
Default	none	none	0.0/none	0.0	0.0	0.0	0.0	0.0

Card 4            1            2            3            4            5            6            7            8

Variable	LCMT1	LCMT2	LCMT3	LCMT4	LCMT5	LCMT6	LCMT7	LCMT8
Type	F	F	F	F	F	F	F	F
Default	none	none	0.0/none	0.0	0.0	0.0	0.0	0.0

Card 5            1            2            3            4            5            6            7            8

Variable	LCT1	LCT2	LCT3	LCT4	LCT5	LCT6	LCT7	LCT8
Type	F	F	F	F	F	F	F	F
Default	none	none	0.0/none	0.0	0.0	0.0	0.0	0.0

**Card 6 is for multi-linear plastic analysis only.**

Card 6            1            2            3            4            5            6            7            8

Variable	CFA	CFB	CFT	HRULE	REPS	RBETA	RCAPAY	RCAPAZ
Type	F	F	F	F	F	F	F	F
Default	1.0	1.0	1.0	0.0	1.0E+20	1.0E+20	1.0E+20	1.0E+20

**VARIABLE**

**DESCRIPTION**

- MID            Material identification. A unique number or label not exceeding 8 characters must be specified.
- RO            Mass density
- E            Young's modulus. This variable controls the time step size and must be chosen carefully. Increasing the value of E will decrease the time step size.
- ELAF            Load curve ID for the axial force-strain curve

VARIABLE	DESCRIPTION
EPFLG	Function flag EQ.0.0: nonlinear elastic analysis EQ.1.0: multi-linear plastic analysis
CTA, CTB, CTT	Type of axial force-strain, moment-curvature, and torque-twist rate curves EQ.0.0: curve is symmetric EQ.1.0: curve is asymmetric  For symmetric curves, all data point must be in the first quadrant and at least three data points need to be given, starting from the origin, ensued by the yield point.  For asymmetric curves, at least five data points are needed and exactly one point must be at the origin. The two points on both sides of the origin record the positive and negative yield points.  The last data point(s) has no physical meaning: it serves only as a control point for inter or extrapolation.  The curves are input by the user and treated in LS-DYNA as a linearly piecewise function. The curves must be monotonically increasing, while the slopes must be monotonically decreasing
N1-N8	Axial forces at which moment-curvature curves are given. The axial forces must be ordered monotonically increasing. At least two axial forces must be defined if the curves are symmetric. At least three axial forces must be defined if the curves are asymmetric.
LCMS1-LCMS8	Load curve IDs for the moment-curvature curves about axis S under corresponding axial forces.
LCMT1-LCMT8	Load curve IDs for the moment-curvature curves about axis T under corresponding axial forces.
LCT1-LCT8	Load curve IDs for the torque-twist rate curves under corresponding axial forces.
CFA, CFB, CFT	For multi-linear plastic analysis only. Ratio of axial, bending and torsional elastic rigidities to their initial values, no less than 1.0 in value.
HRULE	Hardening rule, for multi-linear plastic analysis only. EQ.0.0: isotropic hardening EQ.1.0: kinematic hardening In between: mixed hardening
REPS	Rupture effective plastic axial strain
RBETA	Rupture effective plastic twist rate

---

<u>VARIABLE</u>	<u>DESCRIPTION</u>
RCAPAY	Rupture effective plastic curvature about axis S
RCAPAZ	Rupture effective plastic curvature about axis T



**\*MAT\_MCCORMICK**

This is Material Type 167. This is a constitute model for finite plastic deformities in which the material's strength is defined by McCormick's constitutive relation for materials exhibiting negative steady-state Strain Rate Sensitivity (SRS). McCormick [1988] and Zhang, McCormick and Estrin [2001].

Card 1            1            2            3            4            5            6            7            8

Variable	MID	RO	E	PR	SIGY			
Type	A8	F	F	F	F			

Card 2            1            2            3            4            5            6            7            8

Variable	Q1	C1	Q2	C2				
Type	F	F	F	F				

Card 3            1            2            3            4            5            6            7            8

Variable	S	H	OMEGA	TD	ALPHA	EPS0		
Type	F	F	F	F	F	F		

<u>VARIABLE</u>	<u>DESCRIPTION</u>
MID	Material identification. A unique number or label not exceeding 8 characters must be specified.
RO	Mass density.
E	Young's modulus.
PR	Poisson's ratio.
SIGY	Initial yield stress
Q1	Isotropic hardening parameter, $Q_1$



<u>VARIABLE</u>	<u>DESCRIPTION</u>
C1	Isotropic hardening parameter, $C_1$
Q2	Isotropic hardening parameter, $Q_2$
C2	Isotropic hardening parameter, $C_2$
S	Dynamic strain aging parameter, $S$
H	Dynamic strain aging parameter, $H$
OMEGA	Dynamic strain aging parameter, $\Omega$
TD	Dynamic strain aging parameter, $t_d$
ALPHA	Dynamic strain aging parameter, $\alpha$
EPS0	Reference strain rate, $\dot{\epsilon}_0$

**Remarks:**

The uniaxial stress-strain curve is given in the following form:

$$\sigma(\epsilon^p, \dot{\epsilon}^p) = \sigma_Y(t_a) + R(\epsilon^p) + \sigma_v(\dot{\epsilon}^p)$$

Viscous stress  $\sigma_v$  is given by

$$\sigma_v(\dot{\epsilon}^p) = S \ln \left( 1 + \frac{\dot{\epsilon}^p}{\dot{\epsilon}_0} \right)$$

where  $S$  represents the instantaneous strain rate sensitivity and  $\dot{\epsilon}_0$  is a reference strain rate.

In the McCormick model the yield strength including the contribution from dynamic strain aging (DSA) is defined as

$$\sigma_Y(t_a) = \sigma_o + SH \left[ 1 - \exp \left\{ - \left( \frac{t_a}{t_d} \right)^\alpha \right\} \right]$$

where  $\sigma_o$  is the yield strength for vanishing average waiting time  $t_a$ , and  $H$ ,  $\alpha$ , and  $t_d$  are material constants linked to dynamic strain aging.

The average waiting time is defined by the evolution equation

$$\dot{t}_a = 1 - \frac{t_a}{t_{a,ss}}$$

where the quasi-steady state waiting time  $t_{a,ss}$  is given as

$$t_{a,ss} = \frac{\Omega}{\dot{\varepsilon}^p}.$$

The strain hardening function  $R$  is defined by the extended Voce Law

$$R(\varepsilon^p) = Q_1 [1 - \exp(-C_1 \varepsilon^p)] + Q_2 [1 - \exp(-C_2 \varepsilon^p)].$$

## \*MAT\_POLYMER

This is material type 168. This model is implemented for brick elements.

Card 1            1            2            3            4            5            6            7            8

Variable	MID	RO	E	PR	GAMMA0	DG	SC	ST
Type	A8	F	F	F	F	F	F	F

Card 2            1            2            3            4            5            6            7            8

Variable	TEMP	K	CR	N	C			
Type	F	F	F	F	F			

**VARIABLE****DESCRIPTION**

MID	Material identification. A unique number or label not exceeding 8 characters must be specified.
RO	Mass Density.
E	Young's modulus, $E$ .
PR	Poisson's ratio, $\nu$ .
GAMMA0	Pre-exponential factor, $\dot{\gamma}_{0A}$ .
DG	Energy barrier to flow, $\Delta G$ .
SC	Shear resistance in compression, $S_c$ .
ST	Shear resistance in tension, $S_t$ .
TEMP	Absolute temperature, $\theta$ .
K	Boltzmann constant, $k$ .
CR	Product, $C_r = nk\theta$ .
N	Number of 'rigid links' between entanglements, $N$ .

VARIABLE	DESCRIPTION
C	Relaxation factor, C .

**Remarks:**

The polymer is assumed to have two basic resistances to deformation:

1. An inter-molecular barrier to deformation related to relative movement between molecules.
2. An evolving anisotropic resistance related to straightening of the molecule chains.

The model which is implemented and presented in this paper is mainly based on the framework suggested by Boyce et al. [2000]. Going back to the original work by Haward and Thackray [1968], they considered the uniaxial case only. The extension to a full 3D formulation was proposed by Boyce et al. [1988]. Moreover, Boyce and co-workers have during a period of 20 years changed or further developed the parts of the original model. Haward and Thackray [1968] used an Eyring model to represent the dashpot in Fig. 168.1, while Boyce et al. [2000] employed the double-kink model of Argon [1973] instead. Part B of the model, describing the resistance associated with straightening of the molecules, contained originally a one-dimensional Langevin spring [Haward and Thackray, 1968], which was generalized to 3D with the eight-chain model by Arruda and Boyce [1993].

The main structure of the model presented by Boyce et al. [2000] is kept for this model. Recognizing the large elastic deformations occurring for polymers, a formulation based on a Neo-Hookean material is here selected for describing the spring in resistance A in Figure 168.1.

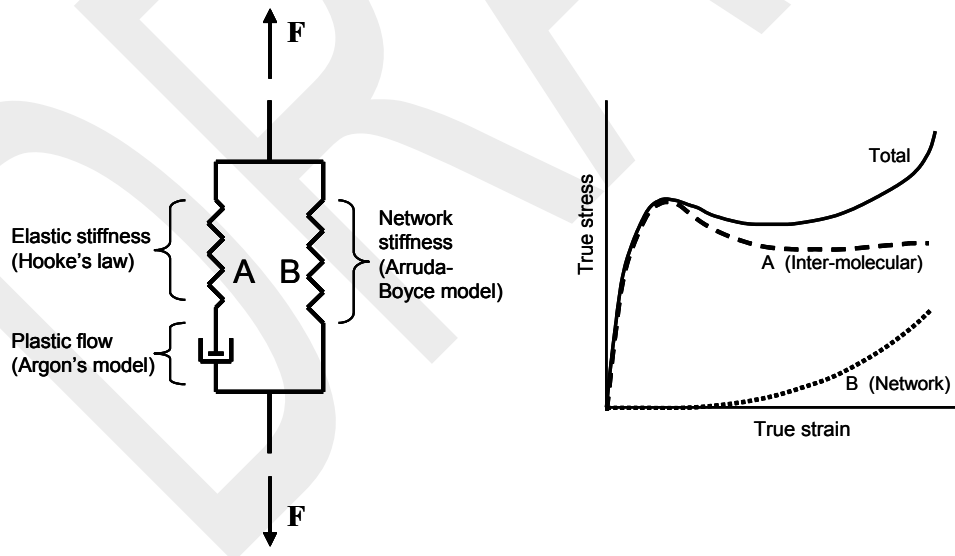

**Figure 168.1.** Stress decomposition in inter-molecular and network contributions.

Referring to Fig. 1, it is assumed that the deformation gradient tensor is the same for the two resistances (Part A and B)

$$\mathbf{F} = \mathbf{F}_A = \mathbf{F}_B$$

while the Cauchy stress tensor for the system is assumed to be the sum of the Cauchy stress tensors for the two parts

$$\boldsymbol{\sigma} = \boldsymbol{\sigma}_A + \boldsymbol{\sigma}_B$$

### Part A: Inter-molecular resistance

The deformation is decomposed into elastic and plastic parts,  $\mathbf{F}_A = \mathbf{F}_A^e \cdot \mathbf{F}_A^p$ , where it is assumed that the intermediate configuration  $\bar{\Omega}_A$  defined by  $\mathbf{F}_A^p$  is invariant to rigid body rotations of the current configuration. The velocity gradient in the current configuration  $\Omega$  is defined by

$$\mathbf{L}_A = \dot{\mathbf{F}}_A \cdot \mathbf{F}_A^{-1} = \mathbf{L}_A^e + \mathbf{L}_A^p$$

Owing to the decomposition,  $\mathbf{F}_A = \mathbf{F}_A^e \cdot \mathbf{F}_A^p$ , the elastic and plastic rate-of-deformation and spin tensors are defined by

$$\mathbf{L}_A^e = \mathbf{D}_A^e + \mathbf{W}_A^e = \dot{\mathbf{F}}_A^e \cdot (\mathbf{F}_A^e)^{-1}$$

$$\mathbf{L}_A^p = \mathbf{D}_A^p + \mathbf{W}_A^p = \mathbf{F}_A^e \cdot \dot{\mathbf{F}}_A^p \cdot (\mathbf{F}_A^p)^{-1} \cdot (\mathbf{F}_A^e)^{-1} = \mathbf{F}_A^e \cdot \bar{\mathbf{L}}_A^p \cdot (\mathbf{F}_A^e)^{-1}$$

where  $\bar{\mathbf{L}}_A^p = \dot{\mathbf{F}}_A^p \cdot (\mathbf{F}_A^p)^{-1}$ . The Neo-Hookean material represents an extension of Hooke's law to large elastic deformations and may be chosen for the elastic part of the deformation when the elastic behavior is assumed to be isotropic.

$$\boldsymbol{\tau}_A = \lambda_0 \ln J_A^e \mathbf{I} + \mu_0 (\mathbf{B}_A^e - \mathbf{I})$$

where  $\boldsymbol{\tau}_A = J_A \boldsymbol{\sigma}_A$  is the Kirchhoff stress tensor of Part A and  $J_A^e = \sqrt{\det \mathbf{B}_A^e} = J_A$  is the Jacobian determinant. The elastic left Cauchy-Green deformation tensor is given by  $\mathbf{B}_A^e = \mathbf{F}_A^e \cdot \mathbf{F}_A^{eT}$ .

The flow rule is defined by

$$\mathbf{L}_A^p = \dot{\gamma}_A^p \mathbf{N}_A$$

Where

$$\mathbf{N}_A = \frac{1}{\sqrt{2} \tau_A} \boldsymbol{\tau}_A^{dev}, \quad \tau_A = \sqrt{\frac{1}{2} \text{tr}(\boldsymbol{\tau}_A^{dev})^2}$$

and  $\boldsymbol{\tau}_A^{dev}$  is the stress deviator. The rate of flow is taken to be a thermally activated process

$$\dot{\gamma}_A^p = \dot{\gamma}_{0A} \exp \left[ -\frac{\Delta G(1 - \tau_A / s)}{k\theta} \right]$$

where  $\dot{\gamma}_{0,A}$  is a pre-exponential factor,  $\Delta G$  is the energy barrier to flow,  $s$  is the shear resistance,  $k$  is the Boltzmann constant and  $\theta$  is the absolute temperature. The shear resistance  $s$  is assumed to depend on the stress triaxiality  $\sigma^*$ ,

$$s = s(\sigma^*), \quad \sigma^* = \frac{\text{tr } \boldsymbol{\sigma}_A}{3\sqrt{3}\tau_A}$$

The exact dependence is given by a user-defined load curve, which is linear between the shear resistances in compression and tension. These resistances are denoted  $s_c$  and  $s_t$ , respectively.

### Part B: Network resistance

The network resistance is assumed to be nonlinear elastic with deformation gradient  $\mathbf{F}_B = \mathbf{F}_B^N$ , i.e. any viscoplastic deformation of the network is neglected. The stress-stretch relation is defined by

$$\boldsymbol{\tau}_B = \frac{nk\theta}{3} \frac{\sqrt{N}}{\bar{\lambda}_N} \mathcal{L}^{-1}\left(\frac{\bar{\lambda}_N}{\sqrt{N}}\right) (\bar{\mathbf{B}}_B^N - \bar{\lambda}_N^2 \mathbf{I})$$

where  $\boldsymbol{\tau}_B = J_B \boldsymbol{\sigma}_B$  is the Kirchhoff stress for Part B,  $n$  is the chain density and  $N$  the number of ‘rigid links’ between entanglements. In accordance with Boyce et. al [2000], the product,  $nk\theta$  is denoted  $C_R$  herein. Moreover,  $\mathcal{L}^{-1}$  is the inverse Langevin function,  $\mathcal{L}(\beta) = \coth \beta - 1/\beta$ , and further

$$\bar{\mathbf{B}}_B^N = \bar{\mathbf{F}}_B^N \cdot \bar{\mathbf{F}}_B^{NT}, \quad \bar{\mathbf{F}}_B^N = J_B^{-1/3} \mathbf{F}_B^N, \quad J_B = \det \mathbf{F}_B^N, \quad \bar{\lambda}_N = \left[ \frac{1}{3} \text{tr } \bar{\mathbf{B}}_B^N \right]^{\frac{1}{2}}$$

The flow rule defining the rate of molecular relaxation reads

$$\mathbf{L}_B^F = \dot{\gamma}_B^F \mathbf{N}_B$$

Where

$$\mathbf{N}_B = \frac{1}{\sqrt{2} \tau_B} \boldsymbol{\tau}_B^{dev}, \quad \tau_B = \sqrt{\frac{1}{2} \boldsymbol{\tau}_B^{dev} : \boldsymbol{\tau}_B^{dev}}$$

The rate of relaxation is taken equal to

$$\dot{\gamma}_B^F = C \left( \frac{1}{\bar{\lambda}_F - 1} \right) \tau_B$$

Where

$$\bar{\lambda}_F = \left[ \frac{1}{3} \text{tr} \left( \mathbf{F}_B^F \{ \mathbf{F}_B^F \}^T \right) \right]^{\frac{1}{2}}$$

The model has been implemented into LS-DYNA using a semi-implicit stress-update scheme [Moran et. al 1990], and is available for the explicit solver only.

**\*MAT\_ARUP\_ADHESIVE**

This is Material Type 169. This material model was written for adhesive bonding in aluminum structures. The plasticity model is not volume-conserving, and hence avoids the spuriously high tensile stresses that can develop if adhesive is modeled using traditional elasto-plastic material models. It is available **only** for solid elements of formulations 1, 2 and 15. The smallest dimension of the element is assumed to be the through-thickness dimension of the bond, unless THKDIR=1.

Note: This Material Type will be available starting in release 3 of version 971.

Card 1            1            2            3            4            5            6            7            8

Variable	MID	RO	E	PR	TENMAX	GCTEN	SHRMAX	GCSHR
Type	A8	F	F	F	F	F	F	F
Default	none	none	none	none	1.e20	1.e20	1.e20	1.e20

Card 2            1            2            3            4            5            6            7            8

Variable	PWRT	PWRS	SHRP	SHT_SL	EDOT0	EDOT2	THKDIR	EXTRA
Type	F	F	F	F	F	F	F	F
Default	2.0	2.0	0.0	0.0	1.0	0.0	0.0	0.0

**Define Card 3 and 4 only if EXTRA=1 or 3, otherwise omit both cards**

Card 3            1            2            3            4            5            6            7            8

Variable	TMAXE	GCTE	SMAXE	GCSE	PWRTE	PWRSE		
Type	F	F	F	F	F	F		
Default	1.e20	1.e20	1.e20	1.e20	2.0	2.0		



Card 4            1            2            3            4            5            6            7            8

Variable	FACET	FACCT	FACES	FACCS	SOFTT	SOFTS		
Type	F	F	F	F	F	F		
Default	1.0	1.0	1.0	1.0	1.0	1.0		

**Define the following card for rate effects only if EDOT2 is non-zero**

Card 5            1            2            3            4            5            6            7            8

Variable	SDFAC	SGFAC	SDEFAC	SGEFAC				
Type	F	F	F	F				
Default	1.0	1.0	1.0	1.0				

**Define the following card for bond thickness only if EXTRA = 2 or 3.**

Card 6            1            2            3            4            5            6            7            8

Variable	BTHK							
Type	F							
Default	0.0							

<u>VARIABLE</u>	<u>DESCRIPTION</u>
MID	Material identification. A unique number or label not exceeding 8 characters must be specified.
RO	Mass density.
E	Young's modulus.
PR	Poisson's ratio.

<u>VARIABLE</u>	<u>DESCRIPTION</u>
TENMAX	Maximum through-thickness tensile stress
GCTEN	Energy per unit area to fail the bond in tension
SHRMAX	Maximum through-thickness shear stress
GCSHR	Energy per unit area to fail the bond in shear
PWRT	Power law term for tension
PWRS	Power law term for shear
SHRP	Shear plateau ratio (Optional)
SHT_SL	Slope (non-dimensional) of yield surface at zero tension (See Remarks)
EDOT0	Strain rate at which the “static” properties apply
EDOT2	Strain rate at which the “dynamic” properties apply (Card 5)
THKDIR	Through-thickness direction flag (See remarks) EQ.0.0: smallest element dimension (default) EQ.1.0: direction from nodes 1-2-3-4 to nodes 5-6-7-8
EXTRA	Flag to input further data: EQ.1.0 interfacial failure properties (cards 3 and 4) EQ.2.0 bond thickness (card 6) EQ.3.0 both of the above
TMAXE	Maximum tensile force per unit length on edges of joint
GCTE	Energy per unit length to fail the edge of the bond in tension
SMAXE	Maximum shear force per unit length on edges of joint
GCSE	Energy per unit length to fail the edge of the bond in shear
PWRTE	Power law term for tension
PWRSE	Power law term for shear
FACET	Stiffness scaling factor for edge elements - tension
FACCT	Stiffness scaling factor for interior elements - tension
FACES	Stiffness scaling factor for edge elements - shear
FACCS	Stiffness scaling factor for interior elements - shear

<u>VARIABLE</u>	<u>DESCRIPTION</u>
SOFTT	Factor by which the tensile strength is reduced when a neighbor fails
SOFTS	Factor by which the shear strength is reduced when a neighbor fails

**Data for rate effects (Card 5):**

SDFAC	Factor on TENMAX and SHRMAX at strain rate EDOT2
SGFAC	Factor on GCTEN and GCSHR at strain rate EDOT2
SDEFAC	Factor on TMAXE and SMAXE at strain rate EDOT2
SDGFAC	Factor on GCTE and GCSE at strain rate EDOT2

**Data for bond thickness (Card 6):**

BTHK	Bond thickness (overrides thickness from element dimensions) LT.0.0:  BTHK  is bond thickness, but critical time step remains unaffected. Helps to avoid very small time steps, but it can affect stability.
------	---

**Remarks:**

The through-thickness direction is identified from the smallest dimension of each element by default (THKDIR=0.0). It is expected that this dimension will be smaller than in-plane dimensions (typically 1-2mm compared with 5-10mm). If this is not the case, one can set the through-thickness direction via element numbering (THKDIR=1.0). Then the thickness direction is expected to point from lower face (nodes 1-2-3-4) to upper face (nodes 5-6-7-8). For wedge elements these faces are the two triangular faces (nodes 1-2-5) and (nodes 3-4-6).

The bond thickness is assumed to be the element size in the thickness direction. This may be overridden using BTHK. In this case the behavior becomes independent of the element thickness. The elastic stiffness is affected by BTHK, so it is necessary to set the characteristic element length to a smaller value:  $l_e^{new} = \sqrt{BTHK \cdot l_e^{old}}$ . This again affects the critical time step of the element, i.e. a small BTHK can decrease the element time step significantly.

In-plane stresses are set to zero: it is assumed that the stiffness and strength of the substrate is large compared with that of the adhesive, given the relative thicknesses.

If the substrate is modeled with shell elements, it is expected that these will lie at the mid-surface of the substrate geometry. Therefore the solid elements representing the adhesive will be thicker than the actual bond. If the elastic compliance of the bond is significant, this can be corrected by increasing the elastic stiffness property E.

The yield and failure surfaces are treated as a power-law combination of direct tension and shear across the bond:

$$\left(\frac{\sigma}{\sigma_{\max}}\right)^{PWRT} + \left(\frac{\tau}{\tau_{\max} - SHT\_SL * \sigma}\right)^{PWS} = 1.0$$

At yield SHT\_SL is the slope of the yield surface at  $\sigma = 0$ .

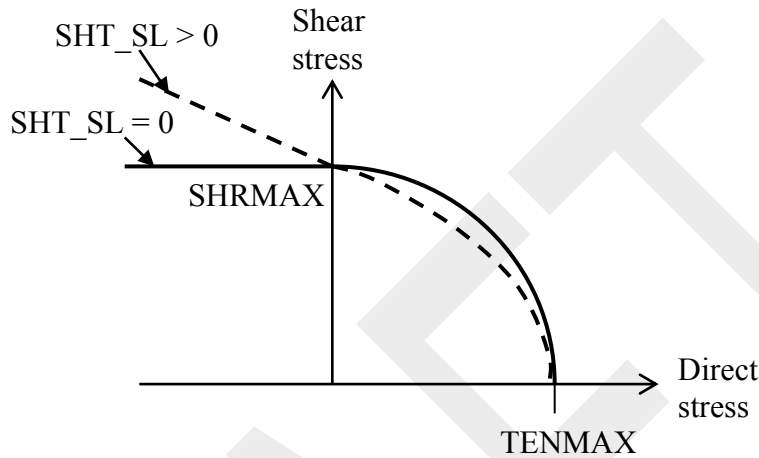

Figure 169.1

The stress-displacement curves for tension and shear are shown in the diagrams below. In both cases, Gc is the area under the curve.

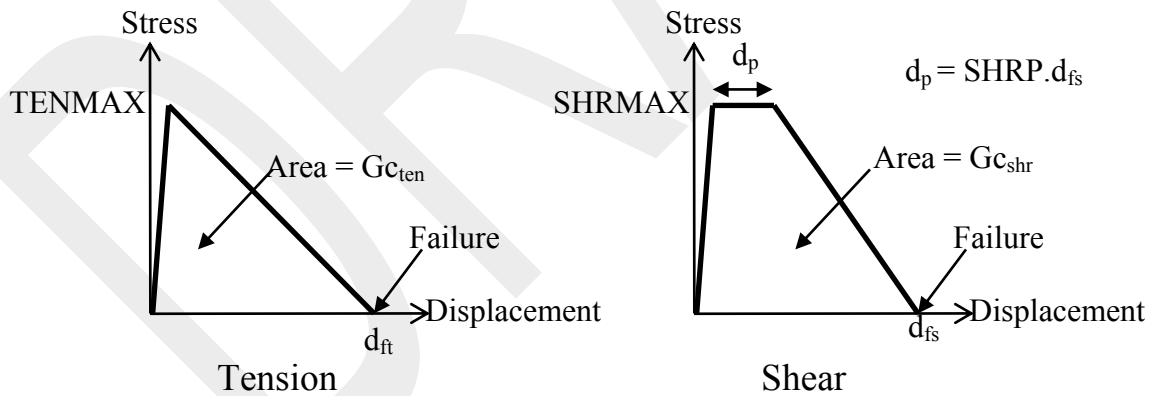

Figure 169.2

Because of the algorithm used, yielding in tension across the bond does not require strains in the plane of the bond – unlike the plasticity models, plastic flow is not treated as volume-conserving.

The Plastic Strain output variable has a special meaning:

0 < ps < 1: ps is the maximum value of the yield function experienced since time zero

1 < ps < 2: the element has yielded and the strength is reducing towards failure – yields

at ps=1, fails at ps=2.

The damage cause by cohesive deformation (0 at first yield to 1 at failure) and by interfacial deformation are stored in the first two extra history variables. These can be plotted if NEIPH on \*DATABASE\_EXTENT\_BINARY is 2 or more. By this means, the reasons for failure may be assessed.

When the plastic strain rate rises above EDOT0, rate effects are assumed to scale with log(plastic strain rate), as in the example below for cohesive tensile strength with dynamic factor SDFAC. The same form of relationship is applied for the other dynamic factors. If EDOT0 is zero or blank, no rate effects are applied.

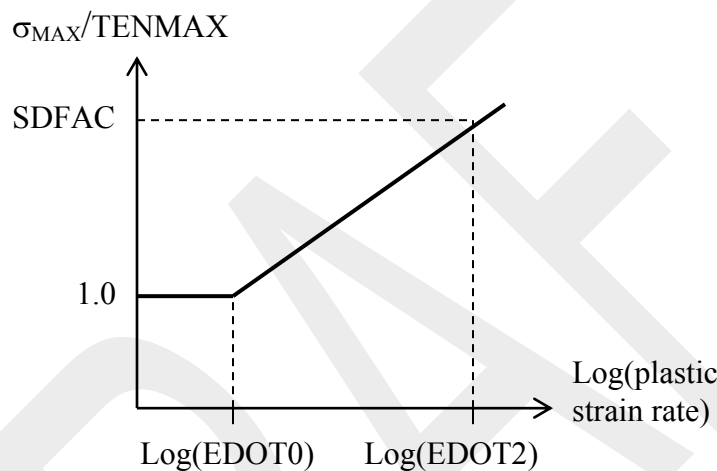

Figure 169.3

Rate effects are applied using the viscoplastic method.

Interfacial failure is assumed to arise from stress concentrations at the edges of the bond – typically the strength of the bond becomes almost independent of bond length. This type of failure is usually more brittle than cohesive failure. To simulate this, LS-DYNA identifies the free edges of the bond (made up of element faces that are not shared by other elements of material type \*MAT\_ARUP\_ADHESIVE, excluding the faces that bond to the substrate). Only these elements can fail initially. The neighbors of failed elements can then develop free edges and fail in turn. In real adhesive bonds, the stresses at the edges can be concentrated over very small areas; in typical finite element models the elements are much too large to capture this. Therefore the concentration of loads onto the edges of the bond is accomplished artificially, by stiffening elements containing free edges (e.g. FACET, FACES >1) and reducing the stiffness of interior elements (e.g. FACCT, FACCS <1). Interior elements are allowed to yield at reduced loads (equivalent to TMAXE\*FACET/FACCT and SMAXE\*FACES/FACCS) – this is to prevent excessive stresses developing before the edge elements have failed - but cannot be damaged until they become edge elements after the failure of their neighbors.

**\*MAT\_RESULTANT\_ANISOTROPIC**

This is Material Type 170. This model is available the Belytschko-Tsay and the C0 triangular shell elements and is based on a resultant stress formulation. In-plane behavior is treated separately from bending in order to model perforated materials such as television shadow masks. The plastic behavior of each resultant is specified with a load curve and is completely uncoupled from the other resultants. If other shell formulations are specified, the formulation will be automatically switched to Belytschko-Tsay. As implemented, this material model cannot be used with user defined integration rules.

Card 1            1            2            3            4            5            6            7            8

Variable	MID	RO						
Type	A8	F						

Card 2            1            2            3            4            5            6            7            8

Variable	E11P	E22P	V12P	V21P	G12P	G23P	G31P	
Type	F	F	F	F	F	F	F	

Card 3            1            2            3            4            5            6            7            8

Variable	E11B	E22B	V12B	V21B	G12B	AOPT		
Type	F	F	F	F	F	F		

Card 4            1            2            3            4            5            6            7            8

Variable	LN11	LN22	LN12	LQ1	LQ2	LM11	LM22	LM12
Type	F	F	F	F	F	F	F	F

Card 5            1            2            3            4            5            6            7            8

Variable				A1	A2	A3		
Type				F	F	F		

Card 6            1            2            3            4            5            6            7            8

Variable	V1	V2	V3	D1	D2	D3	BETA	
Type	F	F	F	F	F	F	F	

**VARIABLE**

**DESCRIPTION**

- MID            Material identification. A unique number or label not exceeding 8 characters must be specified.
- RO            Mass density.
- E11P             $E_{11p}$ , for in plane behavior.
- E22P             $E_{22p}$ , for in plane behavior.
- V12P             $v_{12p}$ , for in plane behavior.
- V11P             $v_{21p}$ , for in plane behavior.
- G12P             $G_{12p}$ , for in plane behavior.
- G23P             $G_{23p}$ , for in plane behavior.
- G31P             $G_{31p}$ , for in plane behavior.
- E11B             $E_{11b}$ , for bending behavior.
- E22B             $E_{22b}$ , for bending behavior.
- V12B             $v_{12b}$ , for bending behavior.
- V21B             $v_{21b}$ , for bending behavior.

<b>VARIABLE</b>	<b>DESCRIPTION</b>
G12B	$G_{12b}$ , for bending behavior.
AOPT	Material axes option (see MAT_OPTION TROPIC_ELASTIC for a more complete description): EQ.0.0: locally orthotropic with material axes determined by element nodes 1, 2, and 4, as with *DEFINE_COORDINATE_NODES, and then rotated about the shell element normal by the angle BETA. EQ.2.0: globally orthotropic with material axes determined by vectors defined below, as with *DEFINE_COORDINATE_VECTOR. EQ.3.0: locally orthotropic material axes determined by rotating the material axes about the element normal by an angle, BETA, from a line in the plane of the element defined by the cross product of the vector $\mathbf{v}$ with the element normal. LT.0.0: the absolute value of AOPT is a coordinate system ID number (CID on *DEFINE_COORDINATE_NODES, *DEFINE_COORDINATE_SYSTEM or *DEFINE_COORDINATE_VECTOR). Available in R3 version of 971 and later.
LN11	Yield curve ID for $N_{11}$ .
LN22	Yield curve ID for $N_{22}$ .
LN12	Yield curve ID for $N_{12}$ .
LQ1	Yield curve ID for $Q_1$ .
LQ2	Yield curve ID for $Q_2$ .
LM11	Yield curve ID for $M_{11}$ .
LM22	Yield curve ID for $M_{22}$ .
LM12	Yield curve ID for $M_{12}$ .
A1,A2,A3	$a_1 a_2 a_3$ , define components of vector $\mathbf{a}$ for AOPT = 2.
V1,V2,V3	$v_1 v_2 v_3$ , define components of vector $\mathbf{v}$ for AOPT = 3.
D1,D2,D3	$d_1 d_2 d_3$ , define components of vector $\mathbf{d}$ for AOPT = 2.
BETA	Material angle in degrees for AOPT = 0 and 3, may be overridden on the element card, see *ELEMENT_SHELL_BETA.



**Remarks:**

The in-plane elastic matrix for in-plane, plane stress behavior is given by:

$$C_{in\ plane} = \begin{bmatrix} Q_{11p} & Q_{12p} & 0 & 0 & 0 \\ Q_{12p} & Q_{22p} & 0 & 0 & 0 \\ 0 & 0 & Q_{44p} & 0 & 0 \\ 0 & 0 & 0 & Q_{55p} & 0 \\ 0 & 0 & 0 & 0 & Q_{66p} \end{bmatrix}$$

The terms  $Q_{ip}$  are defined as:

$$Q_{11p} = \frac{E_{11p}}{1 - \nu_{12p}\nu_{21p}}$$

$$Q_{22p} = \frac{E_{22p}}{1 - \nu_{12p}\nu_{21p}}$$

$$Q_{12p} = \frac{\nu_{12p}E_{11p}}{1 - \nu_{12p}\nu_{21p}}$$

$$Q_{44p} = G_{12p}$$

$$Q_{55p} = G_{23p}$$

$$Q_{66p} = G_{31p}$$

The elastic matrix for bending behavior is given by:

$$C_{bending} = \begin{bmatrix} Q_{11b} & Q_{12b} & 0 \\ Q_{12b} & Q_{22b} & 0 \\ 0 & 0 & Q_{44b} \end{bmatrix}$$

The terms  $Q_{ip}$  are similarly defined.

# \*MAT\_171

# \*MAT\_STEEL\_CONCENTRIC\_BRACE

## \*MAT\_STEEL\_CONCENTRIC\_BRACE

This is Material Type 171. It represents the cyclic buckling and tensile yielding behavior of steel braces and is intended primarily for seismic analysis. Use only for beam elements with ELFORM=2 (Belytschko-Schwer beam).

Note: This Material Type will be available starting in release 3 of version 971.

Card 1            1            2            3            4            5            6            7            8

Variable	MID	RO	YM	PR	SIGY	LAMDA	FBUCK	FBUCK2
Type	A8	F	F	F	F	F	F	F
Default	none	none	none	none	none	See Remarks	See Remarks	0.0

Card 2            1            2            3            4            5            6            7            8

Variable	CCBRF	BCUR						
Type	F	F						
Default	See Remarks							

Card 3            1            2            3            4            5            6            7            8

Variable	TS1	TS2	TS3	TS4	CS1	CS2	CS3	CS4
Type	F	F	F	F	F	F	F	F
Default	0	0	0	0	=TS1	=TS2	=TS3	=TS4

<u>VARIABLE</u>	<u>DESCRIPTION</u>
MID	Material identification. A unique number or label not exceeding 8 characters must be specified.
RO	Mass density
YM	Young's Modulus
PR	Poisson's Ratio
SIGY	Yield stress
LAMDA	Slenderness ratio (optional – see note)
FBUCK	Initial buckling load (optional – see note. If used, should be positive)
FBUCK2	Optional extra term in initial buckling load – see note
CCBRF	Reduction factor on initial buckling load for cyclic behavior
BCUR	Optional load curve giving compressive buckling load (y-axis) versus compressive strain (x-axis - both positive)
TS1-TS4	Tensile axial strain thresholds 1 to 4
CS1-CS4	Compressive axial strain thresholds 1 to 4

**Remarks:**

The brace element is intended to represent the buckling, yielding and cyclic behavior of steel elements such as tubes or I-sections that carry only axial loads. Empirical relationships are used to determine the buckling and cyclic load-deflection behavior. A single beam element should be used to represent each structural element.

The cyclic behavior is shown in the graph (compression shown as negative force and displacement).

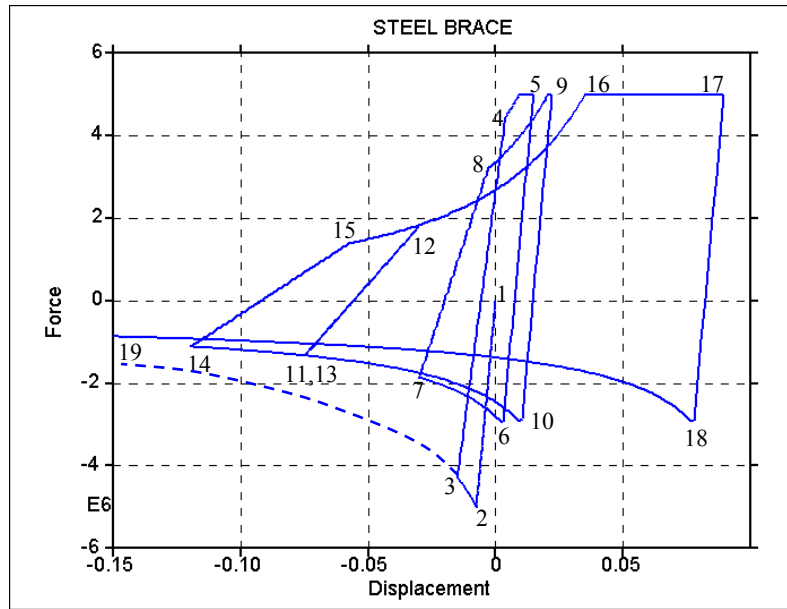

The initial buckling load (point 2) is:

$$F_{b\,initial} = FBUCK + FBUCK2 / L^2$$

where FBUCK, FBUCK2 are input parameters and L is the length of the beam element. If neither FBUCK nor FBUCK2 are defined, the default is that the initial buckling load is

$$SIGY * A \quad (A = \text{cross-sectional area}).$$

The buckling curve (shown dashed) has the form:

$$F(d) = F_{b\,initial} / \sqrt{A\delta + B}$$

where  $\delta$  is abs(strain/yield strain), and A and B are internally-calculated functions of slenderness ratio ( $\lambda$ ) and loading history.

The member slenderness ratio  $\lambda$  is defined as  $\frac{kL}{r}$ , where  $k$  depends on end conditions,  $L$  is the element length, and  $r$  is the radius of gyration such that  $Ar^2 = I$  (and  $I = \min(I_{yy}, I_{zz})$ );  $\lambda$  will by default be calculated from the section properties and element length using  $k=1$ . Optionally, this may be overridden by input parameter LAMDA to allow for different end conditions.

Optionally, the user may provide a buckling curve (BCUR). The points of the curve give compressive displacement (x-axis) versus force (y-axis); the first point should have zero displacement and the initial buckling force. Displacement and force should both be positive. The initial buckling force must not be greater than the yield force.

The tensile yield force (point 5 and section 16-17) is defined by

$$F_y = SIGY * A,$$

where yield stress SIGY is an input parameter and A is the cross-sectional area.

Following initial buckling and subsequent yield in tension, the member is assumed to be damaged. The initial buckling curve is then scaled by input parameter CCBRF, leading to reduced strength curves such as segments 6-7, 10-14 and 18-19. This reduction factor is typically in the range 0.6 to 1.0 (smaller values for more slender members). By default, CCBRF is calculated using SEAOC 1990:

$$CCBRF = \frac{1}{\left(1 + \frac{0.5\lambda}{C_c}\right)} \quad \text{and} \quad C_c = \pi \sqrt{\frac{E}{0.5\sigma_y}}$$

When tensile loading is applied after buckling, the member must first be straightened before the full tensile yield force can be developed. This is represented by a reduced unloading stiffness (e.g. segment 14-15) and the tensile reloading curve (segments 8-9 and 15-16). Further details can be found in Bruneau, Uang, and Whittaker [1998] and Structural Engineers Association of California [1974, 1990, 1996].

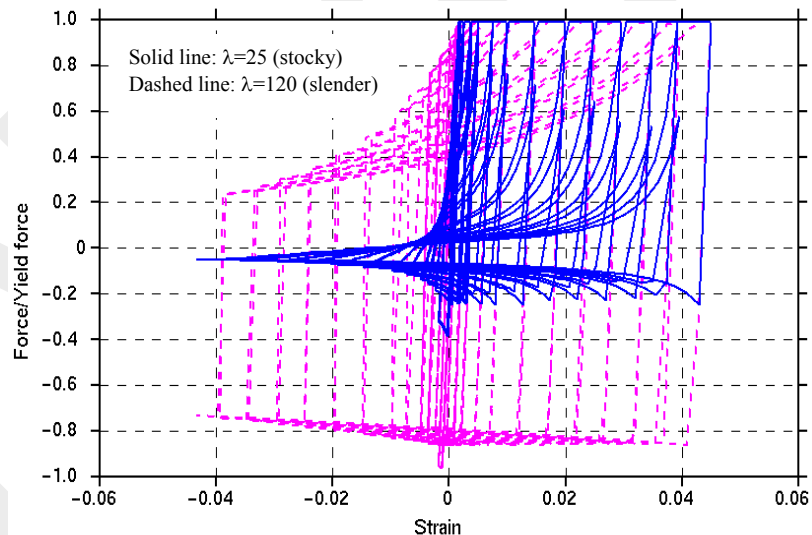

**Figure 171.2**

The response of stocky (low  $\lambda$ ) and slender (high  $\lambda$ ) braces are compared in the graph. These differences are achieved by altering the input value LAMDA (or the section properties of the beam) and FBUCK.

### Output

Axial Strain and Internal Energy may be plotted from the INTEGRATED beam results menus in Oasys Ltd. Post processors: D3PLOT and T/HIS.

FEMA thresholds are the total axial strains (defined by change of length/initial length) at which the element is deemed to have passed from one category to the next, e.g. “Elastic”, “Immediate Occupancy”, “Life Safe”, etc. During the analysis, the maximum tensile and compressive strains (“high tide strains”) are recorded. These are checked against the user-defined limits TS1 to TS4 and CS1 to CS4. The output flag is then set to 0, 1, 2, 3, or 4 according to which limits have been passed. The value in the output files is the highest such flag from tensile or compressive strains. To plot this data, select INTEGRATED beam results, Integration point 4, Axial Strain.

Maximum plastic strains in tension and compression are also output. These are defined as maximum total strain to date minus the yield or first buckling strain for tensile and compressive plastic strains respectively. To plot these, select INTEGRATED beam results, Integration point 4, “shear stress XY” and “shear stress XZ” for tensile and compressive plastic strains, respectively.

## \*MAT\_CONCRETE\_EC2

This is Material Type 172, for shell and Hughes-Liu beam elements only. The material model can represent plain concrete only, reinforcing steel only, or a smeared combination of concrete and reinforcement. The model includes concrete cracking in tension and crushing in compression, and reinforcement yield, hardening and failure. Properties are thermally sensitive; the material model can be used for fire analysis. Material data and equations governing the behavior (including thermal properties) are taken from Eurocode 2 Part 1.2 (General rules – Structural fire design), hereafter referred to as EC2. Although the material model offers many options, a reasonable response may be obtained by entering only RO, FC and FT for plain concrete; if reinforcement is present, YMREINF, SUREINF, FRACRX, FRACRY must be defined.

Card 1            1            2            3            4            5            6            7            8

Variable	MID	RO	FC	FT	TYPEC	UNITC	ECUTEN	FCC6
Type	A8	F	F	F	F	F	F	F
Default	none	none	none	0.0	1.0	1.0	0.0025	FC

Card 2            1            2            3            4            5            6            7            8

Variable	ESOFT	LCHAR	MU	TAUMXF	TAUMXC	ECRAGG	AGGSZ	UNITL
Type	F	F	F	F	F	F	F	F
Default	See notes	0.0	0.4	1.E20	1.161*FT	.001	0.0	1.0

Card 3            1            2            3            4            5            6            7            8

Variable	YMREINF	PRREINF	SUREINF	TYPER	FRACRX	FRACY	LCRSU	LCALPS
Type	F	F	F	F	F	F	I	I
Default	none	0.0	0.0	1.0	0.0	0.0	none	none

Card 4            1            2            3            4            5            6            7            8

Variable	AOPT	ET36	PRT36	ECUT36	LCALPC	DEGRAD	ISHCHK	UNLFAC
Type	F	F	F	F	I	F	I	F
Default	0.0	0.0	0.25	1.E20	none	0.0	0	0.5

**Define Cards 5 and 6 if AOPT is greater than 0.**

Card 5            1            2            3            4            5            6            7            8

Variable	XP	YP	ZP	A1	A2	A3		
Type	F	F	F	F	F	F		
Default	0.0	0.0	0.0	0.0	0.0	0.0		

Card 6            1            2            3            4            5            6            7            8

Variable	V1	V2	V3	D1	D2	D3	BETA	
Type	F	F	F	F	F	F	F	
Default	0.0	0.0	0.0	0.0	0.0	0.0	0.0	



**Omit Card 7 if ISHCHK = 0**

Card 7            1            2            3            4            5            6            7            8

Variable	TYPSEC	P_OR_F	EFFD	GAMSC				
Type	F	F	F	F				
Default	0.0	0.0	0.0	0.0				

**Define Card 8 only if TYPEC = 6**

REQ N            1            2            3            4            5            6            7            8

Variable	ECI_6	ECSP_6						
Type	F	F						
Default	see notes	see notes						

**VARIABLE****DESCRIPTION**

MID	Material identification. A unique number or label not exceeding 8 characters must be specified.
RO	Mass density
FC	Compressive strength of concrete (stress units)
FT	Tensile stress to cause cracking
TYPEC	Concrete aggregate type for stress-strain-temperature relationships EQ.1.0: Siliceous (default) EQ.2.0: Calcareous EQ.3.0: Non-thermally-sensitive using ET3, ECU3 EQ.4.0: Lightweight EQ.5.0: Fibre-reinforced EQ.6.0: Non-thermally-sensitive, Mander algorithm
UNITC	Factor to convert stress units to MPa (used in shear capacity checks) e.g. if model units are Newtons and metres, UNITC=1E-6
ECUTEN	Strain to fully open a crack.

VARIABLE	DESCRIPTION
FCC6	Compressive strength of confined concrete (type 6). If blank, unconfined properties are assumed.
ESOFT	Tension stiffening (Slope of stress-strain curve post-cracking in tension)
MU	Friction on crack planes (max shear = mu*compressive stress)
TAUMXF	Maximum friction shear stress on crack planes (ignored if AGGSZ>0 - see notes).
TAUMXC	Maximum through-thickness shear stress after cracking (see notes).
ECRAGG	Strain parameter for aggregate interlock (ignored if AGGSZ>0 - see notes).
AGGSZ	Aggregate size (length units - used in NS3473 aggregate interlock formula - see notes).
UNITL	Factor to convert length units to millimetres (used only if AGGSZ>0 - see notes) e.g. if model unit is metres, UNITL=1000.
LCHAR	Characteristic length at which ESOFT applies, also used as crack spacing in aggregate-interlock calculation
YMREINF	Young's Modulus of reinforcement
PRREINF	Poisson's Ratio of reinforcement
SUREINF	Ultimate stress of reinforcement
TYPER	Type of reinforcement for stress-strain-temperature relationships EQ.1.0: Hot rolled reinforcing steel EQ.2.0: Cold worked reinforcing steel (default) EQ.3.0: Quenched and tempered prestressing steel EQ.4.0: Cold worked prestressing steel EQ.5.0: Non-thermally sensitive using loadcurve LCRSU.
FRACRX	Fraction of reinforcement (x-axis) (e.g. for 1% reinforcement FRACR=0.01).
FRACRY	Fraction of reinforcement (y-axis) (e.g. for 1% reinforcement FRACR=0.01).
LCRSU	Loadcurve for TYPER=5, giving non-dimensional factor on SUREINF versus plastic strain (overrides stress-strain relationships from EC2).

VARIABLE	DESCRIPTION
LCALPS	Optional loadcurve giving thermal expansion coefficient of reinforcement vs temperature – overrides relationship from EC2.
AOPT	Option for local orthotropic axes – see Material Type 2 EQ.0.0: locally orthotropic with material axes determined by element nodes as shown in Figure 2.1. Nodes 1, 2, and 4 of an element are identical to the nodes used for the definition of a coordinate system as by *DEFINE_COORDINATE_NODES. When this option is used in two-dimensional planar and axisymmetric analysis, it is critical that the nodes in the element definition be numbered counterclockwise for this option to work correctly. EQ.1.0: locally orthotropic with material axes determined by a point in space and the global location of the element center; this is the a-direction. This option is for solid elements only. EQ.2.0: globally orthotropic with material axes determined by vectors defined below, as with *DEFINE_COORDINATE_VECTOR. EQ.3.0: locally orthotropic material axes determined by rotating the material axes about the element normal by an angle, BETA, from a line in the plane of the element defined by the cross product of the vector <b>v</b> with the element normal. The plane of a solid element is the midsurface between the inner surface and outer surface defined by the first four nodes and the last four nodes of the connectivity of the element, respectively. LT.0.0: This option has not yet been implemented for this material model.
ET36	Youngs Modulus of concrete (TYPE=3 and 6).
PRT36	Poissons Ratio of concrete (TYPE=3 and 6).
ECUT36	Strain to failure of concrete in compression $\epsilon_{cu}$ (TYPE=3 and 6).
LCALPC	Optional loadcurve giving thermal expansion coefficient of concrete vs temperature – overrides relationship from EC2.
DEGRAD	If non-zero, the compressive strength of concrete parallel to an open crack will be reduced (see notes).
ISHCHK	Flag = 1 to input data for shear capacity check.
UNLFAC	Stiffness degradation factor after crushing (0.0 to 1.0 – see notes).
XP, YP, ZP	Coordinates of point p for AOPT = 1 and 4 (see Mat type 2).
A1, A2, A3	Components of vector a for AOPT = 2 (see Mat type 2).

<u>VARIABLE</u>	<u>DESCRIPTION</u>
V1, V2, V3	Components of vector v for AOPT = 3 and 4 (see Mat type 2).
D1, D2, D3	Components of vector d for AOPT = 2 (see Mat type 2).
TYPESC	Type of shear capacity check EQ.1.0: BS 8110 EQ.2.0:ACI
P_OR_F	If BS8110 shear check, percent reinforcement – e.g. if 0.5%, input 0.5. If ACI shear check, ratio (cylinder strength/FC) - defaults to 1.
EFFD	Effective section depth (length units), used in shear capacity check. This is usually the section depth excluding the cover concrete.
GAMSC	Load factor used in BS8110 shear capacity check.
EC1_6	Strain at maximum compressive stress for Type 6 concrete.
ECSP_6	Spalling strain in compression for Type 6 concrete.

**Remarks:**

Reinforcement is treated as separate sets of bars in the local element x and y axes. The reinforcement is assumed not to carry through-thickness or in-plane shear.

The material model is thermally-sensitive. If no temperatures are defined in the model, it behaves as if at 20degC.

**Creating Reinforced Concrete Sections**

This material model can be used to represent unreinforced concrete (FRACR=0), steel (FRACR=1), or reinforced concrete with evenly distributed reinforcement (0<FRACR<1).

Alternatively, use \*INTEGRATION\_SHELL or \*PART\_COMPOSITE to define the section. Create one material Part for concrete and another for steel, both of type MAT\_CONCRETE\_EC2, one with FRACR=0 (representing the concrete), the other with FRACR=1 (reinforcement bars). Each integration point may then be defined as either concrete or steel as appropriate.

**Material Behavior**

Stress-strain curves for concrete and steel (and their variation with temperature) are as specified in EC2, scaled to the user-supplied FC, FT and SUREINF. Thermal expansion coefficients as functions of temperature are by default taken from EC2. These can optionally be overwritten using LCALPC, LCALPS.

The concrete is assumed to crack in tension when the maximum in-plane principal stress (bending+membrane stress at an integration point) reaches FT. Cracks can open and close repeatedly under hysteretic loading. When a crack is closed it can carry compression according to the normal compressive stress-strain relationships. The direction of the crack relative to the element coordinate system is stored when the crack first forms. The material can carry compression parallel to the crack even when the crack is open. A second crack may form perpendicular to the initial crack.

After initial cracking, the tensile stress reduces with increasing tensile strain. A finite amount of energy must be absorbed to create a fully open crack - in practice the reinforcement holds the concrete together, allowing it to continue to take some tension (this effect is known as tension-stiffening). The options available for the stress-strain relationship are shown below. The bilinear relationship is used by default. The simple linear relationship applies only if ESOFT>0 and ECUTEN=0.

LCHAR can optionally be used to maintain constant energy per unit area of crack irrespective of mesh size, i.e. the crack opening displacement is fixed rather than the crack opening strain. LCHAR\*ECUTEN is then the displacement to fully open a crack. For the actual elements, crack opening displacement is estimated by strain\*SQRT(area). Note that if LCHAR is defined, it is also used as the crack spacing in the NS 3473 aggregate interlock calculation.

The relationship of FT with temperature is taken from EC2 – there is no input option to change this. FT is assumed to remain at its input value at temperatures up to 100 deg C, then to reduce linearly with temperature to zero at 600 deg C. Up to 500deg C, the crack opening strain ECUTEN increases with temperature such that the fracture energy to open the crack remains constant. Above 500 deg C the crack opening strain does not increase further.

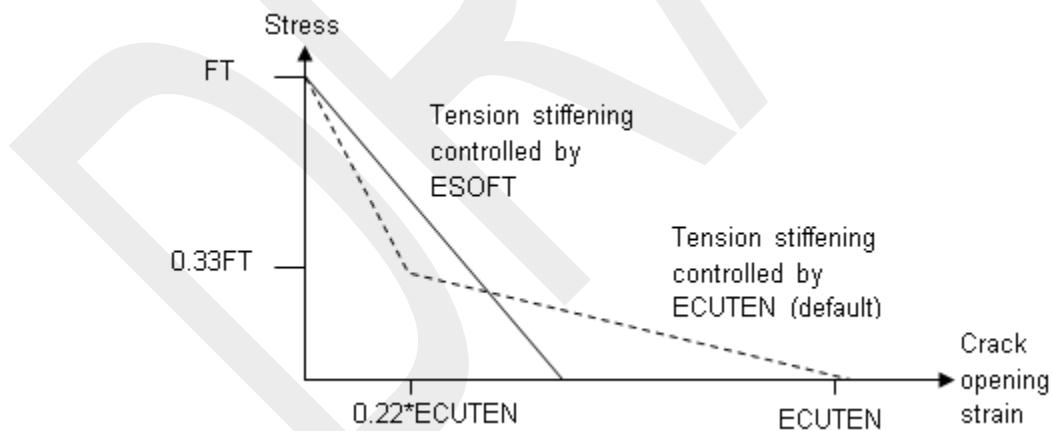

**Tensile Behaviour of Concrete**

Compressive behaviour of the concrete initially follows a curve defined in EC2 as:

$$\text{Stress} = FC_{\max} * [(\epsilon/\epsilon_{c1}) * (3/\{2 + (\epsilon/\epsilon_{c1})^3\})]$$

where  $\epsilon_{c1}$  is the strain at which the ultimate compressive strength  $FC_{max}$  is reached, and  $\epsilon$  is the current equivalent uniaxial compressive strain.

The initial elastic modulus is given by  $E=3FC_{max}/2\epsilon_{c1}$ . On reaching  $FC_{max}$ , the stress decreases linearly with increasing strain, reaching zero at a strain  $\epsilon_{cu}$ . Strains  $\epsilon_{c1}$  and  $\epsilon_{cu}$  are by default taken from EC2 and are functions of temperature. At 20°C they take values 0.0025 and 0.02 respectively.  $FC_{max}$  is also a function of temperature, given by the input parameter FC (which applies at 20°C) times a temperature-dependent softening factor taken from EC2.

Concrete stress-strain behaviour

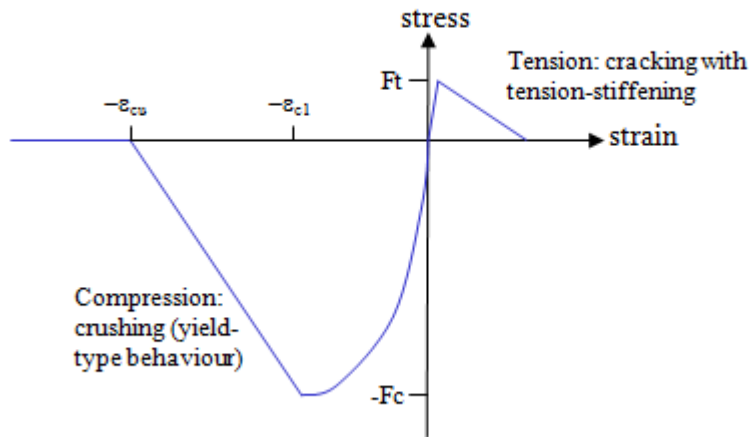

For TYPEC=3, the user over-rides the default values of elastic stiffness and  $\epsilon_{cu}$ . In this case, the strain  $\epsilon_{c1}$  is calculated from the elastic stiffness, and there is no thermal sensitivity. The stress-strain behaviour follows the same form as described above.

For TYPEC=6, the above compressive crushing behaviour is replaced with the equations proposed by Mander. This algorithm can model unconfined or confined concrete; for unconfined, leave FCC6 blank. For confined concrete, input the confined compressive strength as FCC6.

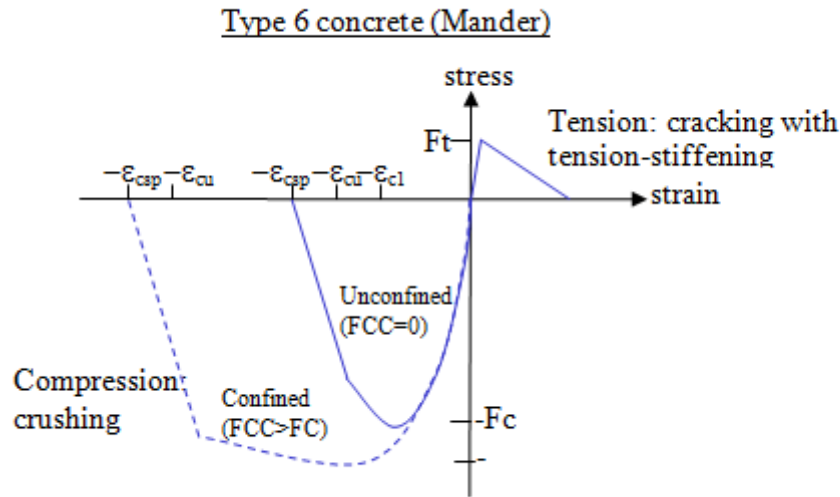

Default values for type 6 are calculated as follows:

$$\epsilon_{cl} = 0.002[1 + 5(FCC6/FC - 1)] - \text{for unconfined concrete, } FCC6=FC \text{ so } \epsilon_{cl} \text{ defaults to } 0.002.$$

$$\epsilon_{cu} = 1.1 * \epsilon_c$$

$$\epsilon_{csp} = \epsilon_{cu} + FCC/E$$

**Unload/reload stiffness (all concrete types)**

During compressive loading, the elastic modulus will be reduced according to the parameter UNLFAC (default = 0.5). UNLFAC=0.0 means no reduction, i.e. the initial elastic modulus will apply during unloading and reloading. UNLFAC=1.0 means that unloading results in no permanent strain. Intermediate values imply a permanent strain linearly interpolated between these extremes.

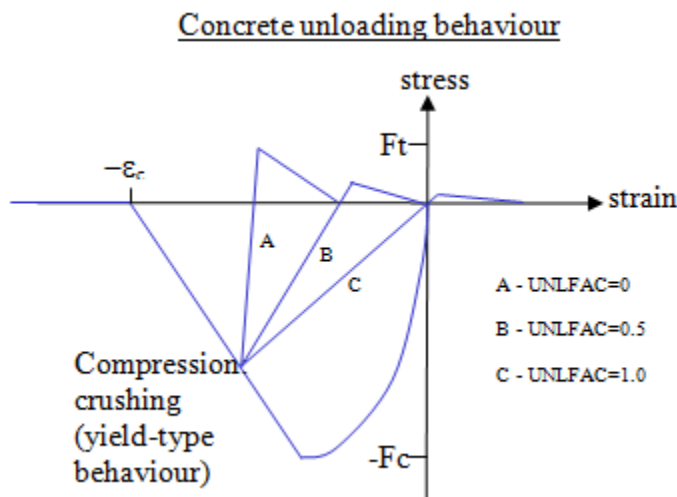

Tensile strength is reduced by the same factor as the elastic modulus as described in the paragraph above.

**Optional compressive strength degradation due to cracking**

By default, the compressive strength of cracked and uncracked elements is the same. If DEGRAD is non-zero, the formula from BS8110 is used to reduce compressive strength parallel to the crack while the crack is open:

Reduction factor =  $\text{Min}(1.0, 1.0/(0.8 + 100\varepsilon_t))$  where  $\varepsilon_t$  is the tensile strain normal to the crack.

**Through-thickness shear strength**

Before cracking, the through-thickness shear stress in the concrete is unlimited. For cracked elements, shear stress on the crack plane (magnitude of shear stress including element-plane and through-thickness terms) is treated in one of two ways:

- If  $\text{AGGSZ} > 0$ , the relationship from Norwegian standard NS3473 is used to model the aggregate-interlock that allows cracked concrete to carry shear loading. In this case, UNITL must be defined. This is the factor that converts model length units to millimetres, i.e. the aggregate size in millimetres =  $\text{AGGSZ} * \text{UNITL}$ . The formula in NS3473 also requires the crack width in millimetres: this is estimated from  $\text{UNITL} * \varepsilon_{\text{cro}} * L_e$ , where  $\varepsilon_{\text{cro}}$  is the crack opening strain and  $L_e$  is the crack spacing, taken as LCHAR if non-zero, or equal to element size if LCHAR is zero. Optionally, TAUMXC may be used to set the maximum shear stress when the crack is closed and the normal stress is zero – by default this is equal to 1.161FT from the formulae in NS3473. If TAUMXC is defined, the shear stress from the NS3473 formula is scaled by  $\text{TAUMXC}/1.161\text{FT}$ .
- If  $\text{AGGSZ}=0$ , the aggregate interlock is modelled by this formula:

$$\tau_{\text{max}} = \text{TAUMXC}/(1.0 + \varepsilon_{\text{cro}}/\text{ECRAGG}) + \text{min}(\text{MU} * \sigma_{\text{comp}}, \text{TAUMXF})$$

Where  $\tau_{\text{max}}$  is the maximum shear stress carried across a crack;  $\sigma_{\text{comp}}$  is the compressive stress across the crack (this is zero if the crack is open); ECRAGG is the crack opening strain at which the input shear strength TAUMXC is halved. Again, TAUMXC defaults to 1.161FT.

Note that if a shear capacity check is specified, the above applies only to in-plane shear, while the through-thickness shear is unlimited.

The reinforcement is treated as separate bars in the local X and Y directions – it does not carry shear in the local XY direction. At 20°C the behaviour is elastic-perfectly-plastic, up to the onset of failure, after which the stress reduces linearly with increasing strain until final failure. The strain at which failure occurs depend on the reinforcement type (TYPER) and the temperature. For example, for hot-rolled reinforcing steel at 20°C failure begins at 15% strain and is complete at 20% strain.

The default stress-strain curve for reinforcement may be overridden using TYPER=5 and LCRSU. In this case, the reinforcement properties are not temperature-sensitive and the yield stress is given by  $\text{SUREINF} * f(\varepsilon_p)$ , where  $f(\varepsilon_p)$  is the loadcurve value at the current plastic strain. To include failure of the reinforcement, the curve should reduce to zero at the desired failure strain and remain zero for higher strains. Note that LS-DYNA re-interpolates the input curve to



have 100 equally-spaced points; if the last point on the curve is at very high strain, then the initial part of the curve may become poorly defined.

### **Local directions**

AOPT and associated data are used to define the directions of the reinforcement bars. If the reinforcement directions are not consistent across neighbouring elements, the response may be less stiff than intended – this is equivalent to the bars being bent at the element boundaries. See material type 2 for description of the different AOPT settings.

### **Shear capacity check**

Shear reinforcement is not included explicitly in this material model. However, a shear capacity check can be made, to show regions that require shear reinforcement. The assumption is that the structure will not yield or fail in through-thickness shear, because sufficient shear reinforcement will be added. Set ISHCHK and TYPESC to 1. Give the percentage reinforcement (P\_OR\_F), effective depth of section EFFD (this typically excludes the cover concrete), and load factor GAMSC. These are used in Table 3.8 of BS 8110-1:1997 to determine the design shear stress. The “shear capacity” is this design shear stress times the total section thickness (i.e. force per unit width), modified according to Equation 6b of BS 8110 to allow for axial load. The “shear demand” (actual shear force per unit width) is then compared to the shear capacity. This process is performed for the two local directions of the reinforcement in each element; when defining sections using integration rules and multiple sets of material properties, it is important that each set of material properties referenced within the same section has the same AOPT and orientation data. Note that the shear demand and axial load (used in calculation of the shear capacity) are summed across the integration points within the section; the same values of capacity, demand, and difference between capacity and demand are then written to all the integration points.

### **Thermal expansion**

By default, thermal expansion properties from EC2 are used. If no temperatures are defined in the model, properties for 20deg C are used. For the user-defined types (TYPEC=3 or 6, TYPER=5) there is no thermal expansion by default, and the properties do not vary with temperature. The user may override the default thermal expansion behaviour by defining curves of thermal expansion coefficient versus temperature (LCALPC, LCALPR). These apply no matter what types TYPEC and TYPER have been selected.

### **Output**

“Plastic Strain” is the maximum of the plastic strains in the reinforcement in the two local directions.

Extra history variables may be requested for shell elements (NEIPS on \*DATABASE\_EXTENT\_BINARY), which have the following meaning:

- Extra Variable 1: Current crack opening strain (if two cracks are present, max of the two)
- Extra Variable 2: Equivalent uniaxial strain for concrete compressive behaviour
- Extra Variable 3: Number of cracks (0, 1 or 2)
- Extra Variable 4: Temperature

Extra Variable 5:	Thermal strain
Extra Variable 6:	Current crack opening strain – first crack to form
Extra Variable 7:	Current crack opening strain – crack at 90 degrees to first crack
Extra Variable 8:	Max crack opening strain – first crack to form
Extra Variable 9:	Max crack opening strain – crack at 90 degrees to first crack
Extra Variable 10:	Maximum difference (shear demand minus capacity) that has occurred so far, in either of the two reinforcement directions
Extra Variable 11:	Maximum difference (shear demand minus capacity) that has occurred so far, in reinforcement x-direction
Extra Variable 12:	Maximum difference (shear demand minus capacity) that has occurred so far, in reinforcement y-direction
Extra Variable 13:	Current shear demand minus capacity, in reinforcement x-direction
Extra Variable 14:	Current shear demand minus capacity, in reinforcement y-direction
Extra Variable 15:	Current shear capacity $V_{cx}$ , in reinforcement x-direction
Extra Variable 16:	Current shear capacity $V_{cy}$ , in reinforcement y-direction
Extra Variable 17:	Current shear demand $V_x$ , in reinforcement x-direction
Extra Variable 18:	Current shear demand $V_y$ , in reinforcement y-direction
Extra Variable 19:	Maximum shear demand that has occurred so far, in reinforcement x-direction
Extra Variable 20:	Maximum shear demand) that has occurred so far, in reinforcement y-direction
Extra Variable 21:	Current strain in reinforcement (x-direction)
Extra Variable 22:	Current strain in reinforcement (y-direction)
Extra Variable 23:	Shear strain (slip) across first crack
Extra Variable 24:	Shear strain (slip) across second crack
Extra Variable 25:	X-Stress in concrete (element local axes)
Extra Variable 26:	Y-Stress in concrete (element local axes)
Extra Variable 27:	XY-Stress in concrete (element local axes)
Extra Variable 28:	YZ-Stress in concrete (element local axes)
Extra Variable 29:	XZ-Stress in concrete (element local axes)
Extra Variable 30:	Reinforcement stress (A-direction)
Extra Variable 31:	Reinforcement stress (B-direction)
Extra Variable 32:	Current shear demand $V_{max}$
Extra Variable 33:	Maximum $V_{max}$ that has occurred so far
Extra Variable 34:	Current shear capacity $V_{theta}$
Extra Variable 35:	Excess shear = $V_{max} - V_{theta}$
Extra Variable 36:	Maximum excess shear that has occurred so far

$V_{max} = \text{Sqrt}(V_x^2 + V_y^2)$  where  $V_x, V_y$  = shear demand in reinforcement x and y directions  
 $V_{theta} = V_{max}/\text{Sqrt}[(V_x/V_{cx})^2 + (V_y/V_{cy})^2]$  where  $V_{cx}, V_{cy}$  = shear capacity in x and y

Note that the concrete stress history variables are stored in element local axes irrespective of AOPT, i.e. local X is always the direction from node 1 to node 2. The reinforcement stresses are in the reinforcement directions; these do take account of AOPT.

MAXINT (shells) and/or BEAMIP (beams) on \*DATABASE\_EXTENT\_BINARY may be set to the maximum number of integration points, so that results for all integration points can be plotted separately.

**\*MAT\_MOHR\_COULOMB**

This is Material Type 173 for solid elements only, is intended to represent sandy soils and other granular materials. Joints (planes of weakness) may be added if required; the material then represents rock. The joint treatment is identical to that of \*MAT\_JOINED\_ROCK.

Card 1            1            2            3            4            5            6            7            8

Variable	MID	RO	GMOD	RNU	(blank)	PHI	CVAL	PSI
Type	A8	F	F	F		F	F	F
Default								0.0

Card 2            1            2            3            4            5            6            7            8

Variable	(blank)	NPLANES	(blank)	LCCPDR	LCCPT	LCCJDR	LCCJT	LCSFAC
Type		I		I	I	I	I	I
Default		0		0	0	0	0	0

Card 3            1            2            3            4            5            6            7            8

Variable	GMODDP	GMODGR	LCGMEP	LCPHIEP	LCPSIEP	LCGMST	CVALGR	ANISO
Type	F	F	F	F	F	F	F	F
Default	0.0	0.0	0.0	0.0	0.0	0.0	0.0	1.0

**Card 4 – Repeat for each plane (maximum 6 planes)**

Card 4            1            2            3            4            5            6            7            8

Variable	DIP	DIPANG	CPLANE	FRPLANE	TPLANE	SHRMAX	LOCAL	
Type	F	F	F	F	F	F	F	
Default	0.0	0.0	0.0	0.0	0.0	1.e20	0.0	

<u>VARIABLE</u>	<u>DESCRIPTION</u>
MID	Material identification. A unique number or label not exceeding 8 characters must be specified.
RO	Mass density
GMOD	Elastic shear modulus
RNU	Poisson's ratio
PHI	Angle of friction (radians)
CVAL	Cohesion value (shear strength at zero normal stress)
PSI	Dilation angle (radians)
NPLANES	Number of joint planes (maximum 6)
LCCPDR	Load curve for extra cohesion for parent material (dynamic relaxation)
LCCPT	Load curve for extra cohesion for parent material (transient)
LCCJDR	Load curve for extra cohesion for joints (dynamic relaxation)
LCCJT	Load curve for extra cohesion for joints (transient)
LCSFAC	Load curve giving factor on strength vs. time
GMODDP	Z-coordinate at which GMOD and CVAL are correct
GMODGR	Gradient of GMOD versus z-coordinate (usually negative)
LCGMEP	Load curve of GMOD versus plastic strain (overrides GMODGR)
LCPHIEP	Load curve of PHI versus plastic strain

VARIABLE	DESCRIPTION
LCPSIEP	Load curve of PSI versus plastic strain
LCGMST	(Leave blank)
CVALGR	Gradient of CVAL versus z-coordinate (usually negative)
ANISO	Factor applied to elastic shear stiffness in global XZ and YZ planes
DIP	Angle of the plane in degrees below the horizontal
DIPANG	Plan view angle (degrees) of downhill vector drawn on the plane
CPLANE	Cohesion for shear behavior on plane
PHPLANE	Friction angle for shear behavior on plane (degrees)
TPLANE	Tensile strength across plane (generally zero or very small)
SHRMAX	Max shear stress on plane (upper limit, independent of compression)
LOCAL	EQ.0: DIP and DIPANG are with respect to the global axes EQ.1: DIP and DIPANG are with respect to the local element axes

### Remarks:

- The material has a Mohr Coulomb yield surface, given by  $\tau_{\max} = C + \sigma_n \tan(\phi)$ , where  $\tau_{\max}$  = maximum shear stress on any plane,  $\sigma_n$  = normal stress on that plane (positive in compression),  $C$  = cohesion,  $\phi$  = friction angle. The plastic potential function is of the form  $\beta \sigma_k - \sigma_i + \text{constant}$ , where  $\sigma_k$  = maximum principal stress,  $\sigma_i$  = minimum principal stress, and  $\beta = \frac{(1 + \sin(\psi))}{1 - \sin(\psi)}$ .
- The tensile strength of the material is given by  $\sigma_{\max} = \frac{C}{\tan(\phi)}$  where  $C$  is the cohesion. After the material reaches its tensile strength, further tensile straining leads to volumetric voiding; the voiding is reversible if the strain is reversed.
- If depth-dependent properties are used, the model must be oriented with the z-axis in the upward direction.
- Plastic strain is defined as  $\text{SQRT}(2/3 \cdot \epsilon_{\text{p}ij} \cdot \epsilon_{\text{p}ij})$ , i.e. the same way as for other elasto-plastic material models.

5. Friction and dilation angles PHI and PSI may vary with plastic strain, to model heavily consolidated materials under large shear strains – as the strain increases, the dilation angle typically reduces to zero and the friction angle to a lower, pre-consolidation value.
6. For similar reasons, the shear modulus may reduce with plastic strain, but this option may sometimes give unstable results.
7. The loadcurves LCCPDR, LCCPT, LCCJDR, LCCJT allow extra cohesion to be specified as a function of time. The cohesion is additional to that specified in the material parameters. This is intended for use during the initial stages of an analysis to allow application of gravity or other loads without cracking or yielding, and for the cracking or yielding then to be introduced in a controlled manner. This is done by specifying extra cohesion that exceeds the expected stresses initially, then declining to zero. If no curves are specified, no extra cohesion is applied.
8. The loadcurve for factor on strength applies simultaneously to the cohesion and  $\tan(\text{friction angle})$  of parent material and all joints. This feature is intended for reducing the strength of the material gradually, to explore factors of safety. If no curve is present, a constant factor of 1 is assumed. Values much greater than 1.0 may cause problems with stability.
9. The anisotropic factor ANISO applies the elastic shear stiffness in the global XZ and YZ planes. It can be used only in pure Mohr-Coulomb mode (NPLANES=0).
10. To model soil, set NJOINT=0. The joints are to allow modeling of rock, and are treated identically to those of \*MAT\_JOINTED\_ROCK.
11. The joint plane orientations are defined by the angle of a “downhill vector” drawn on the plane, i.e. the vector is oriented within the plane to obtain the maximum possible downhill angle. DIP is the angle of this line below the horizontal. DIPANG is the plan-view angle of the line (pointing down hill) measured clockwise from the global Y-axis about the global Z-axis.
12. Joint planes would generally be defined in the global axis system if they are taken from survey data. However, the material model can also be used to represent masonry, in which case the weak planes represent the cement and lie parallel to the local element axes.
13. The joint planes rotate with the rigid body motion of the elements, irrespective of whether their initial definitions are in the global or local axis system.
14. Extra variables for plotting. By setting NEIPH on \*DATABASE\_EXTENT\_BINARY to 27, the following variables can be plotted in Oasys D3PLOT, Oasys T/HIS and LS-Prepost:
  - Extra Variable 1: Mobilized strength fraction for base material
  - Extra Variable 2: Volumetric void strain
  - Extra Variable 3: Maximum stress overshoot during plastic calculation
  - Extra Variables 4 – 9: crack opening strain for planes 1 - 6

Extra Variables 10 - 15: crack accumulated shear strain for planes 1 - 6

Extra Variables 16 - 20: current shear utilization for planes 1 - 6

Extra Variables 21 - 27: maximum shear utilization to date for planes 1 - 6

DRAFT

**\*MAT\_RC\_BEAM**

This is Material Type 174, for Hughes-Liu beam elements only. The material model can represent plain concrete only, reinforcing steel only, or a smeared combination of concrete and reinforcement. The main emphasis of this material model is the cyclic behavior – it is intended primarily for seismic analysis.

Note: This Material Type will be available starting in release 3 of version 971.

Card 1            1            2            3            4            5            6            7            8

Variable	MID	RO	EUNL	PR	FC	EC1	EC50	RESID
Type	A8	F	F	F	F	F	F	F
Default	none	none	See Remarks	0.0	none	0.0022	See Remarks	0.2

Card 2            1            2            3            4            5            6            7            8

Variable	FT	UNITC	(blank)	(blank)	(blank)	ESOFT	LCHAR	OUTPUT
Type	F	F	F	F	F	F	F	F
Default	See Remarks	1.0	none	none	none	See Remarks	none	0

Card 3            1            2            3            4            5            6            7            8

Variable	FRACR	YMREINF	PRREINF	SYREINF	SUREINF	ESHR	EUR	RREINF
Type	F	F	F	F	F	F	F	F
Default	0.0	none	0.0	0.0	SYREINF	0.03	0.2	4.0



<u>VARIABLE</u>	<u>DESCRIPTION</u>
MID	Material identification. A unique number or label not exceeding 8 characters must be specified.
RO	Mass density
EUNL	Initial unloading elastic modulus (See Remarks).
PR	Poisson's ratio.
FC	Cylinder strength (stress units)
EC1	Strain at which stress FC is reached.
EC50	Strain at which the stress has dropped to 50% FC
RESID	Residual strength factor
FT	Maximum tensile stress
UNITC	Factor to convert stress units to MPa (See Remarks)
ESOFT	Slope of stress-strain curve post-cracking in tension
LCHAR	Characteristic length for strain-softening behavior
OUTPUT	Output flag controlling what is written as "plastic strain" EQ.0.0: Curvature EQ.1.0: "High-tide" plastic strain in reinforcement
FRACR	Fraction of reinforcement (e.g. for 1% reinforcement FRACR=0.01)
YMREINF	Young's Modulus of reinforcement
PRREINF	Poisson's Ratio of reinforcement
SYREINF	Yield stress of reinforcement
SUREINF	Ultimate stress of reinforcement
ESHR	Strain at which reinforcement begins to harden
EUR	Strain at which reinforcement reaches ultimate stress
R_REINF	Dimensionless Ramberg-Osgood parameter $r$ . If zero, a default value $r=4.0$ will be used. If set to -1, parameters will be calculated from Kent & Park formulae. (See Remarks)

**Remarks:****Creating sections for reinforced concrete beams**

This material model can be used to represent unreinforced concrete (FRACR=0), steel (FRACR=1), or reinforced concrete with evenly distributed reinforcement ( $0 < \text{FRACR} < 1$ ).

Alternatively, use \*INTEGRATION\_BEAM to define the section. A new option in allows the user to define a Part ID for each integration point, similar to the facility already available with \*INTEGRATION\_SHELL. All parts referred to by one integration rule must have the same material type, but can have different material properties. Create one Part for concrete, and another for steel. These Parts should reference Materials, both of type \*MAT\_RC\_BEAM, one with FRACR=0, the other with FRACR=1. Then, by assigning one or other of these Part Ids to each integration point the reinforcement can be applied to the correct locations within the section of the beam.

**Concrete**

In monotonic compression, the approach of Park and Kent, as described in Park & Paulay [1975] is used. The material follows a parabolic stress-strain curve up to a maximum stress equal to the cylinder strength FC; thereafter the strength decays linearly with strain until the residual strength is reached. Default values for some material parameters will be calculated automatically as follows:

$$EC50 = \frac{(3 + 0.29FC)}{145FC - 1000} \quad (\text{FC in MPa units – Park and Kent, from test data})$$

EUNL = initial tangent slope =  $2FC/EC1$  (User-defined values lower than this are not permitted, but higher values may be defined if desired)

$$FT = 1.4 \left( \frac{FC}{10} \right)^{\frac{2}{3}} \quad (\text{FC in MPa units – from CEB Code 1993})$$

ESOFT = EUNL (User-defined values higher than EUNL are not permitted)

UNITC is used only to calculate default values for the above parameters from FC.

Strain-softening behavior tends to lead to deformations being concentrated in one element, and hence the overall force-deflection behavior of the structure can be mesh-size-dependent if the softening is characterized by strain. To avoid this, a characteristic length (LCHAR) may be defined. This is the length of specimen (or element) that would exhibit the defined monotonic stress-strain relationship. LS-DYNA adjusts the stress-strain relationship after ultimate load for each element, such that all elements irrespective of their length will show the same deflection during strain softening (i.e. between ultimate load and residual load). Therefore, although deformation will still be concentrated in one element, the load-deflection behavior should be the same irrespective of element size. For tensile behavior, ESOFT is similarly scaled.

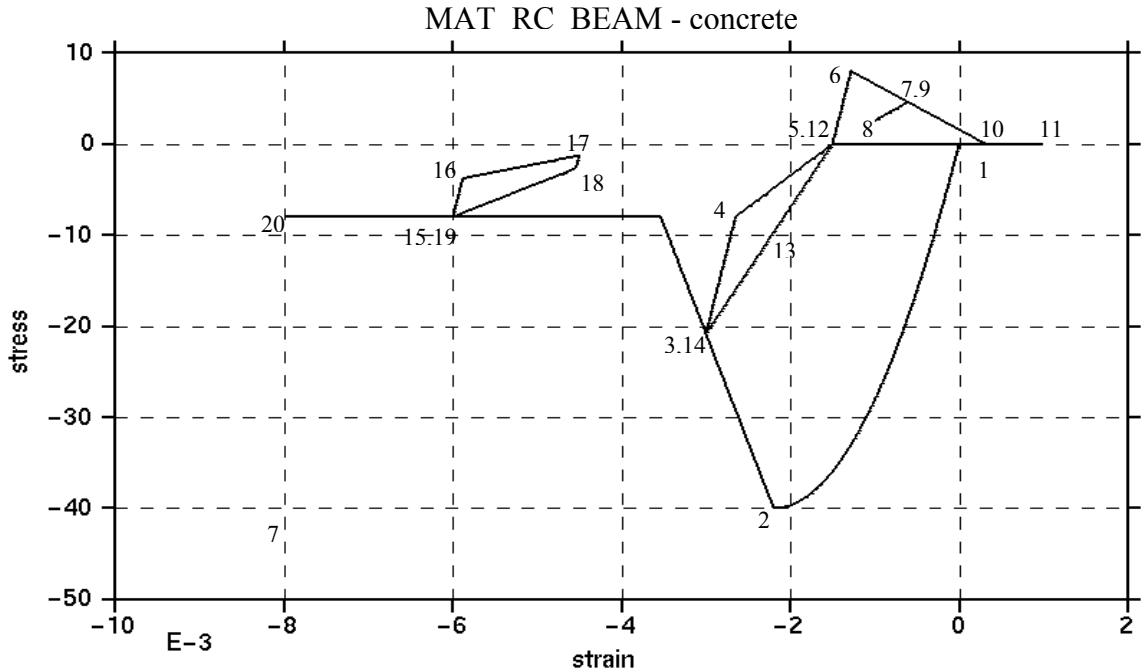

Figure 174.1

Cyclic behavior is broadly suggested by Blakeley and Park [1973] as described in Park & Paulay [1975]; the stress-strain response lies within the Park-Kent envelope, and is characterized by stiff initial unloading response at slope EUNL followed by a less stiff response if it unloads to less than half the current strength. Reloading stiffness degrades with increasing strain.

In tension, the stress rises linearly with strain until a tensile limit  $F_T$  is reached. Thereafter the stiffness and strength decays with increasing strain at a rate ESOFT. The stiffness also decays such that unloading always returns to strain at which the stress most recently changed to tensile.

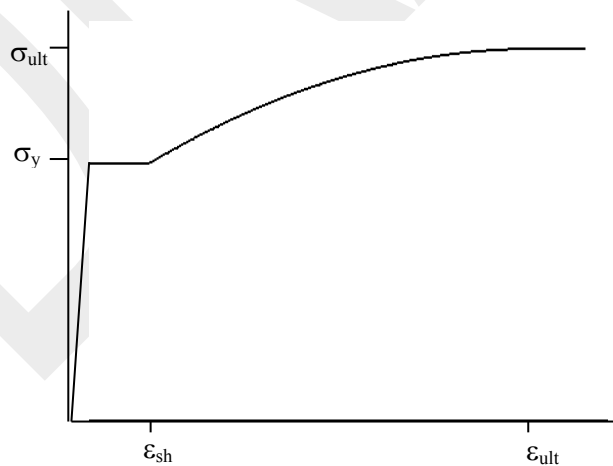

Figure 174.2

Monotonic loading of the reinforcement results in the stress-strain curve shown, which is parabolic between  $\epsilon_{sh}$  and  $\epsilon_{ult}$ . The same curve acts as an envelope on the hysteretic behavior, when the x-axis is cumulative plastic strain.

Unloading from the yielded condition is elastic until the load reverses. Thereafter, the Bauschinger Effect (reduction in stiffness at stresses less than yield during cyclic deformation) is represented by following a Ramberg-Osgood relationship until the yield stress is reached:

$$\epsilon - \epsilon_s = \left(\frac{\sigma}{E}\right) \left\{ 1 + \left(\frac{\sigma}{\sigma_{CH}}\right)^{r-1} \right\}$$

where  $\epsilon$  and  $\sigma$  are strain and stress,  $\epsilon_s$  is the strain at zero stress,  $E$  is Young's Modulus, and  $r$  and  $\sigma_{CH}$  are as defined below

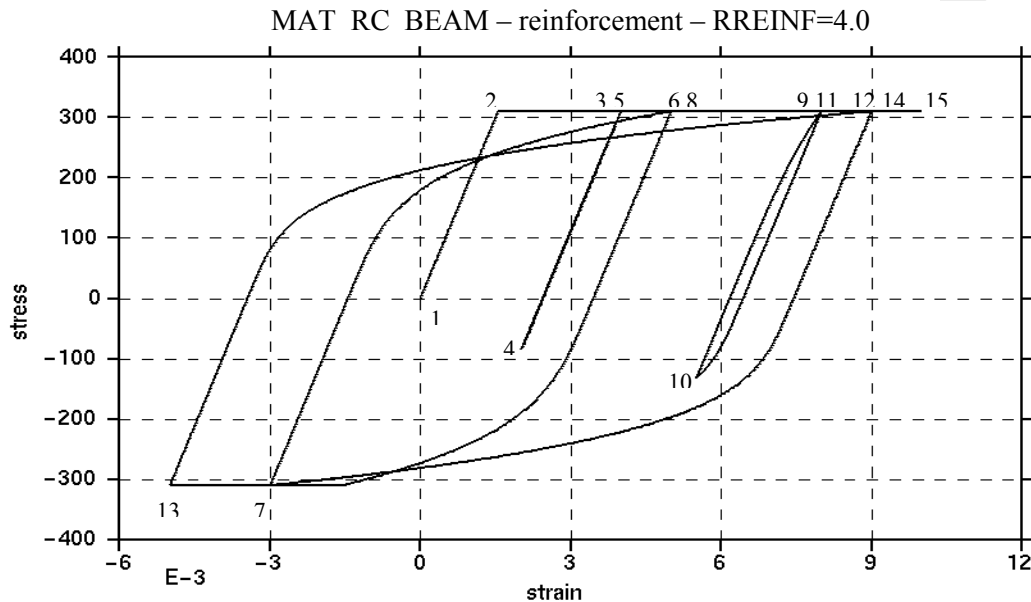

Figure 174.3

Two options are given for calculation  $r$  and  $\sigma_{CH}$ , which is performed at each stress reversal:

1. If RREINF is input as -1,  $r$  and  $\sigma_{CH}$  are calculated internally from formulae given in Kent and Park. Parameter  $r$  depends on the number of stress reversals. Parameter  $\sigma_{CH}$  depends on the plastic strain that occurred between the previous two stress reversals. The formulae were statistically derived from experiments, but may not fit all circumstances. In particular, large differences in behavior may be caused by the presence or absence of small stress reversals such as could be caused by high frequency oscillations. Therefore, results might sometimes be unduly sensitive to small changes in the input data.
2. If RREINF is entered by the user or left blank,  $r$  is held constant while  $\sigma_{CH}$  is calculated on each reversal such that the Ramberg-Osgood curve meets the monotonic stress-strain

curve at the point from which it last unloaded, e.g. points 6 and 8 are coincident in the graph below. The default setting RREINF=4.0 gives similar hysteresis behavior to that described by Kent & Park but is unlikely to be so sensitive to small changes of input data.

**Output**

It is recommended to use BEAMIP on \*DATABASE\_EXTENT\_BINARY to request stress and strain output at the individual integration points. If this is done, for MAT\_RC\_BEAM only, element curvature is written to the output files in place of plastic strain. In the post-processor, select “plastic strain” to display curvature (whichever of the curvatures about local y and z axes has greatest absolute value will be plotted). Alternatively, select “axial strain” to display the total axial strain (elastic + plastic) at that integration point; this can be combined with axial stress to create hysteresis plots such as those shown above.

**\*MAT\_VISCOELASTIC\_THERMAL**

This is Material Type 175. This material model provides a general viscoelastic Maxwell model having up to 12 terms in the prony series expansion and is useful for modeling dense continuum rubbers and solid explosives. Either the coefficients of the prony series expansion or a relaxation curve may be specified to define the viscoelastic deviatoric and bulk behavior.

Card 1            1            2            3            4            5            6            7            8

Variable	MID	RO	BULK	PCF	EF	TREF	A	B
Type	A8	F	F	F	F	F	F	F

**Insert a blank card here if constants are defined on cards 3,4,... below.**

**If an elastic layer is defined in a laminated shell this card must be blank.**

Card 2            1            2            3            4            5            6            7            8

Variable	LCID	NT	BSTART	TRAMP	LCIDK	NTK	BSTART K	TRAMPK
Type	F	I	F	F	F	I	F	F

**Card Format for viscoelastic constants. Up to 12 cards may be input. A keyword card (with a "\*" in column 1) terminates this input if less than 12 cards are used. These cards are not needed if relaxation data is defined. The number of terms for the shear behavior may differ from that for the bulk behavior: simply insert zero if a term is not included.**

**If an elastic layer is defined you only need to define GI and KI (note in an elastic layer only one card is needed)**

Optional Cards            1            2            3            4            5            6            7            8

Variable	GI	BETAI	KI	BETAKI				
Type	F	F	F	F				

VARIABLE	DESCRIPTION
MID	Material identification. A unique number or label not exceeding 8 characters must be specified.
RO	Mass density.
BULK	Elastic bulk modulus.
PCF	Tensile pressure elimination flag for solid elements only. If set to unity tensile pressures are set to zero.
EF	Elastic flag (if equal 1, the layer is elastic. If 0 the layer is viscoelastic).
TREF	Reference temperature for shift function (must be greater than zero).
A	Coefficient for the Arrhenius and the Williams-Landau-Ferry shift functions.
B	Coefficient for the Williams-Landau-Ferry shift function.
LCID	Load curve ID for deviatoric behavior if constants, $G_i$ , and $\beta_i$ are determined via a least squares fit. This relaxation curve is shown below.
NT	Number of terms in shear fit. If zero the default is 6. Fewer than NT terms will be used if the fit produces one or more negative shear moduli. Currently, the maximum number is set to 6.
BSTART	In the fit, $\beta_1$ is set to zero, $\beta_2$ is set to BSTART, $\beta_3$ is 10 times $\beta_2$ , $\beta_4$ is 10 times $\beta_3$ , and so on. If zero, BSTART is determined by an iterative trial and error scheme.
TRAMP	Optional ramp time for loading.
LCIDK	Load curve ID for bulk behavior if constants, $K_i$ , and $\beta_{\kappa_i}$ are determined via a least squares fit. This relaxation curve is shown below.
NTK	Number of terms desired in bulk fit. If zero the default is 6. Currently, the maximum number is set to 6.
BSTARTK	In the fit, $\beta_{\kappa_1}$ is set to zero, $\beta_{\kappa_2}$ is set to BSTARTK, $\beta_{\kappa_3}$ is 10 times $\beta_{\kappa_2}$ , $\beta_{\kappa_4}$ is 10 times $\beta_{\kappa_3}$ , and so on. If zero, BSTARTK is determined by an iterative trial and error scheme.
TRAMPK	Optional ramp time for bulk loading.
GI	Optional shear relaxation modulus for the $i$ th term

VARIABLE	DESCRIPTION
BETA <sub>I</sub>	Optional shear decay constant for the <i>i</i> th term
K <sub>I</sub>	Optional bulk relaxation modulus for the <i>i</i> th term
BETA <sub>K<sub>I</sub></sub>	Optional bulk decay constant for the <i>i</i> th term

**Remarks:**

Rate effects are taken into account through linear viscoelasticity by a convolution integral of the form:

$$\sigma_{ij} = \int_0^t g_{ijkl}(t-\tau) \frac{\partial \varepsilon_{kl}}{\partial \tau} d\tau$$

where  $g_{ijkl}(t-\tau)$  is the relaxation functions for the different stress measures. This stress is added to the stress tensor determined from the strain energy functional.

If we wish to include only simple rate effects, the relaxation function is represented by six terms from the Prony series:

$$g(t) = \sum_{m=1}^N G_m e^{-\beta_m t}$$

We characterize this in the input by shear moduli,  $G_i$ , and decay constants,  $\beta_i$ . An arbitrary number of terms, up to 6, may be used when applying the viscoelastic model.

For volumetric relaxation, the relaxation function is also represented by the Prony series in terms of bulk moduli:

$$k(t) = \sum_{m=1}^N K_m e^{-\beta_{k_m} t}$$

The Arrhenius and Williams-Landau-Ferry (WLF) shift functions account for the effects of the temperature on the stress relaxation. A scaled time,  $t'$ ,

$$t' = \int_0^t \Phi(T) dt$$

is used in the relaxation function instead of the physical time. The Arrhenius shift function is

$$\Phi(T) = \exp\left(-A \left\{ \frac{1}{T} - \frac{1}{T_{REF}} \right\}\right)$$



and the Williams-Landau-Ferry shift function is

$$\Phi(T) = \exp\left(-A \frac{T - T_{REF}}{B + T - T_{REF}}\right)$$

If all three values (TREF, A, and B) are not zero, the WLF function is used; the Arrhenius function is used if B is zero; and no scaling is applied if all three values are zero.

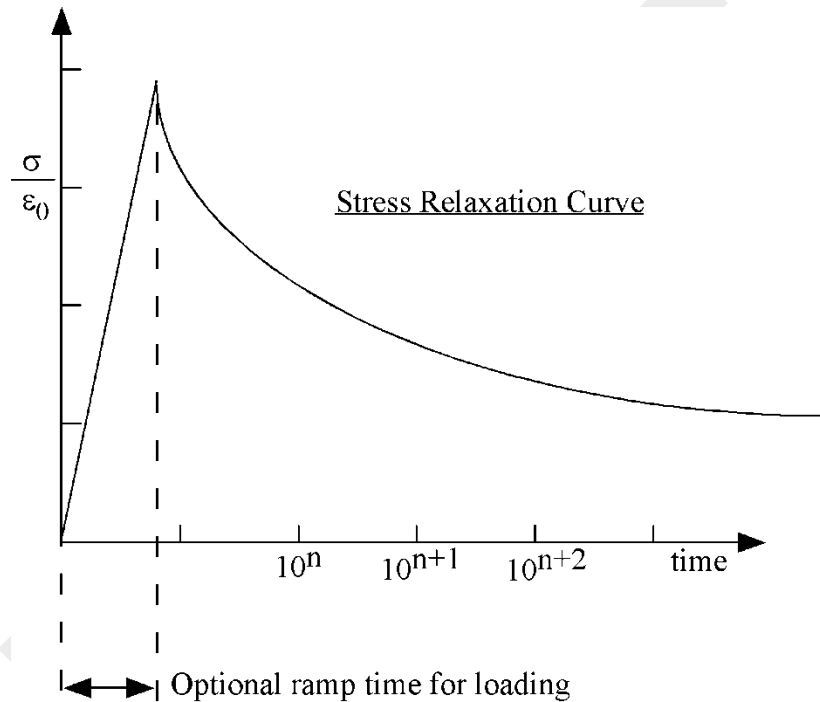

**Figure 175.1.** Relaxation curve. This curve defines stress versus time where time is defined on a logarithmic scale. For best results, the points defined in the load curve should be equally spaced on the logarithmic scale. Furthermore, the load curve should be smooth and defined in the positive quadrant. If nonphysical values are determined by least squares fit, LS-DYNA will terminate with an error message after the initialization phase is completed. If the ramp time for loading is included, then the relaxation which occurs during the loading phase is taken into account. This effect may or may not be important.

**\*MAT\_QUASILINEAR\_VISCOELASTIC**

Purpose: This is Material Type 176. This is a quasi-linear, isotropic, viscoelastic material based on a one-dimensional model by Fung [1993], which represents biological soft tissues such as brain, skin, kidney, spleen, etc. This model is implemented for solid and shell elements. The formulation has recently been changed to allow larger strains, and, in general, will not give the same results as the previous implementation which remains the default.

Card 1            1            2            3            4            5            6            7            8

Variable	MID	RO	K	LC1	LC2	N	GSTART	M
Type	A8	F	F	I	I	F	F	F
Default	none	none	none	0	0	6	1/TMAX	6

Card 2            1            2            3            4            5            6            7            8

Variable	SO	E_MIN	E_MAX	GAMA1	GAMA2	K	EH	FORM
Type	F	F	F	F	F	F	F	I
Default	0.0	-0.9	5.1	0.0	0.0	0.0	0.0	0

**Define the following 3 cards if and only if LC1 is 0.**

Card 3            1            2            3            4            5            6            7            8

Variable	G1	BETA1	G2	BETA2	G3	BETA3	G4	BETA4
Type	F	F	F	F	F	F	F	F

Card 4            1            2            3            4            5            6            7            8

Variable	G5	BETA5	G6	BETA6	G7	BETA7	G8	BETA8
Type	F	F	F	F	F	F	F	F

Card 5            1            2            3            4            5            6            7            8

Variable	G9	BETA9	G10	BETA10	G11	BETA11	G12	BETA12
Type	F	F	F	F	F	F	F	F

**Define the following card if and only if LC2 is 0.**

Card 3 or 6       1            2            3            4            5            6            7            8

Variable	C1	C2	C3	C4	C5	C6		
Type	F	F	F	F	F	F		

#### VARIABLE

#### DESCRIPTION

MID	Material identification. A unique number or label not exceeding 8 characters must be specified.
RO	Mass density.
K	Bulk modulus.
LC1	Load curve ID that defines the relaxation function in shear. This curve is used to fit the coefficients $G_i$ and $BETA_i$ . If zero, define the coefficients directly. The latter is recommended.
LC2	Load curve ID that defines the instantaneous elastic response in compression and tension. If zero, define the coefficients directly. <i>Symmetry is not assumed if only the tension side is define; therefore, defining the response in tension only, may lead to nonphysical behavior in compression. Also, this curve should give a softening response for increasing strain without any negative or zero slopes. A stiffening curve or one with negative slopes is generally unstable.</i>

<u>VARIABLE</u>	<u>DESCRIPTION</u>
N	Number of terms used in the Prony series, a number less than or equal to 6. This number should be equal to the number of decades of time covered by the experimental data. Define this number if LC1 is nonzero. Carefully check the fit in the D3HSP file to ensure that it is valid, since the least square fit is not always reliable.
GSTART	Starting value for least square fit. If zero, a default value is set equal to the inverse of the largest time in the experiment. Define this number if LC1 is nonzero.
M	Number of terms used to determine the instantaneous elastic response. This variable is ignored with the new formulation but is kept for compatibility with the previous input.
SO	Strain (logarithmic) output option to control what is written as component 7 to the d3plot database. (LS-Prepost always blindly labels this component as effective plastic strain.) The maximum values are updated for each element each time step: EQ.0.0: maximum principal strain that occurs during the calculation, EQ.1.0: maximum magnitude of the principal strain values that occurs during the calculation, EQ.2.0: maximum effective strain that occurs during the calculation.
E_MIN	Minimum strain used to generate the load curve from Ci. The default range is -0.9 to 5.1. The computed solution will be more accurate if the user specifies the range used to fit the Ci. Linear extrapolation is used outside the specified range.
E_MAX	Maximum strain used to generate the load curve from Ci.
K	Material failure parameter that controls the volume enclosed by the failure surface, see *MAT_SIMPLIFIED_RUBBER. LE.0.0: ignore failure criterion; GT.0.0: use actual K value for failure criterions.
GAMA1	Material failure parameter, see *MAT_SIMPLIFIED_RUBBER and Figure 181.1.
GAMA2	Material failure parameter, see *MAT_SIMPLIFIED_RUBBER.
EH	Damage parameter, see *MAT_SIMPLIFIED_RUBBER.

VARIABLE	DESCRIPTION
FORM	Formulation of model. FORM=0 gives the original model developed by Fung, which always relaxes to a zero stress state as time approaches infinity, and FORM=1 gives the alternative model, which relaxes to the quasi-static elastic response. In general, the two formulations won't give the same responses. Formulation, FORM=-1, is an improvement on FORM=0 where the instantaneous elastic response is used in the viscoelastic stress update, not just in the relaxation, as in FORM=0. Consequently, the constants for the elastic response do not need to be scaled.
Gi	Coefficients of the relaxation function. The number of coefficients is currently limited to 6 although 12 may be read in to maintain compatibility with the previous formulation's input. Define these coefficients if LC1 is set to zero. At least 2 coefficients must be nonzero.
BETAi	Decay constants of the relaxation function. Define these coefficients if LC1 is set to zero. The number of coefficients is currently limited to 6 although 12 may be read in to maintain compatibility with the previous formulation's input.
Ci	Coefficients of the instantaneous elastic response in compression and tension. Define these coefficients only if LC2 is set to zero.

### Remarks:

The equations for the original model (FORM=0) are given as:

$$\sigma_V(t) = \int_0^t G(t-\tau) \frac{\partial \sigma_\varepsilon[\varepsilon(\tau)]}{\partial \varepsilon} \frac{\partial \varepsilon}{\partial \tau} d\tau$$

$$G(t) = \sum_{i=1}^n G_i e^{-\beta t}$$

$$\sigma_\varepsilon(\varepsilon) = \sum_{i=1}^k C_i \varepsilon^i$$

where G is the shear modulus. Effective strain (which can be written to the d3plot database) is calculated as follows:

$$\varepsilon^{effective} = \sqrt{\frac{2}{3} \varepsilon_{ij} \varepsilon_{ij}}$$

The polynomial for instantaneous elastic response should contain only odd terms if symmetric tension-compression response is desired.

The new model (FORM=1) is based on the hyperelastic model used \*MAT\_SIMPLIFIED\_RUBBER assuming incompressibility. The one-dimensional expression for  $\sigma_\varepsilon$  generates the uniaxial stress-strain curve and an additional visco-elastic term is added on,

$$\sigma(\varepsilon, t) = \sigma_{SR}(\varepsilon) + \sigma_V(t)$$

$$\sigma_V(t) = \int_0^t G(t-\tau) \frac{\partial \varepsilon}{\partial \tau} d\tau$$

where the first term to the right of the equals sign is the hyperelastic stress and the second is the viscoelastic stress. Unlike the previous formulation, where the stress always relaxed to zero, the current formulation relaxes to the hyperelastic stress.

\*MAT\_HILL\_FOAM

Purpose: This is Material Type 177. This is a highly compressible foam based on the strain-energy function proposed by Hill [1978]; also see Storakers [1986]. Poisson's ratio effects are taken into account.

Card 1            1            2            3            4            5            6            7            8

Variable	MID	RO	K	N	MU	LCID	FITTYPE	LCSR
Type	A8	F	F	F	F	I	I	I
Default	none	none	none	0	0	0	0	0

**Define the following 2 cards if and only if LCID is 0.**

Card 2            1            2            3            4            5            6            7            8

Variable	C1	C2	C3	C4	C5	C6	C7	C8
Type	F	F	F	F	F	F	F	F

Card 3            1            2            3            4            5            6            7            8

Variable	B1	B2	B3	B4	B5	B6	B7	B8
Type	F	F	F	F	F	F	F	F

Card 4            1            2            3            4            5            6            7            8

Variable	R	M						
Type	F	F						

<u>VARIABLE</u>	<u>DESCRIPTION</u>
MID	Material identification. A unique number or label not exceeding 8 characters must be specified.
RO	Mass density.
K	Bulk modulus. This modulus is used for determining the contact interface stiffness.
N	Material constant. Define if LCID=0 below; otherwise, N is fit from the load curve data. See equations below.
MU	Damping coefficient.
LCID	Load curve ID that defines the force per unit area versus the stretch ratio. This curve can be given for either uniaxial or biaxial data depending on FITTYPE.
FITTYPE	Type of fit: EQ.1: uniaxial data, EQ.2: biaxial data, EQ.3: pure shear data.
LCSR	Load curve ID that defines the uniaxial or biaxial stretch ratio (see FITTYPE) versus the transverse stretch ratio.
Ci	Material constants. See equations below. Define up to 8 coefficients if LCID=0.
Bi	Material constants. See equations below. Define up to 8 coefficients if LCID=0.
R	Mullins effect model <i>r</i> coefficient
M	Mullins effect model <i>m</i> coefficient

**Remarks:**

If load curve data is defined, the fit generated by LS-DYNA must be closely checked in the D3HSP output file. It may occur that the nonlinear least squares procedure in LS-DYNA, which is used to fit the data, is inadequate.

The Hill strain energy density function for this highly compressible foam is given by:

$$W = \sum_{j=1}^m \frac{C_j}{b_j} \left[ \lambda_1^{b_j} + \lambda_2^{b_j} + \lambda_3^{b_j} - 3 + \frac{1}{n} (J^{-nb_j} - 1) \right]$$



where  $C_j$ ,  $b_j$ , and  $n$  are material constants and  $J = \lambda_1\lambda_2\lambda_3$  represents the ratio of the deformed to the undeformed state. The constant  $m$  is internally set to 4. In case number of points in the curve is less than 8, then  $m$  is set to the number of points divided by 2. The principal Cauchy stresses are

$$t_i = \sum_{j=1}^m \frac{C_j}{J} [\lambda_i^{b_j} - J^{-nb_j}] \quad i = 1, 2, 3$$

From the above equations the shear modulus is:

$$\mu = \frac{1}{2} \sum_{j=1}^m C_j b_j$$

and the bulk modulus is:

$$K = 2\mu \left( n + \frac{1}{3} \right)$$

The value for  $K$  defined in the input is used in the calculation of contact forces and for the material time step. Generally, this value should be equal to or greater than the  $K$  given in the above equation.

**\*MAT\_VISCOELASTIC\_HILL\_FOAM**

Purpose: This is Material Type 178. This is a highly compressible foam based on the strain-energy function proposed by Hill [1978]; also see Storakers [1986]. The extension to include large strain viscoelasticity is due to Feng and Hallquist [2002].

Card 1            1            2            3            4            5            6            7            8

Variable	MID	RO	K	N	MU	LCID	FITTYPE	LCSR
Type	A8	F	F	F	F	I	I	I
Default	none	none	none	0	0	0	0	0

Card 2            1            2            3            4            5            6            7            8

Variable	LCVE	NT	GSTART					
Type	I	F	F					
Default	0	6	1/TMAX					

**Define the following 2 cards if and only if LCID is 0.**

Card 3            1            2            3            4            5            6            7            8

Variable	C1	C2	C3	C4	C5	C6	C7	C8
Type	F	F	F	F	F	F	F	F

Card 4            1            2            3            4            5            6            7            8

Variable	B1	B2	B3	B4	B5	B6	B7	B8
Type	F	F	F	F	F	F	F	F

**Card Format for Viscoelastic Constants. Up to 12 cards may be input. A keyword card (with a “\*” in column 1) terminates this input if less than 12 cards are used.**

Cards opt.      1            2            3            4            5            6            7            8

Variable	GI	BETA1						
Type	F	F						

<u>VARIABLE</u>	<u>DESCRIPTION</u>
MID	Material identification. A unique number or label not exceeding 8 characters must be specified.
RO	Mass density.
K	Bulk modulus. This modulus is used for determining the contact interface stiffness.
N	Material constant. Define if LCID=0 below; otherwise, N is fit from the load curve data. See equations below.
MU	Damping coefficient.
LCID	Load curve ID that defines the force per unit area versus the stretch ratio. This curve can be given for either uniaxial or biaxial data depending on FITTYPE. Load curve LCSR below must also be defined.
FITTYPE	Type of fit: EQ.1: uniaxial data, EQ.2: biaxial data.
LCSR	Load curve ID that defines the uniaxial or biaxial stress ratio (see FITTYPE) versus the transverse stretch ratio.
LCVE	Optional load curve ID that defines the relaxation function in shear. This curve is used to fit the coefficients $G_i$ and $BETA_i$ . If zero, define the coefficients directly. The latter is recommended.
NT	Number of terms used to fit the Prony series, which is a number less than or equal to 12. This number should be equal to the number of decades of time covered by the experimental data. Define this number if LCVE is nonzero. Carefully check the fit in the D3HSP file to ensure that it is valid, since the least square fit is not always reliable.

VARIABLE	DESCRIPTION
GSTART	Starting value for least square fit. If zero, a default value is set equal to the inverse of the largest time in the experiment. Define this number if LC1 is nonzero, Ci, Material constants. See equations below. Define up to 8 coefficients.
Ci	Material constants. See equations below. Define up to 8 coefficients if LCID=0.
Bi	Material constants. See equations below. Define up to 8 coefficients if LCID=0.
GI	Optional shear relaxation modulus for the ith term
BETAI	Optional decay constant if ith term

**Remarks:**

If load curve data is defined, the fit generated by LS-DYNA must be closely checked in the D3HSP output file. It may occur that the nonlinear least squares procedure in LS-DYNA, which is used to fit the data, is inadequate.

The Hill strain energy density function for this highly compressible foam is given by:

$$p^{n+1} = p^n e^{-\beta \cdot \Delta t} + K \dot{\epsilon}_{kk} \left( \frac{1 - e^{-\beta \cdot \Delta t}}{\beta} \right) \quad \text{where } \beta = |BETA|$$

where  $C_j$ ,  $b_j$ , and  $n$  are material constants and  $J = \lambda_1 \lambda_2 \lambda_3$  represents the ratio of the deformed to the undeformed state. The principal Cauchy stresses are

$$t_i = \sum_{j=1}^m \frac{C_j}{J} \left[ \lambda_i^{b_j} - J^{-nb_j} \right] \quad i = 1, 2, 3$$

From the above equations the shear modulus is:

$$\mu = \frac{1}{2} \sum_{j=1}^m C_j b_j$$

and the bulk modulus is:

$$K = 2\mu \left( n + \frac{1}{3} \right)$$

The value for K defined in the input is used in the calculation of contact forces and for the material time step. Generally, this value should be equal to or greater than the K given in the above equation.

Rate effects are taken into account through linear viscoelasticity by a convolution integral of the form:

$$\sigma_{ij} = \int_0^t g_{ijkl}(t-\tau) \frac{\partial \epsilon_{kl}}{\partial \tau} d\tau$$

or in terms of the second Piola-Kirchhoff stress,  $S_{ij}$ , and Green's strain tensor,  $E_{ij}$ ,

$$S_{ij} = \int_0^t G_{ijkl}(t-\tau) \frac{\partial E_{kl}}{\partial \tau} d\tau$$

where  $g_{ijkl}(t-\tau)$  and  $G_{ijkl}(t-\tau)$  are the relaxation functions for the different stress measures. This stress is added to the stress tensor determined from the strain energy functional.

If we wish to include only simple rate effects, the relaxation function is represented by six terms from the Prony series:

$$g(t) = \alpha_0 + \sum_{m=1}^N \alpha_m e^{-\beta_m t}$$

given by,

$$g(t) = \sum_{i=1}^n G_i e^{-\beta_i t}$$

This model is effectively a Maxwell fluid which consists of a dampers and springs in series. We characterize this in the input by shear moduli,  $G_i$ , and decay constants,  $\beta_i$ . The viscoelastic behavior is optional and an arbitrary number of terms may be used.

**\*MAT\_LOW\_DENSITY\_SYNTHETIC\_FOAM\_{OPTION}**

This is Material Type 179 (and 180 if the ORTHO option below is active) for modeling rate independent low density foams, which have the property that the hysteresis in the loading-unloading curve is considerably reduced after the first loading cycle. In this material we assume that the loading-unloading curve is identical after the first cycle of loading is completed and that the damage is isotropic, i.e., the behavior after the first cycle of loading in the orthogonal directions also follows the second curve. The main application at this time is to model the observed behavior in the compressible synthetic foams that are used in some bumper designs. Tables may be used in place of load curves to account for strain rate effects.

Available options include:

**<BLANK>**

**ORTHO**

**WITH\_FAILURE**

**ORTHO\_WITH\_FAILURE**

If the foam develops orthotropic behavior, i.e., after the first loading and unloading cycle the material in the orthogonal directions are unaffected then the ORTHO option should be used. If the ORTHO option is active the directionality of the loading is stored. This option requires additional storage to store the history variables related to the orthogonality and is slightly more expensive.

An optional failure criterion is included. A description of the failure model is provided below for material type 181, \*MAT\_SIMPLIFIED\_RUBBER/FOAM.

Card 1            1            2            3            4            5            6            7            8

Variable	MID	RO	E	LCID1	LCID2	HU	BETA	DAMP
Type	A8	F	F	F	F	F	F	F
Default						1.		0.05

Card 2            1            2            3            4            5            6            7            8

Variable	SHAPE	FAIL	BVFLAG	ED	BETA1	KCON	REF	TC
Type	F	F	F	F	F	F	F	F
Default	1.0	0.0	0.0	0.0	0.0	0.0	0.0	1.E+20

**Define the following optional card if and only if LCID1 is negative**

Card 3            1            2            3            4            5            6            7            8

Variable	RFLAG	DTRT						
Type	F	F						
Default	0.0	0.0						

**Define card 3 if and only if the option, WITH\_FAILURE, is active.**

Card 3            1            2            3            4            5            6            7            8

Variable	K	GAMA1	GAMA2	EH				
Type	F	F	F	F				

<u>VARIABLE</u>	<u>DESCRIPTION</u>
MID	Material identification. A unique number or label not exceeding 8 characters must be specified.
RO	Mass density
E	Young's modulus. This modulus is used if the elongations are tensile as described for the *MAT_LOW_DENSITY_FOAM.

VARIABLE	DESCRIPTION
LCID1	<p>Load curve or table ID:</p> <p>GT.0: Load curve ID, see *DEFINE_CURVE, for nominal stress versus strain for the undamaged material.</p> <p>LT.0: -LCID1 is Table ID, see *DEFINE_TABLE, for nominal stress versus strain for the undamaged material as a function of strain rate</p>
LCID2	<p>Load curve or table ID. The load curve ID, see *DEFINE_CURVE, defines the nominal stress versus strain for the damaged material. The table ID, see *DEFINE_TABLE, defines the nominal stress versus strain for the damaged material as a function of strain rate</p>
HU	<p>Hysteretic unloading factor between 0 and 1 (default=1, i.e., no energy dissipation), see also Figure 57.1.</p>
BETA	<p><math>\beta</math>, decay constant to model creep in unloading</p>
DAMP	<p>Viscous coefficient (.05 &lt; recommended value &lt; .50) to model damping effects.</p> <p>LT.0.0:  DAMP  is the load curve ID, which defines the damping constant as a function of the maximum strain in compression defined as:</p> $\epsilon_{\max} = \max(1 - \lambda_1, 1 - \lambda_2, 1 - \lambda_3)$ <p>In tension, the damping constant is set to the value corresponding to the strain at 0. The abscissa should be defined from 0 to 1.</p>
SHAPE	<p>Shape factor for unloading. Active for nonzero values of the hysteretic unloading factor. Values less than one reduces the energy dissipation and greater than one increases dissipation, see also Figure 57.1.</p>
FAIL	<p>Failure option after cutoff stress is reached:</p> <p>EQ.0.0: tensile stress remains at cut-off value,</p> <p>EQ.1.0: tensile stress is reset to zero.</p>
BVFLAG	<p>Bulk viscosity activation flag, see remark below:</p> <p>EQ.0.0: no bulk viscosity (recommended),</p> <p>EQ.1.0: bulk viscosity active.</p>
ED	<p>Optional Young's relaxation modulus, <math>E_d</math>, for rate effects. See comments below.</p>
BETA1	<p>Optional decay constant, <math>\beta_1</math>.</p>



<u>VARIABLE</u>	<u>DESCRIPTION</u>
KCON	Stiffness coefficient for contact interface stiffness. If undefined the maximum slope in stress vs. strain curve is used. When the maximum slope is taken for the contact, the time step size for this material is reduced for stability. In some cases $\Delta t$ may be significantly smaller, and defining a reasonable stiffness is recommended.
REF	Use reference geometry to initialize the stress tensor. The reference geometry is defined by the keyword:*INITIAL_FOAM_REFERENCE_GEOMETRY (see there for more details). EQ.0.0: off, EQ.1.0: on.
TC	Tension cut-off stress
RFLAG	Rate type for input: EQ.0.0: LCID1 and LCID2 should be input as functions of true strain rate EQ.1.0: LCID1 and LCID2 should be input as functions of engineering strain rate.
DTRT	Strain rate averaging flag: EQ.0.0: use weighted running average LT.0.0: average the last 11 values GT.0.0: average over the last DTRT time units.
K	Material failure parameter that controls the volume enclosed by the failure surface. LE.0.0: ignore failure criterion; GT.0.0: use actual K value for failure criterions.
GAMA1	Material failure parameter, see equations below and Figure 181.1.
GAMA2	Material failure parameter, see equations below.
EH	Damage parameter.

**Remarks:**

This model is based on \*MAT\_LOW\_DENSITY\_FOAM. The uniaxial response is shown below with a large shape factor and small hysteretic factor. If the shape factor is not used, the unloading will occur on the loading curve for the second and subsequent cycles.

The damage is defined as the ratio of the current volume strain to the maximum volume strain, and it is used to interpolate between the responses defined by LCID1 and LCID2.

HU defines a hysteretic scale factor that is applied to the stress interpolated from LCID1 and LCID2,

$$\sigma = (HU + (1 - HU) \cdot \min(1, \frac{e_{int}}{e_{max}})^S) \sigma[LCID1, LCID2]$$

where  $e_{int}$  is the internal energy and  $S$  is the shape factor. Setting HU to 1 results in a scale factor of 1. Setting HU close to zero scales the stress by the ratio of the internal energy to the maximum internal energy raised to the power  $S$ , resulting in the stress being reduced when the strain is low.

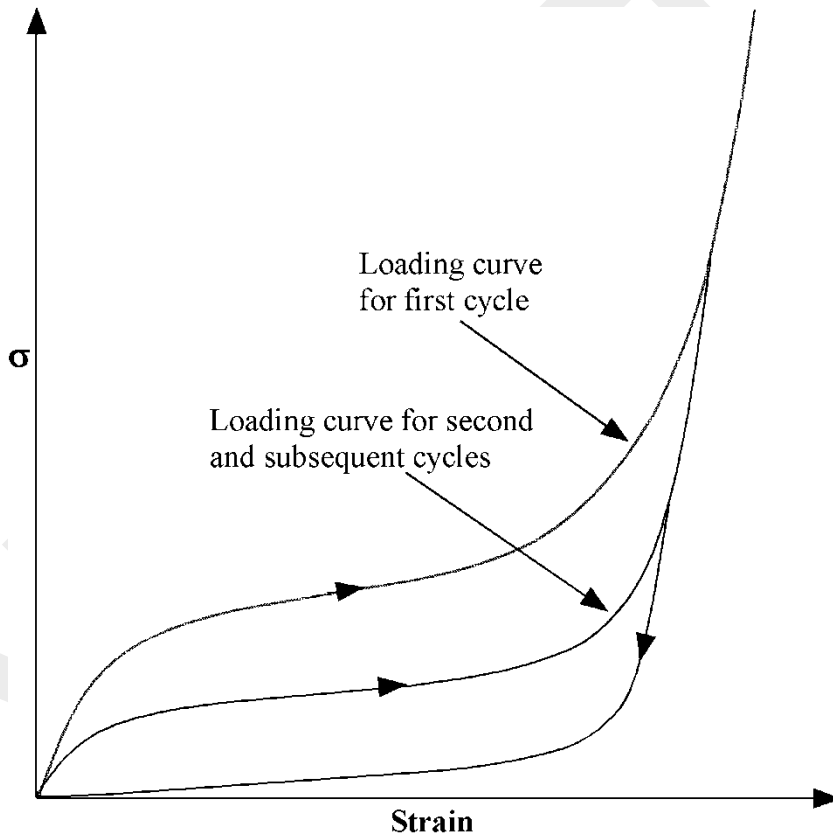

**Figure 179.1.** Loading and reloading curves.

\*MAT\_SIMPLIFIED\_RUBBER/FOAM\_{OPTION}

This is Material Type 181. This material model provides a rubber and foam model defined by a single uniaxial load curve or by a family of uniaxial curves at discrete strain rates. The definition of hysteretic unloading is optional and can be realized via a single uniaxial unloading curve or a two-parameter formulation (starting with 971 release R5). The foam formulation is triggered by defining a Poisson's ratio. This material may be used with both shell and solid elements.

Available options include:

<BLANK>

WITH\_FAILURE

When active, a strain based failure surface is defined suitable for incompressible polymers that models failure in both tension and compression.

This material law has been developed at DaimlerChrysler, Sindelfingen, in collaboration with Paul Du Bois, LSTC, and Prof. Dave J. Benson, UCSD.

Card 1            1            2            3            4            5            6            7            8

Variable	MID	RO	KM	MU	G	SIGF	REF	PRTEN
Type	A8	F	F	F	F	F	F	F

Card 2            1            2            3            4            5            6            7            8

Variable	SGL	SW	ST	LC/TBID	TENSION	RTYPE	AVGOPT	PR/BETA
Type	F	F	F	F	F	F	F	F

Define card 3 if and only if the option, WITH\_FAILURE, is active.

Card 3            1            2            3            4            5            6            7            8

Variable	K	GAMA1	GAMA2	EH				
Type	F	F	F	F				

**Optional card 3 (<BLANK> option) or 4 (WITH\_FAILURE option)**

Card 3/4            1            2            3            4            5            6            7            8

Variable	LCUNLD	HU	SHAPE						
Type	F	F	F						

<u>VARIABLE</u>	<u>DESCRIPTION</u>
MID	Material identification. A unique number or label not exceeding 8 characters must be specified.
RO	Mass density
KM	Linear bulk modulus.
MU	Damping coefficient.
G	Shear modulus for frequency independent damping. Frequency independent damping is based of a spring and slider in series. The critical stress for the slider mechanism is SIGF defined below. For the best results, the value of G should be 250-1000 times greater than SIGF.
SIGF	Limit stress for frequency independent, frictional, damping.
REF	Use reference geometry to initialize the stress tensor. The reference geometry is defined by the keyword:*INITIAL_FOAM_REFERENCE_GEOMETRY (see there for more details). EQ.0.0: off, EQ.1.0: on.
PRTEN	The tensile Poisson's ratio for shells (optional). If PRTEN is zero, PR/BETA will serve as the Poisson's ratio for both tension and compression in shells. If PRTEN is nonzero, PR/BETA will serve only as the compressive Poisson's ratio for shells.
SGL	Specimen gauge length
SW	Specimen width
ST	Specimen thickness

VARIABLE	DESCRIPTION
LC/TBID	Load curve or table ID, see *DEFINE_TABLE, defining the force versus actual change in the gauge length. If the table definition is used a family of curves are defined for discrete strain rates. The load curves should cover the complete range of expected loading, i.e., the smallest stretch ratio to the largest.
TENSION	Parameter that controls how the rate effects are treated. Applicable to the table definition. EQ.-1.0: rate effects are considered during tension and compression loading, but not during unloading, EQ. 0.0: rate effects are considered for compressive loading only, EQ.1.0: rate effects are treated identically in tension and compression.
RTYPE	Strain rate type if a table is defined: EQ.0.0: true strain rate, EQ.1.0: engineering strain rate
AVGOPT	Averaging option determine strain rate to reduce numerical noise. EQ.0.0: simple average of twelve time steps, EQ.1.0: running average of last 12 averages.
PR/BETA	If the value is specified between 0 and 0.5 exclusive, i.e., $0 < PR < 0.50$ the number defined here is taken as Poisson's ratio. If zero, an incompressible rubber like behavior is assumed and a default value of 0.495 is used internally. If a Poisson's ratio of 0.0 is desired, input a small value for PR such as 0.001. When fully integrated solid elements are used and when a nonzero Poisson's ratio is specified, a foam material is assumed and selective-reduced integration is not used due to the compressibility. This is true even if PR approaches 0.500. If any other value excluding zero is define, then BETA is taken as the absolute value of the given number and a nearly incompressible rubber like behavior is assumed. An incrementally updated mean viscous stress develops according to the equation:
	$p^{n+1} = p^n e^{-\beta \cdot \Delta t} + K \dot{\epsilon}_{kk} \left( \frac{1 - e^{-\beta \cdot \Delta t}}{\beta} \right) \quad \text{where } \beta =  BETA $
	The BETA parameter does not apply to highly compressible foam materials.
K	Material failure parameter that controls the volume enclosed by the failure surface. LE.0.0: ignore failure criterion; GT.0.0: use actual K value for failure criterions.

VARIABLE	DESCRIPTION
GAMA1	Material failure parameter, see equations below and Figure 181.1.
GAMA2	Material failure parameter, see equations below.
EH	Damage parameter.
LCUNLD	Load curve, see *DEFINE_CURVE, defining the force versus actual length during unloading. The unload curve should cover exactly the same range as LC or the load curves of TBID and its end points should have identical values, i.e., the combination of LC and LCUNLD or the first curve of TBID and LCUNLD describes a complete cycle of loading and unloading. See also material *MAT_083.
HU	Hysteretic unloading factor between 0 and 1 (default=1., i.e. no energy dissipation), see also material *MAT_083 and Figure 57.1. This option is ignored if LCUNLD is used.
SHAPE	Shape factor for unloading. Active for nonzero values of the hysteretic unloading factor HU. Values less than one reduces the energy dissipation and greater than one increases dissipation, see also material *MAT_083 and Figure 57.1.

**Remarks:**

The frequency independent damping is obtained by the having a spring and slider in series as shown in the following sketch:



The general failure criterion for polymers is proposed by Feng and Hallquist as

$$f(I_1, I_2, I_3) = (I_1 - 3) + \Gamma_1(I_1 - 3)^2 + \Gamma_2(I_2 - 3) = K$$

where  $K$  is a material parameter which controls the size enclosed by the failure surface, and  $I_1$ ,  $I_2$  and  $I_3$  are the three invariants of right Cauchy-Green deformation tensor ( $C$ )

$$I_1 = C_{ii} = \lambda_1^2 + \lambda_2^2 + \lambda_3^2$$

$$I_2 = \frac{1}{2}(C_{ii}C_{jj} - C_{ij}C_{ji}) = \lambda_1^2 \lambda_2^2 + \lambda_1^2 \lambda_3^2 + \lambda_2^2 \lambda_3^2$$

$$I_3 = \det(C) = \lambda_1^2 \lambda_2^2 \lambda_3^2$$

with  $\lambda_i$  are the stretch ratios in three principal directions.

To avoid sudden failure and numerical difficulty, material failure, which is usually a time point, is modeled as a process of damage growth. In this case, the two threshold values are chosen as  $(1 - h)K$  and  $K$ , where  $h$  (also called EH) is a small number chosen based on experimental results reflecting the range between damage initiation and material failure.

The damage is defined as function of  $f$  :

$$D = \begin{cases} 0 & \text{if } f \leq (1 - h)K \\ \frac{1}{2} \left[ 1 + \cos \frac{\pi(f - K)}{hK} \right] & \text{if } (1 - h)K < f < K \\ 1 & \text{if } f \geq K \end{cases}$$

This definition indicates that damage is first-order continuous. Under this definition, the tangent stiffness matrix will be continuous. The reduced stress considering damage effect is

$$\sigma_{ij} = (1 - D) \sigma_{ij}^o$$

where  $\sigma_{ij}^o$  is the undamaged stress. It is assumed that prior to final failure, material damage is recoverable. Once material failure occurs, damage will become permanent.

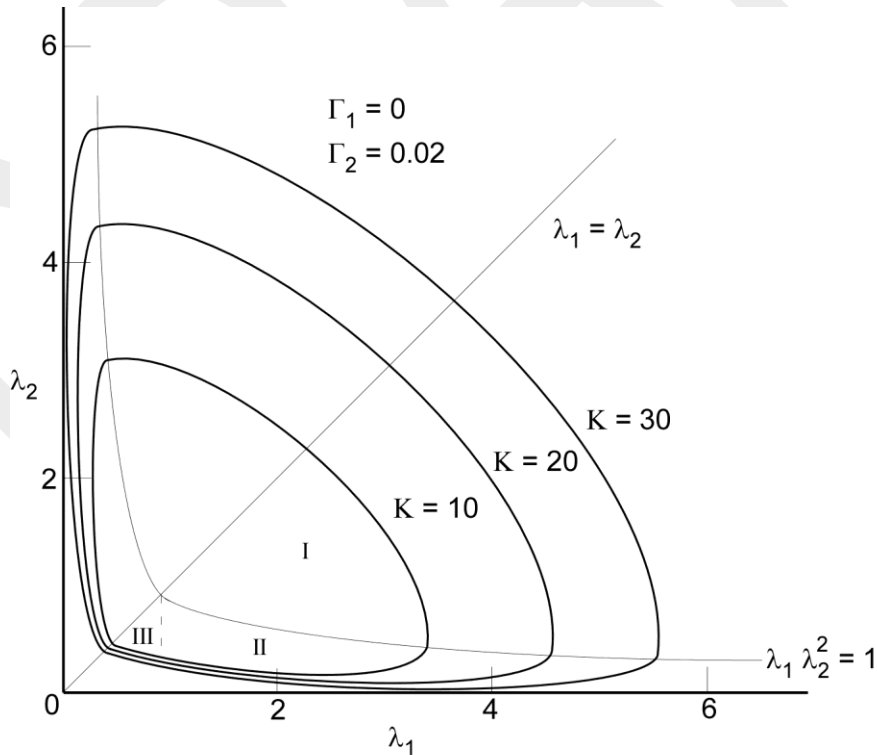

**Figure 181.1.** Failure surface for polymer.

# \*MAT\_183

# \*MAT\_SIMPLIFIED\_RUBBER\_WITH\_DAMAGE

## \*MAT\_SIMPLIFIED\_RUBBER\_WITH\_DAMAGE

This is Material Type 183. This material model provides an incompressible rubber model defined by a single uniaxial load curve for loading (or a table if rate effects are considered) and a single uniaxial load curve for unloading. This model is similar to \*MAT\_SIMPLIFIED\_RUBBER/FOAM This material may be used with both shell and solid elements.

This material law has been developed at DaimlerChrysler, Sindelfingen, in collaboration with Paul Du Bois, LSTC, and Prof. Dave J. Benson, UCSD.

Card 1            1            2            3            4            5            6            7            8

Variable	MID	RO	K	MU	G	SIGF		
Type	A8	F	F	F	F	F		

Card 2            1            2            3            4            5            6            7            8

Variable	SGL	SW	ST	LC/TBID	TENSION	RTYPE	AVGOPT	
Type	F	F	F	F	F	F	F	

Card 3            1            2            3            4            5            6            7            8

Variable	LCUNLD	REF						
Type	F	F						

<u>VARIABLE</u>	<u>DESCRIPTION</u>
MID	Material identification. A unique number or label not exceeding 8 characters must be specified.
RO	Mass density
K	Linear bulk modulus.
MU	Damping coefficient.



VARIABLE	DESCRIPTION
G	Shear modulus for frequency independent damping. Frequency independent damping is based of a spring and slider in series. The critical stress for the slider mechanism is SIGF defined below. For the best results, the value of G should be 250-1000 times greater than SIGF.
SIGF	Limit stress for frequency independent, frictional, damping.
SGL	Specimen gauge length
SW	Specimen width
ST	Specimen thickness
LC/TBID	Load curve or table ID, see *DEFINE_TABLE, defining the force versus actual change in the gauge length. If the table definition is used a family of curves are defined for discrete strain rates. The load curves should cover the complete range of expected loading, i.e., the smallest stretch ratio to the largest.
TENSION	Parameter that controls how the rate effects are treated. Applicable to the table definition. EQ.-1.0: rate effects are considered during tension and compression loading, but not during unloading, EQ. 0.0: rate effects are considered for compressive loading only, EQ.1.0: rate effects are treated identically in tension and compression.
RTYPE	Strain rate type if a table is defined: EQ.0.0: true strain rate, EQ.1.0: engineering strain rate
AVGOPT	Averaging option determine strain rate to reduce numerical noise. EQ.0.0: simple average of twelve time steps, EQ.1.0: running 12 point average.
LCUNLD	Load curve, see *DEFINE_CURVE, defining the force versus actual change in the gauge length during unloading. The unload curve should cover exactly the same range as LC (or as the first curve of table TBID) and its end points should have identical values, i.e., the combination of LC (or as the first curve of table TBID) and LCUNLD describes a complete cycle of loading and unloading.

---

<u>VARIABLE</u>	<u>DESCRIPTION</u>
REF	Use reference geometry to initialize the stress tensor. The reference geometry is defined by the keyword: <b>*INITIAL_FOAM_REFERENCE_GEOMETRY</b> (see there for more details). EQ.0.0: off, EQ.1.0: on.



\*MAT\_COHESIVE\_ELASTIC

This is Material Type 184. It is a simple cohesive elastic model for use with solid element types 19 and 20, and is not available for other solid element formulation. See the remarks after \*SECTION\_SOLID for a description of element types 19 and 20.

Card 1            1            2            3            4            5            6            7            8

Variable	MID	RO	ROFLG	INTFAIL	ET	EN	FN_FAIL	
Type	A8	F	F	F	F	F	F	

<u>VARIABLE</u>	<u>DESCRIPTION</u>
MID	Material identification. A unique number or label not exceeding 8 characters must be specified.
RO	Mass density
ROFLG	Flag for whether density is specified per unit area or volume. ROFLG=0 specified density per unit volume (default), and ROFLG=1 specifies the density is per unit area for controlling the mass of cohesive elements with an initial volume of zero.
INTFAIL	The number of integration points required for the cohesive element to be deleted. If it is zero, the element won't be deleted even if it satisfies the failure criterion. The value of INTFAIL may range from 1 to 4, with 1 the recommended value.
ET	The stiffness in the plane of the cohesive element.
EN	The stiffness normal to the plane of the cohesive element.
FN_FAIL	The traction in the normal direction for tensile failure.

**Remarks:**

This material cohesive model outputs three tractions having units of force per unit area into the D3PLOT database rather than the usual six stress components. The in plane shear traction along the 1-2 edge replaces the x-stress, the orthogonal in plane shear traction replaces the y-stress, and the traction in the normal direction replaces the z-stress.

**\*MAT\_COHESIVE\_TH**

This is Material Type 185. It is a cohesive model by Tvergaard and Hutchinson [1992] for use with solid element types 19 and 20, and is not available for any other solid element formulation. See the remarks after \*SECTION\_SOLID for a description of element types 19 and 20. The implementation is based on the description of the implementation in the Sandia National Laboratory code, Tahoe [2003].

Card 1            1            2            3            4            5            6            7            8

Variable	MID	RO	ROFLG	INTFAIL	SIGMAX	NLS	TLS	
Type	A8	F	F	F	F	F	F	

Card 2            1            2            3            4            5            6            7            8

Variable	LAMDA1	LAMDA2	LAMDAF	STFSF				
Type	F	F	F	F				

<u>VARIABLE</u>	<u>DESCRIPTION</u>
MID	Material identification. A unique number or label not exceeding 8 characters must be specified.
RO	Mass density
ROFLG	Flag for whether density is specified per unit area or volume. ROFLG=0 specified density per unit volume (default), and ROFLG=1 specifies the density is per unit area for controlling the mass of cohesive elements with an initial volume of zero.
INTFAIL	The number of integration points required for the cohesive element to be deleted. If it is zero, the element won't be deleted even if it satisfies the failure criterion. The value of INTFAIL may range from 1 to 4, with 1 the recommended value.
SIGMAX	Peak traction.
NLS	Length scale (maximum separation) in the normal direction.
TLS	Length scale (maximum separation) in the tangential direction.

VARIABLE	DESCRIPTION
LAMDA1	Scaled distance to peak traction ( $\Lambda_1$ ).
LAMDA2	Scaled distance to beginning of softening ( $\Lambda_2$ ).
LAMDAF	Scaled distance for failure ( $\Lambda_{fail}$ ).
STFSF	Penetration stiffness multiplier. The penetration stiffness, $PS$ , in terms of input parameters becomes:

$$PS = \frac{STFSF * SIGMAX}{NLS * \left( \frac{LAMDA1}{LAMDFAF} \right)}$$

### Remarks:

In this cohesive material model, a dimensionless separation measure  $\lambda$  is used, which grasps for the interaction between relative displacements in normal ( $\delta_3$  - mode I) and tangential ( $\delta_1, \delta_2$  - mode II) directions (see Figure 185.1 left):

$$\lambda = \sqrt{\left( \frac{\delta_1}{TLS} \right)^2 + \left( \frac{\delta_2}{TLS} \right)^2 + \left( \frac{\langle \delta_3 \rangle}{NLS} \right)^2}$$

where the Mc-Cauley bracket is used to distinguish between tension ( $\delta_3 \geq 0$ ) and compression ( $\delta_3 < 0$ ).  $NLS$  and  $TLS$  are critical values, representing the maximum separations in the interface in normal and tangential direction. For stress calculation, a trilinear traction-separation law is used, which is given by (see Figure 185.1 right):

$$t(\lambda) = \begin{cases} \sigma_{max} \frac{\lambda}{\Lambda_1/\Lambda_{fail}} & : \lambda < \Lambda_1/\Lambda_{fail} \\ \sigma_{max} & : \Lambda_1/\Lambda_{fail} < \lambda < \Lambda_2/\Lambda_{fail} \\ \sigma_{max} \frac{1-\lambda}{1-\Lambda_2/\Lambda_{fail}} & : \Lambda_2/\Lambda_{fail} < \lambda < 1 \end{cases}$$

With these definitions, the traction drops to zero when  $\lambda = 1$ . Then, a potential  $\phi$  is defined as:

$$\phi(\delta_1, \delta_2, \delta_3) = NLS \cdot \int_0^\lambda t(\bar{\lambda}) d\bar{\lambda}$$

Finally, tangential components ( $t_1, t_2$ ) and normal component ( $t_3$ ) of the traction acting on the interface in the fracture process zone are given by:

$$t_{1,2} = \frac{\partial \phi}{\partial \delta_{1,2}} = \frac{t(\lambda)}{\lambda} \frac{\delta_{1,2}}{TLS} \frac{NLS}{TLS}, \quad t_3 = \frac{\partial \phi}{\partial \delta_3} = \frac{t(\lambda)}{\lambda} \frac{\delta_3}{NLS}$$

which in matrix notation is

$$\begin{bmatrix} t_1 \\ t_2 \\ t_3 \end{bmatrix} = \frac{t(\lambda)}{\lambda} \begin{bmatrix} \frac{NLS}{TLS^2} & 0 & 0 \\ 0 & \frac{NLS}{TLS^2} & 0 \\ 0 & 0 & \frac{1}{NLS} \end{bmatrix} \begin{bmatrix} \delta_1 \\ \delta_2 \\ \delta_3 \end{bmatrix}$$

In case of compression ( $\delta_3 < 0$ ), penetration is avoided by:

$$t_3 = \frac{STFSF \cdot \sigma_{max}}{NLS \cdot \Lambda_1 / \Lambda_{fail}} \delta_3$$

Loading and unloading follows the same path, i.e. this model is completely reversible.

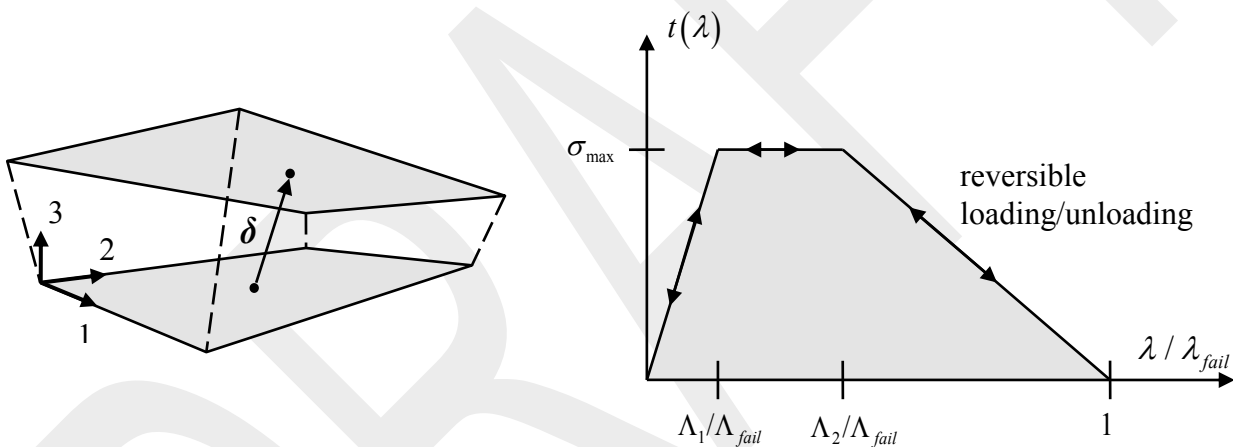

**Figure 185.1.** Relative displacement and trilinear traction-separation law.

This cohesive material model outputs three tractions having units of force per unit area into the D3PLOT database rather than the usual six stress components. The in plane shear traction  $t_1$  along the 1-2 edge replaces the x-stress, the orthogonal in plane shear traction  $t_2$  replaces the y-stress, and the traction in the normal direction  $t_3$  replaces the z-stress.

\*MAT\_COHESIVE\_GENERAL

This is Material Type 186. This model includes three general irreversible mixed-mode interaction cohesive formulations with arbitrary normalized traction-separation law given by a load curve (TSLC). These three formulations are differentiated via the type of effective separation parameter (TES). The interaction between fracture modes I and II is considered, and irreversible conditions are enforced via a damage formulation (unloading/reloading path pointing to/from the origin). See remarks for details.

Card 1            1            2            3            4            5            6            7            8

Variable	MID	RO	ROFLG	INTFAIL	TES	TSLC	GIC	GIIC
Type	A8	F	F	F	F	F	F	F

Card 2            1            2            3            4            5            6            7            8

Variable	XMU	T	S	STFSF				
Type	F	F	F	F				

<u>VARIABLE</u>	<u>DESCRIPTION</u>
MID	Material identification. A unique number or label not exceeding 8 characters must be specified.
RO	Mass density.
ROFLG	Flag for whether density is specified per unit area or volume. ROFLG=0 specifies density per unit volume (default), and ROFLG=1 specifies the density is per unit area for controlling the mass of cohesive elements with an initial volume of zero.
INTFAIL	Number of integration points required for a cohesive element to be deleted. If it is zero, the element won't be deleted even if it satisfies failure criterion. The value of INTFAIL may range from 1 to 4, with 1 the recommended value.

VARIABLE	DESCRIPTION
TES	Type of effective separation parameter (ESP). EQ. 0.0 or 1.0: a dimensional separation measure is used. For the interaction between mode I and II, a mixed-mode propagation criterion is used. For TES=0.0 this is a power-law, and for TES=1.0 this is the Benzeggagh-Kenane law [1996]. See remarks below. EQ. 2.0: a dimensionless separation measure is used, which grasps for the interaction between mode I displacements and mode II displacements (similar to MAT_185, but with damage and general traction-separation law). See remarks below.
TSLC	Normalized traction-separation load curve ID. The curve must be normalized in both coordinates and must contain at least three points: (0.0, 0.0), ( $\lambda_0$ , 1.0), and (1.0, 0.0), which represents the origin, the peak and the complete failure, respectively (see Figure 186.1). A platform can exist in the curve like the tri-linear TSLC (see MAT_185).
GIC	Fracture toughness / energy release rate $G_I^c$ for mode I
GIIC	Fracture toughness / energy release rate $G_{II}^c$ for mode II
XMU	Exponent that appears in the power failure criterion (TES=1.0) or the Benzeggagh-Kenane failure criterion (TES=2.0). Recommended values for XMU are between 1.0 and 2.0.
T	Peak traction in normal direction (mode I)
S	Peak traction in tangential direction (mode II)
STFSF	Penetration stiffness multiplier for compression. Factor = (1.0+STFSF) is used to scale the compressive stiffness, i.e. no scaling is done with STFSF=0.0 (recommended).

**Remarks:**

All three formulations have in common, that the traction-separation behavior of this model is mainly given by  $G_I^c$  and  $T$  for normal mode I,  $G_{II}^c$  and  $S$  for tangential mode II and an arbitrary normalized traction-separation load curve for both modes (see Figure 186.1). The maximum (or failure) separations are then given by:

$$\delta_I^F = \frac{G_I^c}{A_{TSLC} \cdot T}, \quad \delta_{II}^F = \frac{G_{II}^c}{A_{TSLC} \cdot S}$$

where  $A_{TSLC}$  is the area under the normalized traction-separation curve.



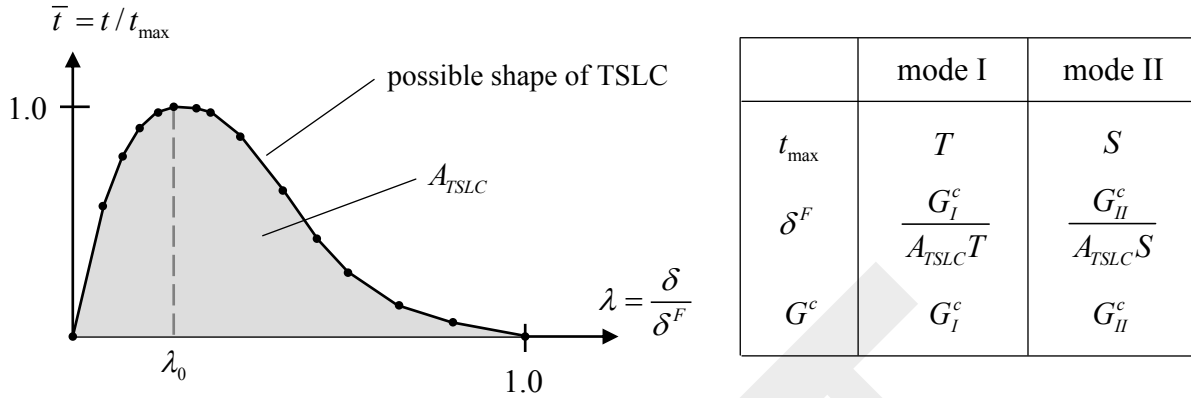

**Figure 186.1.** Normalized traction-separation law

For mixed-mode behavior, three different formulations are possible (where default TES=0.0 with XMU=1.0 is recommended as first guess):

**First and second formulation (TES=0.0 and TES=1.0)**

Here, the total mixed-mode relative displacement  $\delta_m$  is defined as  $\delta_m = \sqrt{\delta_I^2 + \delta_{II}^2}$ , where  $\delta_I = \delta_3$  is the separation in normal direction (mode I) and  $\delta_{II} = \sqrt{\delta_1^2 + \delta_2^2}$  is the separation in tangential direction (mode II) (see Figure 186.2). The ultimate mixed-mode displacement  $\delta^F$  (total failure) for the power law (TES=0.0) is:

$$\delta^F = \frac{1 + \beta^2}{A_{TSLC}} \left[ \left( \frac{T}{G_I^c} \right)^{XMU} + \left( \frac{S \cdot \beta^2}{G_{II}^c} \right)^{XMU} \right]^{\frac{1}{XMU}}$$

and alternatively for the Benzeggagh-Kenane law [1996] (TES=1.0):

$$\delta^F = \frac{1 + \beta^2}{A_{TSLC}(T + \beta^2 S)} \left[ G_I^c + (G_{II}^c - G_I^c) \left( \frac{\beta^2 \cdot S}{T + \beta^2 \cdot S} \right)^{XMU} \right]$$

where  $\beta = \delta_{II} / \delta_I$  is the “mode mixity”. The larger the exponent XMU is chosen, the larger the fracture toughness in mixed-mode situations will be. In this model, damage of the interface is considered, i.e. irreversible conditions are enforced with loading/unloading paths coming from/pointing to the origin. This formulation is similar to MAT\_COHESIVE\_MIXED\_MODE (MAT\_138), but with the arbitrary traction-separation law TSLC.

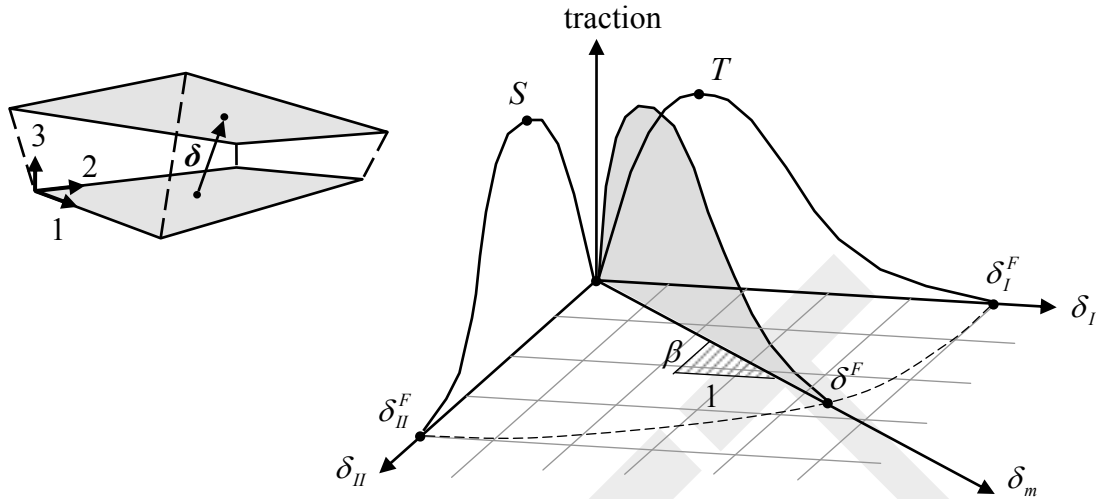

Figure 186.2. Mixed-mode traction-separation law

**Third formulation (TES=2.0)**

Here, a dimensionless effective separation parameter  $\lambda$  is used, which grasps for the interaction between relative displacements in normal ( $\delta_3$  - mode I) and tangential ( $\delta_1, \delta_2$  - mode II) directions:

$$\lambda = \sqrt{\left\langle \frac{\delta_1}{\delta_{II}^F} \right\rangle^2 + \left\langle \frac{\delta_2}{\delta_{II}^F} \right\rangle^2 + \left\langle \frac{\delta_3}{\delta_I^F} \right\rangle^2}$$

where the Mc-Cauley bracket is used to distinguish between tension ( $\delta_3 \geq 0$ ) and compression ( $\delta_3 < 0$ ).  $\delta_I^F$  and  $\delta_{II}^F$  are critical values, representing the maximum separations in the interface in normal and tangential direction. For stress calculation, the normalized traction-separation load curve TSLC is used:  $t = t_{max} \cdot \bar{t}(\lambda)$ . This formulation is similar to MAT\_COHESIVE\_TH (MAT\_185), but with the arbitrary traction-separation law and a damage formulation (i.e. irreversible conditions are enforced with loading/unloading paths coming from/pointing to the origin).

\*MAT\_SAMP-1

Purpose: This is Material Type 187 (Semi-Analytical Model for Polymers). This material model uses an isotropic C-1 smooth yield surface for the description of non-reinforced plastics. Details of the implementation are given in [Kolling, Haufe, Feucht and Du Bois 2005].

This material law has been developed at DaimlerChrysler, Sindelfingen, in collaboration with Paul Du Bois and Dynamore, Stuttgart.

Card 1            1            2            3            4            5            6            7            8

Variable	MID	RO	BULK	GMOD	EMOD	NUE	RBCFAC	NUMINT
Type	A8	F	F	F	F	F	F	

Card 2            1            2            3            4            5            6            7            8

Variable	LCID-T	LCID-C	LCID-S	LCID-B	NUEP	LCID-P		INCDAM
Type	I	I	I	I	F	I		

Card 3            1            2            3            4            5            6            7            8

Variable	LCID-D	EPFAIL	DEPRPT	LCID_TRI	LCID_LC			
Type	I	F	F	I	I			

Card 4            1            2            3            4            5            6            7            8

Variable	MITER	MIPS		INCFAIL	ICONV	ASAF		
Type	I	I		I	I	F		

<b>VARIABLE</b>	<b>DESCRIPTION</b>
MID	Material identification. A unique number or label not exceeding 8 characters must be specified.
RO	Mass density
BULK	Bulk modulus, used by LS-DYNA in the time step calculation
GMOD	Shear modulus, used by LS-DYNA in the time step calculation
EMOD	Young's modulus
NUE	Poisson ratio
RBCFAC	Ratio of yield in biaxial compression vs. yield in uniaxial compression. If nonzero this will activate the use of a multi-linear yield surface. Default is 0.
NUMINT	Number of integration points which must fail before the element is deleted. This option is available for shells and solids. LT.0.0:  NUMINT  is percentage of integration points/layers which must fail before shell element fails. For fully integrated shells, a methodology is used where a layer fails if one integration point fails and then the given percentage of layers must fail before the element fails. Only available for shells.
LCID-T	Load curve or table ID giving the yield stress as a function of plastic strain, these curves should be obtained from quasi-static and (optionally) dynamic uniaxial tensile tests, this input is mandatory and the material model will not work unless at least one tensile stress-strain curve is given.
LCID-C	Load curve ID giving the yield stress as a function of plastic strain, this curve should be obtained from a quasi-static uniaxial compression test, this input is optional.
LCID-S	Load curve ID giving the yield stress as a function of plastic strain, this curve should be obtained from a quasi-static shear test, this input is optional.
LCID-B	Load curve ID giving the yield stress as a function of plastic strain, this curve should be obtained from a quasi-static biaxial tensile test, this input is optional.
NUEP	Plastic Poisson's ratio: an estimated ratio of transversal to longitudinal plastic rate of deformation under uniaxial loading should be given.

VARIABLE	DESCRIPTION
LCID-P	Load curve ID giving the plastic Poisson ratio as a function of equivalent plastic deformation during uniaxial tensile and compressive testing. Abcissa should be negative for plastic strains in compression and positive for plastic strains in tension, it is important to cover both tension and compression. If the load curve is given, the constant value in the previous field will be ignored. This input is optional.
INCDAM	Flag to control the damage evolution as a function of triaxiality. If INCDAM=0 damage evolution is independent of the triaxiality. If INCDAM=1 an incremental formulation is used to compute the damage.
LCID-D	Load curve ID giving the damage parameter as a function of equivalent plastic strain during uniaxial tensile testing. By default this option assumes that effective (i.e. undamaged) yield values are used in the load curves LCID-T, LCID-C, LCID-S and LCID-B. If LCID-D is given a negative value, true (i.e. damaged) yield stress values can be used. In this case an automatic stress-strain recalibration (ASSR) algorithm is activated. The damage value must be defined in the range $0 \leq d < 1$ .
EPFAIL	This parameter is the equivalent plastic strain at failure. If EPFAIL is given as a negative integer, a load curve is expected that defines EPFAIL as a function of the plastic strain rate. Default value is $1.0e+5$
DEPRPT	Increment of equivalent plastic strain between failure point and rupture point. Stresses will fade out to zero between EPFAIL and EPFAIL+DEPRPT. If DEPRPT is given a negative value a curve definition is expected where DEPRPT is defined as function of the triaxiality.
LCID_TRI	Load curve that specifies a factor that works multiplicatively on the value of EPFAIL depending on the triaxiality (i.e. pressure/sigma_vm). For a triaxiality of -1/3 a value of 1.0 should be specified.
LCID_LC	Load curve that specifies a factor that works multiplicatively on the value of EPFAIL depending on a characteristic element length.
MITER	Maximum number of iterations in the cutting plane algorithm, default is set to 400
MIPS	Maximum number of iterations in the secant iteration performed to enforce plane stress (shell elements only), default set to 10
INCFAIL	Flag to control the failure evolution as a function of triaxiality. If INCFAIL=0 failure evolution is independent of the triaxiality. If INCFAIL=1 an incremental formulation is used to compute the failure value. If INCFAIL=-1 the failure model is deactivated.

VARIABLE	DESCRIPTION
ICONV	Formulation flag: ICONV=0: default ICONV=1: yield surface is internally modified by increasing the shear yield until a convex yield surface is achieved.
ASAF	Safety factor, used only if ICONV=1, values between 1 and 2 can improve convergence, however the shear yield will be artificially increased if this option is used, default is set to 1.

**Remarks:**

1. Material SAMP-1 uses three yield curves internally, hence the yield surface has a quadratic shape in general. If less than three curves are defined the remaining curves are generated internally as follows:

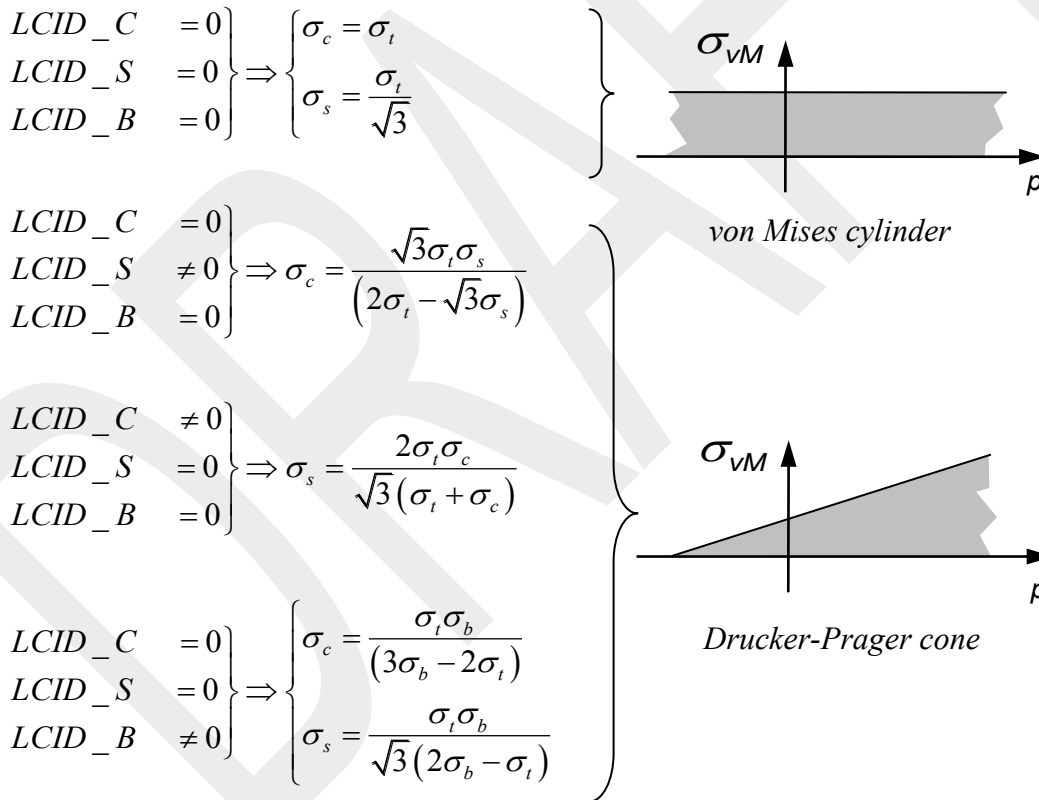

A linear yield surface in the invariant space spanned by the pressure and the von Mises stress is generated using the available data points.

If more than 2 load curves are available the following cases can be distinguished:

$$\left. \begin{aligned} LCID\_S &\neq 0 &\Rightarrow SAMP-1 \\ LCID\_B &= 0 \end{aligned} \right\}$$

$$\left. \begin{aligned} LCID\_C &\neq 0 \\ LCID\_S &= 0 \\ LCID\_B &\neq 0 \end{aligned} \right\} \Rightarrow \sigma_s \frac{1}{\sqrt{3}} \sqrt{\frac{3\sigma_b^2 \sigma_c \sigma_t}{(2\sigma_b + \sigma_c)(2\sigma_b - \sigma_t)}}$$

$$\left. \begin{aligned} LCID\_C &= 0 \\ LCID\_S &\neq 0 \\ LCID\_B &\neq 0 \end{aligned} \right\} \Rightarrow \sigma_c = \frac{6(162\sigma_b^2 \sigma_s^2 + \sigma_b \sigma_s^2 \sigma_t)}{6\sigma_b \sigma_s^2 + 323\sigma_b^2 \sigma_t + 3\sigma_s^2 \sigma_t}$$

$$\left. \begin{aligned} LCID\_C &\neq 0 \\ LCID\_S &\neq 0 \\ LCID\_B &\neq 0 \end{aligned} \right\} \Rightarrow \text{least squares}$$

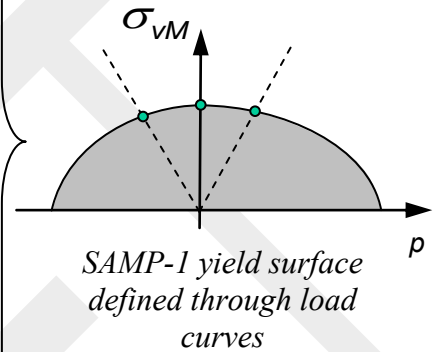

2. If the LCID\_D is given, then a damage curve as a function of equivalent plastic strains acting on the stresses is defined as depicted in the following picture. EPFAIL and DEPRPT defined the failure and fading behaviour of a single element:

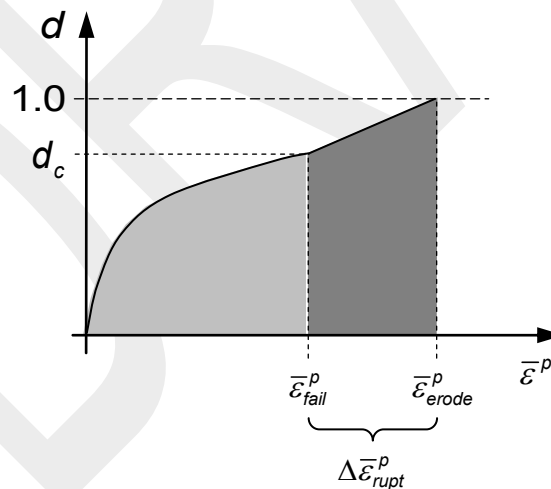
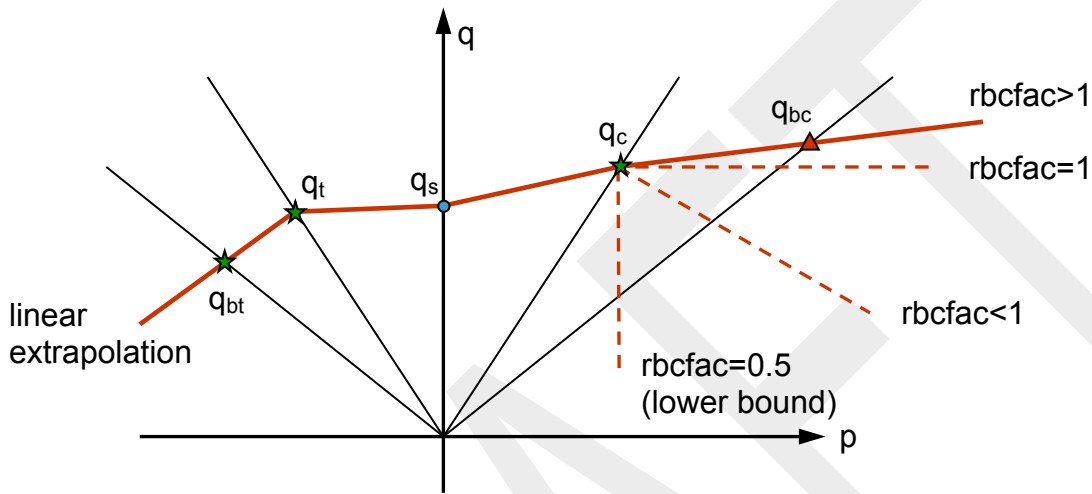

Figure 187.1

Since the damaging curve acts on the yield values, the inelastic results are effected by the damage curve. As a means to circumvent this, the load curve LCID-D may be given a negative ID. This will lead to an internal conversion of from nominal to effective stresses (ASSR).

3. Since the generality of arbitrary curve inputs allows to generate unsolvable yield surfaces, SAMP may modify curves internally. This will always lead to warning messages at the beginning of the simulation run. One modification that is not allowed are negative tangents of the last two data points of any of the yield curves.

4. If RBCFAC is nonzero the yield surface in  $I_1$ - $\sigma_{vm}$ -stress space is constructed such, that a multi-linear yield surface is gained. RBCFAC allows to modify then behavior in biaxial compression.



q	von Mises stress
p	pressure
★	required input data
●	optional input data
▲	extrapolated data

bt	biaxial tension
t	tension
s	shear
c	compression
bc	biaxial

$$rbcfac = \frac{q_{bc}}{q_c}$$



\*MAT\_THERMO\_ELASTO\_VISCOPLASTIC\_CREEP

This is Material Type 188. In this model, creep is described separately from plasticity using Garafalo’s steady-state hyperbolic sine creep law or Norton’s power law. Viscous effects of plastic strain rate are considered using the Cowper-Symonds model. Young’s modulus, Poisson’s ratio, thermal expansion coefficient, yield stress, material parameters of Cowper-Symonds model as well as the isotropic and kinematic hardening parameters are all assumed to be temperature dependent. Application scope includes: simulation of solder joints in electronic packaging, modeling of tube brazing process, creep age forming, etc.

Card 1            1            2            3            4            5            6            7            8

Variable	MID	RO	E	PR	SIGY	ALPHA	LCSS	REFTEM
Type	A8	F	F	F	F	F	F	F

Card 2            1            2            3            4            5            6            7            8

Variable	QR1	CR1	QR2	CR2	QX1	CX1	QX2	CX2
Type	F	F	F	F	F	F	F	F

Card 3            1            2            3            4            5            6            7            8

Variable	C	P	LCE	LCPR	LCSIGY	LCQR	LCQX	LCALPH
Type	F	F	F	F	F	F	F	F

Card 4            1            2            3            4            5            6            7            8

Variable	LCC	LCP	LCCR	LCCX	CRPA	CRPB	CRPQ	CRPM
Type	F	F	F	F	F	F	F	F

**Optional card 5**

Card 5            1            2            3            4            5            6            7            8

Variable	CRPLAW							
Type	F							

<u>VARIABLE</u>	<u>DESCRIPTION</u>
MID	Material identification. A unique number or label not exceeding 8 characters must be specified.
RO	Mass density.
E	Young's modulus
PR	Poisson's ratio
SIGY	Initial yield stress
ALPHA	Thermal expansion coefficient
LCSS	Load curve ID or Table ID. The load curve ID defines effective stress versus effective plastic strain. The table ID defines for each temperature value a load curve ID giving the stress versus effective plastic strain for that rate. The stress versus effective plastic strain curve for the lowest value of temperature is used if the temperature falls below the minimum value. Likewise, the stress versus effective plastic strain curve for the highest value of temperature is used if the temperature exceeds the maximum value. Card 2 is ignored with this option.
REFTEM	Reference temperature that defines thermal expansion coefficient
QR1	Isotropic hardening parameter $Q_{r1}$
CR1	Isotropic hardening parameter $C_{r1}$
QR2	Isotropic hardening parameter $Q_{r2}$
CR2	Isotropic hardening parameter $C_{r2}$
QX1	Kinematic hardening parameter $Q_{\chi1}$
CX1	Kinematic hardening parameter $C_{\chi1}$

VARIABLE	DESCRIPTION
QX2	Kinematic hardening parameter $Q_{\chi 2}$
CX2	Kinematic hardening parameter $C_{\chi 2}$
C	Viscous material parameter $C$
P	Viscous material parameter $P$
LCE	Load curve for scaling Young's modulus as a function of temperature
LCPR	Load curve for scaling Poisson's ratio as a function of temperature
LCSIGY	Load curve for scaling initial yield stress as a function of temperature
LCQR	Load curve for scaling the isotropic hardening parameters QR1 and QR2 or the stress given by the load curve LCSS as a function of temperature
LCQX	Load curve for scaling the kinematic hardening parameters QX1 and QX2 as a function of temperature
LCALPH	Load curve for scaling the thermal expansion coefficient as a function of temperature
LCC	Load curve for scaling the viscous material parameter C as a function of temperature
LCP	Load curve for scaling the viscous material parameter P as a function of temperature
LCCR	Load curve for scaling the isotropic hardening parameters CR1 and CR2 as a function of temperature
LCCX	Load curve for scaling the isotropic hardening parameters CX1 and CX2 as a function of temperature
CRPA	Creep law parameter A GT.0.0: Constant value LT.0.0: Load curve ID = (-CRPA) which defines A as a function of temperature.
CRPB	Creep law parameter B GT.0.0: Constant value LT.0.0: Load curve ID = (-CRPB) which defines B as a function of temperature.

VARIABLE	DESCRIPTION
CRPQ	Creep law parameter Q GT.0.0: Constant value LT.0.0: Load curve ID = (-CRPQ) which defines Q as a function of temperature.
CRPM	Creep law parameter m GT.0.0: Constant value LT.0.0: Load curve ID = (-CRPM) which defines m as a function of temperature.
CRPLAW	Creep law definition (see Remarks): EQ.0.0: Garofalo's hyperbolic sine law (default). EQ.1.0: Norton's power law.

**Remarks:**

If LCSS is not given any value the uniaxial stress-strain curve has the form

$$\sigma(\epsilon_{eff}^p) = \sigma_0 + Q_{r1}(1 - \exp(-C_{r1}\epsilon_{eff}^p)) + Q_{r2}(1 - \exp(-C_{r2}\epsilon_{eff}^p)) + Q_{\chi1}(1 - \exp(-C_{\chi1}\epsilon_{eff}^p)) + Q_{\chi2}(1 - \exp(-C_{\chi2}\epsilon_{eff}^p))$$

Viscous effects are accounted for using the Cowper-Symonds model, which scales the yield stress with the factor:

$$1 + \left( \frac{\dot{\epsilon}_{eff}^p}{C} \right)^{1/p}$$

For CRPLAW=0, the steady-state creep strain rate of Garafalo's hyperbolic sine equation is given by

$$\dot{\epsilon}^c = A \left[ \sinh(B\tau^e) \right]^m \exp\left(-\frac{Q}{T}\right)$$

For CRPLAW=1, the steady-state creep strain rate is given by Norton's power law equation:

$$\dot{\epsilon}^c = A(\tau^e)^B t^m$$

\*MAT\_ANISOTROPIC\_THERMOELASTIC

This is Material Type 189. This model characterizes elastic materials whose elastic properties are temperature-dependent.

Card 1            1            2            3            4            5            6            7            8

Variable	MID	RO	TA1	TA2	TA3	TA4	TA5	TA6
Type	A8	F	F	F	F	F	F	F

Card 2            1            2            3            4            5            6            7            8

Variable	C11	C12	C13	C14	C15	C16	C22	C23
Type	F	F	F	F	F	F	F	F

Card 3            1            2            3            4            5            6            7            8

Variable	C24	C25	C26	C33	C34	C35	C36	C44
Type	F	F	F	F	F	F	F	F

Card 4            1            2            3            4            5            6            7            8

Variable	C45	C46	C55	C56	C66	TGE	TREF	AOPT
Type	F	F	F	F	F	F	F	F

Card 5            1            2            3            4            5            6            7            8

Variable	XP	YP	ZP	A1	A2	A3	MACF	
Type	F	F	F	F	F	F	F	

Card 6            1            2            3            4            5            6            7            8

Variable	V1	V2	V3	D1	D2	D3	BETA	REF
Type	F	F	F	F	F	F	F	F

**VARIABLE****DESCRIPTION**

MID	Material identification. A unique number or label not exceeding 8 characters must be specified.
RO	Mass density.
TAi	Curve IDs defining the coefficients of thermal expansion for the six components of strain tensor as function of temperature.
CIJ	Curve IDs defining the 6×6 symmetric constitutive matrix in material coordinate system as function of temperature. Note that 1 corresponds to the <i>a</i> material direction, 2 to the <i>b</i> material direction, and 3 to the <i>c</i> material direction.
TGE	Curve ID defining the structural damping coefficient as function of temperature.
TREF	Reference temperature for the calculation of thermal loads or the definition of thermal expansion coefficients.

VARIABLE	DESCRIPTION
AOPT	<p>Material axes option, (see MAT_ANISOTROPIC_ELASTIC/MAT_002 for a complete description.)</p> <p>EQ.0.0: locally orthotropic with material axes determined by element nodes 1, 2, and 4, as with *DEFINE_COORDINATE_NODES.</p> <p>EQ.1.0: locally orthotropic with material axes determined by a point in space and the global location of the element center; this is the a-direction.</p> <p>EQ.2.0: globally orthotropic with material axes determined by vectors defined below, as with *DEFINE_COORDINATE_VECTOR.</p> <p>EQ.3.0: locally orthotropic material axes determined by rotating the material axes about the element normal by an angle, BETA, from a line in the plane of the element defined by the cross product of the vector <b>v</b> with the element normal.</p> <p>EQ.4.0: locally orthotropic in cylindrical coordinate system with the material axes determined by a vector <b>v</b>, and an originating point, P, which define the centerline axis.</p> <p>LT.0.0: the absolute value of AOPT is a coordinate system ID number (CID on *DEFINE_COORDINATE_NODES, *DEFINE_COORDINATE_SYSTEM or *DEFINE_COORDINATE_VECTOR). Available in R3 version of 971 and later.</p>
XP, YP, ZP	XP, YP, ZP define coordinates of point <b>p</b> for AOPT=1 and 4.
A1, A2, A3	a1, a2, a3 define components of vector <b>a</b> for AOPT=2.
MACF	Material axis change flag for brick elements (see MAT_002 for a complete description.)
D1, D2, D3	d1, d2, d3 define components of vector <b>d</b> for AOPT=2.
V1, V2, V3	v1, v2, v3 define components of vector <b>v</b> for AOPT=3 and 4.
BETA	Material angle in degrees for AOPT=3, may be overwritten on the element card, see *ELEMENT_SOLID_ORTHO.
REF	Use initial geometry to initialize the stress tensor (see MAT_002 for a complete description.)

**\*MAT\_FLD\_3-PARAMETER\_BARLAT**

This is Material Type 190. This model was developed by Barlat and Lian [1989] for modeling sheets with anisotropic materials under plane stress conditions. This material allows the use of the Lankford parameters for the definition of the anisotropy. This particular development is due to Barlat and Lian [1989]. It has been modified to include a failure criterion based on the Forming Limit Diagram. The curve can be input as a load curve, or calculated based on the n-value and sheet thickness.

Card 1            1            2            3            4            5            6            7            8

Variable	MID	RO	E	PR	HR	P1	P2	ITER
Type	A8	F	F	F	F	F	F	F

Card 2            1            2            3            4            5            6            7            8

Variable	M	R00	R45	R90	LCID	E0	SPI	P3
Type	F	F	F	F	I	F	F	F

Card 3            1            2            3            4            5            6            7            8

Variable	AOPT	C	P	FLDCID	RN	RT	FLDSAFE	FLDNIPF
Type	F	F	F	I	F	F	F	I

Card 4            1            2            3            4            5            6            7            8

Variable				A1	A2	A3		
Type				F	F	F		



Card 5            1            2            3            4            5            6            7            8

Variable	V1	V2	V3	D1	D2	D3	BETA	
Type	F	F	F	F	F	F	F	

<u>VARIABLE</u>	<u>DESCRIPTION</u>
MID	Material identification. A unique number or label not exceeding 8 characters must be specified.
RO	Mass density.
E	Young's modulus, E
PR	Poisson's ratio, $\nu$
HR	Hardening rule: EQ.1.0: linear (default), EQ.2.0: exponential (Swift) EQ.3.0: load curve EQ.4.0: exponential (Voce) EQ.5.0: exponential (Gosh) EQ.6.0: exponential (Hocket-Sherby)
P1	Material parameter: HR.EQ.1.0: Tangent modulus, HR.EQ.2.0: k, strength coefficient for Swift exponential hardening HR.EQ.4.0: a, coefficient for Voce exponential hardening HR.EQ.5.0: k, strength coefficient for Gosh exponential hardening HR.EQ.6.0: a, coefficient for Hocket-Sherby exponential hardening
P2	Material parameter: HR.EQ.1.0: Yield stress HR.EQ.2.0: n, exponent for Swift exponential hardening HR.EQ.4.0: c, coefficient for Voce exponential hardening HR.EQ.5.0: n, exponent for Gosh exponential hardening HR.EQ.6.0: c, coefficient for Hocket-Sherby exponential hardening
ITER	Iteration flag for speed: ITER.EQ.0.0: fully iterative ITER.EQ.1.0: fixed at three iterations Generally, ITER=0 is recommended. However, ITER=1 is somewhat faster and may give acceptable results in most problems.

VARIABLE	DESCRIPTION
M	m, exponent in Barlat's yield surface
R00	R <sub>00</sub> , Lankford parameter determined from experiments
R45	R <sub>45</sub> , Lankford parameter determined from experiments
R90	R <sub>90</sub> , Lankford parameter determined from experiments
LCID	load curve ID for the load curve hardening rule
E0	Material parameter HR.EQ.2.0: $\epsilon_0$ for determining initial yield stress for Swift exponential hardening. (Default=0.0) HR.EQ.4.0: b, coefficient for Voce exponential hardening HR.EQ.5.0: $\epsilon_0$ for determining initial yield stress for Gosh exponential hardening. (Default=0.0) HR.EQ.6.0: b, coefficient for Hocket-Sherby exponential hardening
SPI	If $\epsilon_0$ is zero above and HR.EQ.2.0. (Default=0.0) EQ.0.0: $\epsilon_0 = (E/k)**[1/(n-1)]$ LE.0.2: $\epsilon_0 = spi$ GT.0.2: $\epsilon_0 = (spi/k)**[1/n]$
P3	Material parameter: HR.EQ.5.0: p, parameter for Gosh exponential hardening HR.EQ.6.0: n, exponent for Hocket-Sherby exponential hardening
AOPT	Material axes option (see MAT_OPTION TROPIC_ELASTIC for a more complete description): EQ.0.0: locally orthotropic with material axes determined by element nodes 1, 2, and 4, as with *DEFINE_COORDINATE_NODES, and then rotated about the shell element normal by the angle BETA. EQ.2.0: globally orthotropic with material axes determined by vectors defined below, as with *DEFINE_COORDINATE_VECTOR. EQ.3.0: locally orthotropic material axes determined by rotating the material axes about the element normal by an angle, BETA, from a line in the plane of the element defined by the cross product of the vector v with the element normal. LT.0.0: the absolute value of AOPT is a coordinate system ID number (CID on *DEFINE_COORDINATE_NODES, *DEFINE_COORDINATE_SYSTEM or *DEFINE_COORDINATE_VECTOR). Available in R3 version of 971 and later.

<u>VARIABLE</u>	<u>DESCRIPTION</u>
C	C in Cowper-Symonds strain rate model
P	p in Cowper-Symonds strain rate model, p=0.0 for no strain rate effects
FLDCID	Load curve ID defining the Forming Limit Diagram. Minor strains in percent are defined as abscissa values and Major strains in percent are defined as ordinate values. The forming limit diagram is shown in Figure 39.1. In defining the curve list pairs of minor and major strains starting with the left most point and ending with the right most point, see *DEFINE_CURVE.
RN	Hardening exponent equivalent to the n-value in a power law hardening law. If the parameter FLDCID is not defined, this value in combination with the value RT can be used to calculate a forming limit curve to allow for failure.
RT	Sheet thickness used for calculating a forming limit curve. This value does not override the sheet thickness in any way. It is only used in conjunction with the parameter RN to calculate a forming limit curve if the parameter FLDCID is not defined.
FLDSAFE	A safety offset of the forming limit curve. This value should be input as a percentage (ex. 10 not 0.10). This safety margin will be applied to the forming limit curve defined by FLDCID or the curve calculated by RN and RT.
FLDNIPF	The number of element integration points that must fail before the element is deleted. By default, if one integration point has strains above the forming limit curve, the element is flagged for deletion.
A1 A2 A3	Components of vector <b>a</b> for AOPT = 2.
V1 V2 V3	Components of vector <b>v</b> for AOPT = 3.
D1 D2 D3	Components of vector <b>d</b> for AOPT = 2.
BETA	Material angle in degrees for AOPT = 0 and 3, may be overridden on the element card, see *ELEMENT_SHELL_BETA.

### **Remarks:**

See material 36 for the theoretical basis.

The forming limit curve can be input directly as a curve by specifying a load curve id with the parameter FLDCID. When defining such a curve, the major and minor strains must be input as percentages.

Alternatively, the parameters RN and RT can be used to calculate a forming limit curve. The use of RN and RT is not recommended for non-ferrous materials. RN and RT are ignored if a non-zero FLDCID is defined.

The first history variable is the maximum strain ratio defined by:

$$\frac{\varepsilon_{major,workpiece}}{\varepsilon_{major,flc}}$$

corresponding to  $\varepsilon_{minor,workpiece}$ . A value between 0 and 1 indicates that the strains lie below the forming limit curve. Values above 1 indicate that the strains are above the forming limit curve.

\*MAT\_SEISMIC\_BEAM

Purpose: This is Material Type 191. This material enables lumped plasticity to be developed at the 'node 2' end of Belytschko-Schwer beams (resultant formulation). The plastic yield surface allows interaction between the two moments and the axial force.

Card 1            1            2            3            4            5            6            7            8

Variable	MID	RO	E	PR	ASFLAG	FTYPE	DEGRAD	IFEMA
Type	A8	F	F	F	F	I	I	I
Default	none	none	none	none	0.0	1	0	0

Card 2            1            2            3            4            5            6            7            8

Variable	LCPMS	SFS	LCPMT	SFT	LCAT	SFAT	LCAC	SFAC
Type	F	F	F	F	F	F	F	F
Default	none	1.0	LCMPS	1.0	none	1.0	LCAT	1.0

**Define the following card for interaction formulation, FTYPE, type 1 (Default)**

Card 3            1            2            3            4            5            6            7            8

Variable	ALPHA	BETA	GAMMA	DELTA	A	B	FOFFS	
Type	F	F	F	F	F	F	F	
Default	see note	see note	see note	see note	see note	see note	0.0	

**Define the following card for interaction formulation, FTYPE, type 2**

Card 3            1            2            3            4            5            6            7            8

Variable	SIGY	D	W	TF	TW			
Type	F	F	F	F	F			
Default	none	none	none	none	none			

**Define the following card for interaction formulation FTYPE, type 4**

Card 3            1            2            3            4            5            6            7            8

Variable	PHI_T	PHI_C	PHI_B					
Type	F	F	F					
Default	0.8	0.85	0.9					

**Define the following card for interaction formulation FTYPE, type 5**

Card 3	1	2	3	4	5	6	7	8
Variable	ALPHA	BETA	GAMMA	DELTA	PHI_T	PHI_C	PHI_B	
Type	F	F	F	F	F	F	F	
Default	none	none	1.4	none	1.0	1.0	1.0	

Define the following card for FEMA limits only if IFEMA > 0

Card 4            1            2            3            4            5            6            7            8

Variable	PR1	PR2	PR3	PR4				
Type	F	F	F	F				
Default	0	0	0	0				

Define the following card for FEMA limits only if IFEMA = 2

Card 5            1            2            3            4            5            6            7            8

Variable	TS1	TS2	TS3	TS4	CS1	CS2	CS3	CS4
Type	F	F	F	F	F	F	F	F
Default	0	0	0	0	TS1	TS2	TS3	TS4

<u>VARIABLE</u>	<u>DESCRIPTION</u>
MID	Material identification. A unique number or label not exceeding 8 characters must be specified.
RO	Mass density.
E	Young's modulus.
PR	Poisson's ratio.
ASFLAG	Axial strain definition for force-strain curves, degradation and FEMA output: EQ. 0.0 true (log) total strain EQ. 1.0 change in length EQ. 2.0 nominal total strain EQ. 3.0 FEMA plastic strain ( = nominal total strain minus elastic strain)

<b>VARIABLE</b>	<b>DESCRIPTION</b>
FTYPE	Formulation type for interaction EQ.1: Parabolic coefficients, axial load and biaxial bending (default). EQ.2: Japanese code, axial force and major axis bending. EQ.4 AISC utilization calculation but no yielding EQ.5 AS4100 utilization calculation but no yielding
DEGRADE	Flag for degrading moment behavior (see Remarks) EQ.0: Behavior as in previous versions EQ.1: Fatigue-type degrading moment-rotation behavior EQ.2: FEMA-type degrading moment-rotation behavior
IFEMA	Flag for input of FEMA thresholds EQ.0: No input EQ.1: Input of rotation thresholds only EQ.2: Input of rotation and axial strain thresholds
LCPMS	Load curve ID giving plastic moment vs. Plastic rotation at node 2 about local s-axis. See *DEFINE_CURVE.
SFS	Scale factor on s-moment at node 2.
LCPMT	Load curve ID giving plastic moment vs. Plastic rotation at node 2 about local t-axis. See *DEFINE_CURVE.
SFT	Scale factor on t-moment at node 2.
LCAT	Load curve ID giving axial tensile yield force vs. total tensile (elastic + plastic) strain or vs. elongation. See AOPT above. All values are positive. See *DEFINE_CURVE.
SFAT	Scale factor on axial tensile force.
LCAC	Load curve ID giving compressive yield force vs. total compressive (elastic + plastic) strain or vs. elongation. See AOPT above. All values are positive. See *DEFINE_CURVE.
SFAC	Scale factor on axial tensile force.
ALPHA	Parameter to define yield surface.
BETA	Parameter to define yield surface.
GAMMA	Parameter to define yield surface.
DELTA	Parameter to define yield surface.



<u>VARIABLE</u>	<u>DESCRIPTION</u>
A	Parameter to define yield surface.
B	Parameter to define yield surface.
FOFFS	Force offset for yield surface (see Remarks).
SIGY	Yield stress of material.
D	Depth of section used to calculate interaction curve.
W	Width of section used to calculate interaction curve.
TF	Flange thickness of section used to calculate interaction curve.
TW	Web thickness used to calculate interaction curve.
PHI_T	Factor on tensile capacity, $\phi_t$
PHI_C	Factor on compression capacity, $\phi_c$
PHI_B	Factor on bending capacity, $\phi_b$
PR1-PR4	Plastic rotation thresholds 1 to 4
TS1-TS4	Tensile axial strain thresholds 1 to 4
CS1-CS4	Compressive axial strain thresholds 1 to 4

**Remarks:**

Yield surface for formulation type 1 is of the form:

$$\psi = \left( \frac{M_s}{M_{ys}} \right)^\alpha + \left( \frac{M_t}{M_{yt}} \right)^\beta + A \left( \frac{F}{F_y} \right)^\gamma + B \left( \frac{F}{F_y} \right)^\delta - 1$$

where:

$M_s$ ,  $M_t$ ,  $F$  are the current moments about local s and t axes and axial force respectively

$M_{ys}$ ,  $M_{yt}$ ,  $F_y$  are the current yield moments and forces;  $F_y$  is taken from LCAC or LCAT as appropriate.

$\alpha$ ,  $\beta$ ,  $\gamma$ ,  $\delta$ ,  $A$ ,  $B$  are input parameters.  $\alpha$ ,  $\beta$ ,  $\gamma$ ,  $\delta$  must be greater than or equal to 1.1; non-integer values are now allowed.

If  $\alpha$ ,  $\beta$ ,  $\gamma$ ,  $\delta$ , A and B are all set to zero then the following default values are used:

ALPHA	=	2.0
BETA	=	2.0
GAMMA	=	2.0
DELTA	=	4.0
A	=	2.0
B	=	-1.0

FOFFS offsets the yield surface parallel to the axial force axis. It is the compressive axial force at which the maximum bending moment capacity about the local s-axis (determined by LCPMS and SFS), and that about the local t-axis (determined by LCPMT and SFT), occur. For steel beams and columns, the value of FOFFS is usually zero. For reinforce concrete beams, columns and shear walls, the maximum bending moment capacity occurs corresponding to a certain compressive axial force, FOFFS. The value of FOFFS can be input as either positive or negative. Internally, LS-DYNA converts FOFFS to, and regards compressive axial force as, negative.

Interaction surface FTYPE 4 calculates a utilisation parameter using the yield force and moment data given on card 2, but the elements remain elastic even when the forces or moments exceed yield values. This is done for consistency with the design code OBE AISC LRFD (2000). The utilisation calculation is as follows:

$$\text{Utilisation} = K_1 F / (\phi_a F_y) + (K_2 / \phi_b) (M_s / M_{ys} + M_t / M_{yt})$$

where:

$M_s, M_t, F$  are the current moments about local s and t axes and absolute value of axial force respectively

$M_{ys}, M_{yt}, F_y$  are the current yield moments and forces (curve value x scale factor);  $F_y = F_{yt}$  or  $F_{yc}$  (the tensile or compressive yield force) according to whether the member is in tension or compression.

$\phi_a = \phi_t$  or  $\phi_c$  for a member in tension or compression;

$K_1 = 0.5$  if  $F / (\phi_a F_y) < 0.2$ , or 1.0 otherwise

$K_2 = 1.0$  if  $F / (\phi_a F_y) < 0.2$ , or 8/9 otherwise

Interaction surface FTYPE 5 is similar to type 4 (calculates a utilisation parameter using the yield data, but the elements do not yield). The equations are taken from Australian code AS4100. The user must select appropriate values of  $\alpha$ ,  $\beta$ ,  $\gamma$  and  $\delta$  using the various clauses of Section 8 of AS4100. It is assumed that the local s-axis is the major axis for bending.

$$\text{Utilisation} = \max (U_1, U_2, U_3, U_4, U_5)$$

$$U_1 = F / \beta \phi_c F_{yc}$$

Equation 1, used for members in compression

$$U_2 = F / \phi_t F_{yt}$$

Equation 2, used for members in tension

$$U_3 = [M_s / (K_2 \phi_b M_{ys})]^\gamma + [M_t / (K_1 \phi_b M_{yt})]^\gamma$$

Equation 3, used for members in compression

$$U_4 = [M_s / (K_4 \phi_b M_{ys})]^\gamma + [M_t / (K_3 \phi_b M_{yt})]^\gamma$$

Equation 4, used for members in tension

$$U_5 = F / \phi_c F_{yc} + M_s / \phi_b M_{ys} + M_t / \phi_b M_{yt}$$

Equation 5, used for all members

Where:  $M_s, M_t, F, M_{ys}, M_{yt}, F_{yt}, F_{yc}$  are as defined above  
 $K_1 = 1.0 - F/(\beta\phi_c F_{yc})$   
 $K_2 = \text{Min} [K_1, \alpha\{1.0 - F/(\delta\phi_c F_{yc})\}]$   
 $K_3 = 1.0 - F/(\phi_t F_{yt})$   
 $K_4 = \text{Min} [K_3, \alpha\{1.0 + F/(\phi_t F_{yt})\}]$   
( $K_1, K_2, K_3, K_4$  all subject to minimum value of  $10^{-6}$ )  
 $\alpha, \beta, \gamma, \delta, \phi_t, \phi_c, \phi_b$  are input parameters

The option for degrading moment behavior changes the meaning of the plastic moment-rotation curve as follows:

If DEGRAD=0 (not recommended), the x-axis points on the curve represent current plastic rotation (i.e. total rotation minus the elastic component of rotation). This quantity can be positive or negative depending on the direction of rotation; during hysteresis the behavior will repeatedly follow backwards and forwards along the same curve. The curve should include negative and positive rotation and moment values. This option is retained so that results from existing models will be unchanged.

If DEGRAD=1, the x-axis points represent cumulative absolute plastic rotation. This quantity is always positive, and increases whenever there is plastic rotation in either direction. Thus, during hysteresis, the yield moments are taken from points in the input curve with increasingly positive rotation. If the curve shows a degrading behavior (reducing moment with rotation), then, once degraded by plastic rotation, the yield moment can never recover to its initial value. This option can be thought of as having “fatigue-type” hysteretic damage behavior, where all plastic cycles contribute to the total damage.

If DEGRAD=2, the x-axis points represent the high-tide value (always positive) of the plastic rotation. This quantity increases only when the absolute value of plastic rotation exceeds the previously recorded maximum. If smaller cycles follow a larger cycle, the plastic moment during the small cycles will be constant, since the high-tide plastic rotation is not altered by the small cycles. Degrading moment-rotation behavior is possible. This option can be thought of as showing rotation-controlled damage, and follows the FEMA approach for treating fracturing joints.

DEGRAD applies also to the axial behavior. The same options are available as for rotation: DEGRAD=0 gives unchanged behavior from previous versions; DEGRAD=1 gives a fatigue-type behavior using cumulative plastic strain; and DEGRAD=2 gives FEMA-type behavior, where the axial load capacity depends on the high-tide tensile and compressive strains. The definition of strain for this purpose is according to AOPT on Card 1 – it is expected that AOPT=2 will be used with DEGRAD=2. The “axial strain” variable plotted by post-processors is the variable defined by AOPT.

The output variables plotted as “plastic rotation” have special meanings for this material model as follows – note that hinges form only at Node 2:

“Plastic rotation at End 1” is really a high-tide mark of absolute plastic rotation at Node 2, defined as follows:

1. Current plastic rotation is the total rotation minus the elastic component of rotation.
2. Take the absolute value of the current plastic rotation, and record the maximum achieved up to the current time. This is the high-tide mark of plastic rotation.

If DEGRAD=0, “Plastic rotation at End 2” is the current plastic rotation at Node 2.

If DEGRAD=1 or 2, “Plastic rotation at End 2” is the current total rotation at Node 2.

The total rotation is a more intuitively understood parameter, e.g. for plotting hysteresis loops. However, with DEGRAD=0, the previous meaning of that output variable has been retained such that results from existing models are unchanged.

FEMA thresholds are the plastic rotations at which the element is deemed to have passed from one category to the next, e.g. “Elastic”, “Immediate Occupancy”, “Life Safe”, etc. The high-tide plastic rotation (maximum of Y and Z) is checked against the user-defined limits FEMA1, FEMA2, etc. The output flag is then set to 0, 1, 2, 3, or 4: 0 means that the rotation is less than FEMA1; 1 means that the rotation is between FEMA1 and FEMA2, and so on. By contouring this flag, it is possible to see quickly which joints have passed critical thresholds.

For this material model, special output parameters are written to the d3plot and d3thdt files. The number of output parameters for beam elements is automatically increased to 20 (in addition to the six standard resultants) when parts of this material type are present. Some post-processors may interpret this data as if the elements were integrated beams with 4 integration points. Depending on the post-processor used, the data may be accessed as follows:

Extra variable 16 (or Integration point 4 Axial Stress):	FEMA rotation flag
Extra variable 17 (or Integration point 4 XY Shear Stress):	Current utilization
Extra variable 18 (or Integration point 4 ZX Shear Stress):	Maximum utilization to date
Extra variable 20 (or Integration point 4 Axial Strain):	FEMA axial flag

“Utilization” is the yield parameter, where 1.0 is on the yield surface.

\*MAT\_SOIL\_BRICK

Purpose: This is Material Type 192. It is intended for modeling over-consolidated clay.

Card 1            1            2            3            4            5            6            7            8

Variable	MID	RO	RLAMDA	RKAPPA	RIOTA	RBETA1	RBETA2	RMU
Type	A8	F	F	F	F	F	F	F
Default								1.0

Card 2            1            2            3            4            5            6            7            8

Variable	RNU	RLCID	TOL	PGCL	SUB-INC	BLK	GRAV	THEORY
Type	F	F	F	F	F	F	F	I
Default			0.0005				9.807	0

**Define Card 3 only if THEORY>0**

Card 3            1            2            3            4            5            6            7            8

Variable	RVHHH	XSICRIT	ALPHA	RVH	RNU21	ANISO_4		
Type	F	F	F	F	F	F		
Default	0	0	0	0	0	0		

<u>VARIABLE</u>	<u>DESCRIPTION</u>
MID	Material identification. A unique number or label not exceeding 8 characters must be specified.
RO	Mass density
RLAMDA	Material coefficient

<b>VARIABLE</b>	<b>DESCRIPTION</b>
RKAPPA	Material coefficient
RIOTA	Material coefficient
RBETA1	Material coefficient
RBETA2	Material coefficient
RMU	Shape factor coefficient. This parameter will modify the shape of the yield surface used. 1.0 implies a von Mises type surface, but 1.1 to 1.25 is more indicative of soils. The default value is 1.0.
RNU	Poisson's ratio
RLCID	Load curve identification number referring to a curve defining up to 10 pairs of 'string-length' vs G/Gmax points.
TOL	User defined tolerance for convergence checking. Default value is set to 0.02.
PGCL	Pre-consolidation ground level. This parameter defines the maximum surface level (relative to $z = 0.0$ in the model) of the soil throughout geological history. This is used calculate the maximum over burden pressure on the soil elements.
SUB-INC	User defined strain increment size. This is the maximum strain increment that the material model can normally cope with. If the value is exceeded a warning is echoed to the d3hsp file.
BLK	The elastic bulk stiffness of the soil. This is used for the contact stiffness only.
GRAV	The gravitational acceleration. This is used to calculate the element stresses due the overlying soil. Default is set to $9.807 \text{ m/s}^2$ .
THEORY	Version of material subroutines used (See Remarks). EQ. 0: 1995 version, vectorized (Default) EQ. 4: 2003 version, unvectorized
RVHHH	Anisotropy ratio $G_{vh} / G_{hh}$ (default = Isotropic behavior)
XSICRIT	Anisotropy parameter
ALPHA	Anisotropy parameter
RVH	Anisotropy ratio $E_v / E_h$

VARIABLE	DESCRIPTION
RNU21	Anisotropy ratio $\nu_2 / \nu_1$
ANISO_4	Anisotropy parameter

**Remarks:**

- This material type requires that the model is oriented such that the z-axis is defined in the upward direction. Compressive initial stress must be defined, e.g. using \*INITIAL\_STRESS\_SOLID or \*INITIAL\_STRESS\_DEPTH. The recommended unit system is kN, meters, seconds, tonnes. There are some built-in defaults that assume stress units of KN/m<sup>2</sup>.

Over-consolidated clays have suffered previous loading to higher stress levels than are present at the start of the analysis. This could have occurred due to ice sheets during previous ice ages, or the presence of soil or rock that has subsequently been eroded. The maximum vertical stress during that time is assumed to be:

$$\sigma_{VMAX} = RO*GRAV*(PGCL - Z_{el})$$

where

RO, GRAV, PGCL = input parameters  
 $Z_{el}$  = z-coordinate of center of element

Since that time, the material has been unloaded until the vertical stress equals the user-defined initial vertical stress. The previous load/unload history has a significant effect on subsequent behavior, e.g. the horizontal stress in an over-consolidated clay may be greater than the vertical stress.

This material model creates a load/unload cycle for a sample element of each material of this type, stores in a scratch file the horizontal stress and history variables as a function of the vertical stress, and interpolates these quantities from the defined initial vertical stress for each element. Therefore the initial horizontal stress seen in the output files will be different from the input initial horizontal stress.

This material model is developed for a Geotechnical FE program (Oasys Ltd.'s SAFE) written by Arup. The default THEORY=0 gives a vectorized version ported from SAFE in the 1990's. Since then the material model has been developed further in SAFE; the most recent porting is accessed using THEORY=4 (recommended); however, this version is not vectorized and will run more slowly on most computer platforms.

- The shape factor for a typical soil would be 1.25. Do not use values higher than 1.35.

**\*MAT\_DRUCKER\_PRAGER**

Purpose: This is Material Type 193. This material enables soil to be modeled effectively. The parameters used to define the yield surface are familiar geotechnical parameters (i.e. angle of friction). The modified Drucker-Prager yield surface is used in this material model enabling the shape of the surface to be distorted into a more realistic definition for soils.

Card 1            1            2            3            4            5            6            7            8

Variable	MID	RO	GMOD	RNU	RKF	PHI	CVAL	PSI
Type	A8	F	F	F	F	F	F	F
Default					1.0			0.0

Card 2            1            2            3            4            5            6            7            8

Variable	STR_LIM							
Type	F							
Default	0.005							

Card 3            1            2            3            4            5            6            7            8

Variable	GMODDP	PHIDP	CVALDP	PSIDP	GMODGR	PHIGR	CVALGR	PSIGR
Type	F	F	F	F	F	F	F	F
Default	0.0	0.0	0.0	0.0	0.0	0.0	0.0	0.0

<u>VARIABLE</u>	<u>DESCRIPTION</u>
MID	Material identification. A unique number or label not exceeding 8 characters must be specified.
RO	Mass density



<u>VARIABLE</u>	<u>DESCRIPTION</u>
GMOD	Elastic shear modulus
RNU	Poisson's ratio
RKF	Failure surface shape parameter
PHI	Angle of friction (radians)
CVAL	Cohesion value
PSI	Dilation angle (radians)
STR_LIM	Minimum shear strength of material is given by STR_LIM*CVAL
GMODDP	Depth at which shear modulus (GMOD) is correct
PHIDP	Depth at which angle of friction (PHI) is correct
CVALDP	Depth at which cohesion value (CVAL) is correct
PSIDP	Depth at which dilation angle (PSI) is correct
GMODGR	Gradient at which shear modulus (GMOD) increases with depth
PHIGR	Gradient at which friction angle (PHI) increases with depth
CVALGR	Gradient at which cohesion value (CVAL) increases with depth
PSIGR	Gradient at which dilation angle (PSI) increases with depth

**Remarks:**

1. This material type requires that the model is oriented such that the z-axis is defined in the upward direction. The key parameters are defined such that may vary with depth (i.e. the z-axis).
2. The shape factor for a typical soil would be 0.8, but should not be pushed further than 0.75.
3. If STR\_LIM is set to less than 0.005, the value is reset to 0.005.

**\*MAT\_RC\_SHEAR\_WALL**

Purpose: This is Material Type 194. It is for shell elements only. It uses empirically-derived algorithms to model the effect of cyclic shear loading on reinforced concrete walls. It is primarily intended for modeling squat shear walls, but can also be used for slabs. Because the combined effect of concrete and reinforcement is included in the empirical data, crude meshes can be used. The model has been designed such that the minimum amount of input is needed: generally, only the variables on the first card need to be defined.

Card 1            1            2            3            4            5            6            7            8

Variable	MID	RO	E	PR	TMAX			I
Type	A8	F	F	F	F			
Default	none	none	none	0.0	0.0			

**Define the following data if “Uniform Building Code” formula for maximum shear strength or tensile cracking are required – otherwise leave blank.**

Card 2            1            2            3            4            5            6            7            8

Variable	FC	PREF	FYIELD	SIG0	UNCONV	ALPHA	FT	ERIENF
Type	F	F	F	F	F	F	F	F
Default	0.0	0.0	0.0	0.0	0.0	0.0	0.0	0.0

Card 3            1            2            3            4            5            6            7            8

Variable	A	B	C	D	E	F		
Type	F	F	F	F	F	F		
Default	0.05	0.55	0.125	0.66	0.25	1.0		

Card 4            1            2            3            4            5            6            7            8

Variable	Y1	Y2	Y3	Y4	Y5			
Type	F	F	F	F	F			
Default	0.0	0.0	0.0	0.0	0.0			

Card 5            1            2            3            4            5            6            7            8

Variable	T1	T2	T3	T4	T5			
Type	F	F	F	F	F			
Default	0.0	0.0	0.0	0.0	0.0			

Card 6            1            2            3            4            5            6            7            8

Variable	AOPT							
Type	F							
Default	0.0							

Card 7            1            2            3            4            5            6            7            8

Variable	XP	YP	ZP	A1	A2	A3		
Type	F	F	F	F	F	F		
Default	0.0	0.0	0.0	0.0	0.0	0.0		

Card 8            1            2            3            4            5            6            7            8

Variable	V1	V2	V3	D1	D2	D3	BETA	
Type	F	F	F	F	F	F	F	
Default	0.0	0.0	0.0	0.0	0.0	0.0	0.0	

<u>VARIABLE</u>	<u>DESCRIPTION</u>
MID	Material identification. A unique number or label not exceeding 8 characters must be specified.
RO	Mass density
E	Young's Modulus
PR	Poisson's Ratio
TMAX	Ultimate in-plane shear stress. If set to zero, LS-DYNA will calculate TMAX based on the formulae in the Universal Building Code, using the data on card 2. See Remarks.
FC	Unconfined Compressive Strength of concrete (used in the calculation of ultimate shear stress; crushing behavior is not modeled)
PREF	Percent reinforcement, e.g. if 1.2% reinforcement, enter 1.2
FYIELD	Yield stress of reinforcement
SIG0	Overburden stress (in-plane compressive stress) - used in the calculation of ultimate shear stress. Usually sig0 is left as zero.
UCONV	Unit conversion factor. $UCONV = \sqrt{(1.0 \text{ psi in the model stress units})}$ . This is needed because the ultimate tensile stress of concrete is expressed as $\sqrt{(FC)}$ where FC is in psi. Therefore a unit conversion factor of $\sqrt{(\text{psi}/\text{stress unit})}$ is required. Examples: $UCONV = 0.083$ if stress unit is MN/m <sup>2</sup> or N/mm <sup>2</sup> $UCONV = 83.3$ if stress unit is N/m <sup>2</sup>
ALPHA	Shear span factor - see below.
FT	Cracking stress in direct tension - see notes below. Default is 8% of the cylinder strength.

VARIABLE	DESCRIPTION
ERIENF	Young's Modulus of reinforcement. Used in calculation of post-cracked stiffness - see notes below.
A	Hysteresis constants determining the shape of the hysteresis loops.
B	Hysteresis constants determining the shape of the hysteresis loops.
C	Hysteresis constants determining the shape of the hysteresis loops.
D	Hysteresis constants determining the shape of the hysteresis loops.
E	Hysteresis constants determining the shape of the hysteresis loops.
F	Strength degradation factor. After the ultimate shear stress has been achieved, F multiplies the maximum shear stress from the curve for subsequent reloading. F=1.0 implies no strength degradation (default). F=0.5 implies that the strength is halved for subsequent reloading.
Y1,Y2...Y5	Shear strain points on stress-strain curve. By default these are calculated from the values on card 1. See below for more guidance.
T1,T2...T5	Shear stress points on stress-strain curve. By default these are calculated from the values on card 1. See below for more guidance.
AOPT	Material axes option: EQ. 0.0: locally orthotropic with material axes determined by element nodes as shown in Figure 2.1, and then rotated about the shell element normal by the angle BETA. Nodes 1, 2, and 4 of an element are identical to the nodes used for the definition of a coordinate system as by *DEFINE_COORDINATE_NODES. EQ. 2.0: globally orthotropic with material axes determined by vectors defined below, as with *DEFINE_COORDINATE_VECTOR. EQ. 3.0: applicable to shell elements only. This option determines locally orthotropic material axes by offsetting the material axes by an angle to be specified from a line in the plane of the shell determined by taking the cross product of the vector v defined below with the shell normal vector. LT.0.0: the absolute value of AOPT is a coordinate system ID number (CID on *DEFINE_COORDINATE_NODES, *DEFINE_COORDINATE_SYSTEM or *DEFINE_COORDINATE_VECTOR). Available in R3 version of 971 and later.
XP,YP,ZP	Coordinates of point <b>p</b> for AOPT = 1.
A1,A2,A3	Components of vector <b>a</b> for AOPT = 2.

<b>VARIABLE</b>	<b>DESCRIPTION</b>
V1,V2,V3	Components of vector <b>v</b> for AOPT = 3.
D1,D2,D3	Components of vector <b>d</b> for AOPT = 2.
BETA	Material angle in degrees for AOPT = 0 and 3, may be overridden on the element card, see *ELEMENT_SHELL_BETA.

**Remarks:**

The element is linear elastic except for in-plane shear and tensile cracking effects. Crushing due to direct compressive stresses are modeled only insofar as there is an in-plane shear stress component. It is not recommended that this model be used where nonlinear response to direct compressive or loads is important.

Note that the in-plane shear stress is defined as the shear stress in the element’s local x-y plane (txy). This is not necessarily equal to the maximum shear stress in the plane: for example, if the principal stresses are at 45 degrees to the local axes, txy is zero. Therefore it is important to ensure that the local axes are appropriate - for a shear wall the local axes should be vertical or horizontal. By default, local X points from node 1 to node 2 of the element. It is possible to change the local axes by using AOPT>0.

If TMAX is set to zero, the ultimate shear stress is calculated using a formula in the Uniform Building Code 1997, section 1921.6.5:

$$TMAX_{UBC} = UCONV*ALPHA*\sqrt{FC} + Ro*FY$$

where,

- uconv = unit conversion factor, 0.083 for SI units (MN)
- Alpha = aspect ratio, = 2.0 unless ratio h/l < 2.0 in which case alpha varies linearly from 2.0 at h/l=2.0 to 3.0 at h/l=1.5.
- FC = unconfined compressive strength of concrete
- Ro = fraction of reinforcement = percent reinforcement/100
- FY = yield stress of reinforcement

To this we add shear stress due to the overburden to obtain the ultimate shear stress:

$$TMAX_{UBC} = TMAX_{UBC} + SIG0$$

where

SIG0 = in-plane compressive stress under static equilibrium conditions

The UBC formula for ultimate shear stress is generally conservative (predicts that the wall is weaker than shown in test), sometimes by 50% or more. A less conservative formula is that of Fukuzawa:

$$TMAX = a1*2.7*(1.9-M/LV)*UCONV*\sqrt{FC} + Ro*FY*0.5 + SIG0$$

where

a1	=	$\max((0.4 + A_c/A_w), 1.0)$
A <sub>c</sub>	=	Cross-sectional area of stiffening features such as columns or flanges
A <sub>w</sub>	=	Cross-sectional area of wall
M/LV	=	Aspect ratio of wall (height/length)

Other terms are as above. This formula is not included in the material model: TMAX should be calculated by hand and entered on Card 1 if the Fukuzawa formula is required.

It should be noted that none of the available formulae, including Fukuzawa, predict the ultimate shear stress accurately for all situations. Variance from the experimental results can be as great as 50%.

The shear stress vs shear strain curve is then constructed automatically as follows, using the algorithm of Fukuzawa extended by Arup:

Assume ultimate shear strain,  $\gamma_u = 0.0048$

First point on curve (concrete cracking) at  $(0.3TMAX/G, 0.3TMAX)$  where G is the elastic shear modulus given by  $E/2(1+\nu)$

Second point (reinforcement yield) at  $(0.5\gamma_u, 0.8TMAX)$

Third point (ultimate strength) at  $(\gamma_u, TMAX)$

Fourth point (onset of strength reduction) at  $(2\gamma_u, TMAX)$

Fifth point (failure) at  $(3\gamma_u, 0.6TMAX)$ .

After failure, the shear stress drops to zero. The curve points can be entered by the user if desired, in which case they over-ride the automatically calculated curve. However, it is anticipated that in most cases the default curve will be preferred due to ease of input.

Hysteresis follows the algorithm of Shiga as for the squat shear wall spring (see \*MAT\_SPRING\_SQUAT\_SHEARWALL). The hysteresis constants A,B,C,D,E can be entered by the user if desired but it is generally recommended that the default values be used.

Cracking in tension is checked for the local x and y directions only – this is calculated separately from the in-plane shear. A trilinear response is assumed, with turning points at concrete cracking and reinforcement yielding. The three regimes are:

1. Pre-cracking, linear elastic response is assumed using the overall Young's Modulus on Card 1.
2. **Cracking occurs in the local x or y directions when the tensile stress in that direction exceeds the concrete tensile strength FT** (if not input on Card 2, this defaults to 8% of the compressive strength FC). Post-cracking, a linear stress-strain response is assumed up to reinforcement yield at a strain defined by reinforcement yield stress divided by reinforcement Young's Modulus.

3. Post-yield, a constant stress is assumed (no work hardening).

Unloading returns to the origin of the stress-strain curve.

For compressive strains the response is always linear elastic using the overall Young's Modulus on Card 1.

If insufficient data is entered, no cracking occurs in the model. As a minimum, FC and FY are needed.

Extra variables are available for post-processing as follows:

Extra variable 1: Current shear strain

Extra variable 2: Shear status: 0,1,2,3,4 or 5– see below

Extra variable 3: Maximum direct strain so far in local X direction (for tensile cracking)

Extra variable 4: Maximum direct strain so far in local Y direction (for tensile cracking)

Extra variable 5: Tensile status: 0,1 or 2 = elastic, cracked, or yielded respectively.

The shear status shows how far along the shear stress-strain curve each element has progressed, e.g. status 2 means that the element has passed the second point on the curve. These status levels correspond to performance criteria in building design codes such as FEMA.



\*MAT\_CONCRETE\_BEAM

This is Material Type 195 for beam elements. An elasto-plastic material with an arbitrary stress versus strain curve and arbitrary strain rate dependency can be defined. See also Remark below. Also, failure based on a plastic strain or a minimum time step size can be defined.

Card 1            1            2            3            4            5            6            7            8

Variable	MID	RO	E	PR	SIGY	ETAN	FAIL	TDEL
Type	A8	F	F	F	F	F	F	F
Default	none	None	none	none	none	0.0	10.E+20	10.E+20

Card 2            1            2            3            4            5            6            7            8

Variable	C	P	LCSS	LCSR				
Type	F	F	F	F				
Default	0	0	0	0				

Card 3            1            2            3            4            5            6            7            8

Variable	NOTEN	TENCUT	SDR					
Type	I	F	F					
Default	0	E15.0	0.0					

**VARIABLE**

**DESCRIPTION**

- MID            Material identification. A unique number or label not exceeding 8 characters must be specified.
- RO            Mass density.

VARIABLE	DESCRIPTION
E	Young's modulus.
PR	Poisson's ratio.
SIGY	Yield stress.
ETAN	Tangent modulus, ignored if (LCSS.GT.0) is defined.
FAIL	Failure flag. LT.0.0: user defined failure subroutine is called to determine failure EQ.0.0: failure is not considered. This option is recommended if failure is not of interest since many calculations will be saved. GT.0.0: plastic strain to failure. When the plastic strain reaches this value, the element is deleted from the calculation.
TDEL	Minimum time step size for automatic element deletion.
C	Strain rate parameter, C, see formula below.
P	Strain rate parameter, P, see formula below.
LCSS	Load curve ID or Table ID. Load curve ID defining effective stress versus effective plastic strain. If defined EPS1-EPS8 and ES1-ES8 are ignored. The table ID defines for each strain rate value a load curve ID giving the stress versus effective plastic strain for that rate, See Figure 16.1. The stress versus effective plastic strain curve for the lowest value of strain rate is used if the strain rate falls below the minimum value. Likewise, the stress versus effective plastic strain curve for the highest value of strain rate is used if the strain rate exceeds the maximum value. The strain rate parameters: C and P;
LCSR	Load curve ID defining strain rate scaling effect on yield stress.
NOTEN	No-tension flag, EQ.0: beam takes tension, EQ.1: beam takes no tension, EQ.2: beam takes tension up to value given by TENCUT.
TENCUT	Tension cutoff value.
SDR	Stiffness degradation factor.

**Remarks:**

The stress strain behavior may be treated by a bilinear stress strain curve by defining the tangent modulus, ETAN. An effective stress versus effective plastic strain curve (LCSS) may be input

instead of defining ETAN. The cost is roughly the same for either approach. The most general approach is to use the table definition (LCSS) discussed below.

Three options to account for strain rate effects are possible.

- I. Strain rate may be accounted for using the Cowper and Symonds model which scales the yield stress with the factor

$$1 + \left( \frac{\dot{\epsilon}}{C} \right)^{1/p}$$

where  $\dot{\epsilon}$  is the strain rate.  $\dot{\epsilon} = \sqrt{\dot{\epsilon}_{ij} \dot{\epsilon}_{ij}}$ .

- II. For complete generality a load curve (LCSR) to scale the yield stress may be input instead. In this curve the scale factor versus strain rate is defined.
- III. If different stress versus strain curves can be provided for various strain rates, the option using the reference to a table (LCSS) can be used.

**\*MAT\_GENERAL\_SPRING\_DISCRETE\_BEAM**

This is Material Type 196. This model permits elastic and elastoplastic springs with damping to be represented with a discrete beam element type6 by using six springs each acting about one of the six local degrees-of-freedom. For elastic behavior, a load curve defines force or moment versus displacement or rotation. For inelastic behavior, a load curve yield force or moment versus plastic deflection or rotation, which can vary in tension and compression. The two nodes defining a beam may be coincident to give a zero length beam, or offset to give a finite length beam. For finite length discrete beams the absolute value of the variable SCOOR in the SECTION\_BEAM input should be set to a value of 2.0, which causes the local r-axis to be aligned along the two nodes of the beam to give physically correct behavior. The distance between the nodes of a beam should not affect the behavior of this material model. A triad is used to orient the beam for the directional springs.

Card 1            1            2            3            4            5            6            7            8

Variable	MID	RO						
Type	A8	F						

**Define the following cards, 2 and 3, for each active degree of freedom. This data is terminated by the next "\*" card or when all six degrees-of-freedom are defined.**

Card 2            1            2            3            4            5            6            7            8

Variable	DOF	TYPE	K	D	CDF	TDF		
Type	I	I	F	F	F	F		

Card 3            1            2            3            4            5            6            7            8

Variable	FLCID	HLCID	C1	C2	DLE	GLCID		
Type	F	F	F	F	F	I		

<u>VARIABLE</u>	<u>DESCRIPTION</u>
MID	Material identification. A unique number or label not exceeding 8 characters must be specified.

<u>VARIABLE</u>	<u>DESCRIPTION</u>
RO	Mass density, see also volume in *SECTION_BEAM definition.
DOF	Active degree-of-freedom, a number between 1 and 6 inclusive. Each value of DOF can only be used once. The active degree-of-freedom is measured in the local coordinate system for the discrete beam element.
TYPE	The default behavior is elastic. For inelastic behavior input 1.
K	Elastic loading/unloading stiffness. This is required input for inelastic behavior.
D	Optional viscous damping coefficient.
CDF	Compressive displacement at failure. Input as a positive number. After failure, no forces are carried. This option does not apply to zero length springs. EQ.0.0: inactive.
TDF	Tensile displacement at failure. After failure, no forces are carried. EQ.0.0: inactive.
FLCID	Load curve ID, see *DEFINE_CURVE. For option TYPE=0, this curve defines force or moment versus deflection for nonlinear elastic behavior. For option TYPE=1, this curve defines the yield force versus plastic deflection. If the origin of the curve is at (0,0) the force magnitude is identical in tension and compression, i.e., only the sign changes. If not, the yield stress in the compression is used when the spring force is negative. The plastic displacement increases monotonically in this implementation. The load curve is required input.
HLCID	Load curve ID, see *DEFINE_CURVE, defining force versus relative velocity (Optional). If the origin of the curve is at (0,0) the force magnitude is identical for a given magnitude of the relative velocity, i.e., only the sign changes.
C1	Damping coefficient.
C2	Damping coefficient
DLE	Factor to scale time units.
GLCID	Optional load curve ID, see *DEFINE_CURVE, defining a scale factor versus deflection for load curve ID, HLCID. If zero, a scale factor of unity is assumed.

**Remarks:**

If TYPE=0, elastic behavior is obtained. In this case, if the linear spring stiffness is used, the force,  $F$ , is given by:

$$F = F_0 + K\Delta L + D\Delta\dot{L}$$

but if the load curve ID is specified, the force is then given by:

$$F = F_0 + K f(\Delta L) \left[ 1 + C1 \cdot \Delta\dot{L} + C2 \cdot \text{sgn}(\Delta\dot{L}) \ln \left( \max \left\{ 1, \frac{|\Delta\dot{L}|}{DLE} \right\} \right) \right] + D\Delta\dot{L} + g(\Delta L)h(\Delta\dot{L})$$

In these equations,  $\Delta L$  is the change in length

$$\Delta L = \text{current length} - \text{initial length}$$

If TYPE=1, inelastic behavior is obtained. In this case, the yield force is taken from the load curve:

$$F^Y = F_y(\Delta L^{\text{plastic}})$$

where  $L^{\text{plastic}}$  is the plastic deflection. A trial force is computed as:

$$F^T = F^n + K\Delta\dot{L}(\Delta t)$$

and is checked against the yield force to determine  $F$ :

$$F = \begin{cases} F^Y & \text{if } F^T > F^Y \\ F^T & \text{if } F^T \leq F^Y \end{cases}$$

The final force, which includes rate effects and damping, is given by:

$$F^{n+1} = F \cdot \left[ 1 + C1 \cdot \Delta\dot{L} + C2 \cdot \text{sgn}(\Delta\dot{L}) \ln \left( \max \left\{ 1, \frac{|\Delta\dot{L}|}{DLE} \right\} \right) \right] + D\Delta\dot{L} + g(\Delta L)h(\Delta\dot{L})$$

Unless the origin of the curve starts at (0,0), the negative part of the curve is used when the spring force is negative where the negative of the plastic displacement is used to interpolate,  $F_y$ . The positive part of the curve is used whenever the force is positive.

The cross sectional area is defined on the section card for the discrete beam elements, See \*SECTION\_BEAM. The square root of this area is used as the contact thickness offset if these elements are included in the contact treatment.

\*MAT\_SEISMIC\_ISOLATOR

This is Material Type 197 for discrete beam elements. Sliding (pendulum) and elastomeric seismic isolation bearings can be modeled, applying bi-directional coupled plasticity theory. The hysteretic behavior was proposed by Wen [1976] and Park, Wen, and Ang [1986]. The sliding bearing behavior is recommended by Zayas, Low and Mahin [1990]. The algorithm used for implementation was presented by Nagarajaiah, Reinhorn, and Constantinou [1991]. Further options for tension-carrying friction bearings are as recommended by Roussis and Constantinou [2006]. Element formulation type 6 must be used. Local axes are defined on \*SECTION\_BEAM; the default is the global axis system. It is expected that the local z-axis will be vertical.

(Note: Option **ITYPE=2** is available starting with the R3 release of Version 971.)

Card 1            1            2            3            4            5            6            7            8

Variable	MID	RO	A	GAMMA	BETA	DISPY	STIFFV	ITYPE
Type	A8	F	F	F	F	F	F	I
Default	none	None	1.0	0.5	0.5	0.0	0.0	0.0

Card 2            1            2            3            4            5            6            7            8

Variable	PRELOAD	DAMP	MX1	MX2	MY1	MY2		
Type	F	F	F	F	F	F		
Default	0	1.0	0	0	0	0		

**Card 3 for sliding isolator, ITYPE = 0 or 2 - leave blank for elastomeric isolator:**

Card 3            1            2            3            4            5            6            7            8

Variable	FMAX	DELF	AFRIC	RADX	RADY	RADB	STIFFL	STIFFTS
Type	F	F	F	F	F	F	F	F
Default	0	0	0	1.0e20	1.0e20	1.0e20	STIFFV	0

**Card 4 for ITYPE = 1 or 2 - leave blank for sliding isolator ITYPE = 0:**

Card 4            1            2            3            4            5            6            7            8

Variable	FORCEY	ALPHA	STIFFT	DFAIL	FMAXYC	FMAXXT	FMAXYT	YLOCK
Type	F	F	F	F	F	F	F	F
Default	0	0	0.5STIFFV	1.0e20	FMAX	FMAX	FMAX	0.0

<u>VARIABLE</u>	<u>DESCRIPTION</u>
MID	Material identification. A unique number or label not exceeding 8 characters must be specified.
RO	Mass density.
A	Nondimensional variable - see below
GAMMA	Nondimensional variable - see below
BETA	Nondimensional variable - see below
DISPY	Yield displacement (length units - must be > 0.0)
STIFFV	Vertical stiffness (force/length units)
ITYPE	Type: 0=sliding (spherical or cylindrical) 1=elastomeric 2=sliding (two perpendicular curved beams)
PRELOAD	Vertical preload not explicitly modeled (force units)



<u>VARIABLE</u>	<u>DESCRIPTION</u>
DAMP	Damping ratio (nondimensional)
MX1, MX2	Moment factor at ends 1 and 2 in local X-direction
MY1, MY2	Moment factor at ends 1 and 2 in local Y-direction
FMAX (*)	Maximum friction coefficient (dynamic)
DELF (*)	Difference between maximum friction and static friction coefficient
AFRIC (*)	Velocity multiplier in sliding friction equation (time/length units)
RADX (*)	Radius for sliding in local X direction
RADY (*)	Radius for sliding in local Y direction
RADB (*)	Radius of retaining ring
STIFFL (*)	Stiffness for lateral contact against the retaining ring
STIFFTS (*)	Stiffness for tensile vertical response (sliding isolator - default = 0)
FORCEY (+)	Yield force
ALPHA (+)	Ratio of postyielding stiffness to preyielding stiffness
STIFFT (+)	Stiffness for tensile vertical response (elastomeric isolator)
DFAIL (+)	Lateral displacement at which the isolator fails
FMAXYC (**)	Max friction coefficient (dynamic) for local Y-axis (compression)
FMAXXT (**)	Max friction coefficient (dynamic) for local X-axis (tension)
FMAXYT (**)	Max friction coefficient (dynamic) for local Y-axis (tension)
YLOCK (**)	Stiffness locking the local Y-displacement (optional -single-axis sliding)

(\*) - Used for sliding type. Leave blank for elastomeric type

(+) - Used for elastomeric type. Leave blank for sliding type

(\*\*) - Used for ITYPE=2. Leave blank for ITYPE=0 or 1

**Remarks:**

The horizontal behavior of both types is governed by plastic history variables  $Z_x$ ,  $Z_y$  that evolve according to equations given in the reference;  $A$ ,  $\gamma$  and  $\beta$  and the yield displacement are the input parameters for this. The intention is to provide smooth build-up, rotation and reversal of forces in response to bidirectional displacement histories in the horizontal plane. The theoretical model has been correlated to experiments on seismic isolators.

The RADX, RADY inputs for the sliding isolator are optional. If left blank, the sliding surface is assumed to be flat. A cylindrical surface is obtained by defining either RADX or RADY; a spherical surface can be defined by setting RADX=RADY. The effect of the curved surface is to add a restoring force proportional to the horizontal displacement from the center. As seen in elevation, the top of the isolator will follow a curved trajectory, lifting as it displaces away from the center.

The vertical behavior for all types is linear elastic, but with different stiffnesses for tension and compression. By default, the tensile stiffness is zero for the sliding types.

The vertical behavior for the elastomeric type is linear elastic; in the case of uplift, the tensile stiffness will be different to the compressive stiffness. For the sliding type, compression is treated as linear elastic but no tension can be carried.

Vertical preload can be modeled either explicitly (for example, by defining gravity), or by using the PRELOAD input. PRELOAD does not lead to any application of vertical force to the model. It is added to the compression in the element before calculating the friction force and tensile/compressive vertical behavior.

ITYPE=0 is used to model a single (spherical) pendulum bearing. Triple pendulum bearings can be modelled using three of these elements in series, following the method described by Fenz and Constantinou 2008. The input properties for the three elements (given by  $\bar{R}_{eff1}$ ,  $\bar{\mu}_1$ ,  $\bar{d}_1$ ,  $\bar{a}_1$ , etc) are calculated from the properties of the actual triple bearing (given by  $R_{eff1}$ ,  $\mu_1$ ,  $d_1$ ,  $a_1$ , etc) as follows:

ITYPE=2 is intended to model uplift-prevention sliding isolators that consist of two perpendicular curved beams joined by a connector that can slide in slots on both beams. The beams are aligned in the local X and Y axes respectively. The vertical displacement is the sum of the displacements induced by the respective curvatures and slider displacements along the two beams. Single-axis sliding is obtained by using YLOCK to lock the local-Y displacement. To resist uplift, STIFFTS must be defined (recommended value: same as STIFFV). This isolator type allows different friction coefficients on each beam, and different values in tension and compression. The total friction, taking into account sliding velocity and the friction history functions, is first calculated using FMAX and then scaled by FMAXXT/FMAX etc as appropriate. For this reason, FMAX should not be zero.

DAMP is the fraction of critical damping for free vertical vibration of the isolator, based on the mass of the isolator (including any attached lumped masses) and its vertical stiffness. The viscosity is reduced automatically if it would otherwise infringe numerical stability. Damping is generally recommended: oscillations in the vertical force would have a direct effect on friction forces in sliding isolators; for isolators with curved surfaces, vertical oscillations can be excited

as the isolator slides up and down the curved surface. It may occasionally be necessary to increase DAMP if these oscillations become significant.

This element has no rotational stiffness - a pin joint is assumed. However, if required, moments can be generated according to the vertical load times the lateral displacement of the isolator. The moment about the local X-axis (i.e. the moment that is dependent on lateral displacement in the local Y-direction) is reacted on nodes 1 and 2 of the element in the proportions MX1 and MX2 respectively. Similarly, moments about the local Y-axis are reacted in the proportions MY1, MY2. These inputs effectively determine the location of the pin joint: for example, a pin at the base of the column could be modeled by setting MX1=MY1=1.0, MX2=MY2=0.0 and ensuring that node 1 is on the foundation, node 2 at the base of the column - then all the moment is transferred to the foundation. For the same model, MX1=MY1=0.0, MX2=MY2=1.0 would imply a pin at the top of the foundation - all the moment is transferred to the column. Some isolator designs have the pin at the bottom for moments about one horizontal axis, and at the top for the other axis - these can be modeled by setting MX1=MY2=1.0, MX2=MY1=0.0. It is expected that all MX1,2, etc lie between 0 and 1, and that MX1+MX2=1.0 (or both can be zero) - e.g. MX1=MX2=0.5 is permitted - but no error checks are performed to ensure this; similarly for MY1+MY2.

Density should be set to a reasonable value, say 2000 to 8000 kg/m<sup>3</sup>. The element mass will be calculated as density x volume (volume is entered on \*SECTION\_BEAM).

Note on values for \*SECTION\_BEAM:

- Set ELFORM to 6 (discrete beam)
- VOL (the element volume) might typically be set to 0.1m<sup>3</sup>
- INER needs to be non-zero (say 1.0) but the value has no effect on the solution since the element has no rotational stiffness.
- CID can be left blank if the isolator is aligned in the global coordinate system, otherwise a coordinate system should be referenced.
- By default, the isolator will be assumed to rotate with the average rotation of its two nodes. If the base of the column rotates slightly the isolator will no longer be perfectly horizontal: this can cause unexpected vertical displacements coupled with the horizontal motion. To avoid this, rotation of the local axes of the isolator can be eliminated by setting RRCON, SRCON and TRCON to 1.0. This does not introduce any rotational restraint to the model, it only prevents the orientation of the isolator from changing as the model deforms.
- All other parameters on \*SECTION\_BEAM can be left blank.

Post-processing note: as with other discrete beam material models, the force described in post-processors as “Axial” is really the force in the local X-direction; “Y-Shear” is really the force in the local Y-direction; and “Z-Shear” is really the force in the local Z-direction.

**\*MAT\_JOINTED\_ROCK**

This is Material Type 198. Joints (planes of weakness) are assumed to exist throughout the material at a spacing small enough to be considered ubiquitous. The planes are assumed to lie at constant orientations defined on this material card. Up to three planes can be defined for each material. The matrix behavior is modified Drucker Prager, as per material type 193.

Card 1            1            2            3            4            5            6            7            8

Variable	MID	RO	GMOD	RNU	RKF	PHI	CVAL	PSI
Type	A8	F	F	F	F	F	F	F
Default					1.0			0.0

Card 2            1            2            3            4            5            6            7            8

Variable	STR_LIM	NPLANES	ELASTIC	LCCPDR	LCCPT	LCCJDR	LCCJT	LCSFAC
Type	F	I	I	I	I	I	I	I
Default	0.005	0	0	0	0	0	0	0

Card 3            1            2            3            4            5            6            7            8

Variable	GMODDP	PHIDP	CVALDP	PSIDP	GMODGR	PHIGR	CVALGR	PSIGR
Type	F	F	F	F	F	F	F	F
Default	0.0	0.0	0.0	0.0	0.0	0.0	0.0	0.0

Repeat Card 4 for each plane (maximum 3 planes):

Card 4            1            2            3            4            5            6            7            8

Variable	DIP	STRIKE	CPLANE	FRPLANE	TPLANE	SHRMAX	LOCAL	
Type	F	F	F	F	F	F	F	
Default	0.0	0.0	0.0	0.0	0.0	1.e20	0.0	

<u>VARIABLE</u>	<u>DESCRIPTION</u>
MID	Material identification. A unique number or label not exceeding 8 characters must be specified.
RO	Mass density
GMOD	Elastic shear modulus
RNU	Poisson's ratio
RKF	Failure surface shape parameter
PHI	Angle of friction (radians)
CVAL	Cohesion value
PSI	Dilation angle (radians)
STR_LIM	Minimum shear strength of material is given by STR_LIM*CVAL
NPLANES	Number of joint planes (maximum 3)
ELASTIC	Flag = 1 for elastic behavior only
LCCPDR	Load curve for extra cohesion for parent material (dynamic relaxation)
LCCPT	Load curve for extra cohesion for parent material (transient)
LCCJDR	Load curve for extra cohesion for joints (dynamic relaxation)
LCCJT	Load curve for extra cohesion for joints (transient)
LCSFAC	Load curve giving factor on strength vs time
GMODDP	Depth at which shear modulus (GMOD) is correct

<u>VARIABLE</u>	<u>DESCRIPTION</u>
PHIDP	Depth at which angle of friction (PHI) is correct
CVALDP	Depth at which cohesion value (CVAL) is correct
PSIDP	Depth at which dilation angle (PSI) is correct
GMODGR	Gradient at which shear modulus (GMOD) increases with depth
PHIGR	Gradient at which friction angle (PHI) increases with depth
CVALGR	Gradient at which cohesion value (CVAL) increases with depth
PSIGR	Gradient at which dilation angle (PSI) increases with depth
DIP	Angle of the plane in degrees below the horizontal
DIPANG	Plan view angle (degrees) of downhill vector drawn on the plane
CPLANE	Cohesion for shear behavior on plane
PHPLANE	Friction angle for shear behavior on plane (degrees)
TPLANE	Tensile strength across plane (generally zero or very small)
SHRMAX	Max shear stress on plane (upper limit, independent of compression)
LOCAL	EQ.0: DIP and DIPANG are with respect to the global axes

**Remarks:**

1. The joint plane orientations are defined by the angle of a “downhill vector” drawn on the plane, i.e. the vector is oriented within the plane to obtain the maximum possible downhill angle. DIP is the angle of this line below the horizontal. DIPANG is the plan-view angle of the line (pointing down hill) measured clockwise from the global Y-axis about the global Z-axis.
2. The joint planes rotate with the rigid body motion of the elements, irrespective of whether their initial definitions are in the global or local axis system.
3. The full facilities of the modified Drucker Prager model for the matrix material can be used – see description of Material type 193. Alternatively, to speed up the calculation, the ELASTIC flag can be set to 1, in which case the yield surface will not be considered and only RO, GMOD, RNU, GMODDP, GMODGR and the joint planes will be used.
4. This material type requires that the model is oriented such that the z-axis is defined in the upward direction. The key parameters are defined such that may vary with depth (i.e. the z-axis)

5. The shape factor for a typical soil would be 0.8, but should not be pushed further than 0.75.
6. If STR\_LIM is set to less than 0.005, the value is reset to 0.005.
7. A correction has been introduced into the Drucker Prager model, such that the yield surface never infringes the Mohr-Coulomb criterion. This means that the model does not give the same results as a “pure” Drucker Prager model.
8. The load curves LCCPDR, LCCPT, LCCJDR, LCCJT allow additional cohesion to be specified as a function of time. The cohesion is additional to that specified in the material parameters. This is intended for use during the initial stages of an analysis to allow application of gravity or other loads without cracking or yielding, and for the cracking or yielding then to be introduced in a controlled manner. This is done by specifying extra cohesion that exceeds the expected stresses initially, then declining to zero. If no curves are specified, no extra cohesion is applied.
9. The load curve for factor on strength applies simultaneously to the cohesion and tan (friction angle) of parent material and all joints. This feature is intended for reducing the strength of the material gradually, to explore factors of safety. If no curve is present, a constant factor of 1 is assumed. Values much greater than 1.0 may cause problems with stability.
10. Extra variables for plotting. By setting NEIPH on \*DATABASE\_EXTENT\_BINARY to 15, the following variables can be plotted in D3PLOT and T/HIS:
  - Extra Variable 1: Mobilized strength fraction for base material
  - Extra Variable 2: rk0 for base material
  - Extra Variable 3: rlamda for base material
  - Extra Variable 4: crack opening strain for plane 1
  - Extra Variable 5: crack opening strain for plane 2
  - Extra Variable 6: crack opening strain for plane 3
  - Extra Variable 7: crack accumulated shear strain for plane 1
  - Extra Variable 8: crack accumulated shear strain for plane 2
  - Extra Variable 9: crack accumulated shear strain for plane 3
  - Extra Variable 10: current shear utilization for plane 1
  - Extra Variable 11: current shear utilization for plane 2
  - Extra Variable 12: current shear utilization for plane 3
  - Extra Variable 13: maximum shear utilization to date for plane 1
  - Extra Variable 14: maximum shear utilization to date for plane 2
  - Extra Variable 15: maximum shear utilization to date for plane 3
14. Joint planes would generally be defined in the global axis system if they are taken from survey data. However, the material model can also be used to represent masonry, in which case the weak planes represent the cement and lie parallel to the local element axes.

**\*MAT\_STEEL\_EC3**

This is Material Type 202. Tables and formulae from Eurocode 3 are used to derive the mechanical properties and their variation with temperature, although these can be overridden by user-defined curves. It is currently available only for Hughes-Liu beam elements. Warning, this material is still under development and should be used with caution.

Card 1            1            2            3            4            5            6            7            8

Variable	MID	RO	E	PR	SIGY			
Type	A8	F	F	F	F			
Default	none	none	none	none	none			

Card 2            1            2            3            4            5            6            7            8

Variable	LC_E	LC_PR	LC_AL	TBL_SS	LC_FS			
Type	F	F	F	F	F			
Default	none	none	none	none	none			

**Card 3 must be define but is left blank**

Card 3            1            2            3            4            5            6            7            8

Variable	(blank)							
Type								
Default								

<u>VARIABLE</u>	<u>DESCRIPTION</u>
MID	Material identification. A unique number or label not exceeding 8 characters must be specified.



<u>VARIABLE</u>	<u>DESCRIPTION</u>
RO	Mass density.
E	Young's modulus – a reasonable value must be provided even if LC_E is also input. See notes.
PR	Poisson's ratio.
SIGY	Initial yield stress, $\sigma_{y0}$ .
LC_E	Optional Loadcurve ID: Young's Modulus vs Temperature (overrides E and factors from EC3).
LC_PR	Optional Loadcurve ID: Poisson's Ratio vs Temperature (overrides PR).
LC_AL	Optional Loadcurve ID: alpha vs temperature (over-rides thermal expansion data from EC3).
TBL_SS	Optional Table ID containing stress-strain curves at different temperatures (overrides curves from EC3).
LC_FS	Optional Loadcurve ID: failure strain vs temperature.

**Remarks:**

1. This material model is intended for modelling structural steel in fires.
2. By default, only E, PR and SIGY have to be defined. Eurocode 3 (EC3) Section 3.2 specifies the stress-strain behaviour of carbon steels at temperatures between 20C and 1200C. The stress-strain curves given in EC3 are scaled within the material model such that the maximum stress at low temperatures is SIGY, see graph below.
3. By default, the Young's Modulus E will be scaled by a factor which is a function of temperature as specified in EC3. The factor is 1.0 at low temperature.
4. By default, the thermal expansion coefficient as a function of temperature will be as specified in EC3 Section 3.4.1.1.
5. LC\_E, LC\_PR and LC\_AL are optional; they should have temperature on the x-axis and the material property on the y-axis, with the points in order of increasing temperature. If present (i.e. non-zero) they over-ride E, PR, and the relationships from EC3. However, a reasonable value for E should always be included, since these values will be used for purposes such as contact stiffness calculation.
6. TBL\_SS is optional. If present, TBL\_SS must be the ID of a \*DEFINE\_TABLE. TBL\_SS overrides SIGY and the stress-strain relationships from EC3. The field VALUE on the \*DEFINE\_TABLE should contain the temperature at which each stress-strain curve is applicable; the temperatures should be in ascending order. The curves that follow the temperature values have (true) plastic strain on the x-axis, (true) yield stress on the y-axis as

per other LS-DYNA elasto-plastic material models. As with all instances of \*DEFINE TABLE, the curves containing the stress-strain data must immediately follow the \*DEFINE\_TABLE input data and must be in the correct order (i.e. the same order as the temperatures).

- 7. Temperature can be defined by any of the \*LOAD\_THERMAL methods. The temperature does not have to start at zero: the initial temperature will be taken as a reference temperature for each element, so non-zero initial temperatures will not cause thermal shock effects.

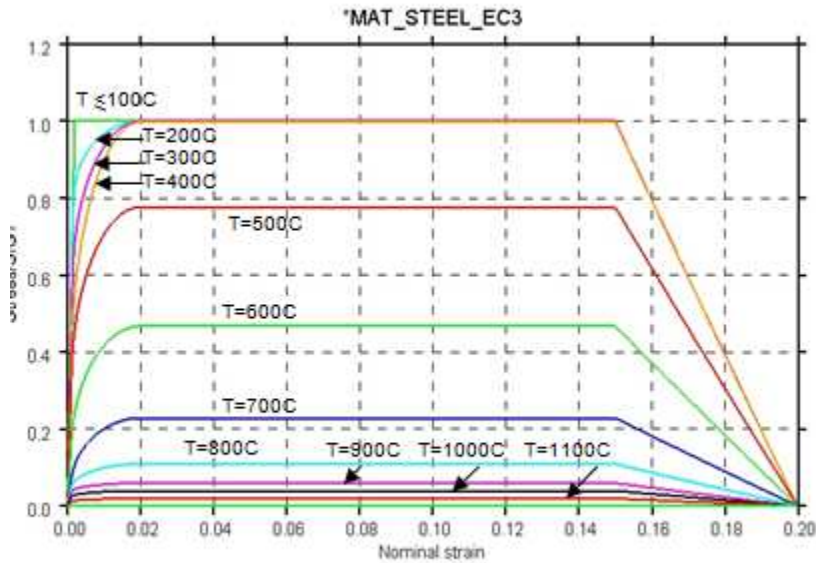

\*MAT\_BOLT\_BEAM

This is Material Type 208 for use with beam elements using ELFORM=6 (Discrete Beam). The beam elements must have nonzero initial length so that the directions in which tension and compression act can be distinguished. See notes below.

Card 1            1            2            3            4            5            6            7            8

Variable	MID	RO	KAX	KSHR	blank	blank	FPRE	TRAMP
Type	A8	F	F	F			F	F
Default	none	none	0.0	0.0			0.0	0.0

Card 2            1            2            3            4            5            6            7            8

Variable	LCAX	LCSHR	FRIC	CLEAR	DAFAIL	DRFAIL	DAMAG	TOPRE
Type	I	I	F	F	F	F	F	F
Default	0	0	0.0	0.0	1.E20	1.E20	0.1	0.0

Card 3 is blank but must be present

Card 3            1            2            3            4            5            6            7            8

Variable	blank							
Type								
Default								

<u>VARIABLE</u>	<u>DESCRIPTION</u>
MID	Material identification. A unique number or label not exceeding 8 characters must be specified.
RO	Mass density.

<u>VARIABLE</u>	<u>DESCRIPTION</u>
G	Shear modulus.
KAX	Axial elastic stiffness (Force/Length units).
KSHR	Shear elastic stiffness (Force/Length units).
FPRE	Preload force.
TRAMP	Time duration during which preload is ramped up.
LCAX	Load curve giving axial load versus displacement (x-axis = displacement (length units), y-axis = force).
LCSHR	Load curve ID or table ID giving lateral load versus displacement (x-axis - displacement (length units), y-axis - force). In the table case, each curve in the table represents lateral load versus displacement at a given (current) axial load, i.e. the values in the table are axial forces.
FRIC	Friction coefficient resisting sliding of bolt head/nut (non-dimensional).
CLEAR	Radial clearance (gap between bolt shank and the inner diameter of the hole) (length units).
DAFAIL	Axial tensile displacement to failure (length units).
DRFAIL	Radial displacement to failure (excludes clearance).
DAMAG	Fraction of above displacements between initiation & completion of failure.
TOPRE	Time at which preload application begins.

**Remarks:**

The element represents a bolted joint. The axial response is tensile-only. Instead of generating a compressive axial load, it is assumed that a gap would develop between the bolt head (or nut) and the surface of the plate. Contact between the bolted surfaces must be modelled separately, e.g. using \*CONTACT or \*MAT\_DISCRETE\_BEAM\_SURFACE\_CONTACT.

Curves LCAX, LCSHR give yield force versus plastic displacement for the axial and shear directions. The force increments are calculated from the elastic stiffnesses, subject to the yield force limits given by the curves.

CLEAR allows the bolt to slide in shear, resisted by friction between bolt head/nut and the surfaces of the plates, from the initial position at the centre of the hole. CLEAR is the total sliding shear displacement before contact occurs between the bolt shank and the inside surface of

the hole. Sliding shear displacement is not included in the displacement used for LCSHR; LCSHR is intended to represent the behaviour after the bolt shank contacts the edge of the hole.

Output: beam “axial” or “X” force is the axial force in the beam. “shear-Y” and “shear-Z” are the shear forces.

Other output is written to the d3plot and d3thdt files in the places where post-processors expect to find the stress and strain at the first two integration points for integrated beams.

Post-Processing data component	Actual meaning
Int. Pt 1, Axial Stress	Change of length
Int Pt 1, XY Shear stress	Sliding shear displacement in local Y
Int Pt 1, ZX Shear stress	Sliding shear displacement in local Z
Int Pt 1, Plastic strain	Resultant shear sliding displacement
Int Pt 1, Axial strain	Axial plastic displacement
Int. Pt 2, Axial Stress	Shear plastic displacement excluding sliding
Int Pt 2, XY Shear stress	-
Int Pt 2, ZX Shear stress	-
Int Pt 2, Plastic strain	-
Int Pt 2, Axial strain	-

**\*MAT\_CODAM2**

This is material type 219. This material model is the second generation of the UBC Composite Damage Model (CODAM2) for brick, shell, and thick shell elements developed at The University of British Columbia. The model is a sub-laminate-based continuum damage mechanics model for fiber reinforced composite laminates made up of transversely isotropic layers. The material model includes an optional non-local averaging and element erosion.

Card 1            1            2            3            4            5            6            7            8

Variable	MID	RO	EA	EB		PRBA		PRCB
Type	A8	F	F	F		F		F
Default	none	none	none	none		none		none

Card 2            1            2            3            4            5            6            7            8

Variable	GAB			NLAYER	R1	R2	NFREQ	
Type	F			I	F	F	I	
Default	none			0	0.0	0.0	0	

Card 3            1            2            3            4            5            6            7            8

Variable	XP	YP	ZP	A1	A2	A3	AOPT	
Type	F	F	F	F	F	F	I	
Default	0.0	0.0	0.0	0.0	0.0	0.0	0	

Card 4            1            2            3            4            5            6            7            8

Variable	V1	V2	V3	D1	D2	D3	BETA	MACF
Type	F	F	F	F	F	F	F	I
Default	0.0	0.0	0.0	0.0	0.0	0.0	0.0	0

**Input NLAYER angles.**

Card 5            1            2            3            4            5            6            7            8

Variable	ANGLE1	ANGLE2	ANGLE3	ANGLE4	ANGLE5	ANGLE6	ANGLE7	ANGLE8
Type	F	F	F	F	F	F	F	F
Default	none	none	none	none	none	none	none	none

Card 6            1            2            3            4            5            6            7            8

Variable	IMATT	IFIBT	ILOCT	IDELT	SMATT	SFIBT	SLOCT	SDELT
Type	F	F	F	F	F	F	F	F
Default	none	none	none	none	none	none	none	none

Card 7            1            2            3            4            5            6            7            8

Variable	IMATC	IFIBC	ILOCC	IDELC	SMATC	SFIBC	SLOCC	SDELC
Type	F	F	F	F	F	F	F	F
Default	none	none	none	none	none	none	none	none

Card 8            1            2            3            4            5            6            7            8

Variable	ERODE	ERPAR1	ERPAR2	RESIDS				
Type	I	F	F	F				
Default	0	none	none	0				

<u>VARIABLE</u>	<u>DESCRIPTION</u>
MID	Material identification. A unique number or label not exceeding 8 characters must be specified.
RO	Mass density
EA	$E_a$ , Young's modulus in a-direction = Modulus along the direction of fibers.
EB	$E_b$ , Young's modulus in b-direction = Modulus transverse to fibers.
PRBA	$\nu_{ba}$ , Poisson's ratio, ba (minor in-plane Poisson's ratio).
PRCB	$\nu_{cb}$ , Poisson's ratio, cb (Poisson's ratio in the plane of isotropy).
GAB	$G_{ab}$ , Shear modulus, ab (in-plane shear modulus).
NLAYER	Number of layers in the sub-laminate excluding symmetry. As an example, in a $[0/45/-45/90]_{3s}$ , NLAYER=4.
R1	Non-local averaging radius.
R2	Currently not used.
NFREQ	Number of time steps between update of neighbor list for nonlocal smoothing. EQ.0:        Do only one search at the start of the calculation
XP,YP,ZP	Coordinates of point <b>p</b> for AOPT = 1.
A1,A2,A3	Components of vector <b>a</b> for AOPT = 2.



VARIABLE	DESCRIPTION
AOPT	<p>Material axes option (see <i>MAT_OPTION TROPIC_ELASTIC</i> for a more complete description):</p> <p>EQ. 0.0: locally orthotropic with material axes determined by element nodes 1, 2, and 4, as with <i>*DEFINE_COORDINATE_NODES</i>.</p> <p>EQ. 1.0: locally orthotropic with material axes determined by a point in space and the global location of the element center; this is the a-direction. This option is for solid elements only.</p> <p>EQ. 2.0: globally orthotropic with material axes determined by vectors defined below, as with <i>*DEFINE_COORDINATE_VECTOR</i>.</p> <p>EQ. 3.0: locally orthotropic material axes determined by rotating the material axes about the element normal by an angle, BETA, from a line in the plane of the element defined by the cross product of the vector <math>\mathbf{v}</math> with the element normal.</p> <p>EQ. 4.0: locally orthotropic in cylindrical coordinate system with the material axes determined by a vector <math>\mathbf{v}</math>, and an originating point, P, which define the centerline axis. This option is for solid elements only.</p> <p>LT.0.0: the absolute value of AOPT is a coordinate system ID number (CID on <i>*DEFINE_COORDINATE_NODES</i>, <i>*DEFINE_COORDINATE_SYSTEM</i> or <i>*DEFINE_COORDINATE_VECTOR</i>).</p>
V1,V2,V3	Components of vector $\mathbf{v}$ for AOPT = 3.
D1,D2,D3	Components of vector $\mathbf{d}$ for AOPT = 2.
BETA	Material angle in degrees for AOPT = 3, may be overridden on the element card, see <i>*ELEMENT_SHELL_BETA</i> or <i>*ELEMENT_SOLID_ORTHO</i> .
MACF	<p>Material axes change flag for brick elements:</p> <p>EQ.1: No change, default,</p> <p>EQ.2: switch material axes a and b,</p> <p>EQ.3: switch material axes a and c,</p> <p>EQ.4: switch material axes b and c.</p>
ANGLEi	Rotation angle in degrees of layers with respect to the material axes. Input one for each layer.
IMATT	Initiation strain for damage in matrix (transverse) under tensile condition.
IFIBT	Initiation strain for damage in the fiber (longitudinal) under tensile condition.

<b>VARIABLE</b>	<b>DESCRIPTION</b>
ILOCT	Initiation strain for the anti-locking mechanism. This parameter should be equal to the saturation strain for the fiber damage mechanism under tensile condition.
IDELT	Not working in the current version. Can be used for visualization purpose only.
SMATT	Saturation strain for damage in matrix (transverse) under tensile condition.
SFIBT	Saturation strain for damage in the fiber (longitudinal) under tensile condition.
SLOCT	Saturation strain for the anti-locking mechanism under tensile condition. The recommended value for this parameter is (ILOCT+0.02).
SDELT	Not working in the current version. Can be used for visualization purpose only.
IMATC	Initiation strain for damage in matrix (transverse) under compressive condition.
IFIBC	Initiation strain for damage in the fiber (longitudinal) under compressive condition.
ILOCC	Initiation strain for the anti-locking mechanism. This parameter should be equal to the saturation strain for the fiber damage mechanism under compressive condition.
IDELC	Initiation strain for delamination. Not working in the current version. Can be used for visualization purpose only.
SMATC	Saturation strain for damage in matrix (transverse) under compressive condition.
SFIBC	Saturation strain for damage in the fiber (longitudinal) under compressive condition.
SLOCC	Saturation strain for the anti-locking mechanism under compressive condition. The recommended value for this parameter is (ILOCC+0.02).
SDELC	Delamination strain. Not working in the current version. Can be used for visualization purpose only.

VARIABLE	DESCRIPTION
ERODE	Erosion Flag (see remarks) EQ. 0: Erosion is turned off. EQ. 1: Non-local strain based erosion criterion. EQ. 2: Local strain based erosion criterion. EQ.3: Use both ERODE=1 and ERODE=2 criteria.
ERPAR1	The erosion parameter #1 used in ERODE types 1 and 3. ERPAR1 >= 1.0 and the recommended value is ERPAR1=1.2.
ERPAR2	The erosion parameter #2 used in ERODE types 2 and 3. The recommended value is five times SLOC defined in cards 7 and 8.
RESIDS	Residual strength for layer damage

### Remarks:

### Model Description

CODAM2 is developed for modeling the nonlinear, progressive damage behavior of laminated fiber-reinforced plastic materials. The model is based on the work by (Forghani, 2011; Forghani et al. 2011a; Forghani et al. 2011b) and is an extension of the original model, CODAM (Williams et al. 2003).

Briefly, the model uses a continuum damage mechanics approach and the following assumptions have been made in its development:

1. The material is an orthotropic medium consisting of a number of repeating units through the thickness of the laminate, called sub-laminates. e.g. . [0/±45/90] in a [0/±45/90]<sub>SS</sub> laminate.
2. The nonlinear behavior of the composite sub-laminate is only caused by damage evolution. Nonlinear elastic or plastic deformations are not considered.

### Formulation

The in-plane secant stiffness of the damaged laminate is represented as the summation of the effective contributions of the layers in the laminate as shown.

$$\mathbf{A}^d = \sum \mathbf{T}_k^T \mathbf{Q}_k^d \mathbf{T}_k t_k$$

where  $\mathbf{T}_k$  is the transformation matrix for the strain vector, and  $\mathbf{Q}_k^d$  is the in-plane secant stiffness of  $k^{\text{th}}$  layer in the principal orthotropic plane, and  $t_k$  is the thickness of the  $k^{\text{th}}$  layer of an n-layered laminate.

A physically-based and yet simple approach has been employed here to derive the damaged stiffness matrix. Two reduction coefficients,  $R_f$  and  $R_m$ , that represent the reduction of stiffness in the longitudinal (fiber) and transverse (matrix) directions have been employed. The shear modulus has also been reduced by the matrix reduction parameter. The major and minor Poisson's ratios have been reduced by  $R_f$  and  $R_m$  respectively. A sub-laminate-level reduction,  $R_L$ , is incorporated to avoid spurious stress locking in the damaged zone. This would lead to an effective reduced stiffness matrix  $\mathbf{Q}_k^d$ . The reduction coefficients are equal to 1 in the undamaged condition and gradually decrease to 0 for a saturated damage condition.

$$\mathbf{Q}_k^d = R_L \begin{bmatrix} \frac{R_f E_1}{1 - R_f R_m \nu_{12} \nu_{21}} & \frac{R_f R_m \nu_{12} E_2}{1 - R_f R_m \nu_{12} \nu_{21}} & 0 \\ \frac{R_m E_2}{1 - R_f R_m \nu_{12} \nu_{21}} & & 0 \\ \text{SYM} & & R_m G_{12} \end{bmatrix}_k$$

where  $E1$ ,  $E2$ ,  $\nu_{12}$ ,  $\nu_{21}$ , and  $G_{12}$  are the elastic constants of the lamina.

### Damage Evolution

In CODAM2, the evolution of damage mechanisms are expressed in terms of equivalent strain parameters. The equivalent strain function that governs the fiber stiffness reduction parameter is written in terms of the longitudinal normal strains by

$$\varepsilon_{f,k}^{eq} = \varepsilon_{11,k} \quad ; k = 1 \dots n$$

The equivalent strain function that governs the matrix stiffness reduction parameter is written in an interactive form in terms of the transverse and shear components of the local strain.

$$\varepsilon_{m,k}^{eq} = \text{sign}(\varepsilon_{22,k}) \sqrt{\left(\varepsilon_{22,k}\right)^2 + \left(\frac{\gamma_{12,k}}{2}\right)^2} \quad ; k = 1 \dots n$$

The sign of the transverse normal strain plays a very important role in the initiation and growth of damage since it indicates the compressive or tensile nature of the transverse stress. Therefore, the equivalent strain for the matrix damage carries the sign of the transverse normal strain.

Evolution of the overall damage mechanism (anti-locking) is written in terms of the maximum principal strains.

$$\varepsilon_L^{eq} = \max(\text{prn}(\boldsymbol{\varepsilon}))$$

Within the framework of non-local strain-softening formulations adopted here, all damage modes, be it intra-laminar (i.e. fiber and matrix damage) or overall sub-laminate modes are considered to be a function of the non-local (averaged) equivalent strain defined as:

$$\bar{\varepsilon}_\alpha^{eq} = \int_{\Omega_x} \varepsilon_\alpha^{eq}(\mathbf{x}) \cdot w_\alpha(\mathbf{X} - \mathbf{x}) \cdot d\Omega$$

where the subscript  $\alpha$  denotes the mode of damage: fiber ( $\alpha = f$ ) and matrix ( $\alpha = m$ ) damage in each layer,  $k$ , within the sub-laminate or associated with the overall sub-laminate, namely, locking ( $\alpha = L$ ). Thus, for a given sub-laminate with  $n$  layers,  $\varepsilon_\alpha^{eq}$  and  $\bar{\varepsilon}_\alpha^{eq}$  are vectors of size  $2n + 1$ .  $\mathbf{X}$  represents the position vector of the original point of interest and  $\mathbf{x}$  denotes the position vector of all other points (Gauss points) in the averaging zone denoted by  $\Omega$ . In classical isotropic non-local averaging approach, this zone is taken to be spherical (or circular in 2D) with a radius of  $r$  (named R1 in the material input card). The parameter,  $r$ , which affects the size of the averaging zone, introduces a length scale into the model that is linked directly to the predicted size of the damage zone. Averaging is done with a bell-shaped weight function,  $w_\alpha$ , evaluated by

$$w_\alpha = \left[ 1 - \left( \frac{d}{r} \right)^2 \right]^2$$

where  $d$  is the distance from the integration point of interest to another integration point with the averaging zone.

The damage parameters,  $\omega$ , are calculated as a function of the corresponding averaged equivalent strains. In CODAM2 the damage parameters are assumed to grow as a hyperbolic function of the damage potential (non-local equivalent strains) such that when used in conjunction with stiffness reduction factors that vary linearly with the damage parameters they result in a linear strain-softening response (or a bilinear stress-strain curve) for each mode of damage

$$\omega_\alpha = \frac{\left( \left| \bar{\varepsilon}_\alpha^{eq} \right| - \varepsilon_\alpha^i \right) \varepsilon_\alpha^s}{\left( \varepsilon_\alpha^s - \varepsilon_\alpha^i \right) \left| \bar{\varepsilon}_\alpha^{eq} \right|} \quad ; \quad \text{for } \left( \left| \bar{\varepsilon}_\alpha^{eq} \right| - \varepsilon_\alpha^i \right) > 0$$

where superscripts  $i$  and  $s$  denote, respectively, the damage initiation and saturation values of the strain quantities to which they are assigned. The initiation and saturation parameters are defined in material cards #6 and #7. Damage is considered to be a monotonically increasing function of time,  $t$ , such that

$$\omega_\alpha = \max \left[ \omega_\alpha^\tau \mid \tau \leq t, \omega_\alpha^t \right]$$

where  $\omega_\alpha^t$  is the value of  $\omega_\alpha$  for the current time (load state), and  $\omega_\alpha^\tau$  represents the state of damage at previous times  $\tau \leq t$ .

Damage is applied by scaling the layer stress by reduction parameters  $R_\alpha = 1 - \omega_\alpha$  where  $\alpha = f$  and  $\alpha = m$ . The layer stresses are summed and then then scaled by reduction parameter  $R_L = 1 - \omega_L$ . Figures (219.1) and (219.2) show the relationship between the damage and reduction parameters

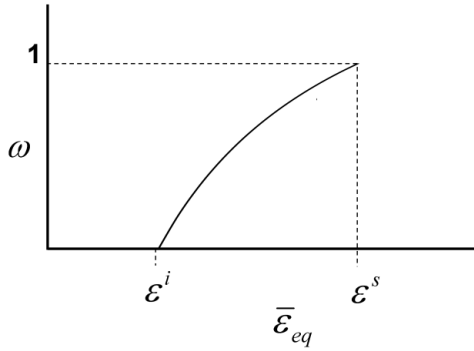

Figure 219.1 Damage parameter

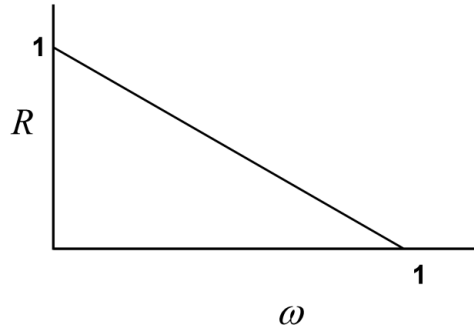

Figure 219.2 Reduction parameter

If the parameter RESIDS>0, damage in the layers is limited such that

$$R_f = \max(RESIDS, 1 - \omega_f)$$

$$R_m = \max(RESIDS, 1 - \omega_m)$$

### Element Erosion

When ERODE>0, an erosion criterion is checked at each integration point. Shell elements and thick shell elements will be deleted when the erosion criterion has been met at all integration points. Brick elements will be deleted when the erosion criterion is met at any of the integration points. For ERODE=1, the erosion criterion is met when maximum principal strain exceeds either SLOCT\*ERPAR1 for elements in tension, or SLOCC\*ERPAR1 for elements in compression. Elements are in tension when the magnitude of the first principal strain is greater than the magnitude of the third principal strain and in compression when the third principal strain is larger. When R>0, the ERODE=1 criterion is checked using the non-local (averaged) principal strain. For ERODE=2, the erosion criterion is met when the local (non-averaged) maximum principal strain exceeds ERPAR2. For ERODE=3, both of these erosion criteria are checked. For visualization purposes, the ratio of the maximum principal strain over the limit is stored in the location of plastic strain which is written by default to the ELOUT and D3PLOT files.

### History Variables

History variables for CODAM2 are listed in Table 219.1. To include them in the D3PLOT database, use NEIPH (bricks) or NEIPS (shells) on \*DATABASE\_EXTENT\_BINARY. For brick elements, add 4 to the variable numbers in the table because the first 6 history variables are reserved.

Variable Number	Description	Group
1,2	Reserved	
3	Overall (anti-locking) Damage	<b>Damage Parameters</b>
4	Delamination Damage (for visualization only)	
5	Fiber damage in the first layer	
6	Matrix damage in the first layer	
7	Fiber damage in the second layer	
8	Matrix damage in the second layer	
...	....	
3+2*NLAYER	Fiber damage in the last layer	
4+2*NLAYER	Matrix damage in the last layer	<b>Equivalent Strains used to evaluate damage (averaged if R1&gt;0)</b>
5+2*NLAYER	$\epsilon_R^{eq}$	
6+2*NLAYER	$\epsilon_{f,1}^{eq}$	
7+2*NLAYER	$\epsilon_{m,1}^{eq}$	
8+2*NLAYER	$\epsilon_{f,2}^{eq}$	
9+2*NLAYER	$\epsilon_{m,2}^{eq}$	
...	...	
4+4*NLAYER	$\epsilon_{f,n}^{eq}$	
5+4*NLAYER	$\epsilon_{m,n}^{eq}$	<b>Total Strain</b>
6+4*NLAYER	$\epsilon_x$	
7+4*NLAYER	$\epsilon_y$	
8+4*NLAYER	$\epsilon_z$	
9+4*NLAYER	$\gamma_{xy}$	
10+4*NLAYER	$\gamma_{yz}$	
11+4*NLAYER	$\gamma_{zx}$	

Table 219.1. History variables

**\*MAT\_RIGID\_DISCRETE**

This is Material Type 220. This is a rigid material which is discretized into multiple disjoint pieces. Each rigid piece can contain an arbitrary number of nodal points, shell, and solid elements that are arranged in an arbitrary shape. Rigid body mechanics is used to update each disjoint piece of any part ID which references this material type. The inertia properties for the disjoint pieces are determined directly from the finite element discretization. This material option can be used to model granular material where the grains interact through an automatic single surface contact definition. Another possible use includes modeling bolts as rigid bodies where the bolts belong to the same part ID. This model eliminates the need to represent each rigid piece with a unique part ID.

Card                    1                    2                    3                    4                    5                    6                    7                    8

Variable	MID	RO	E	PR				
Type	A8	F	F	F				
Default	none	none	none	none				

<u>VARIABLE</u>	<u>DESCRIPTION</u>
MID	Material identification. A unique number or label not exceeding 8 characters must be specified.
RO	Mass density.
E	Young's modulus.
PR	Poisson's ratio.



\*MAT\_ORTHOTROPIC\_SIMPLIFIED\_DAMAGE

This is Material Type 221. An orthotropic material with optional simplified damage and optional failure for composites can be defined. This model is valid only for 3D solid elements, with reduced or full integration. The elastic behavior is the same as MAT\_022. Nine damage variables are defined, applicable to Ea, Eb, Ec, (damage is different in tension and compression), and Gab, Gbc and Gca. In addition, nine failure criteria on strains are available. When failure occurs, elements are deleted (erosion). Failure depends on the number of integration points failed through the element. See the material description below.

Card 1            1            2            3            4            5            6            7            8

Variable	MID	RO	EA	EB	EC	PRBA	PRCA	PRCB
Type	A8	F	F	F	F	F	F	F
Default	none	None	none	none	none	none	none	none

Card 2            1            2            3            4            5            6            7            8

Variable	GAB	GBC	GCA		AOPT	MACF		
Type	F	F	F		F	I		
Default	none	None	none		0.0	0		

Card 3            1            2            3            4            5            6            7            8

Variable	XP	YP	ZP	A1	A2	A3		
Type	F	F	F	F	F	F		
Default	0.0	0.0	0.0	0.0	0.0	0.0		

# \*MAT\_221

# \*MAT\_ORTHOTROPIC\_SIMPLIFIED\_DAMAGE

Card 4            1            2            3            4            5            6            7            8

Variable	V1	V2	V3	D1	D2	D3	BETA	
Type	F	F	F	F	F	F	F	
Default	0.0	0.0	0.0	0.0	0.0	0.0	0.0	

Card 5            1            2            3            4            5            6            7            8

Variable	NERODE	NDAM	EPS1TF	EPS2TF	EPS3TF	EPS1CF	EPS2CF	EPS3CF
Type	I	I	F	F	F	F	F	F
Default	0	0	1.E20	1.E20	1.E20	-1.E20	-1.E20	-1.E20

Card 6            1            2            3            4            5            6            7            8

Variable	EPS12F	EPS23F	EPS13F	EPSD1T	DPSC1T	CDAM1T	EPS2DT	EPSC2T
Type	F	F	F	F	F	F	F	F
Default	1.E20	1.E20	1.E20	0.	0.	0.	0.	0.

Card 7            1            2            3            4            5            6            7            8

Variable	CDAM2T	EPSD3T	EPSC3T	CDAM3T	EPSD1C	EPSC1C	CDAM1C	EPSD2C
Type	I	I	F	F	F	F	F	F
Default	0.	0.	0.	0.	0.	0.	0.	0.

Card 8            1            2            3            4            5            6            7            8

Variable	EPSC2C	CDAM2C	EPSD3C	EPSC3C	CDAM3C	EPSD12	EPSC12	CDAM12
Type	F	F	F	F	F	F	F	F
Default	0.	0.	0.	0.	0.	0.	0.	0.

Card 9            1            2            3            4            5            6            7            8

Variable	EPSD23	EPSC23	CDAM23	EPSD31	EPSC31	CDAM31		
Type	F	F	F	F	F	F		
Default	0.	0.	0.	0.	0.	0.		

<u>VARIABLE</u>	<u>DESCRIPTION</u>
MID	Material identification. A unique number or label not exceeding 8 characters must be specified.
RO	Mass density
EA	$E_a$ , Young's modulus in a-direction.
EB	$E_b$ , Young's modulus in b-direction.
EC	$E_c$ , Young's modulus in c-direction.
PRBA	$\nu_{ba}$ , Poisson ratio, ba.
PRCA	$\nu_{ca}$ , Poisson ratio, ca.
PRCB	$\nu_{cb}$ , Poisson ratio, cb.
GAB	$G_{ab}$ , Shear modulus, ab.
GBC	$G_{bc}$ , Shear modulus, bc.
GCA	$G_{ca}$ , Shear modulus, ca.

<u>VARIABLE</u>	<u>DESCRIPTION</u>
AOPT	<p>Material axes option (see <i>MAT_OPTION TROPIC_ELASTIC</i> for a more complete description):</p> <p>EQ. 0.0: locally orthotropic with material axes determined by element nodes 1, 2, and 4, as with <i>*DEFINE_COORDINATE_NODES</i>.</p> <p>EQ. 1.0: locally orthotropic with material axes determined by a point in space and the global location of the element center; this is the a-direction. This option is for solid elements only.</p> <p>EQ. 2.0: globally orthotropic with material axes determined by vectors defined below, as with <i>*DEFINE_COORDINATE_VECTOR</i>.</p> <p>EQ. 3.0: locally orthotropic material axes determined by rotating the material axes about the element normal by an angle, BETA, from a line in the plane of the element defined by the cross product of the vector <b>v</b> with the element normal.</p> <p>EQ. 4.0: locally orthotropic in cylindrical coordinate system with the material axes determined by a vector <b>v</b>, and an originating point, P, which define the centerline axis. This option is for solid elements only.</p> <p>LT.0.0: the absolute value of AOPT is a coordinate system ID number (CID on <i>*DEFINE_COORDINATE_NODES</i>, <i>*DEFINE_COORDINATE_SYSTEM</i> or <i>*DEFINE_COORDINATE_VECTOR</i>).</p>
MACF	<p>Material axes change flag for brick elements:</p> <p>EQ.1: No change, default, EQ.2: switch material axes a and b, EQ.3: switch material axes a and c, EQ.4: switch material axes b and c.</p>
XP,YP,ZP	Coordinates of point <b>p</b> for AOPT = 1.
A1,A2,A3	Components of vector <b>a</b> for AOPT = 2.
V1,V2,V3	Components of vector <b>v</b> for AOPT = 3.
D1,D2,D3	Components of vector <b>d</b> for AOPT = 2.
BETA	Material angle in degrees for AOPT = 3, may be overridden on the element card, see <i>*ELEMENT_SOLID_ORTHO</i> .

VARIABLE	DESCRIPTION
NERODE	Failure and erosion flag: EQ. 0: No failure (default) EQ. 1: Failure as soon as one failure criterion is reached in all integration points EQ. 2: Failure as soon as one failure criterion is reached in at least one integration point EQ. 3: Failure as soon as a tension or compression failure criterion in the a-direction is reached for one integration point EQ. 4: Failure as soon as a tension or compression failure criterion in the b-direction is reached for one integration point EQ. 5: Failure as soon as a tension or compression failure criterion in the c-direction is reached for one integration point EQ. 6: Failure as soon as tension or compression failure criteria in both the a- and b-directions are reached at a single integration point or at 2 different integration points EQ. 7: Failure as soon as tension or compression failure criteria in both the b- and c-directions are reached at a single integration point or at 2 different integration points EQ. 8: Failure as soon as tension or compression failure criteria in both the a- and c-directions are reached at a single integration point or at 2 different integration points EQ. 9: Failure as soon as tension or compression failure criteria in the 3 directions are reached at a single integration point or at different integration points
NDAM	Damage flag: EQ. 0: No damage (default) EQ. 1: Damage in tension only (null for compression) EQ. 2: Damage in tension and compression
EPS1TF	Failure strain in tension along the a-direction
EPS2TF	Failure strain in tension along the b-direction
EPS3TF	Failure strain in tension along the c-direction
EPS1CF	Failure strain in compression along the a-direction
EPS2CF	Failure strain in compression along the b-direction
EPS3CF	Failure strain in compression along the c-direction
EPS12F	Failure shear strain in the ab-plane
EPS23F	Failure shear strain in the bc-plane

<b>VARIABLE</b>	<b>DESCRIPTION</b>
EPS13F	Failure shear strain in the ac-plane
EPD1T	Damage threshold in tension along the a-direction, $\varepsilon_{1t}^s$
EPSC1T	Critical damage threshold in tension along the a-direction, $\varepsilon_{1t}^c$
CDAM1T	Critical damage in tension along the a-direction, $D_{1t}^c$
EPS2DT	Damage threshold in tension along the b-direction, $\varepsilon_{2t}^s$
EPSC2T	Critical damage threshold in tension along the b-direction, $\varepsilon_{2t}^c$
CDAM2T	Critical damage in tension along the b-direction, $D_{2t}^c$
EPD3T	Damage threshold in tension along the c-direction, $\varepsilon_{3t}^s$
EPSC3T	Critical damage threshold in tension along the c-direction, $\varepsilon_{3t}^c$
CDAM3T	Critical damage in tension along the c-direction, $D_{3t}^c$
EPD1C	Damage threshold in compression along the a-direction, $\varepsilon_{1c}^s$
EPSC1C	Critical damage threshold in compression along the a-direction, $\varepsilon_{1c}^c$
CDAM1C	Critical damage in compression along the a-direction, $D_{1c}^c$
EPD2C	Damage threshold in compression along the b-direction, $\varepsilon_{2c}^s$
EPSC2C	Critical damage threshold in compression along the b-direction, $\varepsilon_{2c}^c$
CDAM2C	Critical damage in compression along the b-direction, $D_{2c}^c$
EPD3C	Damage threshold in compression along the c-direction, $\varepsilon_{3c}^s$
EPSC3C	Critical damage threshold in compression along the c-direction, $\varepsilon_{3c}^c$
CDAM3C	Critical damage in compression along the c-direction, $D_{3c}^c$
EPD12	Damage threshold for shear in the ab-plane, $\varepsilon_{12}^s$
EPSC12	Critical damage threshold for shear in the ab-plane, $\varepsilon_{12}^c$
CDAM12	Critical damage for shear in the ab-plane, $D_{12}^c$
EPD23	Damage threshold for shear in the bc-plane, $\varepsilon_{23}^s$
EPSC23	Critical damage threshold for shear in the bc-plane, $\varepsilon_{23}^c$

VARIABLE	DESCRIPTION
CDAM23	Critical damage for shear in the bc-plane, $D_{23}^c$
EPSD31	Damage threshold for shear in the ac-plane, $\varepsilon_{31}^s$
EPSC31	Critical damage threshold for shear in the ac-plane, $\varepsilon_{31}^c$
CDAM31	Critical damage for shear in the ac-plane, $D_{31}^c$

**Remarks:**

If  $\varepsilon_k < \varepsilon_k^s$ , no damage is considered. Failure occurs only when failure strain is reached.

Failure can occur along the 3 orthotropic directions, in tension, in compression and for shear behavior. Nine failure strains drive the failure. When failure occurs, elements are deleted (erosion). Under the control of the NERODE flag, failure may occur either when only one integration point has failed, when several integration points have failed or when all integrations points have failed.

Damage applies to the 3 Young's moduli and the 3 shear moduli. Damage is different for tension and compression. Nine damage variables are used:  $d_{1t}$ ,  $d_{2t}$ ,  $d_{3t}$ ,  $d_{1c}$ ,  $d_{2c}$ ,  $d_{3c}$ ,  $d_{12}$ ,  $d_{23}$ ,  $d_{13}$ . The damaged flexibility matrix is:

$$S^{dam} = \begin{pmatrix} \frac{1}{E_a(1-d_{1t/c})} & \frac{-\nu_{ba}}{E_b} & \frac{-\nu_{ca}}{E_c} & 0 & 0 & 0 \\ \frac{-\nu_{ba}}{E_b} & \frac{1}{E_b(1-d_{2t/c})} & \frac{-\nu_{cb}}{E_c} & 0 & 0 & 0 \\ \frac{-\nu_{ca}}{E_c} & \frac{-\nu_{cb}}{E_c} & \frac{1}{E_c(1-d_{3t/c})} & 0 & 0 & 0 \\ 0 & 0 & 0 & \frac{1}{G_{ab}(1-d_{12})} & 0 & 0 \\ 0 & 0 & 0 & 0 & \frac{1}{G_{bc}(1-d_{23})} & 0 \\ 0 & 0 & 0 & 0 & 0 & \frac{1}{G_{ca}(1-d_{31})} \end{pmatrix}$$

The nine damage variables are calculated as follows:

$$d_k = \max \left( d_k^c ; D_k^c \left\langle \frac{\varepsilon_k - \varepsilon_k^s}{\varepsilon_k^c - \varepsilon_k^s} \right\rangle_+ \right)$$

with  $k = 1t, 2t, 3t, 1c, 2c, 3c, 12, 23, 31$ .

$$\langle \cdot \rangle_+ \text{ is the positive part: } \langle x \rangle_+ = \begin{cases} x & \text{if } x > 0 \\ 0 & \text{if } x < 0 \end{cases}$$

Damage in compression may be deactivated with the NDAM flag. In this case, damage in compression is null, and only damage in tension and for shear behavior are taken into account.

The nine damage variables may be post-processed through additional variables. The number of additional variables for solids written to the d3plot and d3thdt databases is input by the optional \*DATABASE\_EXTENT\_BINARY card as variable NEIPH. These additional variables are tabulated below:

History Variable	Description	Value	LS-Prepost history variable
$d_{1t}$	<i>damage in traction along a</i>	$0 - \text{no damage}$ $0 < d_k \leq D_k^c - \text{damage}$	<i>plastic strain</i>
$d_{2t}$	<i>damage in traction along b</i>		1
$d_{3t}$	<i>damage in traction along c</i>		2
$d_{1c}$	<i>damage in compression along a</i>		3
$d_{2c}$	<i>damage in compression along b</i>		4
$d_{3c}$	<i>damage in compression along c</i>		5
$d_{12}$	<i>shear damage in ab-plane</i>		6
$d_{23}$	<i>shear damage in bc-plane</i>		7
$d_{13}$	<i>shear damage in ac-plane</i>		8

The first damage variable is stored as in the place of effective plastic strain. The eight other damage variables may be plotted in LS-Prepost as element history variables.



\*MAT\_TABULATED\_JOHNSON\_COOK

This is Material Type 224. An elasto-viscoplastic material with arbitrary stress versus strain curve(s) and arbitrary strain rate dependency can be defined. Plastic heating causes adiabatic temperature increase and material softening. Optional plastic failure strain can be defined as a function of triaxiality, strain rate, temperature and/or element size. This material model resembles the original Johnson-Cook material (see \*MAT\_015) but with the possibility of general tabulated input parameters. The model is available for shell and solid elements.

Card 1            1            2            3            4            5            6            7            8

Variable	MID	RO	E	PR	CP	TR	BETA	NUMINT
Type	A8	F	F	F	F	F	F	F
Default	none	none	none	none	none	0.0	1.0	1.0

Card 2            1            2            3            4            5            6            7            8

Variable	LCK1	LCKT	LCF	LCG	LCH	LCI		
Type	F	F	F	F	F	F		
Default	0	0	0	0	0	0		

<u>VARIABLE</u>	<u>DESCRIPTION</u>
MID	Material identification. A unique number or label not exceeding 8 characters must be specified.
RO	Mass density.
E	Young's modulus: GT.0.0: constant value is used LT.0.0: temperature dependent Young's modulus given by load curve ID = -E (starting with release 971 R6)
PR	Poisson's ratio.
CP	Specific heat.

VARIABLE	DESCRIPTION
TR	Room temperature.
BETA	Amount of plastic work converted into heat.
NUMINT	Number of integration points which must fail before the element is deleted. Available for shells and solids. LT.0.0:  NUMINT  is percentage of integration points/layers which must fail before shell element fails. For fully integrated shells, a methodology is used where a layer fails if one integration point fails and then the given percentage of layers must fail before the element fails. Only available for shells.
LCK1	Load curve ID or Table ID. The load curve ID defines effective stress as a function of effective plastic strain. The table ID defines for each plastic strain rate value a load curve ID giving the (isothermal) effective stress versus effective plastic strain for that rate.
LCKT	Table ID defining for each temperature value a load curve ID giving the (quasi-static) effective stress versus effective plastic strain for that temperature.
LCF	Load curve ID or Table ID. The load curve ID defines plastic failure strain as a function of triaxiality. The table ID defines for each Lode parameter a load curve ID giving the plastic failure strain versus triaxiality for that Lode parameter. (Table option only for solids and not yet generally supported).
LCG	Load curve ID defining plastic failure strain as a function of strain rate.
LCH	Load curve ID defining plastic failure strain as a function of temperature
LCI	Load curve ID defining plastic failure strain as a function of element size.

**Remarks:**

The flow stress  $\sigma_y$  is expressed as a function of plastic strain  $\epsilon_p$ , plastic strain rate  $\dot{\epsilon}_p$  and temperature  $T$  via the following formula (using load curves/tables LCK1 and LCKT):

$$\sigma_y = k1(\epsilon_p, \dot{\epsilon}_p) \cdot kt(\epsilon_p, T)$$

Optional plastic failure strain is defined as a function of triaxiality  $p / \sigma_{vm}$ , Lode parameter, plastic strain rate  $\dot{\epsilon}_p$ , temperature  $T$  and element size  $l_0$  (square root of element area for shells and volume over maximum area for solids) by

$$\varepsilon_{pf} = f \left( \frac{p}{\sigma_{vm}}, \frac{(27J_3)}{\sqrt{2\sigma_{vm}^3}} \right) g(\dot{\varepsilon}_p) h(T) i(l_c)$$

using load curves/tables LCF, LCG, LCH and LCI. A typical failure curve LCF for metal sheet, modeled with shell elements is shown in Figure 224.1. Triaxiality should be monotonically increasing in this curve. A reasonable range for triaxiality is  $-2/3$  to  $2/3$  if shell elements are used (plane stress). For 3-dimensional stress states (solid elements), the possible range of triaxiality goes from  $-\infty$  to  $+\infty$ , but to get a good resolution in the internal load curve discretization (depending on parameter LCINT of \*CONTROL\_SOLUTION) one should define lower limits, e.g.  $-1$  to  $1$  if LCINT=100 (default).

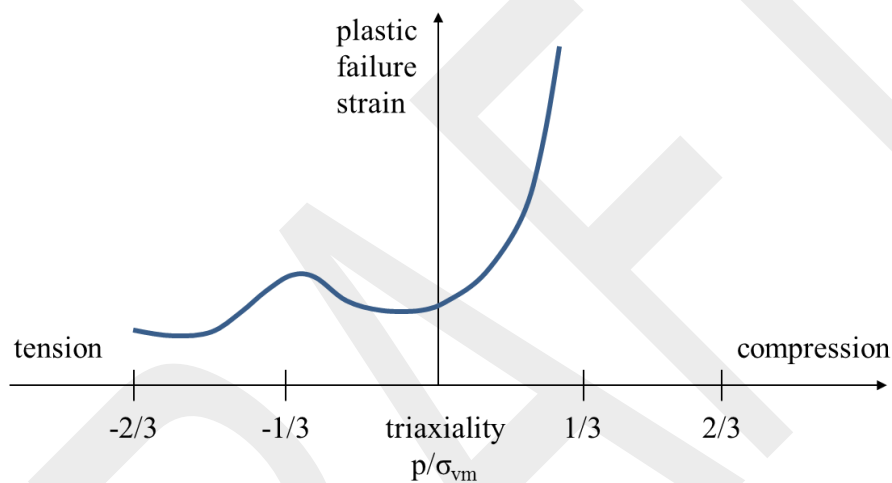

**Figure 224.1.** Typical failure curve for metal sheet, modeled with shell elements.

Temperature increase is caused by plastic work

$$T = T_R + \frac{\beta}{C_p \rho} \int \sigma_y \dot{\varepsilon}_p$$

with room temperature  $T_R$ , dissipation factor  $\beta$ , specific heat  $C_p$ , and density  $\rho$ .

History variables may be post-processed through additional variables. The number of additional variables for shells/solids written to the d3plot and d3thdt databases is input by the optional \*DATABASE\_EXTENT\_BINARY card as variable NEIPS/NEIPH. The relevant additional variables of this material model are tabulated below:

<b>LS-Prepost history variable #</b>	<b>Shell elements</b>	<b>LS-Prepost history variable #</b>	<b>Solid elements</b>
<i>1</i>	<i>plastic strain rate</i>	<i>5</i>	<i>plastic strain rate</i>
<i>7</i>	<i>plastic work</i>	<i>8</i>	<i>plastic failure strain</i>
<i>8</i>	<i>ratio of plastic strain to plastic failure strain</i>	<i>9</i>	<i>triaxiality</i>
<i>9</i>	<i>element size</i>	<i>10</i>	<i>Lode parameter</i>
<i>10</i>	<i>temperature</i>	<i>11</i>	<i>plastic work</i>
<i>11</i>	<i>plastic failure strain</i>	<i>12</i>	<i>ratio of plastic strain to plastic failure strain</i>
<i>12</i>	<i>triaxiality</i>	<i>13</i>	<i>element size</i>
		<i>14</i>	<i>temperature</i>

\*MAT\_VISCOPLASTIC\_MIXED\_HARDENING

This is Material Type 225. An elasto-viscoplastic material with an arbitrary stress versus strain curve and arbitrary strain rate dependency can be defined. Kinematic, isotropic, or a combination of kinematic and isotropic hardening can be specified. Also, failure based on plastic strain can be defined.

Card 1            1            2            3            4            5            6            7            8

Variable	MID	RO	E	PR	LCSS	BETA		
Type	A8	F	F	F	I	F		
Default	none	none	none	none	none	0.0		

Card 2            1            2            3            4            5            6            7            8

Variable	FAIL							
Type	F							
Default	1.0E+20							

<u>VARIABLE</u>	<u>DESCRIPTION</u>
MID	Material identification. A unique number or label not exceeding 8 characters must be specified.
RO	Mass density.
E	Young's modulus.
PR	Poisson's ratio.

<u>VARIABLE</u>	<u>DESCRIPTION</u>
LCSS	Load curve ID or Table ID. Load curve ID defining effective stress versus effective plastic strain The table ID defines for each strain rate value a load curve ID giving the stress versus effective plastic strain for that rate, See Figure 24.1. The stress versus effective plastic strain curve for the lowest value of strain rate is used if the strain rate falls below the minimum value. Likewise, the stress versus effective plastic strain curve for the highest value of strain rate is used if the strain rate exceeds the maximum value. NOTE: The strain rate values defined in the table may be given as the natural logarithm of the strain rate. If the <i>first</i> stress-strain curve in the table corresponds to a negative strain rate, LS-DYNA assumes that the natural logarithm of the strain rate value is used. Since the tables are internally discretized to equally space the points, natural logarithms are necessary, for example, if the curves correspond to rates from 10.e-04 to 10.e+04.
BETA	Hardening parameter, 0<BETA<1. EQ.0.0: Pure kinematic hardening EQ.1.0: Pure isotropic hardening 0.0<BETA<1.0: Mixed hardening
FAIL	Failure flag. LT.0.0: User defined failure subroutine is called to determine failure EQ.0.0: Failure is not considered. This option is recommended if failure is not of interest since many calculations will be saved. GT.0.0: Plastic strain to failure. When the plastic strain reachesthis value, the element is deleted from the calculation..

**\*MAT\_KINEMATIC\_HARDENING\_BARLAT89**

This is Material Type 226. This model combines Yoshida non-linear kinematic hardening rule (\*MAT\_125) with the 3-parameter material model of Barlat and Lian [1989] (\*MAT\_36) to model metal sheets under cyclic plasticity loading and with anisotropy in plane stress condition. Lankford parameters are used for the definition of the anisotropy. Yoshida's theory describes the hardening rule with 'two surfaces' method: the yield surface and the bounding surface. In the forming process, the yield surface does not change in size, but its center moves with deformation; the bounding surface changes both in size and location.

Card 1            1            2            3            4            5            6            7            8

Variable	MID	RO	E	PR	M	R00	R45	R90
Type	I	F	F	F	F	F	F	F
Default	none	0.0	0.0	0.0	0.0	0.0	0.0	none

Card 2            1            2            3            4            5            6            7            8

Variable	CB	Y	SC	K	RSAT	SB	H	HLCID
Type	F	F	F	F	F	F	F	I
Default	0.0	0.0	0.0	0.0	0.0	0.0	0.0	none

Card 3            1            2            3            4            5            6            7            8

Variable	AOPT	IOPT	C1	C2				
Type	F	I	F	F				
Default	none	none	0.0	0.0				

Card 4            1            2            3            4            5            6            7            8

Variable	XP	YP	ZP	A1	A2	A3		
Type	F	F	F	F	F	F		
Default	none	none	none	none	none	none		

Card 5            1            2            3            4            5            6            7            8

Variable	V1	V2	V3	D1	D2	D3	BETA	
Type	F	F	F	F	F	F	F	
Default	none	none	none	none	none	none	none	

**VARIABLE****DESCRIPTION**

MID	Material identification. A unique number must be specified.
RO	Mass density.
E	Young's modulus, E.
PR	Poisson's ratio, $\nu$ .
M	m, exponent in Barlat's yield criterion.
R <sub>00</sub>	R <sub>00</sub> , Lankford parameter in 0 degree direction.
R <sub>45</sub>	R <sub>45</sub> , Lankford parameter in 45 degree direction.
R <sub>90</sub>	R <sub>90</sub> , Lankford parameter in 90 degree direction.
CB	The uppercase B defined in the Yoshida's equations.
Y	Hardening parameter as defined in the Yoshida's equations.
SC	The lowercase c defined in the Yoshida's equations.
K	Hardening parameter as defined in the Yoshida's equations.



VARIABLE	DESCRIPTION
RSAT	Hardening parameter as defined in the Yoshida's equations.
SB	The lowercase b as defined in the Yoshida's equations.
H	Anisotropic parameter associated with work-hardening stagnation, defined in the Yoshida's equations.
HLCID	Load curve ID in keyword *DEFINE_CURVE, where true strain and true stress relationship is characterized. The load curve is optional, and is used for error calculation only.
IOPT	Kinematic hardening rule flag: EQ.0: Original Yoshida formulation, EQ.1: Modified formulation. Define C1, C2 as below.
C1, C2	Constants used to modify R: $R = RSAT \left[ (C_1 + \bar{\epsilon}^p)^{c_2} - C_1^{c_2} \right]$
AOPT	Material axes option (see MAT_OPTION TROPIC_ELASTIC for a more complete description): EQ.0.0: locally orthotropic with material axes determined by element nodes 1, 2, and 4, as with *DEFINE_COORDINATE_NODES, and then rotated about the shell element normal by the angle BETA.. EQ.2.0: globally orthotropic with material axes determined by vectors defined below, as with *DEFINE_COORDINATE_VECTOR. EQ.3.0: locally orthotropic material axes determined by rotating the material axes about the element normal by an angle, BETA, from a line in the plane of the element defined by the cross product of the vector v with the element normal. LT.0.0: the absolute value of AOPT is a coordinate system ID number (CID on *DEFINE_COORDINATE_NODES, *DEFINE_COORDINATE_SYSTEM or *DEFINE_COORDINATE_VECTOR). Available with the R3 release of Version 971 and later.
XP, YP, ZP	Coordinates of point <b>p</b> for AOPT = 1.
A1, A2, A3	Components of vector <b>a</b> for AOPT = 2.
V1, V2, V3	Components of vector <b>v</b> for AOPT = 3.
D1, D2, D3	Components of vector <b>d</b> for AOPT = 2.
BETA	Material angle in degrees for AOPT=0 and 3, may be overridden on the element card, see *ELEMENT_SHELL_BETA.

**Remarks:**

1. The R-values are defined as the ratio of instantaneous width change to instantaneous thickness change. That is, assume that the width W and thickness T are measured as function of strain. Then the corresponding R-value is given by:

$$R = \frac{\frac{dW}{d\varepsilon}/W}{\frac{dT}{d\varepsilon}/T}$$

Input R00, R45 and R90 to define sheet anisotropy in the rolling, 45 degree and 90 degree direction.

2. Barlat and Lian’s [1989] anisotropic yield criterion  $\Phi$  for plane stress is defined as:

$$\Phi = a|K_1 + K_2|^m + a|K_1 - K_2|^m + c|2K_2|^m = 2\sigma_Y^m$$

For face centered cubic (FCC) materials exponent m=8 is recommended and for body centered cubic (BCC) materials m=6 may be used. Detailed description on the criterion can be found in \*MAT\_036 manual pages.

3. The Yoshida’s model accounts for cyclic plasticity including Bauschinger effect and cyclic hardening behavior. For detailed Yoshida’s theory of nonlinear kinematic hardening rule and definitions of material constants CB, Y, SC, K, RSAT, SB, and H, refer to **Remarks** in \*MAT\_125 manual pages and in the original paper, “*A model of large-strain cyclic plasticity describing the Bauschinger effect and workhardening stagnation*”, by Yoshida, F. and Uemori, T., *Int. J. Plasticity*, vol. 18, 661-689, 2002.

Further improvements in the original Yoshida’s model, as described in a paper “*Determination of Nonlinear Isotropic/Kinematic Hardening Constitutive Parameter for AHSS using Tension and Compression Tests*”, by Shi, M.F., Zhu, X.H., Xia, C., and Stoughton, T., in *NUMISHEET 2008 proceedings*, 137-142, 2008, included modifications to allow work hardening in large strain deformation region, avoiding the problem of earlier saturation, especially for Advanced High Strength Steel (AHSS). These types of steels exhibit continuous strain hardening behavior and a non-saturated isotropic hardening function. As described in the paper, the evolution equation for R (a part of the current radius of the bounding surface in deviatoric stress space), as is with the saturation type of isotropic hardening rule proposed in the original Yoshida model,

$$\dot{R} = m(R_{sat} - R)\dot{p}$$

is modified as,

$$R = RSAT \left[ (C_1 + \bar{\varepsilon}^p)^{c_2} - C_1^{c_2} \right]$$

For saturation type of isotropic hardening rule, set IOPT=0, applicable to most of Aluminum sheet materials. In addition, the paper provides detailed variables used for this

material model for DDQ, HSLA, DP600, DP780 and DP980 materials. Since the symbols used in the paper are different from what are used here, the following table provides a reference between symbols used in the paper and variables here in this keyword:

B	Y	C	m	K	b	h	$e^0$	N
CB	Y	SC	K	Rsat	SB	H	C1	C2

Using the modified formulation and the material properties provided by the paper, the predicted and tested results compare very well both in a full cycle tension and compression test and in a pre-strained tension and compression test, according to the paper. A set of experiments are required to fit (optimize) the Yoshida material constants, and these experiments include a uniaxial tension test (used for HLCID), a full cycle tension and compression test and a multiple cycle tension and compression test.

Application of the modified Yoshida’s hardening rule in the metal forming industry has shown significant improvement in springback prediction accuracy, which is a prerequisite for a successful stamping tool compensation, especially for AHSS type of sheet materials.

- 4. The variable AOPT is used to define the rolling direction of the sheet metals. For shells, AOPT of 2 or 3 are relevant. When AOPT=2, define vector components of **a** in the direction of the rolling ( $R_{00}$ ); when AOPT=3, define vector components of **v** perpendicular to the rolling direction, as shown in the following Figure.

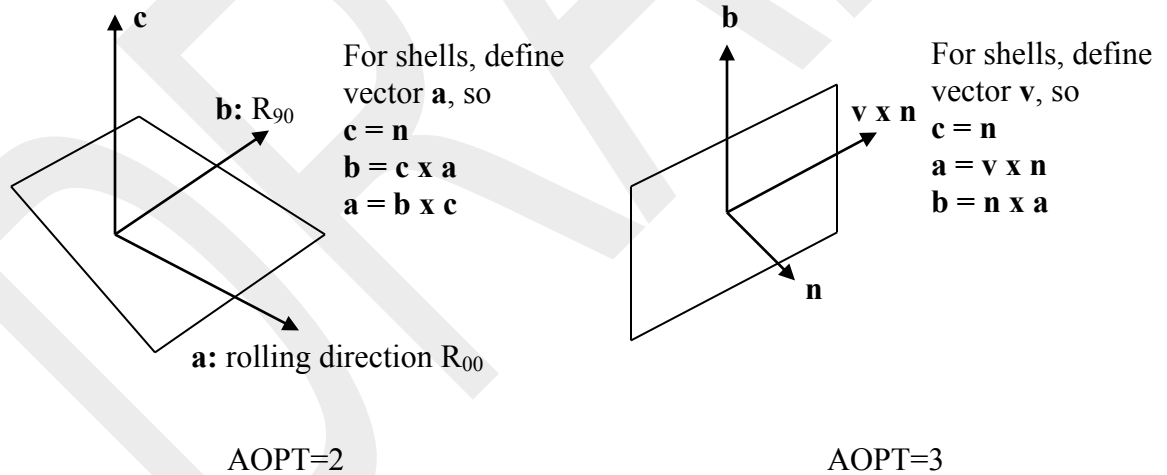

- 5. To improve convergence, it is recommended that \*CONTROL\_IMPLICIT\_FORMING type ‘1’ be used when conducting springback simulation.
- 6. In an example below, springback simulation results on the section Y=-370 mm from the NUMISHEET 2005 cross member using \*MAT\_226 show better springback correlation with measurements than \*MAT\_125 and \*MAT\_37.
- 7. This material model is available in LS-DYNA R5 Revision 57717 or later releases.

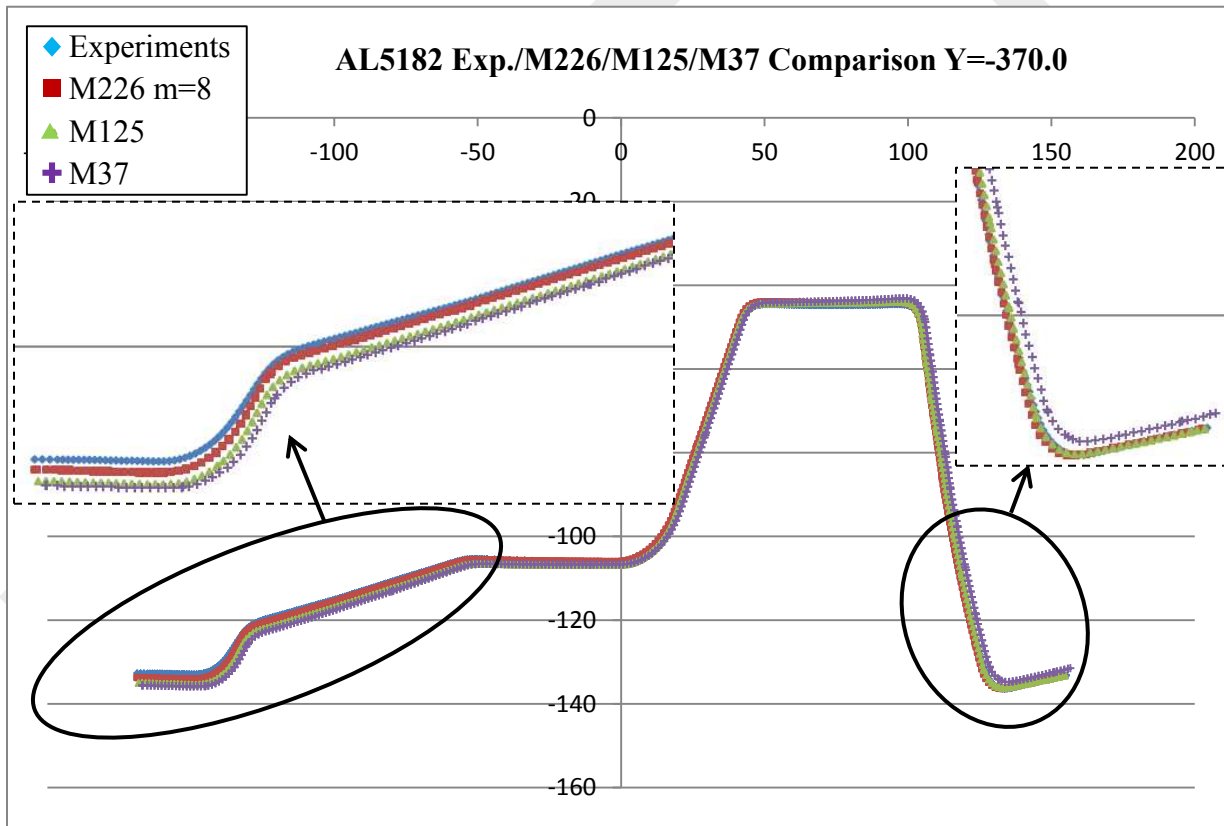
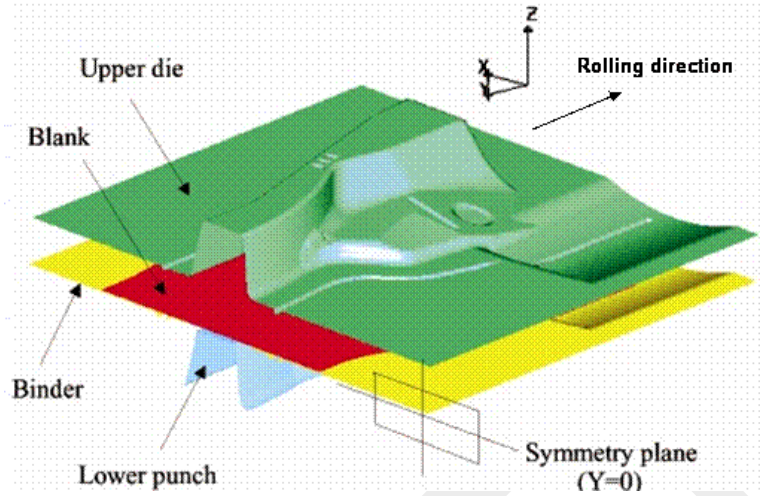

Springback prediction with \*MAT\_226 (Material properties courtesy of Ford Motor Company)

\*MAT\_PML\_ELASTIC

This is Material Type 230. This is a perfectly-matched layer (PML) material — an absorbing layer material used to simulate wave propagation in an unbounded isotropic elastic medium — and is available only for solid 8-node bricks (element type 2). This material implements the 3D version of the Basu-Chopra PML [Basu and Chopra (2003,2004), Basu (2009)].

Card            1            2            3            4            5            6            7            8

Variable	MID	RO	E	PR				
Type	A8	F	F	F				
Default	none	none	none	none				

<u>VARIABLE</u>	<u>DESCRIPTION</u>
MID	Material identification. A unique number or label not exceeding 8 characters must be specified.
RO	Mass density.
E	Young’s modulus.
PR	Poisson’s ratio.

**Remarks:**

1. A layer of this material may be placed at a boundary of a bounded domain to simulate unboundedness of the domain at that boundary: the layer absorbs and attenuates waves propagating outward from the domain, without any significant reflection of the waves back into the bounded domain. The layer cannot support any static displacement.
2. It is assumed the material in the bounded domain near the layer is, or behaves like, an isotropic linear elastic material. The material properties of the layer should be set to the corresponding properties of this material.
3. The layer should form a cuboid box around the bounded domain, with the axes of the box aligned with the coordinate axes. Various faces of this box may be open, as required by the geometry of the problem, e.g., for a half-space problem, the “top” of the box should be open.

4. Internally, LS-DYNA will partition the entire PML into regions which form the “faces”, “edges” and “corners” of the above cuboid box, and generate a new material for each region. This partitioning will be visible in the d3plot file. The user may safely ignore this partitioning.
5. The layer should have 5-10 elements through its depth. Typically, 5-6 elements are sufficient if the excitation source is reasonably distant from the layer, and 8-10 elements if it is close. The size of the elements should be similar to that of elements in the bounded domain near the layer, and should be small enough to sufficiently discretize all significant wavelengths in the problem.
6. The nodes on the outer boundary of the layer should be fully constrained.
7. The stress and strain values reported by this material do not have any physical significance.

**\*MAT\_PML\_ELASTIC\_FLUID**

This is Material Type 230\_FLUID. This is a perfectly-matched layer (PML) material with a pressure fluid constitutive law, to be used in a wave-absorbing layer adjacent to a fluid material (\*MAT\_ELASTIC\_FLUID) in order to simulate wave propagation in an unbounded fluid medium. See the Remarks sections of \*MAT\_PML\_ELASTIC (\*MAT\_230) and \*MAT\_ELASTIC\_FLUID (\*MAT\_001\_FLUID) for further details.

Card                    1                    2                    3                    4                    5                    6                    7                    8

Variable	MID	RO	K	VC				
Type	A8	F	F	F				
Default	none	none	none	none				

<u>VARIABLE</u>	<u>DESCRIPTION</u>
MID	Material identification. A unique number or label not exceeding 8 characters must be specified.
RO	Mass density
K	Bulk modulus
VC	Tensor viscosity coefficient

**\*MAT\_PML\_ACOUSTIC**

This is Material Type 231. This is a perfectly-matched layer (PML) material — an absorbing layer material used to simulate wave propagation in an unbounded acoustic medium — and can be used only with the acoustic pressure element formulation (element type 14). This material implements the 3D version of the Basu-Chopra PML for anti-plane motion [Basu and Chopra (2003,2004), Basu (2009)].

Card            1            2            3            4            5            6            7            8

Variable	MID	RO	C					
Type	A8	F	F					
Default	none	none	none					

<u>VARIABLE</u>	<u>DESCRIPTION</u>
MID	Material identification. A unique number or label not exceeding 8 characters must be specified.
RO	Mass density
C	Sound speed

**Remarks:**

1. A layer of this material may be placed at a boundary of a bounded domain to simulate unboundedness of the domain at that boundary: the layer absorbs and attenuates waves propagating outward from the domain, without any significant reflection of the waves back into the bounded domain. The layer cannot support any hydrostatic pressure.
2. It is assumed the material in the bounded domain near the layer is an acoustic material. The material properties of the layer should be set to the corresponding properties of this material.
3. The layer should form a cuboid box around the bounded domain, with the axes of the box aligned with the coordinate axes. Various faces of this box may be open, as required by the geometry of the problem, e.g., for a half-space problem, the “top” of the box should be open.
4. Internally, LS-DYNA will partition the entire PML into regions which form the “faces”, “edges” and “corners” of the above cuboid box, and generate a new material for each



region. This partitioning will be visible in the d3plot file. The user may safely ignore this partitioning.

5. The layer should have 5-10 elements through its depth. Typically, 5-6 elements are sufficient if the excitation source is reasonably distant from the layer, and 8-10 elements if it is close. The size of the elements should be similar to that of elements in the bounded domain near the layer, and should be small enough to sufficiently discretize all significant wavelengths in the problem.
6. The nodes on the outer boundary of the layer should be fully constrained.
7. The pressure values reported by this material do not have any physical significance.

**\*MAT\_BIOT\_HYSTERETIC**

This is Material Type 232. This is a Biot linear hysteretic material, to be used for modeling the nearly-frequency-independent viscoelastic behaviour of soils subjected to cyclic loading, e.g. in soil-structure interaction analysis [Spanos and Tsavachidis (2001), Makris and Zhang (2000), Muscolini, Palmeri and Ricciardelli (2005)]. The hysteretic damping coefficient for the model is computed from a prescribed damping ratio by calibrating with an equivalent viscous damping model for a single-degree-of-freedom system. The damping increases the stiffness of the model and thus reduces the computed time-step size.

Card            1            2            3            4            5            6            7            8

Variable	MID	RO	E	PR	ZT	FD		
Type	A8	F	F	F	F	F		
Default	none	none	none	none	0.0	3.25		

<u>VARIABLE</u>	<u>DESCRIPTION</u>
MID	Material identification. A unique number or label not exceeding 8 characters must be specified.
RO	Mass density.
E	Young's modulus.
PR	Poisson's ratio.
ZT	Damping ratio
FD	Dominant excitation frequency in Hz

**Remarks:**

1. The stress is computed as a function of the strain rate as

$$\sigma(t) = \int_0^t C_R(t - \tau) \dot{\epsilon}(\tau) d\tau$$

where

$$C_R(t) = C \left[ 1 + \frac{2\eta}{\pi} E_1(\beta t) \right]$$

with  $C$  being the elastic isotropic constitutive tensor,  $\eta$  the hysteretic damping factor, and  $\beta = 2\pi f_d / 10$ , where  $f_d$  is the dominant excitation frequency in Hz. The function  $E_1$  is given by

$$E_1(s) = \int_s^{\infty} \frac{e^{-\xi}}{\xi} d\xi$$

For efficient implementation, this function is approximated by a 5-term Prony series as

$$E_1(s) \approx \sum_{k=1}^5 b_k e^{a_k s}$$

such that  $b_k > 0$ .

2. The hysteretic damping factor  $\eta$  is obtained from the prescribed damping ratio  $\zeta$  as

$$\eta = \pi \zeta / \text{atan}(10) = 2.14 \zeta$$

by assuming that, for a single degree-of-freedom system, the energy dissipated per cycle by the hysteretic material is the same as that by a viscous damper, if the excitation frequency matches the natural frequency of the system.

3. The consistent Young's modulus for this model is given by

$$E_c = E \left[ 1 + \frac{2\eta}{\pi} g \right]$$

where

$$g = \sum_{k=1}^5 b_k \frac{1}{a_k \beta \Delta t_n} [\exp(a_k \beta \Delta t_n) - 1]$$

Because  $g > 0$ , the computed element time-step size is smaller than that for the corresponding elastic element. Furthermore, the time-step size computed at any time depends on the previous time-step size. It can be demonstrated that the new computed time-step size stays within a narrow range of the previous time-step size, and for a uniform mesh, converges to a constant value. For  $f_d = 3.25\text{Hz}$  and  $\zeta = 0.05$ , the percentage decrease in time-step size can be expected to be about 12-15% for initial time-step sizes of less than 0.02 secs, and about 7-10% for initial time-step sizes larger than 0.02 secs.

4. The default value of the dominant frequency is chosen to be valid for earthquake excitation.

**\*MAT\_CAZACU\_BARLAT**

This is Material Type 233. This material model is for Hexagonal Closed Packet (HCP) metals and is based on the work by Cazacu et al. (2006). This model is capable of describing the yielding asymmetry between tension and compression for such materials. Moreover, a parameter fit is optional and can be used to find the material parameters that describe the experimental yield stresses. The experimental data that the user should supply consists of yield stresses for tension and compression in the 00 direction, tension in the 45 and the 90 directions, and a biaxial tension test.

Card 1            1            2            3            4            5            6            7            8

Variable	MID	RO	E	PR	HR	P1	P2	ITER
Type	A8	F	F	F	F	F	F	F

Card 2            1            2            3            4            5            6            7            8

Variable	A	C11	C22	C33	LCID	E0	K	P3
Type	F	F	F	F	I	F	F	F

Card 3            1            2            3            4            5            6            7            8

Variable	AOPT				C12	C13	C23	C44
Type	F				F	F	F	F

Card 4            1            2            3            4            5            6            7            8

Variable				A1	A2	A3		
Type				F	F	F		

Card 5            1            2            3            4            5            6            7            8

Variable	V1	V2	V3	D1	D2	D3	BETA	FIT
Type	F	F	F	F	F	F	F	I

<u>VARIABLE</u>	<u>DESCRIPTION</u>
MID	Material Identification number.
RO	Constant Mass density.
E	Young's modulus E.GT.0.0: constant value E.LT.0.0: load curve ID (-E) which defines the Young's modulus as a function of plastic strain.
PR	Poisson's ratio
HR	Hardening rules: HR.EQ.1.0: linear hardening (default) HR.EQ.2.0: exponential hardening (Swift) HR.EQ.3.0: load curve HR.EQ.4.0: exponential hardening (Voce) HR.EQ.5.0: exponential hardening (Gosh) HR.EQ.6.0: exponential hardening (Hockett-Sherby)
P1	Material parameter: HR.EQ.1.0: tangent modulus HR.EQ.2.0: q, coefficient for exponential hardening law (Swift) HR.EQ.4.0: a, coefficient for exponential hardening law (Voce) HR.EQ.5.0: q, coefficient for exponential hardening law (Gosh) HR.EQ.6.0: a, coefficient for exponential hardening law (Hockett-Sherby)
P2	Material parameter: HR.EQ.1.0: yield stress for the linear hardening law HR.EQ.2.0: n, coefficient for (Swift) exponential hardening HR.EQ.4.0: c, coefficient for exponential hardening law (Voce) HR.EQ.5.0: n, coefficient for exponential hardening law (Gosh) HR.EQ.6.0: c, coefficient for exponential hardening law (Hockett-Sherby)

VARIABLE	DESCRIPTION
ITER	Iteration flag for speed: ITER.EQ.0.0: fully iterative ITER.EQ.1.0: fixed at three iterations. Generally, ITER=0.0 is recommended. However, ITER=1.0 is faster and may give acceptable results in most problems.
A	Exponent in Cazacu-Barlat's orthotropic yield surface ( $A > 1$ )
C11	Material parameter (see card 5 pos. 8): FIT.EQ.1.0 or EQ.2.0: yield stress for tension in the 00 direction FIT.EQ.0.0: material parameter c11
C22	Material parameter (see card 5 pos.8): FIT.EQ.1.0 or EQ.2.0: yield stress for tension in the 45 direction FIT.EQ.0.0: material parameter c22
C33	Material parameter (see card 5 pos.8): FIT.EQ.1.0 or EQ.2.0: yield stress for tension in the 90 direction FIT.EQ.0.0: material parameter c33
LCID	Load curve ID for the hardening law (HR.EQ.3.0)
E0	Material parameter: HR.EQ.2.0: initial yield stress for exponential hardening law (Swift) (default =0.0) HR.EQ.4.0: b, coefficient for exponential hardening (Voce) HR.EQ.5.0: initial yield stress for exponential hardening (Gosh), Default=0.0 HR.EQ.6.0: b, coefficient for exponential hardening law (Hockett-Sherby)
K	Material parameter (see card 5 pos.8): FIT.EQ.1.0 or EQ.2.0: yield stress for compression in the 00 direction FIT.EQ.0.0: material parameter ( $-1 < k < 1$ )
P3	Material parameter: HR.EQ.5.0: p, coefficient for exponential hardening (Gosh) HR.EQ.6.0: n, exponent for exponential hardening law (Hockett-Sherby)

VARIABLE	DESCRIPTION
AOPT	<p>Material axes option (see MAT_OPTION TROPIC_ELASTIC for more complete description).</p> <p>AOPT.EQ.0.0 locally orthotropic with material axes determined by element nodes 1, 2 and 4, as with *DEFINE_COORDINATE_NODES, and then rotated about the shell element normal by the angle BETA.</p> <p>AOPT.EQ.2.0: globally orthotropic with material axes determined by vectors defined below, as with *DEFINED_COORDINATE_VECTOR.</p> <p>AOPT.EQ.3.0: locally orthotropic material axes determined by rotating the material axes about the element normal by an angle BETA, from a line in the plane of the element defined by the cross product of the vector V with the element normal.</p> <p>AOPT.LT.0.0: the absolute value of AOPT is coordinate system ID (CID on *DEFINE_COORDINATE_NODES, *DEFINE_COORDINATE_SYSTEM, or *DEFINE_COORDINATE_VECTOR). Available with the R3 release of 971 and later.</p>
C12	Material parameter. If parameter identification (FIT=1.0) is turned on C12 is not used.
C13	Material parameter. If parameter identification (FIT=1.0) is turned on C13=0.0
C23	Material parameter. If parameter identification (FIT=1.0) is turned on C23=0.0
C44	<p>Material parameter (see card 5 pos.8)</p> <p>FIT.EQ.1.0 or EQ.2.0: yield stress for the balanced biaxial tension test.</p> <p>FIT.EQ.0.0: material parameter c44</p>
A1-A3	Components of vector <b>a</b> for AOPT=2.0
V1-V3	Components of vector <b>v</b> for AOPT=3.0
D1-D3	Components of vector <b>d</b> for AOPT=2.0
BETA	Material angle in degrees for AOPT = 0 and 3. NOTE, may be overridden on the element card, see *ELEMENT_SHELL_BETA

VARIABLE	DESCRIPTION
FIT	<p>Flag for parameter identification algorithm:</p> <p>FIT.EQ.0.0: No parameter identification routine is used. The variables K, C11, C22, C33, C44, C12, C13 and C23 are interpreted as material parameters.</p> <p>FIT.EQ.1.0: Parameter fit is used. The variables C11, C22, C33, C44 and K are interpreted as yield stresses in the 00, 45, 90 degree directions, the balanced biaxial tension and the 00 degree compression, respectively. NOTE: it is recommended to always <u>check</u> the d3hsp file to see the fitted parameters before complex jobs are submitted.</p> <p>FIT.EQ.2.0: Same as EQ.1.0 but also produce contour plots of the yield surface. For each material three LS-PREPOST ready xy-data files are created; Contour1_x, Contour2_x and Contour3_x where x equal the material numbers.</p>

**Remarks:**

The material model #233 (MAT\_CAZACU\_BARLAT) is aimed for modeling materials with strength differential and orthotropic behavior under plane stress. The yield condition includes a parameter  $k$  that describes the asymmetry between yield in tension and compression. Moreover, to include the anisotropic behavior the stress deviator  $\mathbf{S}$  undergoes a linear transformation. The principal values of the Cauchy stress deviator are substituted with the principal values of the transformed tensor  $\mathbf{Z}$ , which is represented as a vector field, defined as:

$$\mathbf{Z} = \mathbf{C}\mathbf{S} \tag{233.1}$$

where  $\mathbf{S}$  is the field comprised of the four stresses deviator components  $S_I = (s_{11}, s_{22}, s_{33}, s_{12})$ ,

$$\mathbf{s} = \boldsymbol{\sigma} - \frac{1}{3} \text{tr}(\boldsymbol{\sigma}) \boldsymbol{\delta},$$

where  $\text{tr}(\boldsymbol{\sigma})$  is the trace of the Cauchy stress tensor and  $\boldsymbol{\delta}$  is the Kronecker delta. For the 2D plane stress condition, the orthotropic condition gives 7 independent coefficients. The tensor  $\mathbf{C}$  is represented by the 4x4 matrix

$$C_{IJ} = \begin{pmatrix} c_{11} & c_{12} & c_{13} & \\ c_{12} & c_{22} & c_{23} & \\ c_{13} & c_{23} & c_{33} & \\ & & & c_{44} \end{pmatrix}.$$

The principal values of  $\mathbf{Z}$  are denoted  $\Sigma_1, \Sigma_2, \Sigma_3$  and are given as the eigenvalues to the matrix composed by the components  $\Sigma_{xx}, \Sigma_{yy}, \Sigma_{zz}, \Sigma_{xy}$  through



$$\begin{aligned}\Sigma_1 &= \frac{1}{2} \left( \Sigma_{xx} + \Sigma_{yy} + \sqrt{(\Sigma_{xx} - \Sigma_{yy})^2 + 4\Sigma_{xy}^2} \right), \\ \Sigma_2 &= \frac{1}{2} \left( \Sigma_{xx} + \Sigma_{yy} - \sqrt{(\Sigma_{xx} - \Sigma_{yy})^2 + 4\Sigma_{xy}^2} \right), \\ \Sigma_3 &= \Sigma_{zz}\end{aligned}$$

where

$$\begin{aligned}3\Sigma_{xx} &= (2c_{11} - c_{12} - c_{13})\sigma_{xx} + (-c_{11} + 2c_{12} - c_{13})\sigma_{yy}, \\ 3\Sigma_{yy} &= (2c_{12} - c_{22} - c_{23})\sigma_{xx} + (-c_{12} + 2c_{22} - c_{23})\sigma_{yy}, \\ 3\Sigma_{zz} &= (2c_{13} - c_{23} - c_{33})\sigma_{xx} + (-c_{13} + 2c_{23} - c_{33})\sigma_{yy}, \\ \Sigma_{xy} &= c_{44}\sigma_{12}\end{aligned}$$

Note that the symmetry of  $\Sigma_{xy}$  follows from the symmetry of the Cauchy stress tensor.

The yield condition is written on the following form:

$$f(\mathbf{\Sigma}, k, \varepsilon_{ep}) = \sigma_{eff}(\Sigma_1, \Sigma_2, \Sigma_3, k) - \sigma_y(\varepsilon_{ep}) \leq 0 \quad (233.2)$$

where  $\sigma_y(\varepsilon_{ep})$  is a function representing the current yield stress dependent on current effective plastic strain and  $k$  is the asymmetric parameter for yield in compression and tension. The effective stress  $\sigma_{eff}$  is given by

$$\sigma_{eff} = \left( (|\Sigma_1| - k\Sigma_1)^a + (|\Sigma_2| - k\Sigma_2)^a + (|\Sigma_3| - k\Sigma_3)^a \right)^{1/a} \quad (233.3)$$

where  $k \in [-1, 1]$ ,  $a \geq 1$ . Now, let  $\sigma_{00}^T$  and  $\sigma_{00}^C$  represent the yield stress along the rolling (00 degree) direction in tension and compression, respectively. Furthermore let  $\sigma_{45}^T$  and  $\sigma_{90}^T$  represent the yield stresses in the 45 and the 90 degree directions, and last let  $\sigma_B^T$  be the balanced biaxial yield stress in tension. Following Cazacu et al. (2006) the yield stresses can easily be derived. To simplify the equations it is preferable to make the following definitions:

$$\begin{aligned}\Phi_1 &= \frac{1}{3}(2c_{11} - c_{12} - c_{13}) & \Psi_1 &= \frac{1}{3}(-c_{11} + 2c_{12} - c_{13}) \\ \Phi_2 &= \frac{1}{3}(2c_{12} - c_{22} - c_{23}) & \Psi_2 &= \frac{1}{3}(-c_{12} + 2c_{22} - c_{23}) \\ \Phi_3 &= \frac{1}{3}(2c_{13} - c_{23} - c_{33}) & \Psi_3 &= \frac{1}{3}(-c_{13} + 2c_{23} - c_{33})\end{aligned}$$

The yield stresses can now be written as

- In the 00 degree direction:

$$\sigma_{00}^T = \left( \frac{(\sigma_{eff})^a}{(|\Phi_1| - k\Phi_1)^a + (|\Phi_2| - k\Phi_2)^a + (|\Phi_3| - k\Phi_3)^a} \right)^{1/a}, \quad (233.4)$$

$$\sigma_{00}^C = \left( \frac{(\sigma_{eff})^a}{(|\Phi_1| + k\Phi_1)^a + (|\Phi_2| + k\Phi_2)^a + (|\Phi_3| + k\Phi_3)^a} \right)^{1/a}.$$

- In the 45 degree direction:

$$\sigma_{45}^T = \left( \frac{(\sigma_{eff})^a}{(|\Lambda_1| - k\Lambda_1)^a + (|\Lambda_2| - k\Lambda_2)^a + (|\Lambda_3| - k\Lambda_3)^a} \right)^{1/a} \quad (233.5)$$

where

$$\Lambda_1 = \frac{1}{4} \left[ \Phi_1 + \Phi_2 + \Psi_1 + \Psi_2 + \sqrt{(\Phi_1 + \Psi_1 - \Phi_2 - \Psi_2)^2 + 4c_{44}^2} \right],$$

$$\Lambda_2 = \frac{1}{4} \left[ \Phi_1 + \Phi_2 + \Psi_1 + \Psi_2 - \sqrt{(\Phi_1 + \Psi_1 - \Phi_2 - \Psi_2)^2 + 4c_{44}^2} \right],$$

$$\Lambda_3 = \frac{1}{2} [\Phi_3 + \Psi_3].$$

- In the 90 degree direction:

$$\sigma_{90}^T = \left( \frac{(\sigma_{eff})^a}{(|\Psi_1| - k\Psi_1)^a + (|\Psi_2| - k\Psi_2)^a + (|\Psi_3| - k\Psi_3)^a} \right)^{1/a} \quad (233.6)$$

- In the balanced biaxial yield occurs when both  $\sigma_{xx}$  and  $\sigma_{yy}$  are equal to:

$$\sigma_B^T = \left( \frac{(\sigma_{eff})^a}{(|\Omega_1| - k\Omega_1)^a + (|\Omega_2| - k\Omega_2)^a + (|\Omega_3| - k\Omega_3)^a} \right)^{1/a} \quad (233.7)$$

where

$$\Omega_1 = \frac{1}{3}(c_{11} + c_{12} - 2c_{13}), \Omega_2 = \frac{1}{3}(c_{12} + c_{22} - 2c_{23}), \Omega_3 = \frac{1}{3}(c_{13} + c_{23} - 2c_{33})$$

### Hardening laws

The implemented hardening laws are the following:

- The Swift hardening law
- The Voce hardening law

- The Gosh hardening law
- The Hocket-Sherby hardening law
- A loading curve, where the yield stress is given as a function of the effective plastic strain

The Swift's hardening law can be written

$$\sigma_y(\varepsilon_{ep}) = q(\varepsilon_0 + \varepsilon_{ep})^n$$

where  $q$  and  $n$  are material parameters.

The Voce's equation says that the yield stress can be written in the following form

$$\sigma_y(\varepsilon_{ep}) = a - be^{-c\varepsilon_{ep}}$$

where  $a$ ,  $b$  and  $c$  are material parameters. The Gosh's equation is similar to Swift's equation. They only differ by a constant

$$\sigma_y(\varepsilon_{ep}) = q(\varepsilon_0 + \varepsilon_{ep})^n - p$$

where  $q$ ,  $\varepsilon_0$ ,  $n$  and  $p$  are material constants. The Hocket-Sherby equation resemblance the Voce's equation, but with an additional parameter added

$$\sigma_y(\varepsilon_{ep}) = a - be^{-c\varepsilon_{ep}^n}$$

where  $a$ ,  $b$ ,  $c$  and  $n$  are material parameters.

### Constitutive relation and material stiffness

The classical elastic constitutive equation for linear deformations is the well-known Hooke's law. This relation written in a rate formulation is given by

$$\dot{\boldsymbol{\sigma}} = \mathbf{D}\dot{\boldsymbol{\varepsilon}}_e \quad (233.8)$$

where  $\boldsymbol{\varepsilon}_e$  is the elastic strain and  $\mathbf{D}$  is the constitutive matrix. An over imposed dot implies differentiation respect to time. Introducing the total strain  $\boldsymbol{\varepsilon}$  and the plastic strain  $\boldsymbol{\varepsilon}_p$ , Eq. (233.8) is classically rewritten as

$$\dot{\boldsymbol{\sigma}} = \mathbf{D}(\dot{\boldsymbol{\varepsilon}} - \dot{\boldsymbol{\varepsilon}}_p) \quad (233.9)$$

where

$$\mathbf{D} = \frac{E}{1-\nu^2} \begin{pmatrix} 1 & \nu & & & \\ \nu & 1 & & & \\ & & \frac{1-\nu}{2} & & \\ & & & \frac{1-\nu}{2} & \\ & & & & \frac{1-\nu}{2} \end{pmatrix} \text{ and } (\dot{\boldsymbol{\varepsilon}} - \dot{\boldsymbol{\varepsilon}}_p) = \begin{pmatrix} \dot{\varepsilon}_{11} - (\dot{\varepsilon}_p)_{11} \\ \dot{\varepsilon}_{22} - (\dot{\varepsilon}_p)_{22} \\ 2(\dot{\varepsilon}_{12} - (\dot{\varepsilon}_p)_{12}) \\ 2(\dot{\varepsilon}_{13} - (\dot{\varepsilon}_p)_{13}) \\ 2(\dot{\varepsilon}_{23} - (\dot{\varepsilon}_p)_{23}) \end{pmatrix}.$$

The parameters  $E$  and  $\nu$  are the Young's modulus and Poisson's ratio, respectively.

The material stiffness  $\mathbf{D}_p$  that is needed for e.g., implicit analysis can be calculated from (233.9) as

$$\mathbf{D}_p = \frac{\partial \dot{\boldsymbol{\sigma}}}{\partial \dot{\boldsymbol{\varepsilon}}}.$$

The associative flow rule for the plastic strain is usually written

$$\dot{\boldsymbol{\varepsilon}}_p = \dot{\lambda} \frac{\partial f}{\partial \boldsymbol{\sigma}} \quad (233.10)$$

and the consistency condition reads

$$\frac{df}{d\boldsymbol{\sigma}} \cdot \dot{\boldsymbol{\sigma}} + \frac{df}{d\varepsilon_{ep}} \dot{\varepsilon}_{ep} = 0. \quad (233.11)$$

Note that the centralized “dot” means scalar product between two vectors. Using standard calculus one easily derives from (1.9), (1.10) and (1.11) an expression for the stress rate

$$\dot{\boldsymbol{\sigma}} = \left( \mathbf{D} - \frac{\left( \mathbf{D} \frac{df}{d\boldsymbol{\sigma}} \right) \cdot \left( \mathbf{D} \frac{df}{d\boldsymbol{\sigma}} \right)}{\frac{df}{d\boldsymbol{\sigma}} \cdot \left( \mathbf{D} \frac{df}{d\boldsymbol{\sigma}} \right) - \frac{df}{d\varepsilon_{ep}}} \right) \dot{\boldsymbol{\varepsilon}}. \quad (233.12)$$

That means that the material stiffness used for implicit analysis is given by

$$\mathbf{D}_p = \mathbf{D} - \frac{\left( \mathbf{D} \frac{df}{d\boldsymbol{\sigma}} \right) \cdot \left( \mathbf{D} \frac{df}{d\boldsymbol{\sigma}} \right)}{\frac{df}{d\boldsymbol{\sigma}} \cdot \left( \mathbf{D} \frac{df}{d\boldsymbol{\sigma}} \right) - \frac{df}{d\varepsilon_{ep}}}.$$

To be able to do a stress update we need to calculate the tangent stiffness and the derivative with respect to the corresponding hardening law.

When a suitable hardening law has been chosen the corresponding derivative is simple and will be left out from this document. However, the stress gradient of the yield surface is more complicated and will be outlined here.

$$\begin{aligned} \frac{df}{d\sigma_{11}} = & \frac{1}{2} \frac{df}{d\Sigma_1} \left[ \left( 1 + \frac{\Sigma_{xx} - \Sigma_{yy}}{\sqrt{\Sigma_T}} \right) \Phi_1 + \left( 1 - \frac{\Sigma_{xx} - \Sigma_{yy}}{\sqrt{\Sigma_T}} \right) \Phi_2 \right] \\ & + \frac{1}{2} \frac{df}{d\Sigma_2} \left[ \left( 1 - \frac{\Sigma_{xx} - \Sigma_{yy}}{\sqrt{\Sigma_T}} \right) \Phi_1 + \left( 1 + \frac{\Sigma_{xx} - \Sigma_{yy}}{\sqrt{\Sigma_T}} \right) \Phi_2 \right] + \frac{df}{d\Sigma_3} \Phi_3 \end{aligned} \quad (233.13)$$

$$\begin{aligned} \frac{df}{d\sigma_{22}} = & \frac{1}{2} \frac{df}{d\Sigma_1} \left[ \left( 1 + \frac{\Sigma_{xx} - \Sigma_{yy}}{\sqrt{\Sigma_T}} \right) \Psi_1 + \left( 1 - \frac{\Sigma_{xx} - \Sigma_{yy}}{\sqrt{\Sigma_T}} \right) \Psi_2 \right] \\ & + \frac{1}{2} \frac{df}{d\Sigma_2} \left[ \left( 1 - \frac{\Sigma_{xx} - \Sigma_{yy}}{\sqrt{\Sigma_T}} \right) \Psi_1 + \left( 1 + \frac{\Sigma_{xx} - \Sigma_{yy}}{\sqrt{\Sigma_T}} \right) \Psi_2 \right] + \frac{df}{d\Sigma_3} \Psi_3 \end{aligned} \quad (233.14)$$

and the derivative with respect to the shear stress component is

$$\frac{df}{d\sigma_{12}} = c_{44} \frac{2\Sigma_{xy}}{\sqrt{\Sigma_T}} \left( \frac{df}{d\Sigma_1} - \frac{df}{d\Sigma_2} \right) \quad (233.15)$$

where

$$\Sigma_T = (\Sigma_{xx} - \Sigma_{yy})^2 + 4\Sigma_{xy}^2 \quad (233.16)$$

and

$$\frac{df}{d\Sigma_i} = f(\Sigma, k, \varepsilon_{ep})^{\frac{1}{a}-1} (|\Sigma_i| - k\Sigma_i)^{a-1} (\text{sgn}(\Sigma_i) - k) \quad \text{for } i=1,2,3. \quad (233.17)$$

### Implementation

Assume that the stress and strain is known at time  $t^n$ . A trial stress  $\tilde{\sigma}^{n+1}$  at time  $t^{n+1}$  is calculated by assuming a pure elastic deformation, i.e.,

$$\tilde{\sigma}^{n+1} = \sigma^n + \mathbf{D}(\varepsilon^{n+1} - \varepsilon^n). \quad (233.18)$$

Now, if  $f(\Sigma, k, \varepsilon_{ep}) \leq 0$  the deformation is pure elastic and the new stress and plastic strain are determined as

$$\begin{aligned} \sigma^{n+1} &= \tilde{\sigma}^{n+1} \\ \varepsilon_{ep}^{n+1} &= \varepsilon_{ep}^n \end{aligned} \quad (233.19)$$

and the thickness strain increment is given by

$$\Delta\varepsilon_{33} = \varepsilon_{33}^{n+1} - \varepsilon_{33}^n = -\frac{\nu}{1-\nu} (\Delta\varepsilon_{11} + \Delta\varepsilon_{22}) \quad (233.20)$$

If the deformation is not pure elastic the stress is not inside the yield surface and a plastic iterative procedure must take place.

1. Set  $m=0$ ,  $\sigma_{(0)}^{n+1} = \tilde{\sigma}^{n+1}$ ,  $\varepsilon_{ep(0)}^{n+1} = \varepsilon_{ep}^n$  and  $\Delta\varepsilon_{11}^{p(0)} = \Delta\varepsilon_{22}^{p(0)} = 0$
2. Determine the plastic multiplier as

$$\Delta\lambda = \frac{f(\sigma_{(m)}^{n+1}, \varepsilon_{ep(m)}^{n+1})}{\frac{df}{d\sigma}(\sigma_{(m)}^{n+1}) \cdot \mathbf{D} \frac{df}{d\sigma}(\sigma_{(m)}^{n+1}) - \frac{df}{d\varepsilon_{ep}}(\varepsilon_{ep(m)}^{n+1})} \quad (233.21)$$

3. Perform a plastic corrector step:  $\sigma_{(m+1)}^{n+1} = \sigma_{(m)}^{n+1} - \Delta\lambda \mathbf{D} \frac{df}{d\sigma}(\sigma_{(m)}^{n+1})$  and find the increments in plastic strain according to

$$\begin{aligned} \varepsilon_{ep(m+1)}^{n+1} &= \varepsilon_{ep(m)}^{n+1} + \Delta\lambda \\ \Delta\varepsilon_{11}^{p(n+1)} &= \Delta\varepsilon_{11}^{p(n)} + \Delta\lambda \frac{df}{d\sigma_{11}}(\sigma_{(m)}^{n+1}) \\ \Delta\varepsilon_{22}^{p(n+1)} &= \Delta\varepsilon_{22}^{p(n)} + \Delta\lambda \frac{df}{d\sigma_{22}}(\sigma_{(m)}^{n+1}) \end{aligned} \quad (233.22)$$

4. If  $\left|f\left(\boldsymbol{\sigma}_{(m+1)}^{n+1}, \boldsymbol{\varepsilon}_{ep}^n\right)\right| < tol$  or  $m = m_{\max}$ ; stop and set

$$\begin{aligned} \boldsymbol{\sigma}^{n+1} &= \boldsymbol{\sigma}_{(m+1)}^{n+1}, \boldsymbol{\varepsilon}_{ep}^{n+1} = \boldsymbol{\varepsilon}_{ep(m+1)}^{n+1}, \\ \Delta \boldsymbol{\varepsilon}_{11}^p &= \Delta \boldsymbol{\varepsilon}_{11}^{p(m+1)}, \Delta \boldsymbol{\varepsilon}_{22}^p = \Delta \boldsymbol{\varepsilon}_{22}^{p(m+1)}, \end{aligned} \tag{233.23}$$

otherwise set  $m = m + 1$  and return to 2.

The thickness strain increment is for plastic yield calculated as

$$\Delta \boldsymbol{\varepsilon}_{33} = -\frac{1}{1-\nu}(\Delta \boldsymbol{\varepsilon}_{11} + \Delta \boldsymbol{\varepsilon}_{22}) - \left(1 - \frac{\nu}{1-\nu}\right)(\Delta \boldsymbol{\varepsilon}_{11}^p + \Delta \boldsymbol{\varepsilon}_{22}^p) \tag{233.24}$$

\*MAT\_VISCOELASTIC\_LOOSE\_FABRIC

This is Material Type 234 developed by Ivanov and Tabiei [2004]. The model is a mechanism incorporating the crimping of the fibers as well as the trellising with reorientation of the yarns and the locking phenomenon observed in loose fabric. The equilibrium of the mechanism allows the straightening of the fibers depending on the fiber tension. The contact force at the fiber cross over point determines the rotational friction dissipating a part of the impact energy. The stress-strain relationship is viscoelastic based on a three-element model. The failure of the fibers is strain rate dependent. \*DAMPING\_MASS is recommended to be used in conjunction with this material model. This material is valid for modeling the elastic and viscoelastic response of loose fabric used in body armor, blade containments, and airbags.

Card 1            1            2            3            4            5            6            7            8

Variable	MID	RO	E1	E2	G12	EU	THL	THI
Type	A8	F	F	F	F	F	F	F

Card 2            1            2            3            4            5            6            7            8

Variable	TA	W	s	T	H	S	EKA	EUA
Type	F	F	F	F	F	F	F	F

Card 3            1            2            3            4            5            6            7            8

Variable	VMB	C	G23	EKB	AOPT			
Type	F	F	F	F	F			

Card 4            1            2            3            4            5            6            7            8

Variable	Not used	Not used	Not used	A1	A2	A3		
Type				F	F	F		

Card 5            1            2            3            4            5            6            7            8

Variable	V1	V2	V3	D1	D2	D3		
Type	F	F	F	F	F	F		

<u>VARIABLE</u>	<u>DESCRIPTION</u>
MID	Material identification. A unique number or label not exceeding 8 characters must be specified.
RO	Mass density.
E1	$E_1$ , Young's modulus in the yarn axial-direction.
E2	$E_2$ , Young's modulus in the yarn transverse-direction.
G12	$G_{12}$ , Shear modulus of the yarns.
EU	Ultimate strain at failure.
THL	Yarn locking angle.
THI	Initial brade angle.
TA	Transition angle to locking.
W	Fiber width.
S	Span between the fibers.
T	Real fiber thickness.
H	Effective fiber thickness.
S	Fiber cross-sectional area.
EKA	Elastic constant of element "a".
EUA	Ultimate strain of element "a".
VMB	Damping coefficient of element "b".
C	Coefficient of friction between the fibers.
G23	transverse shear modulus.



VARIABLE	DESCRIPTION
Ekb	Elastic constant of element "b"
AOPT	<p>Material axes option (see MAT_OPTION TROPIC_ELASTIC for more complete description).</p> <p>AOPT.EQ.0.0 locally orthotropic with material axes determined by element nodes 1, 2 and 4, as with *DEFINE_COORDINATE_NODES.</p> <p>AOPT.EQ.2.0: globally orthotropic with material axes determined by vectors defined below, as with *DEFINED_COORDINATE_VECTOR.</p> <p>AOPT.EQ.3.0: locally orthotropic material axes defined by the cross product of the vector V with the element normal.</p> <p>AOPT.LT.0.0: the absolute value of AOPT is coordinate system ID (CID on *DEFINE_COORDINATE_NODES, *DEFINE_COORDINATE_SYSTEM, or *DEFINE_COORDINATE_VECTOR). Available with the R3 release of 971 and later.</p>

### **Remarks:**

The parameters of the Representative Volume Cell (RVC) are: the yarn span,  $s$ , the fabric thickness,  $t$ , the yarn width,  $w$ , and the yarn cross-sectional area,  $A$ . The initially orthogonal yarns (see Fig. 2a) are free to rotate (see Fig. 2b) up to some angle and after that the lateral contact between the yarns causes the locking of the trellis mechanism and the packing of the yarns (see Fig. 2c). The minimum braid angle,  $\theta_{\min}$ , can be calculated from the geometry and the architecture of the fabric material having the yarn width,  $w$ , and the span between the yarns,  $s$ :

$$\sin(2\theta_{\min}) = \frac{w}{s}$$

The other constrain angles as the locking range angle,  $\theta_{lock}$ , and the maximum braid angle,  $\theta_{\max}$ , (see Fig) are easy to be determined then:

$$\theta_{lock} = 45^\circ - \theta_{\min}, \quad \theta_{\max} = 45^\circ + \theta_{lock}$$

The material behavior of the yarn can be simply described by a combination of one Maxwell element without the dashpot and one Kelvin-Voigt element. The 1-D model of viscoelasticity is shown in the following figure. The differential equation of viscoelasticity of the yarns can be derived from the model equilibrium as in the following equation:

$$(K_a + K_b)\sigma + \mu_b \dot{\sigma} = K_a K_b \varepsilon + \mu_b K_a \dot{\varepsilon}$$

The input parameters for the viscoelasticity model of the material are only the static Young's modulus  $E_1$ , the Hookian spring coefficient (EKA)  $K_a$ , the viscosity coefficient (VMB)  $\mu_b$ , the

static ultimate strain (EU)  $\varepsilon_{\max}$ , and the Hookian spring ultimate strain (EUA)  $\varepsilon_{a\max}$ . The other parameters can be obtained as follows:

$$K_b = \frac{K_a E_1}{K_a - E_1}$$

$$\varepsilon_{b\max} = \frac{K_a - E_1}{K_a} \varepsilon_{\max}$$

Applying the Eq. (18) for the fill and the warp yarns, we obtain the stress increments in the yarns,  $\Delta\sigma_f$  and  $\Delta\sigma_w$ . The stress in the yarns is updated for the next time step:

$$\sigma_f^{(n+1)} = \sigma_f^{(n)} + \Delta\sigma_f^{(n)}, \quad \sigma_w^{(n+1)} = \sigma_w^{(n)} + \Delta\sigma_w^{(n)} \quad (38)$$

We can imagine that the RVC is smeared to the parallelepiped in order to transform the stress acting on the yarn cross-section to the stress acting on the element wall. The thickness of the membrane shell element used should be equal to the effective thickness,  $t_e$ , that can be found by dividing the areal density of the fabric by its mass density. The in-plane stress components acting on the RVC walls in the material direction of the yarns are calculated as follows for the fill and warp directions:

$$\sigma_{f11}^{(n+1)} = \frac{2\sigma_f^{(n+1)} S}{s t_e}, \quad \sigma_{w11}^{(n+1)} = \frac{2\sigma_w^{(n+1)} S}{s t_e}$$

$$\sigma_{f22}^{(n+1)} = \sigma_{f22}^{(n)} + \alpha E_2 \Delta\varepsilon_{f22}^{(n)}, \quad \sigma_{w22}^{(n+1)} = \sigma_{w22}^{(n)} + \alpha E_2 \Delta\varepsilon_{w22}^{(n)}$$

$$\sigma_{f12}^{(n+1)} = \sigma_{f12}^{(n)} + \alpha G_{12} \Delta\varepsilon_{f12}^{(n)}, \quad \sigma_{w12}^{(n+1)} = \sigma_{w12}^{(n)} + \alpha G_{12} \Delta\varepsilon_{w12}^{(n)}$$

where  $E_2$  is the transverse Young's modulus of the yarns,  $G_{12}$  is the longitudinal shear modulus, and  $\alpha$  is the lateral contact factor. The lateral contact factor is zero when the trellis mechanism is open and unity if the mechanism is locked with full lateral contact between the yarns. There is a transition range,  $\Delta\theta$  (TA), of the average braid angle  $\theta$  in which the lateral contact factor,  $\alpha$ , is a linear function of the average braid angle. The graph of the function  $\alpha(\theta)$  is shown in Fig. 4.

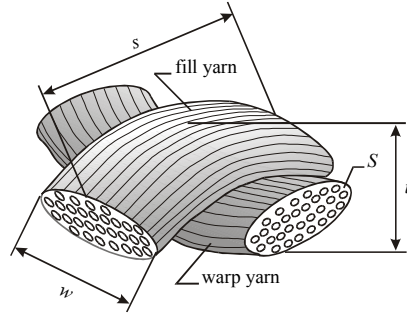

Fig. 1. Representative Volume Cell (RVC) of the model

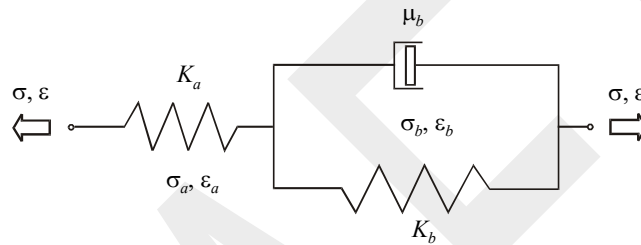

Fig. 2. Three-element viscoelasticity model

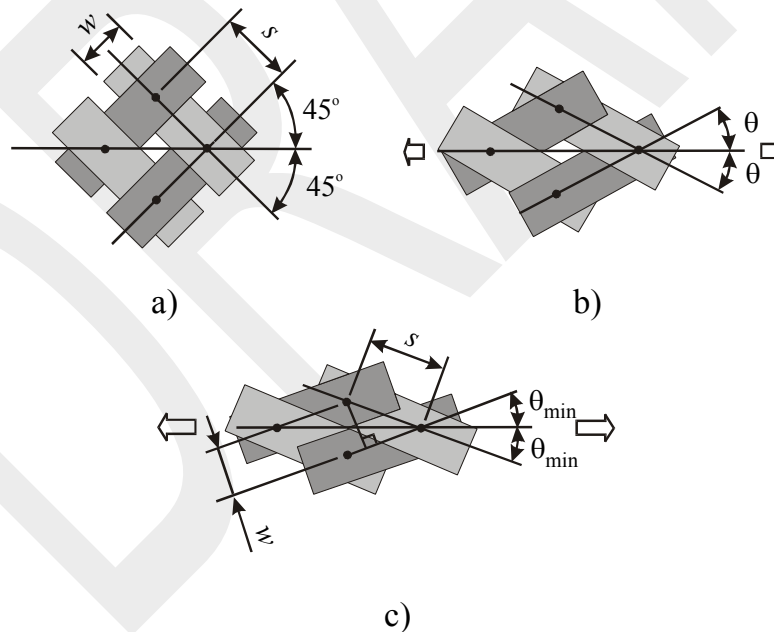

Fig. 3. Plain woven fabric as trellis mechanism: a) initial state; b) slightly stretched in bias direction; c) stretched to locking.

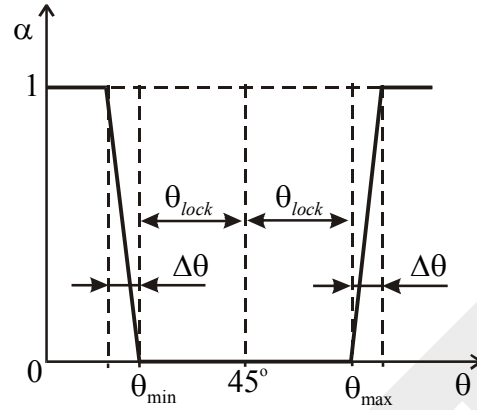

Fig. 4. The lateral contact factor as a function of average braid angle  $\theta$ .

\*MAT\_MICROMECHANICS\_DRY\_FABRIC

This is Material Type 235 developed by Tabiei and Ivanov [2001]. The material model derivation utilizes the micro-mechanical approach and the homogenization technique usually used in composite material models. The model accounts for reorientation of the yarns and the fabric architecture. The behavior of the flexible fabric material is achieved by discounting the shear moduli of the material in free state, which allows the simulation of the trellis mechanism before packing the yarns. This material is valid for modeling the elastic response of loose fabric used in inflatable structures, parachutes, body armor, blade containments, and airbags.

Card 1            1            2            3            4            5            6            7            8

Variable	MID	RO	E1	E2	G12	G23	V12	V23
Type	A8	F	F	F	F	F	F	F

Card 2            1            2            3            4            5            6            7            8

Variable	XT	THI	THL	BFI	BWI	DSCF	CNST	ATLR
Type	F	F	F	F	F	F	F	F

Card 3            1            2            3            4            5            6            7            8

Variable	VMB	VME	TRS	FFLG	AOPT			
Type	F	F	F	F	F			

Card 4            1            2            3            4            5            6            7            8

Variable	Not used	Not used	Not used	A1	A2	A3		
Type				F	F	F		

Card 5            1            2            3            4            5            6            7            8

Variable	V1	V2	V3	D1	D2	D3		
Type	F	F	F	F	F	F		

<u>VARIABLE</u>	<u>DESCRIPTION</u>
MID	Material identification. A unique number or label not exceeding 8 characters must be specified.
RO	Mass density.
E1	$E_1$ , Young's modulus of the yarn in axial-direction.
E2	$E_2$ , Young's modulus of the yarn in transverse-direction.
G12	$G_{12}$ , shear modulus of the yarns.
G23	$G_{23}$ , transverse shear modulus of the yarns.
V12	Poisson's ratio.
V23	Transverse Poisson's ratio.
XT	Stress or strain to failure (see FFLG).
THI	Initial brade angle.
THL	Yarn locking angle.
BFI	Initial undulation angle in fill direction.
BWI	Initial undulation angle in warp direction.
DSCF	Discount factor
CNST	Reorientation damping constant
ATLR	Angle tolerance for locking
VME	Viscous modulus for normal strain rate
VMS	Viscous modulus for shear strain rate
TRS	Transverse shear modulus of the fabric layer

VARIABLE	DESCRIPTION
FFLG	Flag for stress-based or strain-based failure EQ.0: XT is a stress to failure NE.0: XT is a strain to failure
AOPT	Material axes option (see MAT_OPTION TROPIC_ELASTIC for more complete description). AOPT.EQ.0.0 locally orthotropic with material axes determined by element nodes 1, 2 and 4, as with *DEFINE_COORDINATE_NODES. AOPT.EQ.2.0: globally orthotropic with material axes determined by vectors defined below, as with *DEFINED_COORDINATE_VECTOR. AOPT.EQ.3.0: locally orthotropic material axes defined by the cross product of the vector V with the element normal. AOPT.LT.0.0: the absolute value of AOPT is coordinate system ID (CID on *DEFINE_COORDINATE_NODES, *DEFINE_COORDINATE_SYSTEM, or *DEFINE_COORDINATE_VECTOR). Available with the R3 release of 971 and later.
A1-A3	Components of vector <b>a</b> for AOPT=2.0
V1-V3	Components of vector <b>v</b> for AOPT=3.0
D1-D3	Components of vector <b>d</b> for AOPT=2.0

**Remarks:**

The Representative Volume Cell (RVC) approach is utilized in the micro-mechanical model development. The direction of the yarn in each sub-cell is determined by two angles – the braid angle,  $\theta$  (*the initial braid angle is 45 degrees*), and the undulation angle of the yarn, which is different for the fill and warp-yarns,  $\beta_f$  and  $\beta_w$  (the initial undulations are normal few degrees), respectively. The starting point for the homogenization of the material properties is the determination of the yarn stiffness matrices.

$$[C'] = [S']^{-1} = \begin{bmatrix} \frac{1}{E_1} & -\frac{\nu_{12}}{E_1} & -\frac{\nu_{12}}{E_1} & 0 & 0 & 0 \\ -\frac{\nu_{12}}{E_1} & \frac{1}{E_2} & -\frac{\nu_{23}}{E_2} & 0 & 0 & 0 \\ -\frac{\nu_{12}}{E_1} & -\frac{\nu_{23}}{E_2} & \frac{1}{E_2} & 0 & 0 & 0 \\ 0 & 0 & 0 & \frac{1}{\mu G_{12}} & 0 & 0 \\ 0 & 0 & 0 & 0 & \frac{1}{\mu G_{23}} & 0 \\ 0 & 0 & 0 & 0 & 0 & \frac{1}{\mu G_{12}} \end{bmatrix}^{-1}$$

where  $E_1, E_2, \nu_{12}, \nu_{23}, G_{12}$  and  $G_{23}$  are Young's moduli, Poisson's ratios, and the shear moduli of the yarn material, respectively.  $\mu$  is a discount factor, which is function of the braid angle,  $\theta$ , and has value between  $\mu_0$  and 1 as shown in the next figure. Initially, in free stress state, the discount factor is a small value ( $DSCF = \mu_0 \ll 1$ ) and the material has very small resistance to shear deformation if any. When the locking occurs, the fabric yarns are packed and they behave like elastic media. The discount factor is unity as shown in the next figure. The micro-mechanical model is developed to account for the reorientation of the yarns up to the locking angle. The locking angle,  $\theta_{lock}$ , can be obtained from the yarn width and the spacing parameter of the fabric using simple geometrical relationship. The transition range,  $\Delta\theta$  (angle tolerance for locking), can be chosen to be as small as possible, but big enough to prevent high frequency oscillations in transition to compacted state and depends on the range to the locking angle and the dynamics of the simulated problem. Reorientation damping constant is defined to damp some of the high frequency oscillations. A simple rate effect is added by defining the viscous modulus for normal or shear strain rate ( $VMB * \dot{\mathcal{E}}_{11 \text{ or } 22}$  for normal components and  $VMS * \dot{\mathcal{E}}_{12}$  for the shear components).



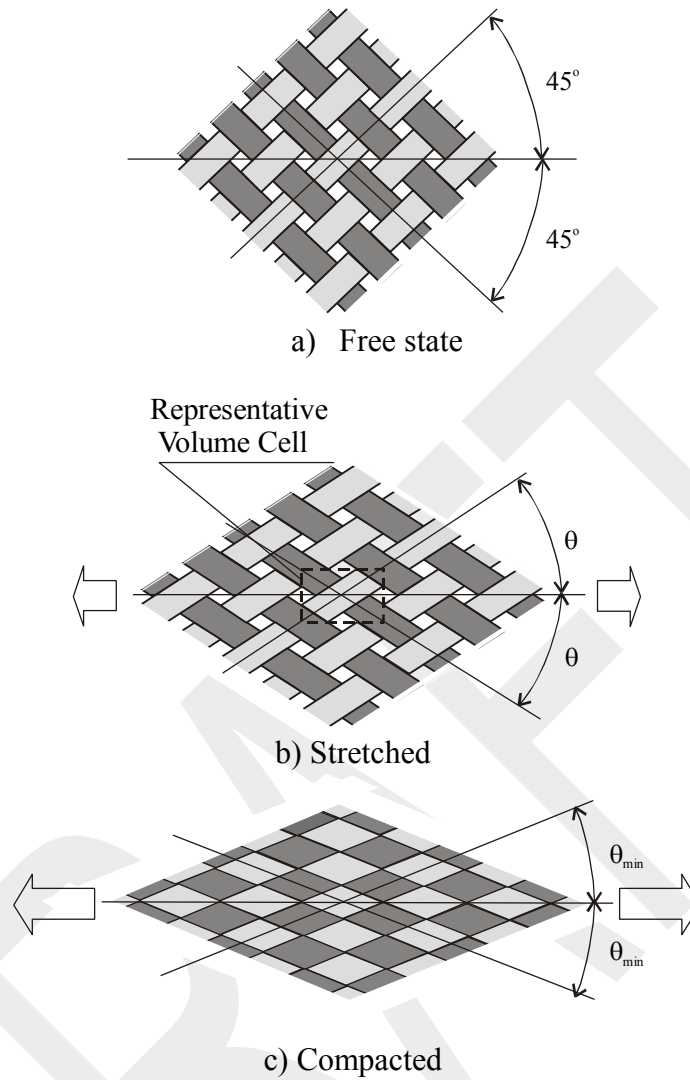

**Fig. 1. Plain-woven fabric interlacing pattern.**

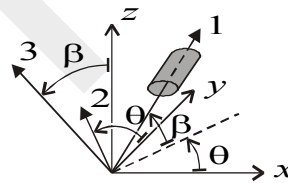

**Fig. 2. Yarn orientation.**

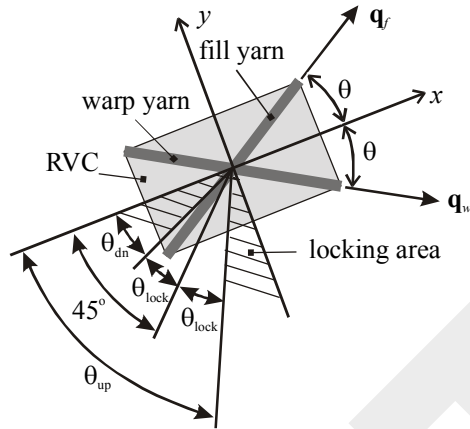

Fig. 3. Locking angles.

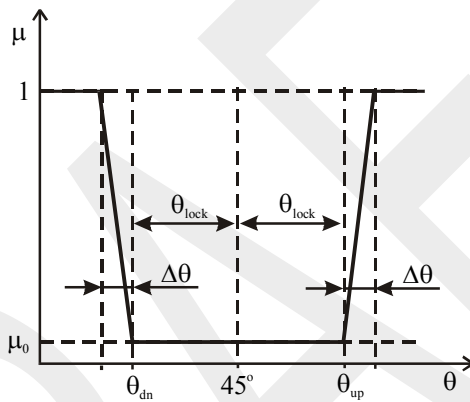

Fig. 4. Discount factor as a function of braid angle,  $\theta$ .

\*MAT\_SCC\_ON\_RCC

This is Material Type 236 developed by Carney, Lee, Goldberg, and Santhanam [2007]. This model simulates silicon carbide coating on Reinforced Carbon-Carbon (RCC), a ceramic matrix and is based upon a quasi-orthotropic, linear-elastic, plane-stress model. Additional constitutive model attributes include a simple (i.e. non-damage model based) option that can model the tension crack requirement: a “stress-cutoff” in tension. This option satisfies the tension crack requirements by limiting the stress in tension but not compression, and having the tensile “yielding” (i.e. the stress-cutoff) be fully recoverable – not plasticity or damage based.

Card 1            1            2            3            4            5            6            7            8

Variable	MID	RO	E0	E1	E2	E3	E4	E5
Type	A8	F	F	F	F	F	F	F

Card 2            1            2            3            4            5            6            7            8

Variable	PR	G	G_SCL	TSL	EPS_TAN			
Type	F	F	F	F	F			

<u>VARIABLE</u>	<u>DESCRIPTION</u>
MID	Material identification. A unique number or label not exceeding 8 characters must be specified.
RO	Mass density.
E0	E <sub>0</sub> , See Remarks below.
E1	E <sub>1</sub> , See Remarks below.
E2	E <sub>2</sub> , See Remarks below.
E3	E <sub>3</sub> , See Remarks below.
E4	E <sub>4</sub> , See Remarks below.
E5	E <sub>5</sub> , Young’s modulus of the yarn in transverse-direction.
PR	Poisson’s ratio.

VARIABLE	DESCRIPTION
G	Shear modulus
G_SCL	Shear modulus multiplier (default=1.0).
TSL	Tensile limit stress
EPS_TAN	Strain at which E=tangent to the polynomial curve.

**Remarks:**

This model for the silicon carbide coating on RCC is based upon a quasi-orthotropic, linear-elastic, plane-stress model, given by:

$$\begin{Bmatrix} \sigma_1 \\ \sigma_2 \\ \tau_{12} \end{Bmatrix} = \begin{bmatrix} \frac{E}{1-\nu^2} & \frac{\nu E}{1-\nu^2} & 0 \\ \frac{\nu E}{1-\nu^2} & \frac{E}{1-\nu^2} & 0 \\ 0 & 0 & G_{12} \end{bmatrix} \begin{Bmatrix} \epsilon_1 \\ \epsilon_2 \\ \gamma_{12} \end{Bmatrix}$$

Additional constitutive model requirements include a simple (i.e. non-damage model based) option that can model the tension crack requirement: a “stress-cutoff” in tension. This option satisfies the tension crack requirements by limiting the stress in tension but not compression, and having the tensile “yielding” (i.e. the stress-cutoff) be fully recoverable – not plasticity or damage based.

The tension stress-cutoff separately resets the stress to a limit value when it is exceeded in each of the two principal directions. There is also a strain-based memory criterion that ensures unloading follows the same path as loading: the “memory criterion” is the tension stress assuming that no stress cutoffs were in effect. In this way, when the memory criterion exceeds the user-specified cutoff stress, the actual stress will be set to that value. When the element unloads and the memory criterion falls back below the stress cutoff, normal behavior resumes. Using this criterion is a simple way to ensure that unloading does not result in any hysteresis. The cutoff criterion cannot be based on an effective stress value because effective stress does not discriminate between tension and compression, and also includes shear. This means that the in plane, 1- and 2- directions must be modeled as independent to use the stress cutoff. Because the Poisson’s ratio is not zero, this assumption is not true for cracks that may arbitrarily lie along any direction. However, careful examination of damaged RCC shows that generally, the surface cracks do tend to lie in the fabric directions as seen in Figure 3.2, meaning that cracks tend to open in the 1- or the 2- direction independently. So the assumption of directional independence for tension cracks may be appropriate for the coating because of this observed orthotropy.

The quasi-orthotropic, linear-elastic, plane-stress model with tension stress cutoff (to simulate tension cracks) can model the as-fabricated coating properties, which do not show nonlinearities, but not the non-linear response of the flight-degraded material. Explicit finite element analysis

(FEA) lends itself to *nonlinear-elastic* stress-strain relationship instead of linear-elastic. Thus, instead of  $\underline{\sigma} = \mathbf{E} \cdot \underline{\varepsilon}$ , the modulus will be defined as a function of some effective strain quantity, or  $\underline{\sigma} = \mathbf{E}(\varepsilon_{eff}) \cdot \underline{\varepsilon}$ , even though it is uncertain, from the available data, whether or not the coating response is completely nonlinear-elastic, and does not include some damage mechanism.

This nonlinear-elastic model cannot be implemented into a closed form solution or into an implicit solver; however, for explicit FEA such as is used for LS-DYNA impact analysis, the modulus can be adjusted at each time step to a higher or lower value as desired. In order to model the desired S-shape response curve of flight-degraded RCC coating, a function of strain that replicates the desired response must be found. It is assumed that the nonlinearities in the material are recoverable (elastic) and that the modulus is communicative between the 1- and 2- directions (going against the tension-crack assumption that the two directions do not interact). Sometimes stability can be a problem for this type of nonlinearity modeling, however, stability was not found to be a problem with the material constants used for the coating.

The von Mises strain is selected for the effective strain definition as it couples the 3-dimensional loading but reduces to uniaxial data, so that the desired uniaxial compressive response can be reproduced. So,

$$\varepsilon_{eff} = \frac{1}{\sqrt{2}} \frac{1}{1+\nu} \sqrt{(\varepsilon_1 - \varepsilon_2)^2 + (\varepsilon_2 - \varepsilon_3)^2 + (\varepsilon_1 - \varepsilon_3)^2 + 3\gamma_{12}^2}$$

where for a 2-D, isotropic shell element case, the z-direction strain is given by:

$$\varepsilon_3 = \frac{-\nu}{1-\nu} (\varepsilon_1 + \varepsilon_2)$$

The function for modulus is implemented as an arbitrary 5<sup>th</sup> order polynomial:

$$E(\varepsilon_{eff}) = A_0 \cdot \varepsilon_{eff}^0 + A_1 \cdot \varepsilon_{eff}^1 + \dots + A_5 \cdot \varepsilon_{eff}^5$$

In the case of as-fabricated material the first coefficient ( $A_0$ ) is simply the modulus E, and the other coefficients ( $A_{n>0}$ ) are zero, reducing to a 0<sup>th</sup> order polynomial, or linear. To match the degraded stress-strain compression curve, a higher order polynomial is needed. Six conditions on stress were used (stress and its derivative at beginning, middle, and end of the curve) to obtain a 5<sup>th</sup> order polynomial, and then the derivative of that equation was taken to obtain modulus as a function of strain, yielding a 4<sup>th</sup> order polynomial that represents the degraded coating modulus vs. strain curve.

For values of strain which exceed the failure strain observed in the laminate compression tests, the higher order polynomial will no longer match the test data. Therefore, after a specified effective-strain, representing failure, the modulus is defined to be the tangent of the polynomial curve. As a result, the stress/strain response has a continuous derivative, which aids in avoiding numerical instabilities. The test data does not clearly define the failure strain of the coating, but in the impact test it appears that the coating has a higher compressive failure strain in bending than the laminate failure strain.

The two dominant modes of loading which cause coating loss on the impact side of the RCC (the front-side) are in-plane compression and transverse shear. The in-plane compression is measured by the peak out of plane tensile strain,  $\epsilon_3$ . As there is no direct loading of a shell element in this direction,  $\epsilon_3$  is computed through Poisson's relation  $\epsilon_3 = \frac{-\nu}{1-\nu}(\epsilon_1 + \epsilon_2)$ . When  $\epsilon_3$  is tensile, it implies that the average of  $\epsilon_1$  and  $\epsilon_2$  is compressive. This failure mode will likely dominate when the RCC undergoes large bending, putting the front-side coating in high compressive strains. It is expected that a transverse shear failure mode will dominate when the debris source is very hard or very fast. By definition, the shell element cannot give a precise account of the transverse shear throughout the RCC's thickness. However, the Belytschko-Tsay shell element formulation in LS-DYNA has a first-order approximation of transverse shear that is based on the out-of-plane nodal displacements and rotations that should suffice to give a qualitative evaluation of the transverse shear. By this formulation, the transverse shear is constant through the entire shell thickness and thus violates surface-traction conditions. The constitutive model implementation records the peak value of the tensile out-of-plane strain ( $\epsilon_3$ ) and peak root-mean-sum transverse-shear:  $\sqrt{\epsilon_{13}^2 + \epsilon_{23}^2}$ .

\*MAT\_PML\_HYSTERETIC

This is Material Type 237. This is a perfectly-matched layer (PML) material with a Biot linear hysteretic constitutive law, to be used in a wave-absorbing layer adjacent to a Biot hysteretic material (\*MAT\_BIOT\_HYSTERETIC) in order to simulate wave propagation in an unbounded medium with material damping. This material is the visco-elastic counterpart of the elastic PML material (\*MAT\_PML\_ELASTIC). See the Remarks sections of \*MAT\_PML\_ELASTIC (\*MAT\_230) and \*MAT\_BIOT\_HYSTERETIC (\*MAT\_232) for further details.

Card            1            2            3            4            5            6            7            8

Variable	MID	RO	E	PR	ZT	FD		
Type	A8	F	F	F	F	F		
Default	none	none	none	none	0.0	3.25		

<u>VARIABLE</u>	<u>DESCRIPTION</u>
MID	Material identification. A unique number or label not exceeding 8 characters must be specified.
RO	Mass density.
E	Young's modulus.
PR	Poisson's ratio.
ZT	Damping ratio
FD	Dominant excitation frequency in Hz

**\*MAT\_PERT\_PIECEWISE\_LINEAR\_PLASTICITY**

This is Material Type 238. It is a duplicate of Material Type 24 (\*MAT\_PIECEWISE\_LINEAR\_PLASTICITY) modified for use with \*PERTURBATION\_MATERIAL and solid elements in an explicit analysis. It should give exactly the same values as the original material, if used exactly the same. It exists as a separate material type because of the speed penalty (an approximately 10% increase in the overall execution time) associated with the use of a material perturbation.

See Material Type 24 (\*MAT\_PIECEWISE\_LINEAR\_PLASTICITY) for a description of the material parameters. All of the documentation for Material Type 24 applies. Recommend practice is to first create the input deck using Material Type 24. Additionally, the CMP variable in the \*PERTURBATION\_MATERIAL must be set to affect a specific variables in the MAT\_238 definition as defined in the following table; for example, CMP=5 will perturb the yield stress.

**\*PERTURBATION\_MATERIAL      Material variable**

**CMP value**

3	E
5	SIGY
6	ETAN
7	FAIL



**\*MAT\_COHESIVE\_MIXED\_MODE\_ELASTOPLASTIC\_RATE**

This is Material Type 240. This model is a rate-dependent, elastic-ideally plastic cohesive zone model. It includes a tri-linear traction-separation law with a quadratic yield and damage initiation criterion in mixed-mode loading, while the damage evolution is governed by a power-law formulation. It can be used with solid element types 19 and 20, and is not available for other solid element formulations. See the remarks after \*SECTION\_SOLID for a description of element types 19 and 20.

Card 1            1            2            3            4            5            6            7            8

Variable	MID	RO	ROFLG	INTFAIL	EMOD	GMOD	THICK	OUTPUT
Type	A8	F	F	F	F	F	F	F

Card 2            1            2            3            4            5            6            7            8

Variable	G1C_0	G1C_INF	EDOT_G1	T0	T1	EDOT_T	FG1	
Type	F	F	F	F	F	F	F	

Card 3            1            2            3            4            5            6            7            8

Variable	G2C_0	G2C_INF	EDOT_G2	S0	S1	EDOT_S	FG2	
Type	F	F	F	F	F	F	F	

<u>VARIABLE</u>	<u>DESCRIPTION</u>
MID	Material identification. A unique number or label not exceeding 8 characters must be specified.
RO	Mass density
ROFLG	Flag for whether density is specified per unit area or volume. ROFLG=0 specified density per unit volume (default), and ROFLG=1 specifies the density is per unit area for controlling the mass of cohesive elements with an initial volume of zero.

<b>VARIABLE</b>	<b>DESCRIPTION</b>
EMOD	The Young's modulus of the material
GMOD	The shear modulus of the material
THICK	GT.0.0: Cohesive thickness LE.0.0: Initial thickness is calculated from nodal coordinates
OUTPUT	Time interval at which output is written into FORT.11-File
G1C_0	GT 0.0: Energy release rate $G_{IC}$ in Mode I LE. 0.0: Lower bound value of rate-dependent $G_{IC}$
G1C_INF	Upper bound value of rate-dependent $G_{IC}$ (only considered if $G1C\_0 < 0$ )
EDOT_G1	Equivalent strain rate at yield initiation to describe the rate dependency of $G_{IC}$ (only considered if $G1C\_0 < 0$ )
T0	GT.0.0: Yield stress in Mode I LT.0.0: Rate-dependency is considered, Parameter T0
T1	Parameter T1, only considered if $T0 < 0$ : GT.0.0: Quadratic logarithmic model LT.0.0: Linear logarithmic model
EDOT_T	Equivalent strain rate at yield initiation to describe the rate dependency of the yield stress in Mode I (only considered if $T0 < 0$ )
FG1	Parameter $f_{G1}$ to describe the tri-linear shape of the traction-separation law in Mode I
G2C_0	GT.0.0: Energy release rate $G_{IIC}$ in Mode II LE.0.0: Lower bound value of rate-dependent $G_{IIC}$
G2C_INF	Upper bound value of $G_{IIC}$ (only considered if $G2C\_0 < 0$ )
EDOT_G2	Equivalent strain rate at yield initiation to describe the rate dependency of $G_{IIC}$ (only considered if $G2C\_0 < 0$ )
S0	GT.0.0: Yield stress in Mode II LT.0.0: Rate-dependency is considered, Parameter S0
S1	Parameter S1, only considered if $S0 < 0$ : GT.0.0: Quadratic logarithmic model is applied LT.0.0: Linear logarithmic model is applied
EDOT_S	Equivalent strain rate at yield initiation to describe the rate dependency of the yield stress in Mode II (only considered if $S0 < 0$ )

VARIABLE	DESCRIPTION
FG2	Parameter $f_{G2}$ to describe the tri-linear shape of the traction-separation law in Mode II

**Remarks:**

The model is a tri-linear elastic-ideally plastic Cohesive Zone Model, which was developed by Marzi et al. [2009]. It looks similar to \*MAT\_185, but considers effects of plasticity and rate-dependency. Since the entire separation at failure is plastic, no brittle fracture behavior can be modeled with this material type.

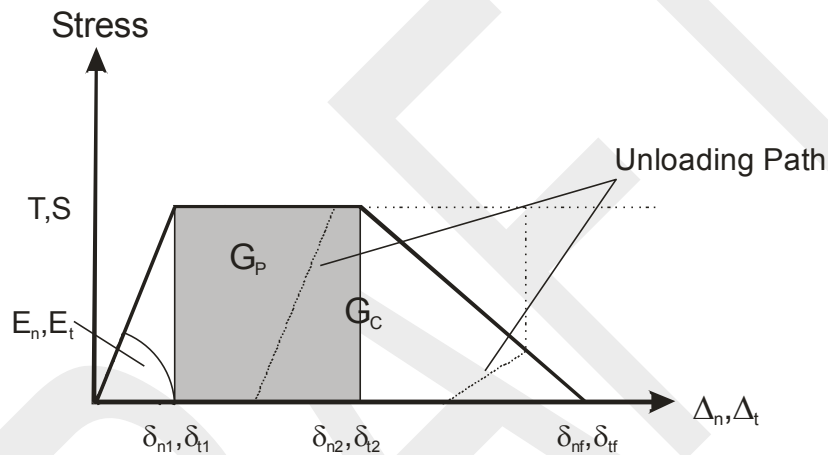

**Figure 240.1.** Trilinear traction-separation law

The separations  $\Delta_n$  in normal (peel) and  $\Delta_t$  in tangential (shear) direction are calculated from the element's separations in the integration points,

$$\Delta_n = \langle u_n \rangle \text{ and } \Delta_t = \sqrt{u_{t1}^2 + u_{t2}^2}, \langle x \rangle = \begin{cases} x & \text{if } x > 0 \\ 0 & \text{else} \end{cases}$$

$u_n, u_{t1}$  and  $u_{t2}$  are the separations in normal and in the both tangential directions of the element coordinate system. The total (mixed-mode) separation  $\Delta_m$  is determined by

$$\Delta_m = \sqrt{\Delta_n^2 + \Delta_t^2}$$

The initial stiffnesses in both modes are calculated from the elastic Young's and shear modulus,

$$E_n = EMODUL / THICK \text{ and } E_t = GMODUL / THICK,$$

where *THICK*, the element's thickness, is a user defined value if *THICK* > 0, otherwise it is calculated as distance between the initial positions of the element's corner nodes (Nodes 1-5, 2-6, 3-7 and 4-8, respectively).

While the total energy under the traction-separation law is given by  $G_C$ , one further parameter is needed to describe the exact shape of the tri-linear material model. If the area (energy) under the constant stress (plateau) region is denoted  $G_p$  (see Figure 240.1), a parameter  $f_G$  defines the shape of the traction-separation law,

$$0 \leq f_{G1} = \frac{G_{I,P}}{G_{IC}} < 1 - \frac{T^2}{2G_{IC}E_n} < 1 \quad \text{for mode I loading and}$$

$$0 \leq f_{G2} = \frac{G_{II,P}}{G_{IIC}} < 1 - \frac{S^2}{2G_{IIC}E_t} < 1 \quad \text{for mode II.}$$

While  $f_{G1}$  and  $f_{G2}$  are always constant values,  $T, S, G_{IC}$  and  $G_{IIC}$  may be chosen as functions of an equivalent strain rate  $\dot{\epsilon}_{eq}$ , which is evaluated by

$$\dot{\epsilon}_{eq} = \frac{\sqrt{\dot{u}_n^2 + \dot{u}_{t1}^2 + \dot{u}_{t2}^2}}{THICK},$$

where  $\dot{u}_n, \dot{u}_{t1}$  and  $\dot{u}_{t2}$  are the velocities corresponding to the separations  $u_n, u_{t1}$  and  $u_{t2}$ .

For the yield stresses, two rate dependent formulations are implemented:

1. A quadratic logarithmic function:

$$T(\dot{\epsilon}_{eq}) = |T0| + |T1| \left\langle \ln \frac{\dot{\epsilon}_{eq}}{EDOT\_T} \right\rangle^2 \quad \text{in Mode I, if } T0 < 0 \text{ and } T1 > 0, \text{ and}$$

$$S(\dot{\epsilon}_{eq}) = |S0| + |S1| \left\langle \ln \frac{\dot{\epsilon}_{eq}}{EDOT\_S} \right\rangle^2 \quad \text{in Mode II, if } S0 < 0 \text{ and } S1 > 0.$$

2. A linear logarithmic function:

$$T(\dot{\epsilon}_{eq}) = |T0| + |T1| \left\langle \ln \frac{\dot{\epsilon}_{eq}}{EDOT\_T} \right\rangle \quad \text{in Mode I, if } T0 < 0 \text{ and } T1 < 0, \text{ and}$$

$$S(\dot{\epsilon}_{eq}) = |S0| + |S1| \left\langle \ln \frac{\dot{\epsilon}_{eq}}{EDOT\_S} \right\rangle \quad \text{in Mode II, if } S0 < 0 \text{ and } S1 < 0.$$

Alternatively, T and S can be chosen as constant values:

$$T(\dot{\epsilon}_{eq}) = T0 \quad \text{in Mode I, if } T0 > 0, \text{ and } S(\dot{\epsilon}_{eq}) = S0 \quad \text{in Mode II, if } S0 > 0.$$

The rate-dependency of the fracture energies are given by

$$G_{IC}(\dot{\epsilon}_{eq}) = |G1C\_0| + (G1C\_INF - |G1C\_0|) \exp\left(-\frac{EDOT\_G1}{\dot{\epsilon}_{eq}}\right), \quad \text{if } G1C\_0 < 0, \text{ and}$$

$$G_{IIC}(\dot{\epsilon}_{eq}) = |G2C\_0| + (G2C\_INF - |G2C\_0|) \exp\left(-\frac{EDOT\_G2}{\dot{\epsilon}_{eq}}\right), \quad \text{if } G2C\_0 < 0.$$

If positive values are chosen for  $G1C\_0$  or  $G2C\_0$ , no rate-dependency is considered for this parameter and its value remains constant as specified by the user.

It should be noticed, that the equivalent strain rate  $\dot{\epsilon}_{eq}$  is updated until  $\Delta_m > \delta_{m1}$ , then the model behavior depends on the equivalent strain rate at yield initiation.

Having defined the parameters describing the single modes, the mixed-mode behavior is formulated by quadratic initiation criteria for both yield stress and damage initiation, while the damage evolution follows a Power-Law.

Due to reasons of readability, the following simplifications are made,

$$T = T(\dot{\epsilon}_{eq}), S = S(\dot{\epsilon}_{eq}), G_{IC} = G_{IC}(\dot{\epsilon}_{eq}) \text{ and } G_{IIC} = G_{IIC}(\dot{\epsilon}_{eq}).$$

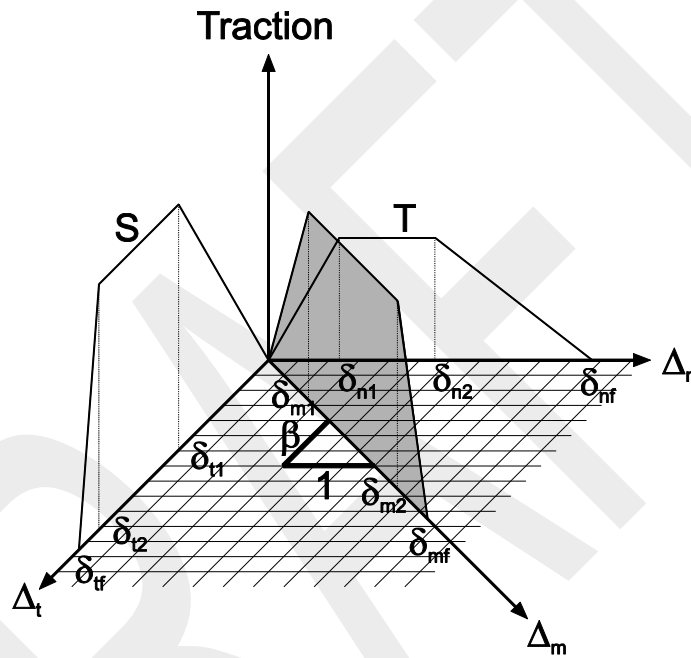

Figure 240.2. Trilinear, mixed-mode traction-separation law

The mixed-mode yield initiation displacement  $\delta_{m1}$  is defined as

$$\delta_{m1} = \delta_{n1} \delta_{t1} \sqrt{\frac{1 + \beta^2}{\delta_{t1}^2 + (\beta \delta_{n1})^2}},$$

where  $\delta_{n1} = \frac{T}{E_n}$  and  $\delta_{t1} = \frac{S}{E_t}$  are the single-mode yield initiation displacements and  $\beta = \frac{\delta_{t1}}{\delta_{n1}}$  is the mixed-mode ratio. Analog to the yield initiation, the damage initiation displacement  $\delta_{m2}$  is defined:

$$\delta_{m2} = \delta_{n2} \delta_{t2} \sqrt{\frac{1 + \beta^2}{\delta_{t2}^2 + (\beta \delta_{n2})^2}}, \text{ with } \delta_{n2} = \delta_{n1} + \frac{f_{G1} G_{IC}}{T} \text{ and } \delta_{t2} = \delta_{t1} + \frac{f_{G2} G_{IIC}}{S}.$$

With  $\gamma = \arccos\left(\frac{\langle u_n \rangle}{\Delta_m}\right)$ , the ultimate (failure) displacement  $\delta_{mf}$  can be written,

$$\delta_{mf} = \frac{\delta_{m1}(\delta_{m1} - \delta_{m2})E_n G_{IIC} \cos^2 \gamma + G_{IC} (2G_{IIC} + \delta_{m1}(\delta_{m1} - \delta_{m2})E_t \sin^2 \gamma)}{\delta_{m1}(E_n G_{IIC} \cos^2 \gamma + E_t G_{IC} \sin^2 \gamma)}.$$

This formulation describes a power-law damage evolution with an exponent  $\eta = 1.0$  (see \*MAT\_138).

After the shape of the mixed-mode traction-separation law has been determined by  $\delta_{m1}$ ,  $\delta_{m2}$  and  $\delta_{mf}$ , the plastic separation in each element direction,  $u_{n,P}$ ,  $u_{t1,P}$  and  $u_{t2,P}$  can be calculated. The plastic separation in peel direction is given by

$$u_{n,P} = \max(u_{n,P,\Delta t-1}, u_n - \delta_{m1} \sin \gamma, 0).$$

In shear direction, a shear yield separation  $\delta_{t,y}$ ,

$$\delta_{t,y} = \sqrt{(u_{t1} - u_{t1,P,\Delta t-1})^2 + (u_{t2} - u_{t2,P,\Delta t-1})^2},$$

is defined. If  $\delta_{t,y} > \delta_{m1} \sin \gamma$ , the plastic shear separations in the element coordinate system are updated,

$$u_{t1,P} = u_{t1,P,\Delta t-1} + u_{t1} - u_{t1,\Delta t-1}, \quad \text{and} \quad u_{t2,P} = u_{t2,P,\Delta t-1} + u_{t2} - u_{t2,\Delta t-1}.$$

In the formulas above,  $\Delta t - 1$  indicates the individual value from the last time increment. In case  $\Delta_m > \delta_{m2}$ , the damage initiation criterion is satisfied and a damage variable  $D$  increases monotonically,

$$D = \max\left(\frac{\Delta_m - \delta_{m2}}{\delta_{mf} - \delta_{m2}}, D_{\Delta t-1}, 0\right).$$

When  $\Delta_m > \delta_{mf}$ , complete damage ( $D = 1$ ) is reached and the element fails in the corresponding integration point.

Finally, the peel and the shear stresses in element directions are calculated,

$$\sigma_{t1} = E_t (1 - D)(u_{t1} - u_{t1,P}), \quad \text{and} \quad \sigma_{t2} = E_t (1 - D)(u_{t2} - u_{t2,P}).$$

In peel direction, no damage under pressure loads is considered,

$$\sigma_n = E_n (1 - D)(u_n - u_{n,P}), \quad \text{if } u_n - u_{n,P} > 0 \quad \text{and} \quad \sigma_n = E_n (u_n - u_{n,P}) \quad \text{else.}$$

#### Reference:

S. Marzi, O. Hesebeck, M. Brede and F. Kleiner (2009), A Rate-Dependent, Elasto-Plastic Cohesive Zone Mixed-Mode Model for Crash Analysis of Adhesively Bonded Joints, In Proceeding: 7<sup>th</sup> European LS-DYNA Conference, Salzburg

\*MAT\_JOHNSON\_HOLMQUIST\_JH1

This is Material Type 241. This Johnson-Holmquist Plasticity Damage Model is useful for modeling ceramics, glass and other brittle materials. This version corresponds to the original version of the model, JH1, and Material Type 110 corresponds to JH2, the updated model.

Card 1            1            2            3            4            5            6            7            8

Variable	MID	RO	G	P1	S1	P2	S2	C
Type	A8	F	F	F	F	F	F	F

Card 2            1            2            3            4            5            6            7            8

Variable	EPSI	T		ALPHA	SFMAX	BETA	DP1	
Type	F	F	F	F	F	F	F	

Card 3            1            2            3            4            5            6            7            8

Variable	EPFMIN	EPFMAX	K1	K2	K3	FS		
Type	F	F	F	F	F	F		

**VARIABLE**

**DESCRIPTION**

- MID            Material identification. A unique number or label not exceeding 8 characters must be specified.
- RO            Density.
- G            Shear modulus.
- P1            Pressure point 1 for intact material.
- S1            Effective stress at P1.
- P2            Pressure point 2 for intact material.

VARIABLE	DESCRIPTION
S2	Effective stress at P2.
C	Strain rate sensitivity factor.
EPSI	Quasi-static threshold strain rate. See *MAT_015.
T	Maximum tensile pressure strength. This value is positive in tension.
ALPHA	Initial slope of the fractured material strength curve. See Figure 241.1
SFMAX	Maximum strength of the fractured material.
BETA	Fraction of elastic energy loss converted to hydrostatic energy (affects bulking pressure (history variable 1) that accompanies damage).
DP1	Maximum compressive pressure strength. This value is positive in compression.
EPFMIN	Plastic strain for fracture at tensile pressure T. See Figure 241.2.
EPFMAX	Plastic strain for fracture at compressive pressure DP1. See Figure 241.2.
K1	First pressure coefficient (equivalent to the bulk modulus).
K2	Second pressure coefficient.
K3	Third pressure coefficient.
FS	Element deletion criteria. FS < 0 delete if P < FS (tensile failure). FS = 0 no element deletion (default). FS > 0 delete element if the $\bar{\epsilon}^p > FS$ .

**Remarks:**

The equivalent stress for both intact and fractured ceramic-type materials is given by

$$\sigma_y = (1 + c \ln \dot{\epsilon}^*) \sigma(P)$$

where  $\sigma(P)$  is evaluated according Figure 241.1.

$$D = \sum \Delta \epsilon^p / \epsilon_f^p(P)$$

Represents the accumulated damage (history variable 2) based upon the increase in plastic strain per computational cycle and the plastic strain to fracture is evaluated according to Figure 241.2.



In undamaged material, the hydrostatic pressure is given by

$$P = k_1\mu + k_2\mu^2 + k_3\mu^3 + \Delta P$$

in compression and

$$P = k_1\mu + \Delta P$$

in tension where  $\mu = \rho/\rho_0 - 1$ . A fraction, between 0 and 1, of the elastic energy loss,  $\beta$ , is converted into hydrostatic potential energy (pressure). The pressure increment,  $\Delta P$ , associated with the increment in the hydrostatic potential energy is calculated at fracture, where  $\sigma_y$  and  $\sigma_y^f$  are the intact and failed yield stresses respectively. This pressure increment is applied both in compression and tension, which is not true for JH2 where the increment is added only in compression.

$$\Delta P = -k_1\mu_f + \sqrt{(k_1\mu_f)^2 + 2\beta k_1\Delta U}$$

$$\Delta U = \frac{\sigma_y - \sigma_y^f}{6G}$$

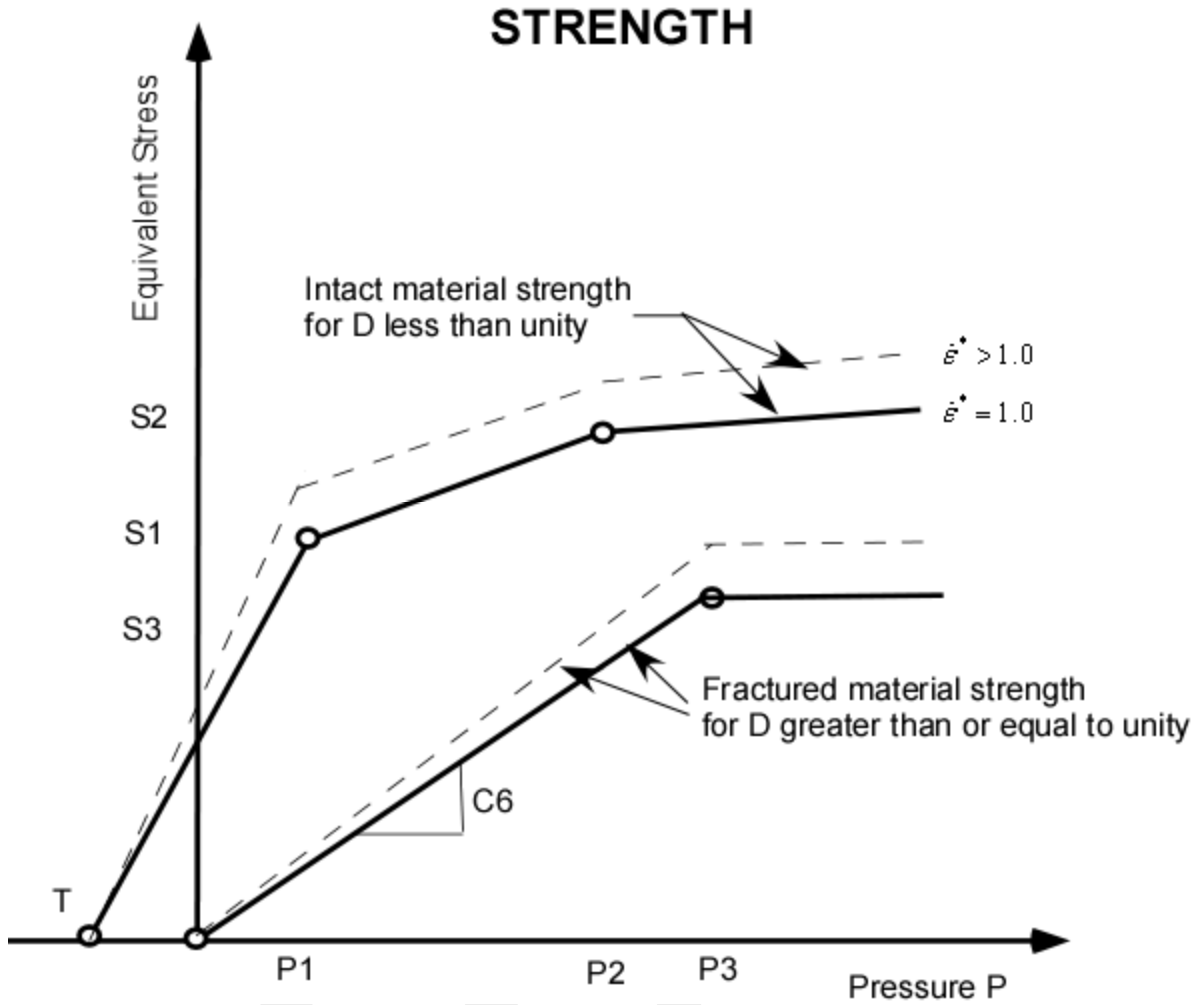

Figure 241.1. Equivalent stress versus pressure.

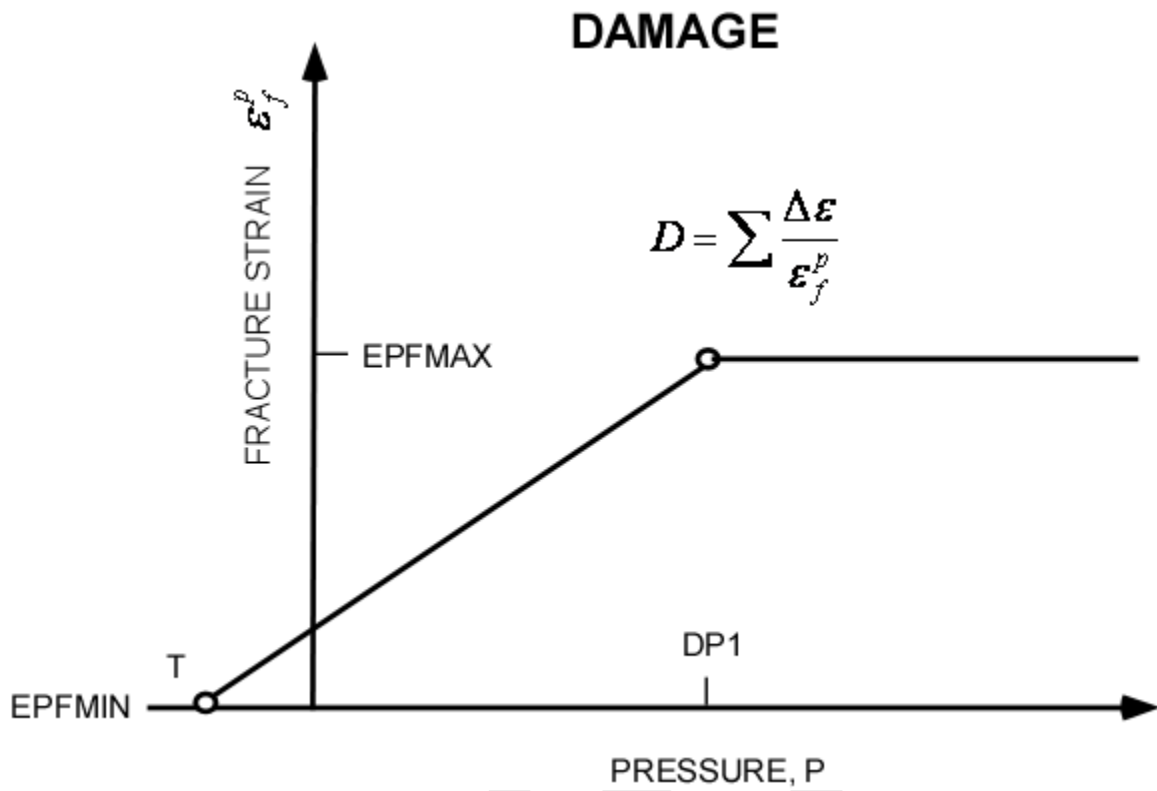

Figure 241.2. Fracture strain versus pressure.

**\*MAT\_KINEMATIC\_HARDENING\_BARLAT2000**

This is Material Type 242. This model combines Yoshida non-linear kinematic hardening rule (\*MAT\_125) with the 8-parameter material model of Barlat and Lian (2003) (\*MAT\_133) to model metal sheets under cyclic plasticity loading and with anisotropy in plane stress condition. Also see manual pages in \*MAT\_226.

Card 1            1            2            3            4            5            6            7            8

Variable	MID	RO	E	PR			M	
Type	I	F	F	F			F	
Default	none	0.0	0.0	0.0			none	

Card 2            1            2            3            4            5            6            7            8

Variable	ALPHA1	ALPHA2	ALPHA3	ALPHA4	ALPHA5	ALPHA6	ALPHA7	ALPHA8
Type	F	F	F	F	F	F	F	I
Default	0.0	0.0	0.0	0.0	0.0	0.0	0.0	none

Card 3            1            2            3            4            5            6            7            8

Variable								
Type								
Default								

Card 4            1            2            3            4            5            6            7            8

Variable								
Type								
Default								

Card 5            1            2            3            4            5            6            7            8

Variable	CB	Y	C	K	RSAT	SB	H	
Type	F	F	F	F	F	F	F	
Default	none	none	none	none	none	none	none	

Card 6            1            2            3            4            5            6            7            8

Variable	AOPT		IOPT	C1	C2			
Type	I		I	F	F			
Default	none		none	0.0	0.0			

Card 7            1            2            3            4            5            6            7            8

Variable	XP	YP	ZP	A1	A2	A3		
Type	F	F	F	F	F	F		
Default	none	none	none	none	none	none		

Card 8            1            2            3            4            5            6            7            8

Variable	V1	V2	V3	D1	D2	D3		
Type	F	F	F	F	F	F		
Default	none	none	none	none	none	none		

**VARIABLE****DESCRIPTION**

MID	Material identification. A unique number must be specified.
RO	Mass density,
E	Young's modulus, E,
PR	Poisson's ratio, $\nu$ ,
M	Flow potential exponent,
ALPHA1	$\alpha_1$ , material constant in Barlat's yield equation,
ALPHA2	$\alpha_2$ , material constant in Barlat's yield equation,
ALPHA3	$\alpha_3$ , material constant in Barlat's yield equation,
ALPHA4	$\alpha_4$ , material constant in Barlat's yield equation,
ALPHA5	$\alpha_5$ , material constant in Barlat's yield equation,
ALPHA6	$\alpha_6$ , material constant in Barlat's yield equation,
ALPHA7	$\alpha_7$ , material constant in Barlat's yield equation,
ALPHA8	$\alpha_8$ , material constant in Barlat's yield equation,
CB	The uppercase B defined in the Yoshida's equations,
Y	Anisotropic parameter associated with work-hardening stagnation, defined in the Yoshida's equations,
SC	The lowercase c defined in the Yoshida's equations,
K	Hardening parameter as defined in the Yoshida's equations,

VARIABLE	DESCRIPTION
RSAT	Hardening parameter as defined in the Yoshida's equations,
SB	The lowercase b as defined in the Yoshida's equations,
H	Anisotropic parameter associated with work-hardening stagnation, defined in the following Yoshida's equations,
AOPT	Material axes option (see MAT_OPTION TROPIC_ELASTIC for a more complete description): EQ.0.0: locally orthotropic with material axes determined by element nodes 1, 2, and 4, as with *DEFINE_COORDINATE_NODES. EQ.2.0: globally orthotropic with material axes determined by vectors defined below, as with *DEFINE_COORDINATE_VECTOR. EQ.3.0: locally orthotropic material axes determined by rotating the material axes about the element normal by an angle, BETA, from a line in the plane of the element defined by the cross product of the vector v with the element normal. LT.0.0: the absolute value of AOPT is a coordinate system ID number (CID on *DEFINE_COORDINATE_NODES, *DEFINE_COORDINATE_SYSTEM or *DEFINE_COORDINATE_VECTOR). Available with the R3 release of Version 971 and later.
IOPT	Kinematic hardening rule flag: EQ.0: Original Yoshida formulation, EQ.1: Modified formulation. Define C1, C2 below,
C1, C2	Constants used to modify R: $R = RSAT \left[ (C_1 + \bar{\epsilon}^p)^{c_2} - C_1^{c_2} \right]$
XP, YP, ZP	Coordinates of point <b>p</b> for AOPT = 1,
A1, A2, A3	Components of vector <b>a</b> for AOPT = 2,
V1, V2, V3	Components of vector <b>v</b> for AOPT = 3,
D1, D2, D3	Components of vector <b>d</b> for AOPT = 2.

### Remarks:

1. A total of eight parameters ( $\alpha_1$  to  $\alpha_8$ ) are needed to describe the yield surface. The parameters can be determined with tensile tests in three directions and an equal biaxial tension test. For detailed theoretical background and material parameters of some typical FCC materials, please see remarks in \*MAT\_133 and Barlat's 2003 paper.

2. NUMISHEET 2005 provided a complete set of the parameters of AL5182-O for Benchmark #2, the cross member, as below (flow potential exponent  $M=8$ ):

$\alpha_1$	$\alpha_2$	$\alpha_3$	$\alpha_4$	$\alpha_5$	$\alpha_6$	$\alpha_7$	$\alpha_8$
0.94	1.08	0.97	1.0	1.0	1.02	1.03	1.11

3. For a more detailed description on the Yoshida model and parameters, please see Remarks in \*MAT\_226 and \*MAT\_125.
4. For information on variable AOPT please see remarks in \*MAT\_226.
5. To improve convergence, it is recommended that \*CONTROL\_IMPLICIT\_FORMING type '1' be used when conducting springback simulation.
6. This material model is available in LS-DYNA R5 Revision 58432 or later releases.



\*MAT\_HILL\_90

This is Material Type 243. This model was developed by Hill [1990] for modeling sheets with anisotropic materials under plane stress conditions. This material allows the use of the Lankford parameters for the definition of the anisotropy. All features of this model are the same as in \*MAT\_036, only the yield condition and associated flow rules are replaced by the Hill90 equations.

Card 1            1            2            3            4            5            6            7            8

Variable	MID	RO	E	PR	HR	P1	P2	ITER
Type	A8	F	F	F	F	F	F	F

Card 2            1            2            3            4            5            6            7            8

Variable	M	R00 / AH	R45 / BH	R90 / CH	LCID	E0	SPI	P3
Type	F	F	F	F	I	F	F	F

**Define the following card if and only if M<0**

Card opt.        1            2            3            4            5            6            7            8

Variable	CRC1	CRA1	CRC2	CRA2	CRC3	CRA3	CRC4	CRA4
Type	F	F	F	F	F	F	F	F

Card 3            1            2            3            4            5            6            7            8

Variable	AOPT	C	P	VLCID		FLAG		
Type	F	F	F	I		F		

Card 4            1            2            3            4            5            6            7            8

Variable				A1	A2	A3		
Type				F	F	F		

Card 5            1            2            3            4            5            6            7            8

Variable	V1	V2	V3	D1	D2	D3	BETA	
Type	F	F	F	F	F	F	F	

**VARIABLE**

**DESCRIPTION**

- MID            Material identification. A unique number or label not exceeding 8 characters must be specified.
  
- RO            Mass density.
  
- E            Young's modulus, E  
              GT.0.0: Constant value,  
              LT.0.0: Load curve ID = (-E) which defines Young's Modulus as a function of plastic strain. See Remark 1.
  
- PR            Poisson's ratio,  $\nu$
  
- HR            Hardening rule:  
              EQ.1.0: linear (default),  
              EQ.2.0: exponential (Swift)  
              EQ.3.0: load curve or table with strain rate effects  
              EQ.4.0: exponential (Voce)  
              EQ.5.0: exponential (Gosh)  
              EQ.6.0: exponential (Hockett-Sherby)  
              EQ.7.0: load curves in three directions  
              EQ.8.0: table with temperature dependence  
              EQ.9.0: 3d table with temperature and strain rate dependence

VARIABLE	DESCRIPTION
P1	Material parameter: HR.EQ.1.0: Tangent modulus, HR.EQ.2.0: k, strength coefficient for Swift exponential hardening HR.EQ.4.0: a, coefficient for Voce exponential hardening HR.EQ.5.0: k, strength coefficient for Gosh exponential hardening HR.EQ.6.0: a, coefficient for Hocket-Sherby exponential hardening HR.EQ.7.0: load curve ID for hardening in 45 degree direction. See Remark 2.
P2	Material parameter: HR.EQ.1.0: Yield stress HR.EQ.2.0: n, exponent for Swift exponential hardening HR.EQ.4.0: c, coefficient for Voce exponential hardening HR.EQ.5.0: n, exponent for Gosh exponential hardening HR.EQ.6.0: c, coefficient for Hocket-Sherby exponential hardening HR.EQ.7.0: load curve ID for hardening in 90 degree direction. See Remark 2.
ITER	Iteration flag for speed: ITER.EQ.0.0: fully iterative ITER.EQ.1.0: fixed at three iterations Generally, ITER=0 is recommended. However, ITER=1 is somewhat faster and may give acceptable results in most problems.
M	m, exponent in Hill's yield surface, absolute value is used if negative. Typically, m ranges between 1 and 2 for low-r materials, such as aluminum (AA6111: $m \approx 1.5$ ), and is greater than 2 for high r-values, as in steel (DP600: $m \approx 4$ ).
CRCN	Chaboche-Roussiler hardening parameter, see remarks.
CRCA	Chaboche-Roussiler hardening parameter, see remarks.
R00	R00, Lankford parameter in 0 degree direction GT.0.0: Constant value, LT.0.0: Load curve or Table ID = (-R00) which defines R value as a function of plastic strain (Curve) or as a function of temperature and plastic strain (Table). See Remark 3.
R45	R45, Lankford parameter in 45 degree direction GT.0.0: Constant value, LT.0.0: Load curve or Table ID = (-R45) which defines R value as a function of plastic strain (Curve) or as a function of temperature and plastic strain (Table). See Remarks 2 and 3.

VARIABLE	DESCRIPTION
R90	R <sub>90</sub> , Lankford parameter in 90 degree direction GT.0.0: Constant value, LT.0.0: Load curve or Table ID = (-R90) which defines R value as a function of plastic strain (Curve) or as a function of temperature and plastic strain (Table). See Remarks 2 and 3.
AH	a, Hill90 parameter, which is read instead of R00 if FLAG=1.
BH	b, Hill90 parameter, which is read instead of R45 if FLAG=1.
CH	c, Hill90 parameter, which is read instead of R90 if FLAG=1.
LCID	Load curve/table ID for hardening in the 0 degree direction. See Remark 1.
E0	Material parameter HR.EQ.2.0: $\epsilon_0$ for determining initial yield stress for Swift exponential hardening. (Default=0.0) HR.EQ.4.0: b, coefficient for Voce exponential hardening HR.EQ.5.0: $\epsilon_0$ for determining initial yield stress for Gosh exponential hardening. (Default=0.0) HR.EQ.6.0: b, coefficient for Hocket-Sherby exponential hardening
SPI	<i>spi</i> , if $\epsilon_0$ is zero above and HR.EQ.2.0. (Default=0.0) EQ.0.0: $\epsilon_0 = (E/k)^{**}[1/(n-1)]$ LE.0.02: $\epsilon_0 = spi$ GT.0.02: $\epsilon_0 = (spi/k)^{**}[1/n]$ If HR.EQ.5.0 the strain at plastic yield is determined by an iterative procedure based on the same principles as for HR.EQ.2.0.
P3	Material parameter: HR.EQ.5.0: p, parameter for Gosh exponential hardening HR.EQ.6.0: n, exponent for Hocket-Sherby exponential hardening

VARIABLE	DESCRIPTION
AOPT	<p>Material axes option (see <i>MAT_OPTION</i> TROPIC_ELASTIC for a more complete description):</p> <p>EQ.0.0: locally orthotropic with material axes determined by element nodes 1, 2, and 4, as with *DEFINE_COORDINATE_NODES, and then rotated about the shell element normal by the angle BETA.</p> <p>EQ.2.0: globally orthotropic with material axes determined by vectors defined below, as with *DEFINE_COORDINATE_VECTOR.</p> <p>EQ.3.0: locally orthotropic material axes determined by rotating the material axes about the element normal by an angle, BETA, from a line in the plane of the element defined by the cross product of the vector <i>v</i> with the element normal.</p> <p>LT.0.0: the absolute value of AOPT is a coordinate system ID number (CID on *DEFINE_COORDINATE_NODES, *DEFINE_COORDINATE_SYSTEM or *DEFINE_COORDINATE_VECTOR). Available with the R3 release of Version 971 and later.</p>
C	C in Cowper-Symonds strain rate model
P	p in Cowper-Symonds strain rate model, p=0.0 for no strain rate effects
VLCID	Volume correction curve ID defining the relative volume change (change in volume relative to the initial volume) as a function of the effective plastic strain. This is only used when nonzero. See Remark 1.
FLAG	Flag for interpretation of parameters. If FLAG=1, parameters AH, BH, and CH are read instead of R00, R45, and R90. See Remark 4.
XP YP ZP	Coordinates of point <b>p</b> for AOPT = 1.
A1 A2 A3	Components of vector <b>a</b> for AOPT = 2.
V1 V2 V3	Components of vector <b>v</b> for AOPT = 3.
D1 D2 D3	Components of vector <b>d</b> for AOPT = 2.
BETA	Material angle in degrees for AOPT = 0 and 3, may be overridden on the element card, see *ELEMENT_SHELL_BETA.

### Remarks:

- The effective plastic strain used in this model is defined to be plastic work equivalent. A consequence of this is that for parameters defined as functions of effective plastic strain,

the rolling (00) direction should be used as reference direction. For instance, the hardening curve for HR=3 is the stress as function of strain for uniaxial tension in the rolling direction, VLCID curve should give the relative volume change as function of strain for uniaxial tension in the rolling direction and load curve given by -E should give the Young's modulus as function of strain for uniaxial tension in the rolling direction. Optionally the curve can be substituted for a table defining hardening as function of plastic strain rate (HR=3) or temperature (HR=8).

- 5. Exceptions from the rule above are curves defined as functions of plastic strain in the 45 and 90 directions, i.e., P1 and P2 for HR=7 and negative R45 or R90. The hardening curves are here defined as measured stress as function of measured plastic strain for uniaxial tension in the direction of interest, i.e., as determined from experimental testing using a standard procedure. Moreover, the curves defining the R values are as function of the measured plastic strain for uniaxial tension in the direction of interest. These curves are transformed internally to be used with the effective stress and strain properties in the actual model. The effective plastic strain does not coincide with the plastic strain components in other directions than the rolling direction and may be somewhat confusing to the user. Therefore the von Mises work equivalent plastic strain is output as history variable #2 if HR=7 or if any of the R-values is defined as function of the plastic strain.
- 6. The R-values in curves are defined as the ratio of instantaneous width change to instantaneous thickness change. That is, assume that the width W and thickness T are measured as function of strain. Then the corresponding R-value is given by:

$$R = \frac{\frac{dW}{d\varepsilon} / W}{\frac{dT}{d\varepsilon} / T}$$

- 4. The anisotropic yield criterion  $\Phi$  for plane stress is defined as:

$$\Phi = K_1^m + K_3 \cdot K_2^{(m/2)-1} + c^m \cdot K_4^{m/2} = (1 + c^m - 2a + b) \sigma_y^m$$

where  $\sigma_y$  is the yield stress and  $K_{i=1,4}$  are given by:

$$K_1 = |\sigma_x + \sigma_y|$$

$$K_2 = |\sigma_x^2 + \sigma_y^2 + 2\sigma_{xy}^2|$$

$$K_3 = -2a(\sigma_x^2 - \sigma_y^2) + b(\sigma_x - \sigma_y)^2$$

$$K_4 = |(\sigma_x - \sigma_y)^2 + 4\sigma_{xy}^2|$$

If FLAG=0, the anisotropic material constants a, b, and c are obtained through R<sub>00</sub>, R<sub>45</sub>, and R<sub>90</sub> using these 3 equations:

$$1 + 2R_{00} = \frac{c^m - a + \{(m+2)/2m\}b}{1 - a + \{(m-2)/2m\}b}$$

$$1 + 2R_{45} = c^m$$

$$1 + 2R_{90} = \frac{c^m + a + \{(m+2)/2m\}b}{1 + a + \{(m-2)/2m\}b}$$

If FLAG=1, material parameters a (AH), b (BH), and c (CH) are used directly.

For material parameters a, b, c, and m, the following condition has to be fulfilled, otherwise an error termination occurs:

$$1 + c^m - 2a + b > 0$$

Two even more strict conditions should ensure convexity of the yield surface according to Hill (1990). A warning message will be dumped if at least one of them is violated:

$$b > -2^{(m/2)-1} c^m$$

$$b > a^2 - c^m$$

The yield strength of the material can be expressed in terms of k and n:

$$\sigma_Y = k \varepsilon^n = k (\varepsilon_{yp} + \bar{\varepsilon}^p)^n$$

where  $\varepsilon_{yp}$  is the elastic strain to yield and  $\bar{\varepsilon}^p$  is the effective plastic strain (logarithmic).

If SIGY is set to zero, the strain to yield is found by solving for the intersection of the linearly elastic loading equation with the strain hardening equation:

$$\sigma = E \varepsilon$$

$$\sigma = k \varepsilon^n$$

which gives the elastic strain at yield as:

$$\varepsilon_{yp} = \left( \frac{E}{k} \right)^{\left[ \frac{1}{n-1} \right]}$$

If SIGY yield is nonzero and greater than 0.02 then:

$$\varepsilon_{yp} = \left( \frac{\sigma_Y}{k} \right)^{\left[ \frac{1}{n} \right]}$$

The other available hardening models include the Voce equation given by

$$\sigma_Y(\varepsilon_p) = a - be^{-c\varepsilon_p},$$

the Gosh equation given by

$$\sigma_Y(\varepsilon_p) = k(\varepsilon_0 + \varepsilon_p)^n - p,$$

and finally the Hockett-Sherby equation given by

$$\sigma_Y(\varepsilon_p) = a - be^{-c\varepsilon_p^n}.$$

For the Gosh hardening law, the interpretation of the variable SPI is the same, i.e., if set to zero the strain at yield is determined implicitly from the intersection of the strain hardening equation with the linear elastic equation.

To include strain rate effects in the model we multiply the yield stress by a factor depending on the effective plastic strain rate. We use the Cowper-Symonds' model, hence the yield stress can be written

$$\sigma_Y(\varepsilon_p, \dot{\varepsilon}_p) = \sigma_Y^s(\varepsilon_p) \left\{ 1 + \left( \frac{\dot{\varepsilon}_p}{C} \right)^{1/p} \right\}$$

where  $\sigma_Y^s$  denotes the static yield stress,  $C$  and  $p$  are material parameters,  $\dot{\varepsilon}_p$  is the effective plastic strain rate.

5. A kinematic hardening model is implemented following the works of Chaboche and Roussilier. A back stress  $\alpha$  is introduced such that the effective stress is computed as

$$\sigma_{\text{eff}} = \sigma_{\text{eff}}(\sigma_{11} - 2\alpha_{11} - \alpha_{22}, \sigma_{22} - 2\alpha_{22} - \alpha_{11}, \sigma_{12} - \alpha_{12})$$

The back stress is the sum of up to four terms according to

$$\alpha_{ij} = \sum_{k=1}^4 \alpha_{ij}^k$$

and the evolution of each back stress component is as follows

$$\delta\alpha_{ij}^k = C_k \left( a_k \frac{s_{ij}}{\sigma_{\text{eff}}} - \alpha_{ij}^k \right) \delta\varepsilon_p$$

where  $C_k$  and  $a_k$  are material parameters,  $s_{ij}$  is the deviatoric stress tensor,  $\sigma_{\text{eff}}$  is the effective stress and  $\varepsilon_p$  is the effective plastic strain.



\*MAT\_UHS\_STEEL

This material model is developed for both shell and solid models. It is mainly suited for hot stamping processes where phase transformations are crucial. It has five phases and it is assumed that the blank is fully austenitized before cooling. The basic constitutive model is based on the work done by P. Akerstrom [2, 7].

Automatic switching between cooling and heating of the blank is under development. To activate the heating algorithm you need to set HEAT = 1 or 2 and add the appropriate input Cards. See the description of the HEAT parameter below. HEAT = 0 as is the default activates only the cooling algorithm and no extra cards need to be read in. Also note that for HEAT = 0 you **must** check that the initial temperature of this material is above the start temperature for the ferrite transformation. The transformation temperatures are echoed in the terminal, messag and in the d3hsp file.

If you are new to this material model please read the Remarks section where some of the parameters are explained in more detail.

**NOTE:** weight% = ppm \* 10<sup>-4</sup>

Card 1            1            2            3            4            5            6            7            8

Variable	MID	RO	E	PR	TUNIT	CRSH	PHASE	HEAT
Type	I	F	F	F	F	I	I	I
Defaults	none	none	none	none	3600	0	0	0

Card 2            1            2            3            4            5            6            7            8

Variable	LCY1	LCY2	LCY3	LCY4	LCY5	KFER	KPER	B
Type	I	I	I	I	I	F	F	F
Defaults	none	none	none	none	none	0.0	0.0	0.0

Card 3            1            2            3            4            5            6            7            8

Variable	C	Co	Mo	Cr	Ni	Mn	Si	V
Type	F	F	F	F	F	F	F	F
Defaults	0.0	0.0	0.0	0.0	0.0	0.0	0.0	0.0

Card 4            1            2            3            4            5            6            7            8

Variable	W	Cu	P	Al	As	Ti		
Type	F	F	F	F	F	F		
Defaults	0.0	0.0	0.0	0.0	0.0	0.0		

Card 5            1            2            3            4            5            6            7            8

Variable	THEXP1	THEXP5	LCTH1	LCTH5	TREF	LAT1	LAT5	
Type	F	F	I	I	F	F	F	
Defaults	0.0	0.0	none	none	273.15	0.0	0.0	

Card 6            1            2            3            4            5            6            7            8

Variable	QR2	QR3	QR4	ALPHA	GRAIN	TOFFE	TOFPE	TOFBA
Type	F	F	F	F	F	F	F	F
Defaults	0.0	0.0	0.0	0.0	0.0	0.0	0.0	0.0

Card 7            1            2            3            4            5            6            7            8

Variable	PLMEM2	PLMEM3	PLMEM4	PLMEM5	STRC	STRP		
Type	I	F	F	F	F	F		
Defaults	0.0	0.0	0.0	0.0	0.0	0.0		

Card 8\*            1            2            3            4            5            6            7            8

Variable	AUST	FERR	PEAR	BAIN	MART	GRK	GRQR	TAU1
Type	F	F	F	F	F	F	F	F
Default	0.0	0.0	0.0	0.0	0.0	0.0	0.0	2.08E+8

Card 9\*            1            2            3            4            5            6            7            8

Variable	GRA	GRB	EXPA	EXPB	GRCC	GRCM	HEATN	TAU2
Type	F	F	F	F	F	F	F	F
Default	3.11	7520.	1.0	1.0	None	None	1.0	4.806

\*Define input Card 8 and 9 only if HEAT activated..

<u>VARIABLE</u>	<u>DESCRIPTION</u>	<u>BASELINE VALUE</u>
MID	Material ID, a unique number has to be chosen.	
RO	Material density	7830 Kg/m <sup>3</sup>
E	Youngs' modulus: GT.0.0: constant value is used LT.0.0: temperature dependent Youngs'	100.e+09 Pa [1]

VARIABLE	DESCRIPTION	BASELINE VALUE
	modulus given by load curve ID = -E	
PR	Poisson's ratio	0.30 [1]
TUNIT	Number of time units per hour. Default is seconds, that is 3600 time units per hour. It is used only for hardness calculations.	3600.
CRSH	Switch to use a simple and fast material model but with the actual phases active. EQ.0: The original model were phase transitions are active and trip is used. EQ.1: A simpler and faster version. This option is mainly when transferring the quenched blank into a crash analysis where all properties from the cooling are maintained. This option must be used with a *INTERFACE_SPRINGBACK keyword and should be used after a quenching analysis.	0
PHASE	Switch to exclude middle phases from the simulation. EQ.0: All phases ACTIVE default) EQ.1: pearlite and bainite ACTIVE EQ.2: bainite ACTIVE EQ.3: ferrite and pearlite ACTIVE EQ.4: ferrite and bainite ACTIVE EQ.5: NO ACTIVE middle phases (only austenite -> martensite)	0
HEAT	Switch to activate the heating algorithms EQ.0: Heating is <i>not</i> activated. That means that no transformation to Austenite is possible. EQ.1: Heating <i>is</i> activated. That means that only transformation to Austenite is possible. EQ.2: <i>Automatic</i> switching between cooling and heating. LS-DYNA checks the temperature gradient and calls the appropriate algorithms. For example, this can be used to simulate the heat affected zone during welding. LT.0: Switch between cooling and heating is defined by a time dependent <i>load curve</i> with index ABS(HEAT). The ordinate should be 1.0 when heating is applied and 0.0 if cooling	

<u>VARIABLE</u>	<u>DESCRIPTION</u>	<u>BASELINE VALUE</u>
	is preferable. Note that the function value is rounded to nearest integer.	
LCY1	Load curve or Table ID for austenite hardening. IF LCID: input yield stress versus effective plastic strain. IF TABID.GT.0: 2D table. Input temperatures as table values and hardening curves as targets for those temperatures (see *DEFINE_TABLE) IF TABID.LT.0: 3D table. Input temperatures as main table values and strain rates as values for the sub tables, and hardening curves as targets for those strain rates.	[5]
LCY2	Load curve ID for ferrite hardening (stress versus eff. pl. str.)	
LCY3	Load curve or Table ID for pearlite. See LCY1 for description.	
LCY4	Load curve or Table ID for bainite. See LCY1 for description.	
LCY5	Load curve or Table ID for martensite. See LCY1 for description.	
KFERR	Correction factor for boron in the ferrite reaction.	1.9e+05 [2]
KPEAR	Correction factor for boron in the pearlite reaction.	3.1e+03 [2]
B	Boron [weight %]	0.003 [2, 4]
C	Carbon [weight %]	0.23 [2, 4]
Co	Cobolt [weight %]	0.0 [2, 4]
Mo	Molybdenum [weight %]	0.0 [2, 4]
Cr	Chromium [weight %]	0.21 [2, 4]
Ni	Nickel [weight %]	0.0 [2, 4]

<b>VARIABLE</b>	<b>DESCRIPTION</b>	<b>BASELINE VALUE</b>
Mn	Manganese [weight %]	1.25 [2, 4]
Si	Silicon [weight %]	0.29 [2, 4]
V	Vanadium [weight %]	0.0 [2, 4]
W	Tungsten [weight %]	0.0
Cu	copper [weight %]	0.0
P	Phosphorous [weight %]	0.013
Al	Aluminium [weight %]	0.0
As	Arsenic [weight %]	0.0
Ti	Titanium [weight %]	0.0
THEXP1	Coefficient of thermal expansion in austenite	25.1e-06 1/K [7]
THEXP5	Coefficient of thermal expansion in martensite	11.1e-06 1/K [7]
LCTH1	Load curve for the thermal expansion coefficient for austenite: LT.0.0: curve ID = -LA and TREF is used as reference temperature GT.0.0: curve ID = LA	0
LCTH5	Load curve for the thermal expansion coefficient for martensite: LT.0.0: curve ID = -LA and TREF is used as reference temperature GT.0.0: curve ID = LA	0
TREF	Reference temperature for thermal expansion. Used if and only if LA.LT.0.0 or/and LM.LT.0.0	293.15
LAT1	Latent heat for the decomposition of austenite into ferrite, pearlite and bainite.	590.e+06 J/m <sup>3</sup> [2]
LAT5	Latent heat for the decomposition of austenite into martensite	640.e+06 J/m <sup>3</sup> [2]
QR2	Activation energy divided by the universal gas constant for the diffusion reaction of the	11575. K [3] = (23000 cal/mole)*(4.184

VARIABLE	DESCRIPTION	BASELINE VALUE
	austenite-ferrite reaction: $Q2/R$ . $R = 8.314472$ [J/mol K].	J/cal) / (8.314 J/mole*K)
QR3	Activation energy divided by the universal gas constant for the diffusion reaction for the austenite-pearlite reaction: $Q3/R$ . $R=8.314472$ [J/mol K].	13840. K [3]
QR4	Activation energy divided by the universal gas constant for the diffusion reaction for the austenite-bainite reaction: $Q4/R$ . $R=8.314472$ [J/mol K].	13588. K [3]
ALPHA	Material constant for the martensite phase. A value of 0.011 means that 90% of the available austenite is transformed into martensite at 210 degrees below the martensite start temperature (see messag file for information), whereas a value of 0.033 means a 99.9% transformation.	0.011
GRAIN	ASTM grain size number for austenite, usually a number between 7 and 11.	8
TOFFE	Number of degrees that the ferrite is bleeding over into the pearlite reaction.	0.0
TOFPE	Number of degrees that the pearlite is bleeding over into the bainite reaction	0.0
TOFBA	Number of degrees that the bainite is bleeding over into the martenasite reaction.	0.0
PLMEM2	Memory coefficient for the plastic strain that is carried over from the austenite. A value of 1 means that all plastic strains from austenite is transferred to the <i>ferrite</i> phase and a value of 0 means that nothing is transferred.	0.0
PLMEM3	Same as PLMEM2 but between austenite and pearlite.	0.0
PLMEM4	Same as PLMEM2 but between austenite and bainite.	0.0
PLMEM5	Same as PLMEM3 but between austenite and martensite.	0.0

<b>VARIABLE</b>	<b>DESCRIPTION</b>	<b>BASELINE VALUE</b>
STRC	Effective strain rate parameter C. STRC.LT.0.0: load curve id = -STRC STRC.GT.0.0: constant value STRC.EQ.0.0: strain rate NOT active	0.0
STRP	Effective strain rate parameter P. STRP.LT.0.0: load curve id = -STRP STRP.GT.0.0: constant value STRP.EQ.0.0: strain rate NOT active	0.0
AUST	If starting a heating process from $t = 0$ this parameters sets the initial amount of austenite in the blank. If heating is activated at $t > 0$ during a simulation this value is ignored.	0.0
FERR	See AUST for description	0.0
PEAR	See AUST for description	0.0
BAIN	See AUST for description	0.0
MART	See AUST for description	0.0
GRK	Growth parameter k	[9]
GRQR	Grain growth activation energy divided by the universal gas constant. $Q/R$ where $R=8.314472$ (J/mol K)	[9]
TAU1	Empirical grain growth parameter $c_1$ describing the function $\tau(T)$	2.08E+8[9]
GRA	Grain growth parameter A	3.11[9]
GRB	Grain growth parameter B	7520.0[9]
EXPA	Grain growth parameter a	1.0[9]
EXPB	Grain growth parameter b	1.0[9]
GRCC	Grain growth parameter with the concentration of non metals in the blank	C+P[9]
GRCM	Grain growth parameter with the concentration of metals in the blank	B+Co+Mo+Cr+Ni+ Mn+Si+V+W+Cu+ Al+As+Ti[9]



<u>VARIABLE</u>	<u>DESCRIPTION</u>	<u>BASELINE VALUE</u>
HEATN	Grain growth parameter n for the austenite formation	1.0[9]
TAU2	Empirical grain growth parameter $c_2$ describing the function $\tau(T)$	4.806[9]

**Remarks:**

- History variables 1-8 include the different phases, the Vickers hardness, the yield stress and the ASTM grain size number. Set NEIPS = 8 (shells) or NEIPH = 8 (solids) on \*DATABASE\_EXTENT\_BINARY.

History variable	
1	Amount austenite
2	Amount ferrite
3	Amount pearlite
4	Amount bainite
5	Amount martensite
6	Vickers hardness
7	Yield stress
8	ASTM grain size number (a low value means large grains and vice versa)

- To exclude a phase from the simulation, set the PHASE parameter accordingly.
- Note that both strain rate parameters must be set to include the effect. It is possible to use a temperature dependent load curve for both parameters simultaneously or for one parameter keeping the other constant.
- TUNIT is time units per hour and is only used for calculating the Vicker Hardness, as default it is assumed that the time unit is seconds. If other time unit is used, for example milli seconds, then TUNIT must be changed to  $TUNIT = 3.6 \cdot 10^6$
- With the CRSH = 1 option it is now possible to transfer the material properties from a hot stamping simulation (CRSH = 0) into another simulation. The CRSH = 1 option reads a *dynain* file from a simulation with CRSH = 0 and keeps all the history variables (austenite, ferrite, pearlite, bainite, martensite, etc) constant. This will allow steels with inhomogeneous strength to be analysed in, for example, a crash simulation. The speed with the CRSH=1 option is comparable with \*MAT\_024.
- When HEAT is activated the re-austenitization and grain growth algorithms are activated. The grain growth is activated when the temperature exceeds a threshold value that is given by

$$T = \frac{B}{A - \ln(GRCM^a GRCC^b)}$$

and the rate equation for the grain growth is  $\dot{g} = \frac{k}{2g} e^{-\frac{Q}{RT}}$ . The rate equation for the phase re-austenitization is given in Oddy (1996) and is here mirrored

$$\dot{x}_a = n \left( \ln \left( \frac{x_{eu}}{x_{eu} - x_a} \right) \right)^{\frac{n-1}{n}} \left( \frac{x_{eu} - x_a}{\tau(T)} \right)$$

where n is the parameter HEATN. The temperature

dependent function  $\tau(T)$  is given from Oddy as  $\tau(T) = c_1 (T - T_s)^{c_2}$ . The empirical parameters  $c_1$  and  $c_2$  are calibrated in Oddy to 2.06E+8 and 4.806 respectively. Note that  $\tau$  is given in **seconds**.

## References

1. Numisheet 2008 Proceedings, The Numisheet 2008 Benchmark Study, Chapter 3, Benchmark 3, Continuous Press Hardening, Interlaken, Switzerland, Sept. 2008.
2. P. Akerstrom & M. Oldenburg, "Austenite Decomposition During Press hardening of a Boron Steel – Computer Simulation and Test", Journal of Material processing technology, 174 (2006), pp399-406.
3. D.F. Watt, "An Algorithm for Modelling Microstructural Development in Weld heat-Affected Zones (Part A) Reaction Kinetics", Acta metal. Vol. 36., No. 11, pp. 3029-3035, 1988.
4. ThyssenKrupp Steel, "Hot Press hardening Manganese-boron Steels MBW", product information Manganese-boron Steels, Sept. 2008.
5. Sjostrom & Akerstrom (1982)
6. Malek Naderi, "Hot Stamping of Ultra High Strength Steels", Doctor of Engineering Dissertation, Technical University Aachen, Germany, 2007.
7. P. Akerstrom, "Numerical Implementation of a Constitutive model for Simulation of Hot Stamping", Division of Solid Mechanics, Lulea University of technology, Sweden.
8. Malek Naderi, "A numerical and Experimental Investigation into Hot Stamping of Boron Alloyed Heat treated Steels", Steel research Int. 79 (2008) No. 2.
9. A.S. Oddy, J.M.J. McDill and L. Karlsson, "Microstructural predictions including arbitrary thermal histories, reaustenitization and carbon segregation effects" (1996).

**Boron steel composition from the literature.**

	HAZ code	Akerstrom (2)	Naderi (8)	ThyssenKrupp(4) (max amount)
B		0.003	0.003	0.005
C	0.168	0.23	0.230	0.250
Co				
Mo	0.036			0.250
Cr	0.255	0.211	0.160	0.250
Ni	0.015			
Mn	1.497	1.25	1.18	1.40
Si	0.473	0.29	0.220	0.400
V	0.026			
W				
Cu	0.025			
P	0.012	0.013	0.015	0.025
Al	0.020			
As				
Ti			0.040	0.05
S		0.003	0.001	0.010

**\*MAT\_PML\_{OPTION}TROPIC\_ELASTIC**

This is Material Type 245. This is a perfectly-matched layer (PML) material for orthotropic or anisotropic media, to be used in a wave-absorbing layer adjacent to an orthotropic/anisotropic material (\*MAT\_{OPTION}TROPIC\_ELASTIC) in order to simulate wave propagation in an unbounded ortho/anisotropic medium.

This material is a variant of MAT\_PML\_ELASTIC (MAT\_230) and is available only for solid 8-node bricks (element type 2). The input cards exactly follow \*MAT\_{OPTION}TROPIC\_ELASTIC as shown below. See the variable descriptions and Remarks section of \*MAT\_{OPTION}TROPIC\_ELASTIC (\*MAT\_002) for further details.

Available options include:

**ORTHO**

**ANISO**

such that the keyword cards appear:

**\*MAT\_PML\_ORTHOTROPIC\_ELASTIC or MAT\_245** (4 cards follow)

**\*MAT\_PML\_ANISOTROPIC\_ELASTIC or MAT\_245\_ANISO** (5 cards follow)

**Cards 1 and 2 for the ORTHO option.**

Card 1            1            2            3            4            5            6            7            8

Variable	MID	RO	EA	EB	EC	PRBA	PRCA	PRCB
Type	A8	F	F	F	F	F	F	F

Card 2            1            2            3            4            5            6            7            8

Variable	GAB	GBC	GCA	AOPT	G	SIGF		
Type	F	F	F	F	F	F		

**Cards 1, 2, and 3 for the ANISO option.**

Card 1            1            2            3            4            5            6            7            8

Variable	MID	RO	C11	C12	C22	C13	C23	C33
Type	A8	F	F	F	F	F	F	F

Card 2            1            2            3            4            5            6            7            8

Variable	C14	C24	C34	C44	C15	C25	C35	C45
Type	F	F	F	F	F	F	F	F

Card 3            1            2            3            4            5            6            7            8

Variable	C55	C16	C26	C36	C46	C56	C66	AOPT
Type	F	F	F	F	F	F	F	F

**Cards 3/4 and 4/5 for the ORTHO/ANISO options.**

Card 3/4        1            2            3            4            5            6            7            8

Variable	XP	YP	ZP	A1	A2	A3	MACF	
Type	F	F	F	F	F	F	I	

Card 4/5        1            2            3            4            5            6            7            8

Variable	V1	V2	V3	D1	D2	D3	BETA	REF
Type	F	F	F	F	F	F	F	F

**Remarks:**

8. A layer of this material may be placed at a boundary of a bounded domain to simulate unboundedness of the domain at that boundary: the layer absorbs and attenuates waves propagating outward from the domain, without any significant reflection of the waves back into the bounded domain. The layer cannot support any static displacement.
9. It is assumed the material in the bounded domain near the layer is, or behaves like, a linear ortho/anisotropic material. The material properties of the layer should be set to the corresponding properties of this material.
10. The layer should form a cuboid box around the bounded domain, with the axes of the box aligned with the coordinate axes. Various faces of this box may be open, as required by the geometry of the problem, e.g., for a half-space problem, the “top” of the box should be open.
11. Internally, LS-DYNA will partition the entire PML into regions which form the “faces”, “edges” and “corners” of the above cuboid box, and generate a new material for each region. This partitioning will be visible in the d3plot file. The user may safely ignore this partitioning.
12. The layer should have 5-10 elements through its depth. Typically, 5-6 elements are sufficient if the excitation source is reasonably distant from the layer, and 8-10 elements if it is close. The size of the elements should be similar to that of elements in the bounded domain near the layer, and should be small enough to sufficiently discretize all significant wavelengths in the problem.
13. The nodes on the outer boundary of the layer should be fully constrained.
14. The stress and strain values reported by this material do not have any physical significance.

\*MAT\_PML\_NULL

This is Material Type 246. This is a perfectly-matched layer (PML) material with a pressure fluid constitutive law computed using an equation of state, to be used in a wave-absorbing layer adjacent to a fluid material (\*MAT\_NULL with an EOS) in order to simulate wave propagation in an unbounded fluid medium. Only \*EOS\_LINEAR\_POLYNOMIAL and \*EOS\_GRUNEISEN are allowed with this material. See the Remarks section of \*MAT\_NULL (\*MAT\_009) for further details. Accurate results are to be expected only for the case where the EOS presents a linear relationship between the pressure and volumetric strain.

This material is a variant of MAT\_PML\_ELASTIC (MAT\_230) and is available only for solid 8-node bricks (element type 2).

Card            1            2            3            4            5            6            7            8

Variable	MID	RO	MU					
Type	A8	F	F					
Default	none	none	0.0					

<u>VARIABLE</u>	<u>DESCRIPTION</u>
MID	Material identification. A unique number or label not exceeding 8 characters must be specified.
RO	Mass density.
MU	Dynamic viscosity coefficient

**Remarks:**

15. A layer of this material may be placed at a boundary of a bounded domain to simulate unboundedness of the domain at that boundary: the layer absorbs and attenuates waves propagating outward from the domain, without any significant reflection of the waves back into the bounded domain. The layer cannot support any static displacement.
16. It is assumed the material in the bounded domain near the layer is, or behaves like, an linear fluid material. The material properties of the layer should be set to the corresponding properties of this material.

17. The layer should form a cuboid box around the bounded domain, with the axes of the box aligned with the coordinate axes. Various faces of this box may be open, as required by the geometry of the problem, e.g., for a half-space problem, the “top” of the box should be open.
18. Internally, LS-DYNA will partition the entire PML into regions which form the “faces”, “edges” and “corners” of the above cuboid box, and generate a new material for each region. This partitioning will be visible in the d3plot file. The user may safely ignore this partitioning.
19. The layer should have 5-10 elements through its depth. Typically, 5-6 elements are sufficient if the excitation source is reasonably distant from the layer, and 8-10 elements if it is close. The size of the elements should be similar to that of elements in the bounded domain near the layer, and should be small enough to sufficiently discretize all significant wavelengths in the problem.
20. The nodes on the outer boundary of the layer should be fully constrained.
21. The stress and strain values reported by this material do not have any physical significance.



\* MAT\_PIECEWISE\_LINEAR\_PLASTIC\_THERMAL

This is material type 255, an isotropic elastoplastic material with thermal properties. It can be used for both explicit and implicit analyses. Young’s modulus and Poisson’s ratio can depend on the temperature by defining two load curves. Moreover, the yield stress in tension and compression are given as load curves for different temperatures by using two tables. The thermal coefficient of expansion can be given as a constant ALPHA or as a load curve, see LALPHA at position 3 on card 2. A positive curve ID for LALPHA models the instantaneous thermal coefficient, whereas a negatives curve ID models the thermal coefficient relative to a reference temperature, TREF. The strain rate effects are modelled with the Cowper-Symonds rate model with the parameters C and P on card 1. Failure can be based on effective plastic strain or using the \*MAT\_ADD\_EROSION keyword.

Card 1            1            2            3            4            5            6            7            8

Variable	MID	RO	E	PR	C	P	FAIL	TDEL
Type	A8	F	F	F	F	F	F	F

Card 2            1            2            3            4            5            6            7            8

Variable	TABIDC	TABIDT	LALPHA					
Type	I	I	I					

Card 3            1            2            3            4            5            6            7            8

Variable	ALPHA	TREF						
Type	F	F						

<u>VARIABLE</u>	<u>DESCRIPTION</u>
MID	Material identification. A unique number or label not exceeding 8 characters must be specified.
RO	Mass density.

VARIABLE	DESCRIPTION
E	Young's modulus: LT.0.0:  E  is the LCID for E versus temperature, GT.0.0: E is constant.
PR	Poisson's ratio. LT.0.0:  PR  is the LCID for Poisson's ratio versus temperature. GT.0.0: PR is constant
C	Strain rate parameter. See remark 1.
P	Strain rate parameter. See remark 1.
FAIL	Effective plastic strain when the material fails. User defined failure subroutine, matusr_24 in dyn21.F, is called to determine failure when FAIL<0. Note that for solids the *MAT_ADD_EROSION can be used for additional failure criteria.
TDEL	A time step less then TDEL is not allowed. A step size less than TDEL trigger automatic element deletion. This option is ignored for implicit analyses.
TABIDC	Table ID for yield stress in compression, see remark 2.
TABIDT	Table ID for yield stress in tension, see remark 2.
LALPHA	Load curve ID for thermal expansion coefficient as a function of temperature. GT.0.0: the instantaneous thermal expansion coefficient based on the following formula: $d\varepsilon_{ij}^{thermal} = \alpha(T)dT\delta_{ij}$ LT.0.0: the thermal coefficient is defined relative a reference temperature TREF, such that the total thermal strain is given by: $\varepsilon_{ij}^{thermal} = \alpha(T)(T - T_{ref})\delta_{ij}$ With this option active, ALPHA is ignored.
ALPHA	Coefficient of thermal expansion
TREF	Reference temperature, which is required if and only if LALPHA is given with a negative load curve ID.

**Remarks:**

- The strain rate effect is modelled by using the Cowper and Symonds model which scales the yield stress according to the factor

$$1 + \left( \frac{\dot{\epsilon}}{C} \right)^{1/P}$$

where  $\dot{\epsilon} = \sqrt{\dot{\epsilon}_{ij}\dot{\epsilon}_{ij}}$  is the Euclidean norm of the total strain rate tensor.

2. The yield stresses versus effective plastic strains are given in two tables. One table for yield stresses in compression and another table for yield stresses in tension. The table indices consist of temperatures and at each temperature an unique yield stress curve must be defined. If the same yield stress should be used in both tension and compression, only one table needs to be defined and the same TABID is put in position 1 and 2 on card 2.
3. Two history variables are added to the d3plot file, the Young's modulus and the Poisson's ratio, respectively. They can be requested through the \*DATABASE\_EXTENT\_BINARY keyword.
4. Nodal temperatures must be defined by using a coupled analysis or some other way to define the temperatures, such as \*LOAD\_THERMAL\_VARIABLE or \*LOAD\_THERMAL\_LOAD\_CURVE.

**\*MAT\_AMORPHOUS\_SOLIDS\_FINITE\_STRAIN**

This is material type 256, an isotropic elastic-viscoplastic material model intended to describe the behaviour of amorphous solids such as polymeric glasses. The model accurately captures the hardening-softening-hardening sequence and the Bauschinger effect experimentally observed at tensile loading and unloading respectively. The formulation is based on hyperelasticity and uses the multiplicative split of the deformation gradient  $F$  which makes it naturally suitable for both large rotations and large strains. Stress computations are performed in an intermediate configuration and are therefore preceded by a pull-back and followed by a push-forward. The model was originally developed by Anand and Gurtin [2003] and implemented for solid elements by Bonnaud and Faleskog [2008]

Card 1            1            2            3            4            5            6            7            8

Variable	MID	RO	K	G	MR	LL	NU0	M
Type	A8	F	F	F	F	F	F	F

Card 2            1            2            3            4            5            6            7            8

Variable	ALPHA	H0	SCV	B	ECV	G0	S0	
Type	F	F	F	F	F	F	F	

<u>VARIABLE</u>	<u>DESCRIPTION</u>
MID	Material identification. A unique number or label not exceeding 8 characters must be specified.
RO	Mass density
K	Bulk modulus
G	Shear modulus
MR	Kinematic hardening parameter: $\mu_R$ (see Eq.1)
LL	Kinematic hardening parameter: $\lambda_L$ (see Eq.1)
NU0	Creep parameter: $\nu_0$ (see Eq.2)
M	Creep parameter: $m$ (see Eq.2)

VARIABLE	DESCRIPTION
ALPHA	Creep parameter: $\alpha$ (see Eq.2)
H0	Isotropic hardening parameter: $h_0$ (see Eq.3-5)
SCV	Isotropic hardening parameter: $s_{cv}$ (see Eq.3-5)
B	Isotropic hardening parameter: $b$ (see Eq.3-5)
ECV	Isotropic hardening parameter: $\eta_{cv}$ (see Eq.3-5)
G0	Isotropic hardening parameter: $g_0$ (see Eq.3-5)
S0	Isotropic hardening parameter: $s_0$ (see Eq.3-5)

**Remarks:**

1) Kinematic hardening gives rise to the second hardening occurrence in the hardening-softening-hardening sequence. The constants  $\mu_R$  and  $\lambda_L$  enter the back stress  $\mu B$  (where  $B$  is the left Cauchy-Green deformation tensor) through the function  $\mu$  according to:

$$\mu = \mu_R \left( \frac{\lambda_L}{3\lambda^p} \right) L^{-1} \left( \frac{\lambda^p}{\lambda_L} \right) \text{ Eq.1}$$

where  $\lambda^p = \frac{1}{\sqrt{3}} \sqrt{\text{tr}(B^p)}$ ,  $B^p$  is the plastic part of the left Cauchy-Green deformation tensor and where  $L$  is the Langevin function defined by  $L(X) = \coth(X) - X^{-1}$

2) This material model assumes plastic incompressibility. Nevertheless in order to account for the different behaviours in tension and compression a Drucker-Prager law is included in the creep law according to:

$$\nu^p = \nu_0 \left( \frac{\bar{\tau}}{s + \alpha\pi} \right)^{1/m} \text{ Eq.2}$$

where  $\nu^p$  is the equivalent plastic shear strain rate,  $\bar{\tau}$  the equivalent shear stress,  $s$  the internal variable defined below and  $-\pi$  the hydrostatic stress.

3) Isotropic hardening gives rise to the first hardening occurrence in the hardening-softening-hardening sequence. Two coupled internal variables are defined:  $s$  the resistance to plastic flow and  $\eta$  the local free volume. Their evolution equations read:

$$\dot{s} = h_0 \left( 1 - \frac{s}{\tilde{s}(\eta)} \right) \nu^p \text{ Eq.3}$$

$$\dot{\eta} = g_0 \left( \frac{s}{s_{cv}} - 1 \right) \nu^p \text{ Eq.4}$$

$$\tilde{s}(\eta) = s_{cv} [1 + b(\eta_{cv} - \eta)] \text{ Eq.5}$$

4) Typical material parameters values are given in Ref.1 for Polycarbonate:

G (GPa)	K (GPa)	MR (MPa)	LL (-)	NU0 (s <sup>-1</sup> )	M (-)
0.857	2.24	11.0	1.45	0.0017	0.011

ALPHA (-)	H0 (GPa)	SCV (MPa)	B (-)	ECV (-)	G0 (-)	S0 (MPa)
0.08	2.75	24.0	825	0.001	0.006	20.0

[1] Anand, L., Gurtin, M.E., 2003, "A theory of amorphous solids undergoing large deformations, with application to polymeric glasses," *International Journal of Solids and Structures*, 40, pp. 1465-1487.

\*MAT\_TISSUE\_DISPERSSED

This is Material Type 266. This material is an invariant formulation for dispersed orthotropy in soft tissues, e.g., heart valves, arterial walls or other tissues where one or two collagen fibers are used. The passive contribution is composed of an isotropic and two anisotropic parts. The isotropic part is a simple neo-Hookean model. The first anisotropic part is passive, with two collagen fibers to choose from: (1) a simple exponential model and (2) a more advanced crimped fiber model from Freed et al. [2005]. The second anisotropic part is active described in Guccione et al. [1993] and is used for active contraction.

Card 1            1            2            3            4            5            6            7            8

Variable	MID	RO	F	SIGMA	MU	KAPPA	ACT	INIT
Type	I	F	F	F	F	F	I	I

Card 2            1            2            3            4            5            6            7            8

Variable	FID	ORTH	C1	C2	C3	THETA		
Type	I	I	F	F	F	F		

Card 3            1            2            3            4            5            6            7            8

Variable	ACT1	ACT2	ACT3	ACT4	ACT5	ACT6	ACT7	ACT8
Type	F	F	F	F	F	F	F	F

Card 4            1            2            3            4            5            6            7            8

Variable	ACT9							
Type	F							

Card 5            1            2            3            4            5            6            7            8

Variable	AOPT	BETA	XP	YP	ZP	A1	A2	A3
Type	I	F	F	F	F	F	F	F

Card 6            1            2            3            4            5            6            7            8

Variable	V1	V2	V3	D1	D2	D3		
Type	F	F	F	F	F	F		

<u>VARIABLE</u>	<u>DESCRIPTION</u>
MID	Material identification. A unique number must be specified.
RO	Mass density.
F	Fiber dispersion parameter governs the extent to which the fiber dispersion extends to the third dimension. $F = 0$ and $F = 1$ apply to 2D splay with the normal to the membrane being in the $\beta$ and the $\gamma$ directions, respectively (see Figure 266.1). $F = 0.5$ applies to 3D splay with transverse isotropy. Splay will be orthotropic whenever $F \neq 0.5$ . This parameter is ignored if $INIT = 1$ .
SIGMA	The parameter SIGMA governs the extent of dispersion, such that as SIGMA goes to zero, the material symmetry reduces to pure transverse isotropy. Conversely, as SIGMA becomes large, the material symmetry becomes isotropic in the plane. This parameter is ignored if $INIT = 1$ .
MU	MU is the isotropic shear modulus that models elastin. MU should be chosen such that the quotient $0.5(3KAPPA - 2MU)/(3KAPPA + MU) < 0.5$ . Instability can occur for implicit simulations if this quotient is close to 0.5. A modest approach is a quotient between 0.495 and 0.497.
KAPPA	Bulk modulus for the hydrostatic pressure.
ACT	ACT = 1 indicates that an active model will be used that acts in the mean fiber-direction. The active model, like the passive model, will be dispersed by SIGMA and F, or if $INIT = 1$ , with the *INITIAL_FIELD_SOLID keyword.



<b>VARIABLE</b>	<b>DESCRIPTION</b>
INIT	INIT = 1 indicates that the anisotropy eigenvalues will be given by *INITIAL_FIELD_SOLID variables in the global coordinate system (see Remark 1).
FID	The passive fiber model number. There are two passive models available: FID = 1 or FID = 2. They are described in Remark 2.
ORTH	ORTH specifies the number (1 or 2) of fibers used. When ORTH = 2 two fiber families are used and arranged symmetrically THETA degrees from the mean fiber direction and lying in the tissue plane.
C1-C3	Passive fiber model parameters.
THETA	The angle between the mean fiber direction and the fiber families. The parameter is active only if ORTH = 2 and is particularly important in vascular tissues (e.g. arteries)
ACT1-ACT9	Active fiber model parameters.
AOPT	Material axes option (see MAT_OPTION TROPIC_ELASTIC for a more complete description): EQ.0.0: locally orthotropic with material axes determined by element nodes 1, 2, and 4, as with *DEFINE_COORDINATE_NODES. EQ.2.0: globally orthotropic with material axes determined by vectors defined below, as with *DEFINE_COORDINATE_VECTOR. EQ.3.0: locally orthotropic material axes determined by rotating the material axes about the element normal by an angle, BETA, from a line in the plane of the element defined by the cross product of the vector v with the element normal. LT.0.0: the absolute value of AOPT is a coordinate system ID number (CID on *DEFINE_COORDINATE_NODES, *DEFINE_COORDINATE_SYSTEM or *DEFINE_COORDINATE_VECTOR). Available with the R3 release of Version 971 and later.
BETA	Material angle in degrees for AOPT = 3, may be overridden on the element card *ELEMANT_SOLID_ORTHO.
P1-P3	P1, P2 and P3 define the coordinates of point P for AOPT=1 and AOPT = 4.
A1-A3	A1, A2 and A3 define the components of vector A for AOPT = 2.
D1-D3	D1, D2 and D3 define components of vector D for AOPT = 2.

VARIABLE	DESCRIPTION
V1-V3	V1, V2 and V3 define components of vector V for AOPT = 3 and AOPT = 4.

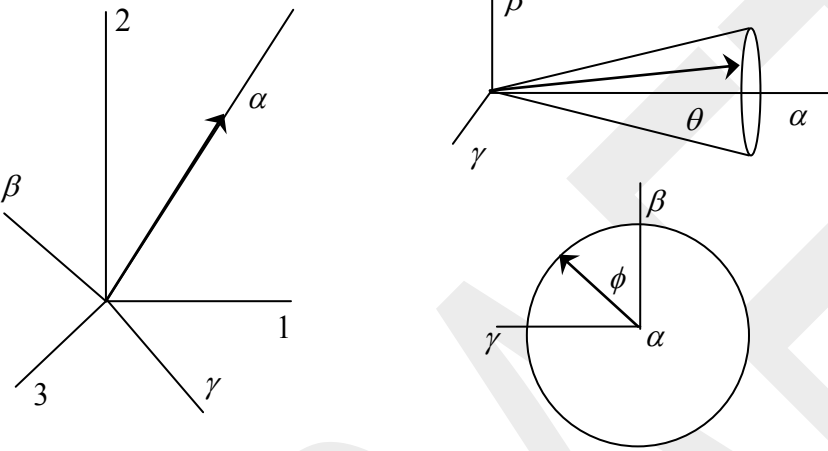

**Figure 266.1.** The plot on the left relates the global coordinates (1, 2, 3) to the local coordinates( $\alpha, \beta, \gamma$ ), selected so the mean fiber direction in the reference configuration is align with the  $\alpha$ -axis. The plots on the right show how the unit vector for a specific fiber within the fiber distribution of a 3D tissue is oriented with respect to the mean fiber direction via angles  $\theta$  and  $\phi$ .

Details of the passive model can be found in Freed et al. (2005) and Einstein et al. (2005). The stress in the reference configuration consists of a deviatoric matrix term, a hydrostatic pressure term, and either one (ORTHO = 1) or two (ORTH = 2) fiber terms:

$$\mathbf{S} = \kappa J(J - 1)\mathbf{C}^{-1} + \mu J^{-2/3} \mathbf{DEV} \left[ \frac{1}{4}(\mathbf{I} - \bar{\mathbf{C}}^{-2}) \right] + J^{-2/3} \sum_{i=1}^n [\sigma_i(\lambda_i) + \varepsilon_i(\lambda_i)] \mathbf{DEV}[\mathbf{K}_i]$$

where  $\mathbf{S}$  is the second Piola-Kirchhoff stress tensor,  $J$  is the Jacobian of the deformation gradient,  $\kappa$  is the bulk modulus,  $\sigma_i$  is the passive fiber stress model used, and  $\varepsilon_i$  is the corresponding active fiber model used. The operator  $\mathbf{DEV}$  is the deviatoric projection:

$$\mathbf{DEV}[\bullet] = (\bullet) - \frac{1}{3} \text{tr}[(\bullet)\mathbf{C}] \mathbf{C}^{-1}$$

where  $\mathbf{C}$  is the right Cauchy-Green deformation tensor. The dispersed fourth invariant  $\lambda = \sqrt{\text{tr}[\mathbf{K}\bar{\mathbf{C}}]}$ , where  $\bar{\mathbf{C}}$  is the isochoric part of the Cauchy-Green deformation. Note that  $\lambda$  is not a stretch in the classical way, since  $\mathbf{K}$  embeds the concept of dispersion.  $\mathbf{K}$  is called the dispersion tensor or anisotropy tensor and is given in global coordinates. The passive and active fiber models are defined in the fiber coordinate system. In effect the dispersion tensor rotates and weights these one dimensional models, such that they are both three-dimensional and in the Cartesian framework.

In the case where, the splay parameters SIGMA and F are specified,  $\mathbf{K}$  is given by:

$$\mathbf{K}_i = \frac{1}{2} \mathbf{Q}_i \begin{pmatrix} 1 + e^{-2\text{SIGMA}^2} & 0 & 0 \\ 0 & F(1 - e^{-2\text{SIGMA}^2}) & 0 \\ 0 & 0 & (1-F)(1 - e^{-2\text{SIGMA}^2}) \end{pmatrix} \mathbf{Q}_i^T$$

where  $\mathbf{Q}$  is the transformation tensor that rotates from the local to the global Cartesian system. In the case when INIT = 1, the dispersion tensor is given by

$$\mathbf{K}_i = \mathbf{Q}_i \begin{pmatrix} \chi_i^1 & 0 & 0 \\ 0 & \chi_i^2 & 0 \\ 0 & 0 & \chi_i^3 \end{pmatrix} \mathbf{Q}_i^T$$

where the  $\chi$ :s are given on the \*INITIAL\_FIELD\_SOLID card. For the values to be physically meaningful  $\chi_i^1 + \chi_i^2 + \chi_i^3 = 1$ . It is the responsibility of the user to assure that this condition is met, no internal checking for this is done. These values typically come from diffusion tensor data taken from the myocardium.

### **Remarks:**

1. Passive fiber models. Currently there are two models available.

(a) If FID = 1 a crimped fiber model is used. It is solely developed for collagen fibers. Given  $H_0$  and  $R_0$  compute:

$$L_0 = \sqrt{(2\pi)^2 + (H_0)^2}, \quad \Lambda = \frac{L_0}{H_0}$$

and

$$E_s = \frac{E_f H_0}{H_0 + \left(1 + \frac{37}{6\pi^2} + 2\frac{L_0^2}{\pi^2}\right)(L_0 - H_0)}.$$

Now if the fiber stretches  $\lambda < \Lambda$  the fiber stress is given by:

$$\sigma = \xi E_s (\lambda - 1)$$

where

$$\xi = \frac{6\pi^2 (\Lambda^2 + (4\pi^2 - 1)\lambda^2)\lambda}{\Lambda (3H_0^2 (\Lambda^2 - \lambda^2)(3\Lambda^2 + (8\pi^2 - 3)\lambda^2) + 8\pi^2 (10\Lambda^2 + (3\pi^2 - 10)\lambda^2))}$$

and if  $\lambda > \Lambda$  the fiber stress equals:

$$\sigma = E_s (\lambda - 1) + E_f (\lambda - \Lambda).$$

In Figure 266.1 the fiber stress is rendered with  $H0 = 27.5$ ,  $R0 = 2$  and the transition point becomes  $\Lambda = 1.1$ .

(b) The second fiber model available (FID = 2) is a simpler but more useful model for the general fiber reinforced rubber. The fiber stress is simply given by:

$$\sigma = C_1 \left( e^{\frac{C_2}{2}(\lambda^2 - 1)} - 1 \right).$$

The difference between the two fiber models is given in Figure 266.2.

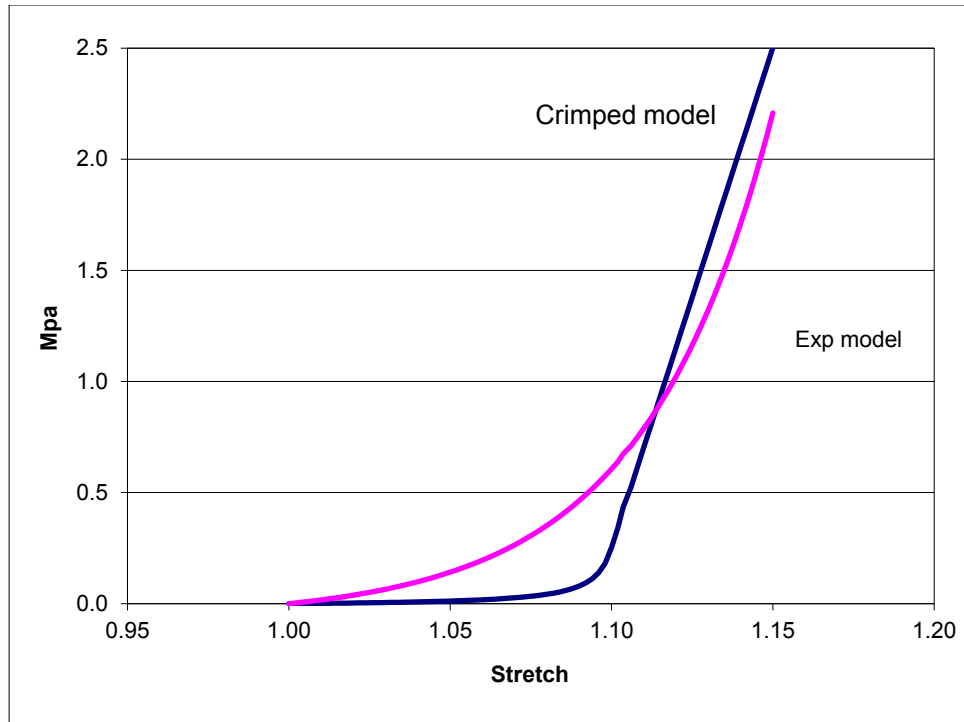

**Figure 266.2.** Both the Crimped and the Exponential fiber models visualized. Here  $\Lambda = 1.1$  is the transition point in the crimped model.

- The active model for myofibers (ACT=1) is defined in Guccione et al. (1993) and is given by:

$$\sigma = T_{\max} \frac{Ca_0^2}{Ca_0^2 + ECa_{50}^2} C(t)$$

where

$$ECa_{50}^2 = \frac{(Ca_0)_{\max}}{\sqrt{e^{B(l_r \sqrt{2(\lambda-1)+1}-l_0)-1}}}}$$

and  $B$  is a constant,  $(Ca_0)_{\max}$  is the maximum peak intracellular calcium concentration,  $l_0$  is the sarcomere length at which no active tension develops and  $l_r$  is the stress free sarcomere length. The function  $C(t)$  is defined as:

$$C(t) = \frac{1}{2}(1 - \cos \omega(t))$$

where

$$\omega = \begin{cases} \pi \frac{t}{t_0} & 0 \leq t < t_0 \\ \pi \frac{t - t_0 + t_r}{t_r} & t_0 \leq t < t_0 + t_r \\ 0 & t_0 + t_r \leq t \end{cases}$$

and  $t_r = ml_R \lambda + b$ . The active parameters on Card 3 and 4 are interpreted as:

ACT1	ACT2	ACT3	ACT4	ACT5	ACT6	ACT7	ACT8	ACT9
$T_{\max}$	$Ca_0$	$(Ca_0)_{\max}$	$B$	$l_0$	$t_0$	$m$	$b$	$l_R$

**References:**

- Freed AD., Einstein DR. and Vesely I., Invariant formulation for dispersed transverse isotropy in aortic heart valves – An efficient means for modeling fiber splay, Biomechanical Model Mechanobiol, 4, 100-117, 2005.
- Guccione JM., Waldman LK., McCulloch AD., Mechanics of Active Contraction in Cardiac Muscle: Part II – Cylindrical Models of the Systolic Left Ventricle, J. Bio Mech, 115, 82-90, 1993.

\*MAT\_EIGHT\_CHAIN\_RUBBER

This is Material Type 267. This is an advanced rubber-like model that is tailored for glassy polymers and similar materials. It is based on Arruda’s eight chain model but enhanced with non elastic properties.

Card 1            1            2            3            4            5            6            7            8

Variable	MID	RO	K	MU	N	MULL	VISPL	VISEL
Type	I	F	F	F	I	I	I	I
Default	None	None	0.0	0.0	0	0	0	0

Card 2            1            2            3            4            5            6            7            8

Variable	YLD0	FP	GP	HP	LP	MP	NP	PMU
Type	F	F	F	F	F	F	F	F
Default	0.0	0.0	0.0	0.0	0.0	0.0	0.0	0.0

Card 3            1            2            3            4            5            6            7            8

Variable	M1	M2	M3	M4	M5	TIME	VCON	
Type	F	F	F	F	F	F	F	
Default	See MULL	See MULL	See MULL	See MULL	See MULL	0.0	9.0	

Card 4            1            2            3            4            5            6            7            8

Variable	Q1	B1	Q2	B2	Q3	B3	Q4	B4
Type	F	F	F	F	F	F	F	F
Default	0.0	0.0	0.0	0.0	0.0	0.0	0.0	0.0

Card 5            1            2            3            4            5            6            7            8

Variable	K1	S1	K2	S2	K3	S3		
Type	F	F	F	F	F	F		
Default	0.0	0.0	0.0	0.0	0.0	0.0		

Card 6            1            2            3            4            5            6            7            8

Variable	AOPT	MACF	XP	YP	ZP	A1	A2	A3
Type	F	F	F	F	F	F	F	F
Default	0.0	0.0	0.0	0.0	0.0	0.0	0.0	.0.0

Card 7            1            2            3            4            5            6            7            8

Variable	V1	V2	V3	D1	D2	D3	THETA	
Type	F	F	F	F	F	F	F	
Default	0.0	0.0	0.0	0.0	0.0	0.0	0.0	



Card 8-14      1            2            3            4            5            6            7            8

Variable	TAUi	BETAi						
Type	F	F						
Default	0.0	0.0						

<u>VARIABLE</u>	<u>DESCRIPTION</u>
MID	Material identification. A unique number must be specified
RO	Mass density.
K	Bulk modulus. To get almost incompressible behavior set this to one or two orders of magnitude higher than MU. Note that the Poisson's ratio should be kept at a realistic value. $\nu = \frac{3K - 2MU}{2(3K + MU)}$ .
MU	Shear modulus. MU is the product of the number of molecular chains per unit volume (n), Boltzmann's constant (k) and the absolute temperature (T). Thus MU=nkT.
MULL	Parameter describing which softening algorithm that shall be used. EQ.1: Strain based Mullins effect from Qi and Boyce, see theory section below for details M1 = A (Qi recommends 3.5) M2 = B (Qi recommends 18.0) M3 = Z (Qi recommends 0.7) M4 = vs (between 0 and 1 and less than vss) M5 = vss (between 0 and 1 and greater than vs) EQ.2: Energy based Mullins, a modified version of Roxburgh and Ogden model. M1 > 0, M2 > 0 and M3 > 0 must be set. See Theory section for details.
VISPL	Parameter describing which viscoplastic formulation that should be used, see the theory section for details. EQ.0: No viscoplasticity. EQ.1: 2 parameters standard model, K1 and S1 must be set. EQ.2: 6 parameters G'Sells model, K1,K2,K3,S1,S2 and S3 must be set. EQ.3: 4 parameters Strain hardening model, K1,K2,S1,S2 must be set.

<u>VARIABLE</u>	<u>DESCRIPTION</u>
VISEL	Option for viscoelastic behavior, see the theory section for details. EQ.0: No viscoelasticity. EQ.1: Free energy formulation based on Holzapfel and Ogden. EQ.2: Formulation based on stiffness ratios from Simo et al.
YLD0	Initial yield stress. EQ.0.0: No plasticity GT.0.0: Initial yield stress. Hardening is defined seperately. LT.0.0: -YLD0 is taken as the load curve ID for the yield stress versus effective plastic strain.
FP-NP	Parameters for Hill's general yield surface. For von mises yield criteria set FP=GP=HP=0.5 and LP=MP=NP=1.5.
PMU	Kinematic hardening parameter. It is usually equal to MU.
M1-M5	Mullins parameters MULL.EQ.1: M1-M5 are used MULL.EQ.2: M1-M3 are used.
TIME	A time filter that is used to smoothen out the time derivate of the strain invariant over a TIME interval. Default is no smoothening but a value 100*TIMESTEP is recommended.
VCON	A material constant for the volumetric part of the strain energy. Default 9.0 but any value can be used to tailor the volumetric response. For example -2.
Q1-B4	Voce hardening parameters
K1-S3	Viscoplastic parameters. VISPL.EQ.1: K1 and S1 are used. VISPL.EQ.2: K1, S1, K2, S2, K3 and S3 are used. VISPL.EQ.3: K1, S1 and K2 are used.

VARIABLE	DESCRIPTION
AOPT	Material axes option (see *MAT_OPTORTROPIC_ELASTIC, *MAT_002) for a more complete description. EQ.0.0: Locally orthotropic with material axes defined by element nodes 1, 2 and 4. EQ.1.0: Locally orthotropic with material axes determined by a point in space and the global location of the element center; this is the a-direction. EQ.2.0: Globally orthotropic with material axes determined by vectors defined below. EQ.3.0: Locally orthotropic material axes determined by rotating the material axes about the element normal by angle THETA. The angle is defined from the line in the plane that is defined by the cross product of the vector $\mathbf{v}$ with the element normal. The plane of a solid is defined as the midsurface between the inner surface and the outer surface defined by the first 4 nodes and last 4 nodes. EQ.4.0: Locally orthotropic in cylindrical coordinate system with the material axes determined by a vector $\mathbf{v}$ and an originating point P.
MACF	Material axes change flag EQ.1.0: No change (default) EQ.2.0: Switch axes a and b EQ.3.0: Switch axes a and c EQ.4.0: Switch axes b and c
XP,YP,ZP	Define coordinates for point P for AOPT = 1 and 4
A1,A2,A3	Define components of vector $\mathbf{a}$ for AOPT = 2.
D1,D2,D3	Define components of vector $\mathbf{d}$ for AOPT = 2
V1,V2,V3	Define components of vector $\mathbf{v}$ for AOPT = 3 and 4
TAUi	Relaxation time. A maximum of 6 values can be used.
BETAi/ GAMMAi	VISEL.EQ.1: Dissipating energy factors.(see Holzapfel) VISEL.EQ.2: Gamma factors (see Simo)

### **Basic theory**

This model is based on the work done by Arruda and Boyce [1993], in particular Arruda's thesis [1992]. The eight chain rubber model is based on hyper elasticity and it is formulated by using strain invariants. The strain softening is taken from work done by Qi and Boyce [2004], where the strain energy used is defined as

$$\Psi = v_s \mu \left[ \sqrt{N} \Lambda_c \beta + N \ln \left( \frac{\beta}{\sinh \beta} \right) \right] + \Psi_2 = \Psi_1 + \Psi_2,$$

where the amplified chain stretch is given by  $\Lambda_c = \sqrt{X(\bar{\lambda}^2 - 1) + 1}$  and

$$\beta = L^{-1} \left( \frac{\Lambda_c}{\sqrt{N}} \right),$$

where  $\bar{\lambda}^2 = I_1/3$ ,  $\mu$  is the initial modulus of the soft domain,  $N$  is the number of rigid links between crosslinks of the soft domain region.  $X = 1 + A(1 - v_s) + B(1 - v_s)^2$ , is a general polynomial describing the interaction between the soft and the hard phases (Qi and Boyce [2004] and Tobin and Mullins [1957]). The compressible behavior is described by the strain energy.

$$\Psi_2 = \frac{1}{v_{con}} \left( v_{con} \ln J + \frac{1}{J^{v_{con}}} - 1 \right)$$

Where  $J$  is the determinant of the elastic deformation gradient  $\mathbf{F}_e$ . The Cauchy stress is then computed as:

$$\boldsymbol{\sigma} = \frac{2}{J} \mathbf{F}_e \frac{\partial \Psi}{\partial \mathbf{C}_e} \mathbf{F}_e^T = \frac{1}{J} \mathbf{F}_e (\mathbf{S}_1 + \mathbf{S}_2) \mathbf{F}_e^T = \frac{v_s X \mu}{3J} \frac{\sqrt{N}}{\Lambda_c} L^{-1} \left( \frac{\Lambda_c}{\sqrt{N}} \right) \left( \mathbf{B}_e - \frac{1}{3} I_1 \mathbf{I} \right) + \frac{2K}{J^{v_{con}}} \left( 1 - \frac{1}{J^{v_{con}}} \right)$$

where  $\mathbf{S}_1$  and  $\mathbf{S}_2$  are second Piola-Kirchhoff stresses based on  $\Psi_1$  and  $\Psi_2$  respectively.

### Mullins effect

Two models for the Mullins effect are implemented.

MULL.EQ.1: The strain softening is developed by the evolution law taken from Boyce 2004:

$$\dot{v}_s = Z(v_{ss} - v_s) \frac{\sqrt{N} - 1}{(\sqrt{N} - \Lambda_c^{\max})^2} \dot{\Lambda}_c^{\max},$$

where  $Z$  is a parameter that characterizes the evolution in  $v_s$  with increasing  $\dot{\Lambda}_c^{\max}$ . The parameter  $v_{ss}$  is the saturation value of  $v_s$ . Note that  $\dot{\Lambda}_c^{\max}$  is the maximum of  $\dot{\Lambda}_c$  from the past:

$$\dot{\Lambda}_c^{\max} = \begin{cases} 0 & \Lambda_c < \Lambda_c^{\max} \\ \dot{\Lambda}_c & \Lambda_c > \Lambda_c^{\max} \end{cases}$$

The structure now evolves with the deformation. The dissipation inequality requires that the evolution of the structure is irreversible  $\dot{v}_s \geq 0$ . See Qi and Boyce [2004].

MULL.EQ.2: The energy driven model based on Ogden and Roxburgh. When activated the strain energy is automatically transformed to a standard eight chain model. That is, the variables Z, vs and X is automatically set to 0, 1 and 1 respectively. The stress is multiplicative split of the true stress and the softening factor  $\eta$ .

$$\bar{\sigma} = \eta\sigma, \quad \eta = 1 - \frac{1}{M1} \operatorname{erf} \left( \frac{\Psi_1^{\max} - \Psi_1}{M3 - M2\Psi_1^{\max}} \right).$$

### Viscoelasticity

VISEL=1: The viscoelasticity is based on work done by Holzapfel (2004)

$$\dot{\mathbf{Q}}_\alpha + \frac{\mathbf{Q}_\alpha}{\tau_\alpha} = 2\beta_\alpha \frac{d}{dt} \frac{\partial \Psi_1}{\partial \mathbf{C}_e} = \beta_\alpha \dot{\mathbf{S}}_1$$

where  $\alpha$  is the number of viscoelastic terms (0, 1, ..., 6).

VISEL=2 With this option the evolution is based on work done by Simo and Hughes (2000).

$$\dot{\mathbf{Q}}_\alpha + \frac{\mathbf{Q}_\alpha}{\tau_\alpha} = 2 \frac{\gamma_\alpha}{\tau_\alpha} \frac{d}{dt} \frac{\partial \Psi_1}{\partial \mathbf{C}_e} = \frac{\gamma_\alpha}{\tau_\alpha} \mathbf{S}_1$$

The the number of Prony terms is restricted to maximum 6 and  $\tau > 0, \gamma > 0$ .

The Cauchy stress is obtained by a push forward operation on the total second Piola-Kirchhoff stress.

$$\boldsymbol{\sigma} = \frac{1}{J} \mathbf{F}_e \mathbf{S} \mathbf{F}_e^T.$$

### Viscoplasticity

The plasticity is based on the general Hills' yield surface

$$\sigma_{eff}^2 = F(\sigma_{22} - \sigma_{33})^2 + G(\sigma_{33} - \sigma_{11})^2 + H(\sigma_{11} - \sigma_{22})^2 + 2L\sigma_{12}^2 + 2M\sigma_{23}^2 + 2N\sigma_{13}^2$$

and the hardening is either based on a load curve ID (-YLD0) or an extended Voce hardening

$$\sigma_{yld} = \sigma_{yld0} + Q_1(1 - e^{B_1\bar{\epsilon}}) + Q_2(1 - e^{B_2\bar{\epsilon}}) + Q_3(1 - e^{B_3\bar{\epsilon}}) + Q_4(1 - e^{B_4\bar{\epsilon}}).$$

The yield criterion is written

$$f = \sigma_{eff} - \sigma_{yld} \leq 0.$$

Adding the viscoplastic phenomena, we simply add one evolution equation for the effective plastic strain rate. Three different formulations is available.

- VISPL=1:

$$\dot{\epsilon}_{vp} = \left( \frac{f}{K_1} \right)^{S_1}$$

where  $K_1$  and  $S_1$  are viscoplastic material parameters.

- VISPL=2:

$$\dot{\epsilon}_{vp} = \left( \frac{f}{K_1 \left( 1 - e^{-S_1(\epsilon_{vp} + K_2)} \right) e^{S_2 \epsilon_{vp}^{K_3}}} \right)^{S_3}$$

Where  $K_1, K_2, K_3, S_1, S_2$  and  $S_3$  are viscoplastic parameters

- VISPL=3:

$$\dot{\epsilon}_{vp} = \left( \frac{f}{K_1} \right)^{S_1} (\epsilon_{vp} + K_2)^{S_2}$$

Where  $K_1, K_2, S_1$  and  $S_2$  are viscoplastic parameters.

**Kinematic hardening**

The back stress is calculated similar to the Cauchy stress above but without the softening factors:

$$\beta = \frac{\mu_p}{3J} \frac{\sqrt{N}}{\Lambda_c} L^{-1} \left( \frac{\Lambda_c}{\sqrt{N}} \right) \left( \mathbf{I} - \frac{1}{3} I_p \mathbf{C}_p^{-1} \right)$$

$\mu_p$  is a hardening material parameter (PMU). The total Piola-Kirchhoff stress is now given by  $\mathbf{S}^* = \mathbf{S} - \beta$  and the total stress is given by a standard push forward operation with the elastic deformation gradient.

**Remarks:**

- The parameter PMU is usually taken the same as MU.
- For the case of a dilute solution the Mullins parameter A should be equal to 3.5. See Qi and Boyce [2004].
- For a system with well dispersed particles B should somewhere around 18. See Qi and Boyce [2004].

**References:**

Qi HJ., Boyce MC., Constitutive model for stretch-induced softening of stress-stretch behavior of elastomeric materials, *Journal of the Mechanics and Physics of Solids*, 52, 2187-2205, 2004.

Arrude EM., Characterization of the strain hardening response of amorphous polymers, PhD Thesis, MIT, 1992.

Mullins L., Tobin NR., Theoretical model for the elastic behavior of filler reinforced vulcanized rubber, *Rubber Chem. Technol.*, 30, 555-571, 1957.

Ogden RW. Roxburgh DG., A pseudo-elastic model for the Mullins effect in Filled rubber., *Proc. R. Soc. Lond. A.*, 455, 2861-2877, 1999.

Simo JC., Hughes TJR., *Computational Inelasticity*, Springer, New York, 2000.

Holzappel GA., *Nonlinear Solid Mechanics*, Wiley, New-York, 2000.

**\*MAT\_RHT**

This is material type 272. This model is used to analyze concrete structures subjected to impulsive loadings, see Riedel et.al. (1999) and Riedel (2004).

Card 1	1	2	3	4	5	6	7	8
Variable	MID	RO	SHEAR	ONEMPA	EPSF	B0	B1	T1
Type	A8	F	F	F	F	F	F	F
Default	NONE	NONE	NONE	1.0	2.0	NONE	NONE	NONE

Card 2	1	2	3	4	5	6	7	8
Variable	A	N	FC	FS*	FT*	Q0	B	T2
Type	F	F	F	F	F	F	F	F
Default	NONE	NONE	NONE	NONE	NONE	NONE	NONE	NONE

Card 3	1	2	3	4	5	6	7	8
Variable	E0C	E0T	EC	ET	BETAC	BETAT	PTF	
Type	F	F	F	F	F	F	F	
Default	NONE	NONE	NONE	NONE	See remarks	See remarks	0.001	



Card 4      1            2            3            4            5            6            7            8

Variable	GC*	GT*	XI	D1	D2	EPM	AF	NF
Type	F	F	F	F	F	F	F	F
Default	NONE	NONE	NONE	NONE	NONE	NONE	NONE	NONE

Card 5      1            2            3            4            5            6            7            8

Variable	GAMMA	A1	A2	A3	PEL	PCO	NP	ALPHA0
Type	F	F	F	F	F	F	F	F
Default	NONE	NONE	NONE	NONE	NONE	NONE	NONE	NONE

**VARIABLE**

**DESCRIPTION**

MID	Material identification. A unique number or label not exceeding 8 characters must be specified.
RO	Mass density.
SHEAR	Elastic shear modulus
ONEMPA	Unit conversion factor defining 1 Mpa in the pressure units used. It can also be used for automatic generation of material parameters for a given compressive strength. (See remarks) EQ.0: Defaults to 1.0 EQ.-1: Parameters generated in m, s and kg (Pa) EQ.-2: Parameters generated in mm, s and tonne (MPa) EQ.-3: Parameters generated in mm, ms and kg (GPa) EQ.-4: Parameters generated in in, s and dozens of slugs (psi)
EPSF	Eroding plastic strain
B0	Parameter for polynomial EOS
B1	Parameter for polynomial EOS

<b>VARIABLE</b>	<b>DESCRIPTION</b>
T1	Parameter for polynomial EOS
A	Failure surface parameter A
N	Failure surface parameter N
FC	Compressive strength.
FS*	Relative shear strength
FT*	Relative tensile strength
Q0	Lode angle dependence factor
B	Lode angle dependence factor
T2	Parameter for polynomial EOS
E0C	Reference compressive strain rate
E0T	Reference tensile strain rate
EC	Break compressive strain rate
ET	Break tensile strain rate
BETAC	Compressive strain rate dependence exponent (optional)
BETAT	Tensile strain rate dependence exponent (optional)
PTF	Pressure influence on plastic flow in tension
GC*	Compressive yield surface parameter
GT*	Tensile yield surface parameter
XI	Shear modulus reduction factor
D1	Damage parameter
D2	Damage parameter
EPM	Minimum damaged residual strain
AF	Residual surface parameter
NF	Residual surface parameter

VARIABLE	DESCRIPTION
GAMMA	Gruneisen gamma
A1	Hugoniot polynomial coefficient
A2	Hugoniot polynomial coefficient
A3	Hugoniot polynomial coefficient
PEL	Crush pressure
PCO	Compaction pressure
NP	Porosity exponent
ALPHA	Initial porosity

### **Remarks:**

In the RHT model, the shear and pressure part is coupled in which the pressure is described by the Mie-Gruneisen form with a polynomial Hugoniot curve and a p- $\alpha$  compaction relation. For the compaction model, we define a history variable representing the porosity  $\alpha$  that is initialized to  $\alpha_0 > 1$ . This variable represents the current fraction of density between the matrix material and the porous concrete and will decrease with increasing pressure. The evolution of this variable is given as

$$\alpha(t) = \max \left( 1, \min \left( \alpha_0, \min_{s \leq t} \left( 1 + (\alpha_0 - 1) \left[ \frac{p_{comp} - p(s)}{p_{comp} - p_{el}} \right]^N \right) \right) \right)$$

where  $p(t)$  indicates the pressure at time  $t$ . This expression also involves the initial pore crush pressure  $p_{el}$ , compaction pressure  $p_{comp}$  and porosity exponent  $N$ . For later use, we define the cap pressure, or current pore crush pressure, as

$$p_c = p_{comp} - (p_{comp} - p_{el}) \left[ \frac{\alpha - 1}{\alpha_0 - 1} \right]^{1/N}$$

The remainder of the pressure (EOS) model is given in terms of the density and specific internal energy. Depending on user inputs, it is either governed by ( $B_0 > 0$ )

$$p(\rho, e) = \frac{1}{\alpha} \begin{cases} (B_0 + B_1 \eta) \alpha \rho e + A_1 \eta + A_2 \eta^2 + A_3 \eta^3 & \eta > 0 \\ B_0 \alpha \rho e + T_1 \eta + T_2 \eta^2 & \eta < 0 \end{cases}$$

or ( $B_0 = 0$ )

$$p(\rho, e) = \Gamma \rho e + \frac{1}{\alpha} p_H(\eta) \left[ 1 - \frac{1}{2} \Gamma \eta \right]$$

$$p_H(\eta) = A_1 \eta + A_2 \eta^2 + A_3 \eta^3$$

together with

$$\eta(\rho) = \frac{\alpha \rho}{\alpha_0 \rho_0} - 1.$$

For the shear strength description we use

$$p^* = p / f_c$$

as the pressure normalized with the compressive strength parameter. We also use  $\mathbf{s}$  to denote the deviatoric stress tensor and  $\dot{\varepsilon}_p$  the plastic strain rate.

For a given stress state and rate of loading, the elastic-plastic yield surface for the RHT model is given by

$$\sigma_y(p^*, \mathbf{s}, \dot{\varepsilon}_p, \varepsilon_p^*) = f_c \sigma_y^*(p^*, F_r(\dot{\varepsilon}_p, p^*), \varepsilon_p^*) R_3(\theta, p^*)$$

and is the composition of two functions and the compressive strength parameter  $f_c$ . The first describes the pressure dependence for principal stress conditions  $\sigma_1 < \sigma_2 = \sigma_3$  and is expressed in terms of a failure surface and normalized plastic strain as

$$\sigma_y^*(p^*, F_r, \varepsilon_p^*) = \sigma_f^* \left( \frac{p^*}{\gamma}, F_r \right) \gamma$$

with

$$\gamma = \varepsilon_p^* + (1 - \varepsilon_p^*) F_e F_c.$$

The failure surface is given as

$$\sigma_f^*(p^*, F_r) = \begin{cases} A(p^* - F_r/3 + (A/F_r)^{-1/n})^n & 3p^* \geq F_r \\ F_r f_s^* / Q_1 + 3p^* (1 - f_s^* / Q_1) & F_r > 3p^* \geq 0 \\ F_r f_s^* / Q_1 - 3p^* (1/Q_2 - \frac{f_s^*}{Q_1 f_t^*}) & 0 > 3p^* \geq 3p_t^* \\ 0 & 3p_t^* > 3p^* \end{cases}$$

in which  $p_t^* = \frac{F_r Q_2 f_s^* f_t^*}{3(Q_1 f_t^* - Q_2 f_s^*)}$  is the failure cut-off pressure,  $F_r$  is a dynamic increment factor and

$$Q_1 = R_3(\pi/6, 0) \quad Q_2 = Q(p^*)$$

In these expressions,  $f_t^*$  and  $f_s^*$  are the tensile and shear strength of the concrete relative to the compressive strength  $f_c$  and the  $Q$  values are introduced to account for the tensile and shear meridian dependence. Further details are given in the following.

To describe reduced strength on shear and tensile meridian the factor

$$R_3(\theta, p^*) = \frac{2(1-Q^2)\cos\theta + (2Q-1)\sqrt{4(1-Q^2)\cos^2\theta + 5Q^2 - 4Q}}{4(1-Q^2)\cos^2\theta + (1-2Q)^2}$$

is introduced, where  $\theta$  is the Lode angle given by the deviatoric stress tensor  $\mathbf{s}$  as

$$\cos 3\theta = \frac{27 \det(\mathbf{s})}{2\bar{\sigma}(\mathbf{s})^3} \quad \bar{\sigma}(\mathbf{s}) = \sqrt{\frac{3}{2} \mathbf{s} : \mathbf{s}}$$

The maximum reduction in strength is given as a function of relative pressure

$$Q = Q(p^*) = Q_0 + Bp^*$$

Finally, the strain rate dependence is given by

$$F_r(\dot{\epsilon}_p, p^*) = \begin{cases} F_r^c & 3p^* \geq F_r^c \\ F_r^c - \frac{3p^* - F_r^c}{F_r^c + F_r^t f_t^*} (F_r^t - F_r^c) & F_r^c > 3p^* \geq -F_r^t f_t^* \\ F_r^t & -F_r^t f_t^* > 3p^* \end{cases}$$

in which

$$F_r^{c/t}(\dot{\epsilon}_p) = \begin{cases} \left( \frac{\dot{\epsilon}_p}{\dot{\epsilon}_0^{c/t}} \right)^{\beta_{c/t}} & \dot{\epsilon}_p \leq \dot{\epsilon}_p^{c/t} \\ \gamma_{c/t} \sqrt[3]{\dot{\epsilon}_p} & \dot{\epsilon}_p > \dot{\epsilon}_p^{c/t} \end{cases}$$

The parameters involved in these expressions are given as ( $f_c$  is in MPa below)

$$\beta_c = \frac{4}{20 + 3f_c} \quad \beta_t = \frac{2}{20 + f_c}$$

and  $\gamma_{c/t}$  is determined from continuity requirements, but it is also possible to choose the rate parameters via inputs.

The elastic strength parameter used above is given by

$$F_e(p^*) = \begin{cases} g_c^* & 3p^* \geq F_r^c g_c^* \\ g_c^* - \frac{3p^* - F_r^c g_c^*}{F_r^c g_c^* + F_r^t g_t^* f_t^*} (g_t^* - g_c^*) & F_r^c g_c^* > 3p^* \geq -F_r^t g_t^* f_t^* \\ g_t^* & -F_r^t g_t^* f_t^* > 3p^* \end{cases}$$

while the cap of the yield surface is represented by

$$F_c(p^*) = \begin{cases} 0 & p^* \geq p_c^* \\ \sqrt{1 - \left( \frac{p^* - p_u^*}{p_c^* - p_u^*} \right)^2} & p_c^* > p^* \geq p_u^* \\ 1 & p_u^* > p^* \end{cases}$$

where

$$p_c^* = \frac{p_c}{f_c} \quad p_u^* = \frac{F_r^c g_c^*}{3} + \frac{G^* \epsilon_p}{f_c}$$

The hardening behavior is described linearly with respect to the plastic strain, where

$$\epsilon_p^* = \min\left(\frac{\epsilon_p}{\epsilon_p^h}, 1\right) \quad \epsilon_p^h = \frac{\sigma_y(p^*, \mathbf{s}, \dot{\epsilon}_p, \epsilon_p^*) (1 - F_e F_c)}{\gamma 3G^*}$$

Here

$$G^* = \xi G$$

where  $G$  is the shear modulus of the virgin material and  $\xi$  is a reduction factor representing the hardening in the model.

When hardening states reach the ultimate strength of the concrete on the failure surface, damage is accumulated during further inelastic loading controlled by plastic strain. To this end, the plastic strain at failure is given as

$$\varepsilon_p^f = \begin{cases} D_1 \left( p^* - (1-D)p_t^* \right)^{D_2} & p^* \geq (1-D)p_t^* + \left( \frac{\varepsilon_p^m}{D_1} \right)^{1/D_2} \\ \varepsilon_p^m & (1-D)p_t^* + \left( \frac{\varepsilon_p^m}{D_1} \right)^{1/D_2} > p^* \end{cases}$$

The damage parameter is accumulated with plastic strain according to

$$D = \int_{\varepsilon_p^h}^{\varepsilon_p} \frac{d\varepsilon_p}{\varepsilon_p^f}$$

and the resulting damage surface is given as

$$\sigma_d(p^*, \mathbf{s}, \dot{\varepsilon}_p) = \begin{cases} \sigma_y(p^*, \mathbf{s}, \dot{\varepsilon}_p, 1)(1-D) + Df_c \sigma_r^*(p^*) & p^* \geq 0 \\ \sigma_y(p^*, \mathbf{s}, \dot{\varepsilon}_p, 1)(1-D - \frac{p^*}{p_t^*}) & (1-D)p_t^* \leq p^* < 0 \end{cases}$$

where

$$\sigma_r^*(p^*) = A_f (p^*)^{n_f}$$

Plastic flow occurs in the direction of deviatoric stress, i.e.,

$$\dot{\varepsilon}_p \sim \mathbf{s}$$

but for tension there is an option to set the parameter PFC to a number corresponding to the influence of plastic volumetric strain. If  $\lambda \leq 1$  is used to denote this parameter, then for the special case of  $\lambda = 1$

$$\dot{\varepsilon}_p \sim \mathbf{s} - p\mathbf{I}$$

This was introduced to reduce noise in tension that was observed on some test problems. A failure strain can be used to erode elements with severe deformation which by default is set to 200%.

For simplicity, automatic generation of material parameters is available via ONEMPA.LT.0, then no other parameters are needed. If FC.EQ.0 then the 35 MPa strength concrete in Riedel (2004) is generated in the units specified by the value of ONEMPA. For FC.GT.0 then FC specifies the actual strength of the concrete in the units specified by the value of ONEMPA. The other parameters are generated by interpolating between the 35 MPa and 140 MPa strength concretes as presented in Riedel (2004). Any automatically generated parameter may be overridden by the user if motivated, one of these parameters may be the initial porosity ALPHA0 of the concrete.



\*MAT\_CHRONOLOGICAL\_VISCOELASTIC

This is Material Type 276. This material model provides a general viscoelastic Maxwell model having up to 6 terms in the prony series expansion and is useful for modeling dense continuum rubbers and solid explosives. It is similar to Material Type 76 but allows the incorporation of aging effects on the material properties. Either the coefficients of the prony series expansion or a relaxation curve may be specified to define the viscoelastic deviatoric and bulk behavior.

The material model can also be used with laminated shell. Either an elastic or viscoelastic layer can be defined with the laminated formulation. To activate laminated shell you need the laminated formulation flag on \*CONTROL\_SHELL. With the laminated option a user defined integration rule is needed.

Card 1            1            2            3            4            5            6            7            8

Variable	MID	RO	BULK	PCF	EF	TREF	A	B
Type	A8	F	F	F	F	F	F	F

**Insert a blank card here if constants are defined on cards 3,4,... below.**

**If an elastic layer is defined in a laminated shell this card must be blank.**

Card 2            1            2            3            4            5            6            7            8

Variable	LCID	NT	BSTART	TRAMP	LCIDK	NTK	BSTART K	TRAMPK
Type	F	I	F	F	F	I	F	F

**Card Format for viscoelastic constants. Up to 6 cards may be input. A keyword card (with a “\*” in column 1) terminates this input if less than 6 cards are used. These cards are not needed if relaxation data is defined. The number of terms for the shear behavior may differ from that for the bulk behavior: simply insert zero if a term is not included. If an elastic layer is defined you only need to define GI and KI (note in an elastic layer only one card is needed)**

Optional      1            2            3            4            5            6            7            8  
Cards

Variable	GI	BETAI	KI	BETAKI				
Type	F	F	F	F				

<u>VARIABLE</u>	<u>DESCRIPTION</u>
MID	Material identification. A unique number or label not exceeding 8 characters must be specified.
RO	Mass density.
BULK	Elastic bulk modulus.
PCF	Tensile pressure elimination flag for solid elements only. If set to unity tensile pressures are set to zero.
EF	Elastic flag (if equal 1, the layer is elastic. If 0 the layer is viscoelastic).
TREF	Reference temperature for shift function (must be greater than zero).
A	Chronological coefficient $\alpha(t_a)$ . See Remarks below.
B	Chronological coefficient $\beta(t_a)$ . See Remarks below.
LCID	Load curve ID for deviatoric behavior if constants, $G_i$ , and $\beta_i$ are determined via a least squares fit. This relaxation curve is shown below.
NT	Number of terms in shear fit. If zero the default is 6. Fewer than NT terms will be used if the fit produces one or more negative shear moduli. Currently, the maximum number is set to 6.
BSTART	In the fit, $\beta_1$ is set to zero, $\beta_2$ is set to BSTART, $\beta_3$ is 10 times $\beta_2$ , $\beta_4$ is 10 times $\beta_3$ , and so on. If zero, BSTART is determined by an iterative trial and error scheme.

VARIABLE	DESCRIPTION
TRAMP	Optional ramp time for loading.
LCIDK	Load curve ID for bulk behavior if constants, $K_i$ , and $\beta\kappa_i$ are determined via a least squares fit. This relaxation curve is shown below.
NTK	Number of terms desired in bulk fit. If zero the default is 6. Currently, the maximum number is set to 6.
BSTARTK	In the fit, $\beta\kappa_1$ is set to zero, $\beta\kappa_2$ is set to BSTARTK, $\beta\kappa_3$ is 10 times $\beta\kappa_2$ , $\beta\kappa_4$ is 10 times $\beta\kappa_3$ , and so on. If zero, BSTARTK is determined by an iterative trial and error scheme.
TRAMPK	Optional ramp time for bulk loading.
GI	Optional shear relaxation modulus for the $i$ th term
BETAI	Optional shear decay constant for the $i$ th term
KI	Optional bulk relaxation modulus for the $i$ th term
BETAKI	Optional bulk decay constant for the $i$ th term

### **Remarks:**

The Cauchy stress,  $\sigma_{ij}$ , is related to the strain rate by

$$\sigma_{ij}(t) = -p\delta_{ij} + \int_0^t g_{ijkl}(t-\tau) \frac{\partial \varepsilon_{kl}(\tau)}{\partial \tau} d\tau . \quad (1)$$

For this model, it is postulated that the mathematical form is preserved in the constitutive equation for aging; however two new material functions,  $g_0(t_a)$  and  $g_1(t_a, t)$  are introduced to replace  $g_0$  and  $g_1(t)$ , which is expressed in terms of a Prony series as in material model 76, \*MAT\_GENERAL\_VISCOELASTIC. The aging time is denoted by  $t_a$ .

$$\sigma_{ij}(t_a, t) = -p\delta_{ij} + \int_0^t g'_{ijkl}(t_a, t-\tau) \frac{\partial \varepsilon_{kl}(\tau)}{\partial \tau} d\tau \quad (2)$$

where

$$g'_{ijkl}(t_a, t) = \alpha(t_a) g_{ijkl}[\beta(t_a)t]. \quad (3)$$

where  $\alpha(t_a)$  and  $\beta(t_a)$  are two new material properties that are functions of the aging time  $t_a$ . The material properties functions  $\alpha(t_a)$  and  $\beta(t_a)$  will be determined with the experimental results. For determination of  $\alpha(t_a)$  and  $\beta(t_a)$ , Eq. (2) can be written in the following form

$$\log(\sigma_{ij} - p\delta_{ij})_{t_a, t} = \log \alpha(t_a) + \log(\sigma_{ij} - p\delta_{ij})_{t_a=0, t \rightarrow \xi}$$
$$\log \xi = \log \beta(t_a) + \log t \quad (4)$$

Therefore, if one plots the stress versus time on log-log scales, with the vertical axis being the stress and the horizontal axis being the time, then the stress-relaxation curve for any aged time history can be obtained directly from the stress-relaxation curve at  $t_a = 0$  by imposing a vertical shift and a horizontal shift on the stress-relaxation curves. The vertical shift and the horizontal shift are  $\log \alpha(t_a)$  and  $\log \beta(t_a)$  respectively.

**\*MAT\_ALE\_VISCOUS**

This may also be referred to as MAT\_ALE\_02. This “fluid-like” material model is very similar to Material Type 9 (\*MAT\_NULL). It allows the modeling of non-viscous fluids with constant or variable viscosity. The variable viscosity is a function of an equivalent deviatoric strain rate. If inviscid material is modeled, the deviatoric or viscous stresses are zero, and the equation of state supplies the pressures (or diagonal components of the stress tensor). All \*MAT\_ALE\_ cards apply only to ALE element formulation.

Card 1            1            2            3            4            5            6            7            8

Variable	MID	RO	PC	MULO	MUHI	RK	Not used	RN
Type	I	F	F	F	F	F		F
Defaults	none	none	0.0	0.0	0.0	0.0		0.0

**VARIABLE****DESCRIPTION**

MID	Material identification. A unique number has to be chosen.
RO	Mass density.
PC	Pressure cutoff ( $\leq 0.0$ ), (See remark 4).
MULO	There are 4 possible cases (See remark 1): 1) If MULO=0.0, then inviscid fluid is assumed. 2) If MULO > 0.0, and MUHI=0.0 or is not defined, then this is the traditional constant dynamic viscosity coefficient $\mu$ . 3) If MULO > 0.0, and MUHI > 0.0, then MULO and MUHI are lower and upper viscosity limit values for a power-law-like variable viscosity model. 4) If MULO is negative (for example, MULO = -1), then a user-input data load curve (with LCID=1) defining dynamic viscosity as a function of equivalent strain rate is used.
MUHI	Upper dynamic viscosity limit (default=0.0). This is defined only if RK and RN are defined for the variable viscosity case.
RK	Variable dynamic viscosity multiplier (See remark 6).
RN	Variable dynamic viscosity exponent (See remark 6).

**Remarks:**

- 1. The null material must be used with an equation-of-state. Pressure cutoff is negative in tension. A (deviatoric) viscous stress of the form

$$\sigma'_{ij} = 2\mu\dot{\epsilon}'_{ij}$$

$$\left[ \frac{N}{m^2} \right] \sim \left[ \frac{N}{m^2} s \right] \left[ \frac{1}{s} \right]$$

is computed for nonzero  $\mu$  where  $\dot{\epsilon}'_{ij}$  is the deviatoric strain rate.  $\mu$  is the dynamic viscosity. For example, in SI unit system,  $\mu$  has a unit of [Pa\*s].

- 2. The null material has no shear stiffness and hourglass control must be used with care. In some applications, the default hourglass coefficient might lead to significant energy losses. In general for fluid(s), the hourglass coefficient QM should be small (in the range 1.0E-4 to 1.0E-6 for the standard default IHQ choice).
- 3. Null material has no yield strength and behaves in a fluid-like manner.
- 4. The pressure cut-off, PC, must be defined to allow for a material to “numerically” cavitate. In other words, when a material undergoes dilatation above certain magnitude, it should no longer be able to resist this dilatation. Since dilatation stress or pressure is negative, setting PC limit to a very small negative number would allow for the material to cavitate once the pressure in the material goes below this negative value.
- 5. If the viscosity exponent is less than 1.0,  $RN < 1.0$ , then  $RN - 1.0 < 0.0$ . In this case, at very low equivalent strain rate, the viscosity can be artificially very high. MULO is then used as the viscosity value.
- 6. The empirical variable dynamic viscosity is typically modeled as a function of equivalent shear rate based on experimental data.

$$\mu(\dot{\gamma}') = RK \cdot \dot{\gamma}'^{(RN-1)}$$

For an incompressible fluid, this may be written equivalently as

$$\mu(\dot{\epsilon}') = RK \cdot \dot{\epsilon}'^{(RN-1)}$$

The “overbar” denotes a scalar equivalence. The “dot” denotes a time derivative or rate effect. And the “prime” symbol denotes deviatoric or volume preserving components. The equivalent shear rate components may be related to the basic definition of (small-strain) strain rate components as follows:

$$\dot{\epsilon}_{ij} = \frac{1}{2} \left( \frac{\partial u_i}{\partial x_j} + \frac{\partial u_j}{\partial x_i} \right) \Rightarrow \dot{\epsilon}'_{ij} = \dot{\epsilon}_{ij} - \delta_{ij} \left( \frac{\dot{\epsilon}_{kk}}{3} \right)$$

$$\dot{\gamma}_{ij} = 2\dot{\epsilon}'_{ij}$$

Typically, the 2<sup>nd</sup> invariant of the deviatoric strain rate tensor is defined as:

$$I_{2\dot{\epsilon}'} = \frac{1}{2} [\dot{\epsilon}'_{ij}\dot{\epsilon}'_{ij}]$$

The equivalent (small-strain) deviatoric strain rate is defined as:

$$\dot{\bar{\epsilon}}' \equiv 2\sqrt{I_{2\dot{\epsilon}'}} = \sqrt{2[\dot{\epsilon}'_{ij}\dot{\epsilon}'_{ij}]} = \sqrt{4[\dot{\epsilon}'_{12}{}^2 + \dot{\epsilon}'_{23}{}^2 + \dot{\epsilon}'_{31}{}^2] + 2[\dot{\epsilon}'_{11}{}^2 + \dot{\epsilon}'_{22}{}^2 + \dot{\epsilon}'_{33}{}^2]}$$

In non-Newtonian literatures, the equivalent shear rate is sometimes defined as

$$\dot{\bar{\gamma}} \equiv \sqrt{\frac{\dot{\gamma}_{ij}\dot{\gamma}_{ij}}{2}} = \sqrt{2\dot{\epsilon}'_{ij}\dot{\epsilon}'_{ij}} = \sqrt{4[\dot{\epsilon}'_{12}{}^2 + \dot{\epsilon}'_{23}{}^2 + \dot{\epsilon}'_{31}{}^2] + 2[\dot{\epsilon}'_{11}{}^2 + \dot{\epsilon}'_{22}{}^2 + \dot{\epsilon}'_{33}{}^2]}$$

It turns out that, (a) for incompressible materials ( $\dot{\epsilon}_{kk} = 0$ ), and (b) the shear terms are equivalent when  $i \neq j \rightarrow \dot{\epsilon}_{ij} = \dot{\epsilon}'_{ij}$ , the equivalent shear rate is algebraically equivalent to the equivalent (small-strain) deviatoric strain rate.

$$\dot{\bar{\epsilon}}' = \dot{\bar{\gamma}}$$

**\*MAT\_ALE\_GAS\_MIXTURE**

This may also be referred to as \*MAT\_ALE\_03. This model is used to simulate thermally equilibrated ideal gas mixtures. This only works with the multi-material ALE formulation (ELFORM=11 in \*SECTION\_SOLID). This keyword needs to be used together with \*INITIAL\_GAS\_MIXTURE for the initialization of gas densities and temperatures. When applied in the context of ALE airbag modeling, the injection of inflator gas is done with a \*SECTION\_POINT\_SOURCE\_MIXTURE command which controls the injection process. This is an identical material model to the \*MAT\_GAS\_MIXTURE model.

Card 1            1            2            3            4            5            6            7            8

Variable	MID	IADIAB	RUNIV					
Type	A8	I	F					
Default	none	0	0.0					
Remark		5	1					

**Card 2: Method (A) RUNIV=BLANK or 0.0 → Per-mass unit is used**

Card 2            1            2            3            4            5            6            7            8

Variable	CVmass1	CVmass2	CVmass3	CVmass4	CVmass5	CVmass6	CVmass7	Cvmass8
Type	F	F	F	F	F	F	F	F
Default	none	none	none	none	none	none	none	None
Remark								



**Card 3: Method (A) RUNIV=BLANK or 0.0 → Per-mass unit is used**

Card 3            1            2            3            4            5            6            7            8

Variable	CPmass1	CPmass2	CPmass3	CPmass4	CPmass5	CPmass6	CPmass7	Cpmass8
Type	F	F	F	F	F	F	F	F
Default	none	none	none	none	none	none	none	None
Remark								

**Card 2: Method (B) RUNIV is nonzero**

Card 2            1            2            3            4            5            6            7            8

Variable	MOLWT1	MOLWT2	MOLWT3	MOLWT4	MOLWT5	MOLWT6	MOLWT7	MOLWT8
Type	F	F	F	F	F	F	F	F
Default	none	none	none	none	none	none	none	None
Remark	2							

**Card 3: Method (B) RUNIV is nonzero → Per-mole unit is used**

Card 3            1            2            3            4            5            6            7            8

Variable	CPmole1	CPmole2	CPmole3	CPmole4	CPmole5	CPmole6	Cpmole7	CPmole8
Type	F	F	F	F	F	F	F	F
Default	none	none	none	none	None	none	none	None
Remark	2							

**Card 4: Method (B) RUNIV is nonzero**

Card 4            1            2            3            4            5            6            7            8

Variable	B1	B2	B3	B4	B5	B6	B7	B8
Type	F	F	F	F	F	F	F	F
Default	none	none	none	none	None	none	none	None
Remark	2							

**Card 5: Method (B) RUNIV is nonzero**

Card 5            1            2            3            4            5            6            7            8

Variable	C1	C2	C3	C4	C5	C6	C7	C8
Type	F	F	F	F	F	F	F	F
Default	none	none	none	none	None	none	none	None
Remark	2							

<u>VARIABLE</u>	<u>DESCRIPTION</u>
MID	Material identification. A unique number or label not exceeding 8 characters must be specified.
IADIAB	This flag (default=0) is used to turn ON/OFF adiabatic compression logics for an ideal gas (remark 5). EQ.0: OFF (default) EQ.1: ON
RUNIV	Universal gas constant in per-mole unit (8.31447 J/(mole*K)).
CVmass1- CVmass8	If RUNIV is BLANK or zero (method A): Heat capacity at constant volume for up to eight different gases in per-mass unit.
CPmass1- CPmass8	If RUNIV is BLANK or zero (method A): Heat capacity at constant pressure for up to eight different gases in per-mass unit.

VARIABLE	DESCRIPTION
MOLWT1- MOLWT8	If RUNIV is nonzero (method B): Molecular weight of each ideal gas in the mixture (mass-unit/mole).
CPmole1- CPmole8	If RUNIV is nonzero (method B): Heat capacity at constant pressure for up to eight different gases in per-mole unit. These are nominal heat capacity values typically at STP. These are denoted by the variable "A" in the equation in remark 2.
B1-B8	If RUNIV is nonzero (method B): First order coefficient for a temperature dependent heat capacity at constant pressure for up to eight different gases. These are denoted by the variable "B" in the equation in remark 2.
C1-C8	If RUNIV is nonzero (method B): Second order coefficient for a temperature dependent heat capacity at constant pressure for up to eight different gases. These are denoted by the variable "C" in the equation in remark 2.

### Remarks:

- There are 2 methods of defining the gas properties for the mixture. If RUNIV is BLANK or ZERO → Method (A) is used to define constant heat capacities where per-mass unit values of  $C_v$  and  $C_p$  are input. Only cards 2 and 3 are required for this method. Method (B) is used to define constant or temperature dependent heat capacities where per-mole unit values of  $C_p$  are input. Cards 2-5 are required for this method.

- The per-mass-unit, temperature-dependent, constant-pressure heat capacity is

$$C_p(T) = \frac{[A + B * T + C * T^2]}{MW} \sim \frac{J}{kg * K} \quad \begin{array}{l} B \sim J/(mole * K^2) \\ C \sim J/(mole * K^3) \end{array}$$

$$A = \tilde{C}_{p0} \sim J/(mole * K)$$

The units shown are only for demonstration of the equation.

- The initial temperature and the density of the gas species present in a mesh or part at time zero is specified by the keyword \*INITIAL\_GAS\_MIXTURE.

- The ideal gas mixture is assumed to be thermal equilibrium, that is, all species are at the same temperature (T). The gases in the mixture are also assumed to follow Dalton's

Partial Pressure Law,  $P = \sum_i^{ngas} P_i$ . The partial pressure of each gas is then  $P_i = \rho_i R_{gas_i} T$

where  $R_{gasi} = \frac{R_{univ}}{MW}$ . The individual gas species temperature equals the mixture

temperature. The temperature is computed from the internal energy where the *mixture internal energy per unit volume* is used,

$$e_V = \sum_i^{ngas} \rho_i C_{V_i} T_i = \sum_i^{ngas} \rho_i C_{V_i} T$$

$$T = T_i = \frac{e_V}{\sum_i^{ngas} \rho_i C_{V_i}}$$

In general, the advection step conserves momentum and internal energy, but not kinetic energy. This can result in energy lost in the system and lead to a pressure drop. In \*MAT\_GAS\_MIXTURE the dissipated kinetic energy is automatically stored in the internal energy. Thus in effect the total energy is conserved instead of conserving just the internal energy. This numerical scheme has been shown to improve accuracy in some cases. However, the user should always be vigilant and check the physics of the problem closely.

- As an example consider an airbag surrounded by ambient air. As the inflator gas flows into the bag, the ALE elements cut by the airbag fabric shell elements will contain some inflator gas inside and some ambient air outside. The multi-material element treatment is not perfect. Consequently the temperature of the outside air may, occasionally, be made artificially high after the multi-material element treatment. To prevent the outside ambient air from getting artificially high T, set IDIAB=1 for the ambient air outside. Simple adiabatic compression equation is then assumed for the outside air. The use of this flag may be needed, but only when that outside air is modeled by the \*MAT\_GAS\_MIXTURE card.

**Example:**

Consider a tank test model where the Lagrangian tank (Part S1) is surrounded by an ALE air mesh (Part H4=AMMGID 1). There are 2 ALE parts which are defined but initially have no corresponding mesh: part 5 (H5=AMMGID 2) is the resident gas inside the tank at t = 0, and part 6 (H6=AMMGID 2) is the inflator gas(es) which is injected into the tank when t > 0. AMMGID stands for ALE Multi-Material Group ID. Please see figure and input below. The \*MAT\_GAS\_MIXTURE (MGM) card defines the gas properties of ALE parts H5 & H6. The MGM card input for both method (A) and (B) are shown.

The \*INITIAL\_GAS\_MIXTURE card is also shown. It basically specifies that “AMMGID 2 may be present in part or mesh H4 at t=0, and the initial density of this gas is defined in the rho1 position which corresponds to the 1<sup>st</sup> material in the mixture (or H5, the resident gas).”

**Example configuration:**

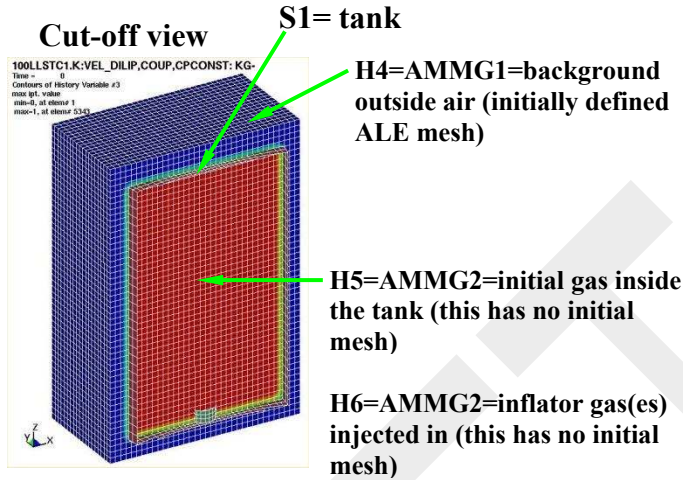

**Sample input:**

```

$-----
*PART
H5 = initial gas inside the tank
$      PID      SECID      MID      EOSID      HGID      GRAV      ADPOPT      TMID
$      5        5          5          0          5          0          0
*SECTION_SOLID
$      5          11          0
$-----
$ Example 1: Constant heat capacities using per-mass unit.
$*MAT_GAS_MIXTURE
$      MID      IADIAB      R_univ
$      5        0          0
$      Cv1_mas  Cv2_mas  Cv3_mas  Cv4_mas  Cv5_mas  Cv6_mas  Cv7_mas  Cv8_mas
$718.7828911237.56228
$      Cp1_mas  Cp2_mas  Cp3_mas  Cp4_mas  Cp5_mas  Cp6_mas  Cp7_mas  Cp8_mas
$1007.00058 1606.1117
$-----
$ Example 2: Variable heat capacities using per-mole unit.
$*MAT_GAS_MIXTURE
$      MID      IADIAB      R_univ
$      5        0      8.314470
$      MW1      MW2      MW3      MW4      MW5      MW6      MW7      MW8
$      0.0288479 0.02256
$      Cp1_mol  Cp2_mol  Cp3_mol  Cp4_mol  Cp5_mol  Cp6_mol  Cp7_mol  Cp8_mol
$      29.049852 36.23388
$      B1        B2        B3        B4        B5        B6        B7        B8
$      7.056E-3 0.132E-1
$      C1        C2        C3        C4        C5        C6        C7        C8
$      -1.225E-6 -0.190E-5
$-----
$ One card is defined for each AMMG that will occupy some elements of a mesh set
$*INITIAL_GAS_MIXTURE
$      SID      STYPE      MMGID      T0
$      4        1          1          298.15
$      RHO1      RHO2      RHO3      RHO4      RHO5      RHO6      RHO7      RHO8
$      1.17913E-9
$*INITIAL_GAS_MIXTURE
$      SID      STYPE      MMGID      T0
$      4        1          2          298.15
$      RHO1      RHO2      RHO3      RHO4      RHO5      RHO6      RHO7      RHO8
$      1.17913E-9
$-----

```

**\*MAT\_ALE\_HERSCHEL**

This may also be referred to as MAT\_ALE\_04. This is the Herschel-Buckley model. It is an enhancement to the power law viscosity model in \*MAT\_ALE\_VISCOUS(\*MAT\_ALE\_02). Two additional input parameters: the yield stress threshold and critical shear strain rate can be specified to model “rigid-like” material for low strain rates.

It allows the modeling of non-viscous fluids with constant or variable viscosity. The variable viscosity is a function of an equivalent deviatoric strain rate. All \*MAT\_ALE\_ cards apply only to ALE element formulation.

Card 1            1            2            3            4            5            6            7            8

Variable	MID	RO	PC	MULO	MUHI	RK	Not used	RN
Type	I	F	F	F	F	F		F
Defaults	none	none	0.0	0.0	0.0	0.0		0.0

Card 2            1            2            3            4            5            6            7            8

Variable	GDOTC	TAO0						
Type	F	F						
Default	none	none						

<u>VARIABLE</u>	<u>DESCRIPTION</u>
MID	Material identification. A unique number has to be chosen.
RO	Mass density.
PC	Pressure cutoff ( $\leq 0.0$ ), (See remark 4).

VARIABLE	DESCRIPTION
MULO	There are 4 possible cases (See remark 1): 1) If MULO=0.0, then inviscid fluid is assumed. 2) If MULO > 0.0, and MUHI=0.0 or is not defined, then this is the traditional constant dynamic viscosity coefficient $\mu$ . 3) If MULO > 0.0, and MUHI > 0.0, then MULO and MUHI are lower and upper viscosity limit values for a power-law-like variable viscosity model. 4) If MULO is negative (for example, MULO = -1), then a user-input data load curve (with LCID=1) defining dynamic viscosity as a function of equivalent strain rate is used.
MUHI	Upper dynamic viscosity limit (default=0.0). This is defined only if RK and RN are defined for the variable viscosity case.
RK	$k$ ; consistency factor (See remark 6).
RN	$n$ ; power law index (See remark 6).
GDOTC	$\dot{\gamma}_c$ ; critical shear strain rate (See remark 6).
TAO0	$\tau_0$ ; yield stress (See remark 6).

### **Remarks:**

1. The null material must be used with an equation-of-state. Pressure cutoff is negative in tension. A (deviatoric) viscous stress of the form

$$\sigma'_{ij} = 2\mu\dot{\epsilon}'_{ij}$$

$$\left[ \frac{N}{m^2} \right] \sim \left[ \frac{N}{m^2} s \right] \left[ \frac{1}{s} \right]$$

- is computed for nonzero  $\mu$  where  $\dot{\epsilon}'_{ij}$  is the deviatoric strain rate.  $\mu$  is the dynamic viscosity. For example, in SI unit system,  $\mu$  has a unit of [Pa\*s].
2. The null material has no shear stiffness and hourglass control must be used with care. In some applications, the default hourglass coefficient might lead to significant energy losses. In general for fluid(s), the hourglass coefficient QM should be small (in the range 1.0E-4 to 1.0E-6 for the standard default IHQ choice).
  3. Null material has no yield strength and behaves in a fluid-like manner.
  4. The pressure cut-off, PC, must be defined to allow for a material to “numerically” cavitate. In other words, when a material undergoes dilatation above certain magnitude,

it should no longer be able to resist this dilatation. Since dilatation stress or pressure is negative, setting PC limit to a very small negative number would allow for the material to cavitate once the pressure in the material goes below this negative value.

- 5. If the viscosity exponent is less than 1.0,  $RN < 1.0$ , then  $RN - 1.0 < 0.0$ . In this case, at very low equivalent strain rate, the viscosity can be artificially very high. MULO is then used as the viscosity value.
- 6. The Herschel-Buckley model employs a large viscosity to model the “rigid-like” behavior for low shear strain rates ( $\dot{\gamma} < \dot{\gamma}_c$ ).

$$\mu = \mu_0$$

Power law is used once the yield stress is passed.

$$\mu(\dot{\gamma}) = \frac{\tau_0}{\dot{\gamma}} + k \left( \frac{\dot{\gamma}}{\dot{\gamma}_c} \right)^{n-1}$$

The shear strain rate is:

$$\dot{\gamma} \equiv \sqrt{\frac{\dot{\gamma}_{ij} \dot{\gamma}_{ij}}{2}} = \sqrt{2 \dot{\epsilon}_{ij} \dot{\epsilon}_{ij}} = \sqrt{4 [\dot{\epsilon}_{12}^2 + \dot{\epsilon}_{23}^2 + \dot{\epsilon}_{31}^2] + 2 [\dot{\epsilon}_{11}^2 + \dot{\epsilon}_{22}^2 + \dot{\epsilon}_{33}^2]}$$



**\*MAT\_SPRING\_ELASTIC**

This is Material Type 1 for discrete springs and dampers. This provides a translational or rotational elastic spring located between two nodes. Only one degree of freedom is connected.

Card 1            1            2            3            4            5            6            7            8

Variable	MID	K						
Type	A8	F						

**VARIABLE**

**DESCRIPTION**

- MID            Material identification. A unique number or label not exceeding 8 characters must be specified.
- K              Elastic stiffness (force/displacement) or (moment/rotation).

**\*MAT\_DAMPER\_VISCOUS**

This is Material Type 2 for discrete springs and dampers. This material provides a linear translational or rotational damper located between two nodes. Only one degree of freedom is then connected.

Card 1            1            2            3            4            5            6            7            8

Variable	MID	DC						
Type	A8	F						

<u>VARIABLE</u>	<u>DESCRIPTION</u>
MID	Material identification. A unique number or label not exceeding 8 characters must be specified.
DC	Damping constant (force/displacement rate) or (moment/rotation rate).

**\*MAT\_SPRING\_ELASTOPLASTIC**

This is Material Type 3 for discrete springs and dampers. This material provides an elastoplastic translational or rotational spring with isotropic hardening located between two nodes. Only one degree of freedom is connected.

Card 1            1            2            3            4            5            6            7            8

Variable	MID	K	KT	FY				
Type	A8	F	F	F				

<u>VARIABLE</u>	<u>DESCRIPTION</u>
MID	Material identification. A unique number or label not exceeding 8 characters must be specified.
K	Elastic stiffness (force/displacement) or (moment/rotation).
KT	Tangent stiffness (force/displacement) or (moment/rotation).
FY	Yield (force) or (moment).

**\*MAT\_SPRING\_NONLINEAR\_ELASTIC**

This is Material Type 4 for discrete springs and dampers. This material provides a nonlinear elastic translational and rotational spring with arbitrary force versus displacement and moment versus rotation, respectively. Optionally, strain rate effects can be considered through a velocity dependent scale factor. With the spring located between two nodes, only one degree of freedom is connected.

Card 1            1            2            3            4            5            6            7            8

Variable	MID	LCD	LCR					
Type	A8	I	I					

<u>VARIABLE</u>	<u>DESCRIPTION</u>
MID	Material identification. A unique number or label not exceeding 8 characters must be specified.
LCD	Load curve ID describing force versus displacement or moment versus rotation relationship
LCR	Optional load curve describing scale factor on force or moment as a function of relative velocity or rotational velocity, respectively. <u>The load curve must define the response in the negative and positive quadrants and pass through point (0,0).</u>

\*MAT\_DAMPER\_NONLINEAR\_VISCOUS

This is Material Type 5 for discrete springs and dampers. This material provides a viscous translational damper with an arbitrary force versus velocity dependency, or a rotational damper with an arbitrary moment versus rotational velocity dependency. With the damper located between two nodes, only one degree of freedom is connected.

Card 1            1            2            3            4            5            6            7            8

Variable	MID	LCDR							
Type	A8	I							

<u>VARIABLE</u>	<u>DESCRIPTION</u>
MID	Material identification. A unique number or label not exceeding 8 characters must be specified.
LCDR	Load curve identification describing force versus rate-of-displacement relationship or a moment versus rate-of-rotation relationship. <u>The load curve must define the response in the negative and positive quadrants and pass through point (0,0).</u>

**\*MAT\_SPRING\_GENERAL\_NONLINEAR**

This is Material Type 6 for discrete springs and dampers. This material provides a general nonlinear translational or rotational spring with arbitrary loading and unloading definitions. Optionally, hardening or softening can be defined. With the spring located between two nodes, only one degree of freedom is connected.

Card 1            1            2            3            4            5            6            7            8

Variable	MID	LCDL	LCDU	BETA	TYI	CYI		
Type	A8	I	I	F	F	F		

<u>VARIABLE</u>	<u>DESCRIPTION</u>
MID	Material identification. A unique number or label not exceeding 8 characters must be specified.
LCDL	Load curve identification describing force/torque versus displacement/rotation relationship for loading, see Figure 126.1.
LCDU	Load curve identification describing force/torque versus displacement/rotation relationship for unloading, see Figure 119.1.
BETA	Hardening parameter, $\beta$ : EQ.0.0: tensile and compressive yield with strain softening (negative or zero slope allowed in the force versus displacement. load curves), NE.0.0: kinematic <b>hardening without strain softening</b> , EQ.1.0: isotropic <b>hardening without strain softening</b> .
TYI	Initial yield force in tension ( > 0)
CYI	Initial yield force in compression ( < 0)

**Remarks:**

Load curve points are in the format (displacement, force or rotation, moment). The points must be in order starting with the most negative (compressive) displacement or rotation and ending with the most positive (tensile) value. The curves need not be symmetrical.

The displacement origin of the “unloading” curve is arbitrary, since it will be shifted as necessary as the element extends and contracts. On reverse yielding the “loading” curve will also be shifted along the displacement re or. rotation axis. The initial tensile and compressive yield forces (TYI and CYI) define a range within which the element remains elastic (i.e. the

“loading” curve is used for both loading and unloading). If at any time the force in the element exceeds this range, the element is deemed to have yielded, and at all subsequent times the “unloading” curve is used for unloading.

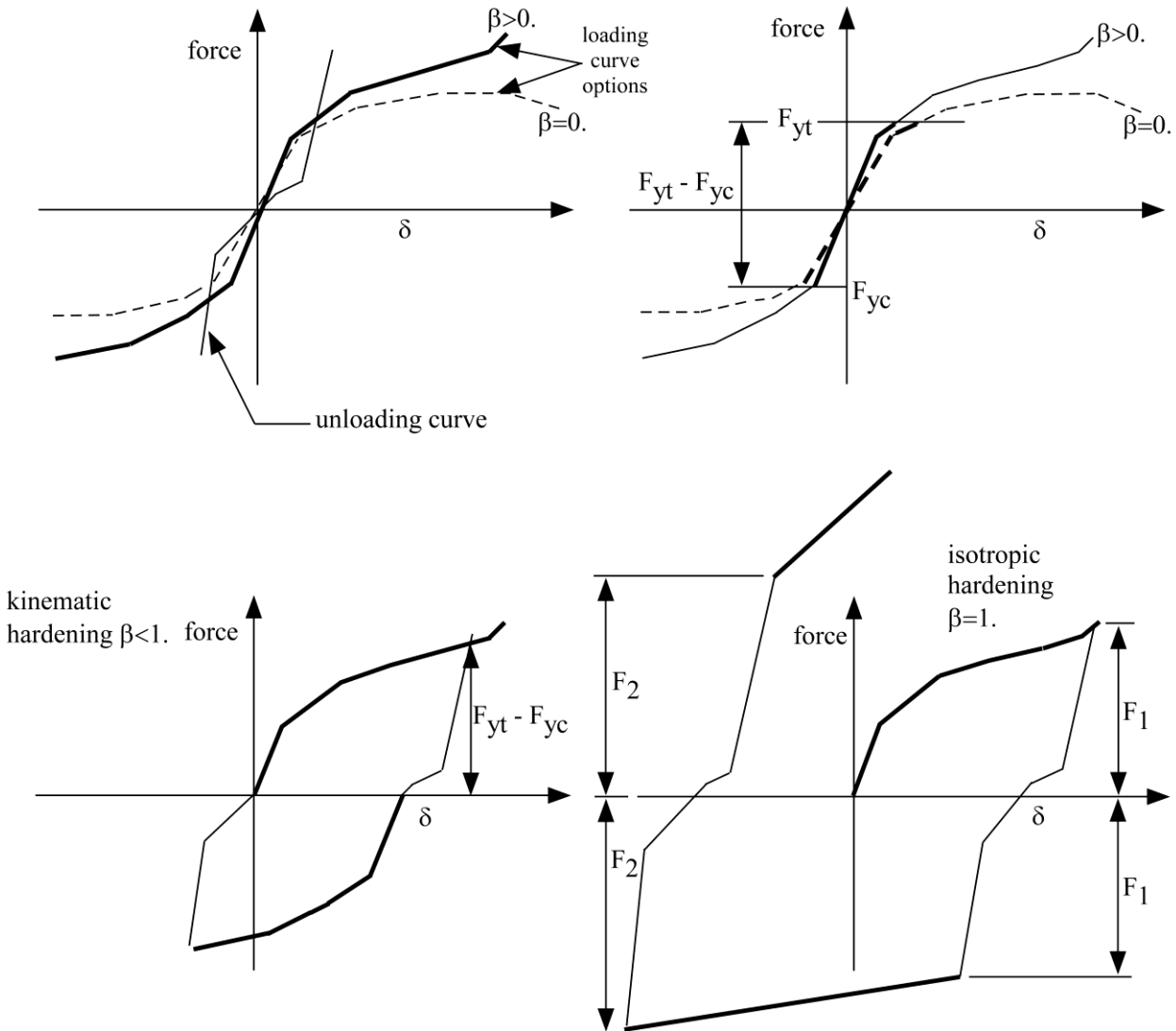

Figure S06.1. General nonlinear material for discrete elements.

**\*MAT\_SPRING\_MAXWELL**

This is Material Type 7 for discrete springs and dampers. This material provides a three Parameter Maxwell Viscoelastic translational or rotational spring. Optionally, a cutoff time with a remaining constant force/moment can be defined.

Card 1            1            2            3            4            5            6            7            8

Variable	MID	K0	KI	BETA	TC	FC	COPT	
Type	A8	F	F	F	F	F	F	
Default					1020	0	0	

<u>VARIABLE</u>	<u>DESCRIPTION</u>
MID	Material identification. A unique number or label not exceeding 8 characters must be specified.
K0	$K_0$ , short time stiffness
KI	$K_\infty$ , long time stiffness
BETA	Decay parameter.
TC	Cut off time. After this time a constant force/moment is transmitted.
FC	Force/moment after cutoff time
COPT	Time implementation option: EQ.0: incremental time change, NE.0: continuous time change.

**Remarks:**

The time varying stiffness  $K(t)$  may be described in terms of the input parameters as

$$K(t) = K_\infty + (K_0 - K_\infty)e^{-\beta t}.$$

This equation was implemented by Schwer [1991] as either a continuous function of time or incrementally following the approach of Herrmann and Peterson [1968]. The continuous function of time implementation has the disadvantage of the energy absorber's resistance decaying with increasing time even without deformation. The advantage of the incremental



implementation is that an energy absorber must undergo some deformation before its resistance decays, i.e., there is no decay until impact, even in delayed impacts. The disadvantage of the incremental implementation is that very rapid decreases in resistance cannot be easily matched.

DRAFT

**\*MAT\_SPRING\_INELASTIC**

This is Material Type 8 for discrete springs and dampers. This material provides an inelastic tension or compression only, translational or rotational spring. Optionally, a user-specified unloading stiffness can be taken instead of the maximum loading stiffness.

Card 1            1            2            3            4            5            6            7            8

Variable	MID	LCFD	KU	CTF				
Type	A8	I	F	F				

<u>VARIABLE</u>	<u>DESCRIPTION</u>
MID	Material identification. A unique number or label not exceeding 8 characters must be specified.
LCFD	Load curve identification describing arbitrary force/torque versus displacement/rotation relationship. This curve must be defined in the positive force-displacement quadrant regardless of whether the spring acts in tension or compression.
KU	Unloading stiffness (optional). The maximum of KU and the maximum loading stiffness in the force/displacement or the moment/rotation curve is used for unloading.
CTF	Flag for compression/tension: EQ.-1.0: tension only, EQ.0.0: default is set to 1.0, EQ.1.0: compression only.

**\*MAT\_SPRING\_TRILINEAR\_DEGRADING**

This is Material Type 13 for discrete springs and dampers. This material allows concrete shearwalls to be modeled as discrete elements under applied seismic loading. It represents cracking of the concrete, yield of the reinforcement and overall failure. Under cyclic loading, the stiffness of the spring degrades but the strength does not.

Card 1            1            2            3            4            5            6            7            8

Variable	MID	DEFL1	F1	DEFL2	F2	DEFL3	F3	FFLAG
Type	A8	F	F	F	F	F	F	F

<u>VARIABLE</u>	<u>DESCRIPTION</u>
MID	Material identification. A unique number or label not exceeding 8 characters must be specified.
DEFL1	Deflection at point where concrete cracking occurs.
F1	Force corresponding to DEFL1
DEFL2	Deflection at point where reinforcement yields
F2	Force corresponding to DEFL2
DEFL3	Deflection at complete failure
F3	Force corresponding to DEFL3
FFLAG	Failure flag.

**\*MAT\_SPRING\_SQUAT\_SHEARWALL**

This is Material Type 14 for discrete springs and dampers. This material allows squat shear walls to be modeled using discrete elements. The behavior model captures concrete cracking, reinforcement yield, ultimate strength followed by degradation of strength finally leading to collapse.

Card 1            1            2            3            4            5            6            7            8

Variable	MID	A14	B14	C14	D14	E14	LCID	FSD
Type	A8	F	F	F	F	F	I	F

<u>VARIABLE</u>	<u>DESCRIPTION</u>
MID	Material identification. A unique number or label not exceeding 8 characters must be specified.
A14	Material coefficient A
B14	Material coefficient B
C14	Material coefficient C
D14	Material coefficient D
E14	Material coefficient E
LCID	Load curve ID referencing the maximum strength envelope curve
FSD	Sustained strength reduction factor

**Remarks:**

Material coefficients A, B, C and D are empirically defined constants used to define the shape of the polynomial curves which govern the cyclic behavior of the discrete element. A different polynomial relationship is used to define the loading and unloading paths allowing energy absorption through hysteresis. Coefficient E is used in the definition of the path used to ‘jump’ from the loading path to the unloading path (or vice versa) where a full hysteresis loop is not completed. The load curve referenced is used to define the force displacement characteristics of the shear wall under monotonic loading. This curve is the basis to which the polynomials defining the cyclic behavior refer to. Finally, on the second and subsequent loading / unloading cycles, the shear wall will have reduced strength. The variable FSD is the sustained strength reduction factor.

\*MAT\_SPRING\_MUSCLE

This is Material Type 15 for discrete springs and dampers. This material is a Hill-type muscle model with activation. It is for use with discrete elements. The LS-DYNA implementation is due to Dr. J.A. Weiss.

Card 1            1            2            3            4            5            6            7            8

Variable	MID	L0	VMAX	SV	A	FMAX	TL	TV
Type	A8	F	F	F	F	F	F	F
Default		1.0		1.0			1.0	1.0

Card 2            1            2            3            4            5            6            7            8

Variable	FPE	LMAX	KSH					
Type	F	F	F					
Default	0.0							

<u>VARIABLE</u>	<u>DESCRIPTION</u>
MID	Material identification. A unique number or label not exceeding 8 characters must be specified.
L0	Initial muscle length, $L_0$ .
VMAX	Maximum CE shortening velocity, $V_{max}$ .
SV	Scale factor, $S_v$ , for $V_{max}$ vs. active state. LT.0: absolute value gives load curve ID GE.0: constant value of 1.0 is used
A	Activation level vs. time function. LT.0: absolute value gives load curve ID GE.0: constant value of $A$ is used
FMAX	Peak isometric force, $F_{max}$ .

---

<u>VARIABLE</u>	<u>DESCRIPTION</u>
TL	Active tension vs. length function. LT.0: absolute value gives load curve ID GE.0: constant value of 1.0 is used
TV	Active tension vs. velocity function. LT.0: absolute value gives load curve ID GE.0: constant value of 1.0 is used
FPE	Force vs. length function, $F_{pe}$ , for parallel elastic element. LT.0: absolute value gives load curve ID EQ.0: exponential function is used (see below) GT.0: constant value of 0.0 is used
LMAX	Relative length when $F_{pe}$ reaches $F_{max}$ . Required if $F_{pe}=0$ above.
KSH	Constant, $K_{sh}$ , governing the exponential rise of $F_{pe}$ . Required if $F_{pe}=0$ above.

**Remarks:**

The material behavior of the muscle model is adapted from the original model proposed by Hill [1938]. Reviews of this model and extensions can be found in Winters [1990] and Zajac [1989]. The most basic Hill-type muscle model consists of a contractile element (CE) and a parallel elastic element (PE) (Figure 139.1). An additional series elastic element (SEE) can be added to represent tendon compliance. The main assumptions of the Hill model are that the contractile element is entirely stress free and freely distensible in the resting state, and is described exactly by Hill's equation (or some variation). When the muscle is activated, the series and parallel elements are elastic, and the whole muscle is a simple combination of identical sarcomeres in series and parallel. The main criticism of Hill's model is that the division of forces between the parallel elements and the division of extensions between the series elements is arbitrary, and cannot be made without introducing auxiliary hypotheses. However, these criticisms apply to any discrete element model. Despite these limitations, the Hill model has become extremely useful for modeling musculoskeletal dynamics, as illustrated by its widespread use today.

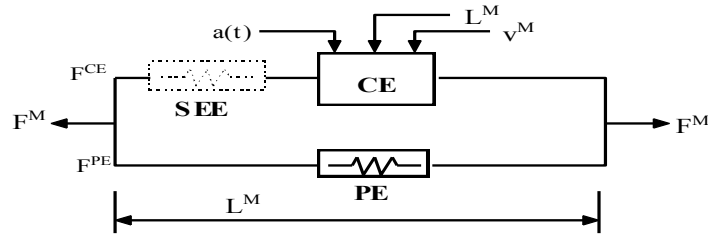

**Figure S15.1.** Discrete model for muscle contraction dynamics, based on a Hill-type representation. The total force is the sum of passive force  $F^{PE}$  and active force  $F^{CE}$ . The passive element (PE) represents energy storage from muscle elasticity, while the contractile element (CE) represents force generation by the muscle. The series elastic element (SEE), shown in dashed lines, is often neglected when a series tendon compliance is included. Here,  $a(t)$  is the activation level,  $L^M$  is the length of the muscle, and  $v^M$  is the shortening velocity of the muscle.

When the contractile element (CE) of the Hill model is inactive, the entire resistance to elongation is provided by the PE element and the tendon load-elongation behavior. As activation is increased, force then passes through the CE side of the parallel Hill model, providing the contractile dynamics. The original Hill model accommodated only full activation - this limitation is circumvented in the present implementation by using the modification suggested by Winters (1990). The main features of his approach were to realize that the CE force-velocity input force equals the CE tension-length output force. This yields a three-dimensional curve to describe the force-velocity-length relationship of the CE. If the force-velocity y-intercept scales with activation, then given the activation, length and velocity, the CE force can be determined.

Without the SEE, the total force in the muscle  $F^M$  is the sum of the force in the CE and the PE because they are in parallel:

$$F^M = F^{PE} + F^{CE}$$

The relationships defining the force generated by the CE and PE as a function of  $L^M$ ,  $V^M$  and  $a(t)$  are often scaled by  $F_{max}$ , the peak isometric force (p. 80, Winters 1990),  $L_0$ , the initial length of the muscle (p. 81, Winters 1990), and  $V_{max}$ , the maximum unloaded CE shortening velocity (p. 80, Winters 1990). From these, dimensionless length and velocity can be defined:

$$L = \frac{L^M}{L_0},$$

$$V = \frac{V^M}{V_{max} * S_v(a(t))}$$

Here,  $S_v$  scales the maximum CE shortening velocity  $V_{max}$  and changes with activation level  $a(t)$ . This has been suggested by several researchers, i.e. Winters and Stark [1985]. The activation level specifies the level of muscle stimulation as a function of time. Both have values between 0 and 1. The functions  $S_v(a(t))$  and  $a(t)$  are specified via load curves in LS-DYNA, or default

values of  $S_v=1$  and  $a(t)=0$  are used. Note that  $L$  is always positive and that  $V$  is positive for lengthening and negative for shortening.

The relationship between  $F^{CE}$ ,  $V$  and  $L$  was proposed by Bahler et al. [1967]. A three-dimensional relationship between these quantities is now considered standard for computer implementations of Hill-type muscle models [Winters 1990]. It can be written in dimensionless form as:

$$F^{CE} = a(t) * F_{max} * f_{TL}(L) * f_{TV}(V)$$

Here,  $f_{TL}$  and  $f_{TV}$  are the tension-length and tension-velocity functions for active skeletal muscle. Thus, if current values of  $L^M$ ,  $V^M$ , and  $a(t)$  are known, then  $F^{CE}$  can be determined (Figure 139.1).

The force in the parallel elastic element  $F^{PE}$  is determined directly from the current length of the muscle using an exponential relationship [Winters 1990]:

$$f_{PE} = \frac{F^{PE}}{F_{MAX}} = 0, \quad L \leq 1$$

$$f_{PE} = \frac{F^{PE}}{F_{MAX}} = \frac{1}{\exp(K_{sh}) - 1} \left[ \exp\left(\frac{K_{sh}}{L_{max}}(L - 1)\right) - 1 \right], \quad L > 1$$

Here,  $L_{max}$  is the relative length at which the force  $F_{max}$  occurs, and  $K_{sh}$  is a dimensionless shape parameter controlling the rate of rise of the exponential. Alternatively, the user can define a custom  $f_{PE}$  curve giving tabular values of normalized force versus dimensionless length as a load curve.

For computation of the total force developed in the muscle  $F^M$ , the functions for the tension-length  $f_{TL}$  and force-velocity  $f_{TV}$  relationships used in the Hill element must be defined. These relationships have been available for over 50 years, but have been refined to allow for behavior such as active lengthening. The active tension-length curve  $f_{TL}$  describes the fact that isometric muscle force development is a function of length, with the maximum force occurring at an optimal length. According to Winters, this optimal length is typically around  $L=1.05$ , and the force drops off for shorter or longer lengths, approaching zero force for  $L=0.4$  and  $L=1.5$ . Thus the curve has a bell-shape. Because of the variability in this curve between muscles, the user must specify the function  $f_{TL}$  via a load curve, specifying pairs of points representing the normalized force (with values between 0 and 1) and normalized length  $L$  (Figure 163.1).



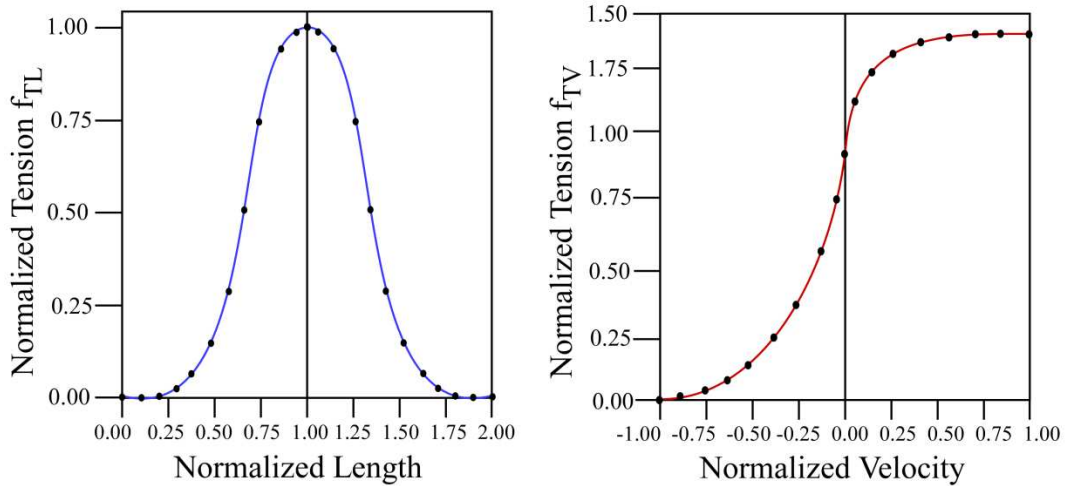

**Figure S15.2.** Typical normalized tension-length (TL) and tension-velocity (TV) curves for skeletal muscle.

The active tension-velocity relationship  $f_{TV}$  used in the muscle model is mainly due to the original work of Hill. Note that the dimensionless velocity  $V$  is used. When  $V=0$ , the normalized tension is typically chosen to have a value of 1.0. When  $V$  is greater than or equal to 0, muscle lengthening occurs. As  $V$  increases, the function is typically designed so that the force increases from a value of 1.0 and asymptotes towards a value near 1.4. When  $V$  is less than zero, muscle shortening occurs and the classic Hill equation hyperbola is used to drop the normalized tension to 0 (Figure 163.1). The user must specify the function  $f_{TV}$  via a load curve, specifying pairs of points representing the normalized tension (with values between 0 and 1) and normalized velocity  $V$ .

**\*MAT\_SEATBELT**

Purpose: Define a seat belt material. See notes below.

Card 1            1            2            3            4            5            6            7            8

Variable	MID	MPUL	LLCID	ULCID	LMIN			
Type	A8	F	I	I	F			
Default	0	0.	0	0	0.0			

<u>VARIABLE</u>	<u>DESCRIPTION</u>
MID	Belt material number. A unique number or label not exceeding 8 characters must be specified.
MPUL	Mass per unit length
LLCID	Load curve identification for loading (force vs. engineering strain).
ULCID	Load curve identification for unloading (force vs. engineering strain).
LMIN	Minimum length (for elements connected to slip rings and retractors), see notes below.
CSE	Optional compressive stress elimination option which applies to shell elements only (default 0.0): EQ.0.0: eliminate compressive stresses in shell fabric EQ.1.0: don't eliminate compressive stresses. This option should not be used if retractors and sliprings are present in the model. EQ.2.0: whether or not compressive stress is eliminated is decided by ls-dyna automatically, recommended for shell belt.
DAMP	Optional Rayleigh damping coefficient, which applies to shell elements only. A coefficient value of 0.10 is the default corresponding to 10% of critical damping. Sometimes smaller or larger values work better.

**Remarks:**

Each belt material defines stretch characteristics and mass properties for a set of belt elements. The user enters a load curve for loading, the points of which are (Strain, Force). Strain is defined as engineering strain, i.e.

$$\text{Strain} = \frac{\text{current length}}{\text{initial length}} - 1.$$

Another similar curve is entered to describe the unloading behavior. Both load curves should start at the origin (0,0) and contain positive force and strain values only. The belt material is tension only with zero forces being generated whenever the strain becomes negative. The first non-zero point on the loading curve defines the initial yield point of the material. On unloading, the unloading curve is shifted along the strain axis until it crosses the loading curve at the 'yield' point from which unloading commences. If the initial yield has not yet been exceeded or if the origin of the (shifted) unloading curve is at negative strain, the original loading curves will be used for both loading and unloading. If the strain is less than the strain at the origin of the unloading curve, the belt is slack and no force is generated. Otherwise, forces will then be determined by the unloading curve for unloading and reloading until the strain again exceeds yield after which the loading curves will again be used.

A small amount of damping is automatically included. This reduces high frequency oscillation, but, with realistic force-strain input characteristics and loading rates, does not significantly alter the overall forces-strain performance. The damping force opposes the relative motion of the nodes and is limited by stability:

$$D = \frac{.1 \times \text{mass} \times \text{relativevelocity}}{\text{timestepsize}}$$

In addition, the magnitude of the damping force is limited to one-tenth of the force calculated from the force-strain relationship and is zero when the belt is slack. Damping forces are not applied to elements attached to slings and retractors.

The user inputs a mass per unit length that is used to calculate nodal masses on initialization.

A 'minimum length' is also input. This controls the shortest length allowed in any element and determines when an element passes through slings or are absorbed into the retractors. One tenth of a typical initial element length is usually a good choice.

**\*MAT\_THERMAL\_{OPTION}**

Available options include:

**ISOTROPIC****ORTHOTROPIC****ISOTROPIC\_TD****ORTHOTROPIC\_TD****ISOTROPIC\_PHASE\_CHANGE****ISOTROPIC\_TD\_LC**

The **\*MAT\_THERMAL\_** cards allow thermal properties to be defined in coupled structural/thermal and thermal only analyses, see **\*CONTROL\_SOLUTION**. Thermal properties must be defined for all solid and shell elements in such analyses. Thermal properties need not be defined for beam or discrete elements as these elements are not accounted for in the thermal phase of the calculation. However dummy thermal properties will be echoed for these elements in the D3HSP file.

Thermal material properties are specified by a thermal material ID number (TMID), this number is independent of the material ID number (MID) defined on all other **\*MAT\_..** property cards. In the same analysis identical TMID and MID numbers may exist. The TMID and MID numbers are related through the **\*PART** card.

**\*MAT\_THERMAL\_ISOTROPIC**

This is thermal material property type 1. It allows isotropic thermal properties to be defined.

Card 1            1            2            3            4            5            6            7            8

Variable	TMID	TRO	TGRLC	TGMULT	TLAT	HLAT		
Type	A8	F	F	F	F	F		

Card 2            1            2            3            4            5            6            7            8

Variable	HC	TC						
Type	F	F						

<u>VARIABLE</u>	<u>DESCRIPTION</u>
TMID	Thermal material identification. A unique number or label not exceeding 8 characters must be specified.
TRO	Thermal density: EQ 0.0 default to structural density.
TGRLC	Thermal generation rate curve number, see *DEFINE_CURVE: GT.0: function versus time, EQ.0: use constant multiplier value, TGMULT, LT.0: function versus temperature.
TGMULT	Thermal generation rate multiplier: EQ.0.0: no heat generation.
TLAT	Phase change temperature
HLAT	Latent heat
HC	Heat capacity
TC	Thermal conductivity

**\*MAT\_THERMAL\_ORTHOTROPIC**

This is thermal material property type 2. It allows orthotropic thermal properties to be defined.

Card 1            1            2            3            4            5            6            7            8

Variable	TMID	TRO	TGRLC	TGMULT	AOPT	TLAT	HLAT	
Type	A8	F	F	F	F	F	F	

Card 2            1            2            3            4            5            6            7            8

Variable	HC	K1	K2	K3				
Type	F	F	F	F				

Card 3            1            2            3            4            5            6            7            8

Variable	XP	YP	ZP	A1	A2	A3		
Type	F	F	F	F	F	F		

Card 4            1            2            3            4            5            6            7            8

Variable	D1	D2	D3					
Type	F	F	F					

<u>VARIABLE</u>	<u>DESCRIPTION</u>
TMID	Thermal material identification. A unique number or label not exceeding 8 characters must be specified.
TRO	Thermal density: EQ 0.0 default to structural density.

VARIABLE	DESCRIPTION
TGRLC	Thermal generation rate curve number, see *DEFINE_CURVE: GT.0: function versus time, EQ.0: use constant multiplier value, TGMULT, LT.0: function versus temperature.
TGMULT	Thermal generation rate multiplier: EQ.0.0: no heat generation.
AOPT	Material axes definition: EQ.0.0: locally orthotropic with material axes by element nodes $N_1$ , $N_2$ and $N_4$ , EQ.1.0: locally orthotropic with material axes determined by a point in space and global location of element center, EQ.2.0: globally orthotropic with material axes determined by vectors.
TLAT	Phase change temperature
HLAT	Latent heat
HC	Heat capacity
K1	Thermal conductivity $K_1$ in local x-direction
K2	Thermal conductivity $K_2$ in local y-direction
K3	Thermal conductivity $K_3$ in local z-direction
XP, YP, ZP	Define coordinate of point $\mathbf{p}$ for AOPT = 1
A1, A2, A3	Define components of vector $\mathbf{a}$ for AOPT = 2
D1, D2, D3	Define components of vector $\mathbf{v}$ for AOPT = 2

**\*MAT\_THERMAL\_ISOTROPIC\_TD**

This is thermal material property type 3. It allows temperature dependent isotropic properties to be defined. The temperature dependency is defined by specifying a minimum of two and a maximum of eight data points. The properties must be defined for the temperature range that the material will see in the analysis.

Card 1            1            2            3            4            5            6            7            8

Variable	TMID	TRO	TGRLC	TGMULT	TLAT	HLAT		
Type	A8	F	F	F	F	F		

Card 2            1            2            3            4            5            6            7            8

Variable	T1	T2	T3	T4	T5	T6	T7	T8
Type	F	F	F	F	F	F	F	F

Card 3            1            2            3            4            5            6            7            8

Variable	C1	C2	C3	C4	C5	C6	C7	C8
Type	F	F	F	F	F	F	F	F

Card 4            1            2            3            4            5            6            7            8

Variable	K1	K2	K3	K4	K5	K6	K7	K8
Type	F	F	F	F	F	F	F	F

<u>VARIABLE</u>	<u>DESCRIPTION</u>
TMID	Thermal material identification. A unique number or label not exceeding 8 characters must be specified.



---

<u>VARIABLE</u>	<u>DESCRIPTION</u>
TRO	Thermal density: EQ 0.0 default to structural density.
TGRLC	Thermal generation rate curve number, see *DEFINE_CURVE: GT.0: function versus time, EQ.0: use constant multiplier value, TGMULT, LT.0: function versus temperature.
TGMULT	Thermal generation rate multiplier: EQ.0.0: no heat generation.
TLAT	Phase change temperature
HLAT	Latent heat
T1 ... T8	Temperatures (T1 ... T8)
C1 ... C8	Heat capacity at T1 ... T8
K1 ... K8	Thermal conductivity at T1 ... T8

**\*MAT\_THERMAL\_ORTHOTROPIC\_TD**

This is thermal material property type 4. It allows temperature dependent orthotropic properties to be defined. The temperature dependency is defined by specifying a minimum of two and a maximum of eight data points. The properties must be defined for the temperature range that the material will see in the analysis.

Card 1            1            2            3            4            5            6            7            8

Variable	TMID	TRO	TGRLC	TGMULT	AOPT	TLAT	HLAT	
Type	A8	F	F	F	F	F	F	

Card 2            1            2            3            4            5            6            7            8

Variable	T1	T2	T3	T4	T5	T6	T7	T8
Type	F	F	F	F	F	F	F	F

Card 3            1            2            3            4            5            6            7            8

Variable	C1	C2	C3	C4	C5	C6	C7	C8
Type	F	F	F	F	F	F	F	F

Card 4            1            2            3            4            5            6            7            8

Variable	(K1)1	(K1)2	(K1)3	(K1)4	(K1)5	(K1)6	(K1)7	(K1)8
Type	F	F	F	F	F	F	F	F

Card 5            1            2            3            4            5            6            7            8

Variable	(K2)1	(K2)2	(K2)3	(K2)4	(K2)5	(K2)6	(K2)7	(K2)8
Type	F	F	F	F	F	F	F	F

Card 6            1            2            3            4            5            6            7            8

Variable	(K3)1	(K3)2	(K3)3	(K3)4	(K3)5	(K3)6	(K3)7	(K3)8
Type	F	F	F	F	F	F	F	F

Card 7            1            2            3            4            5            6            7            8

Variable	XP	YP	ZP	A1	A2	A3		
Type	F	F	F	F	F	F		

Card 8            1            2            3            4            5            6            7            8

Variable	D1	D2	D3					
Type	F	F	F					

**VARIABLE**

**DESCRIPTION**

- TMID            Thermal material identification. A unique number or label not exceeding 8 characters must be specified.
- TRO            Thermal density:  
EQ 0.0 default to structural density.

<b>VARIABLE</b>	<b>DESCRIPTION</b>
TGRLC	Thermal generation rate curve number, see *DEFINE_CURVE: GT.0: function versus time, EQ.0: use constant multiplier value, TGMULT, LT.0: function versus temperature.
TGMULT	Thermal generation rate multiplier: EQ.0.0: no heat generation.
AOPT	Material axes definition: (see Mat_OPTION TROPIC_ELASTIC for a more complete description): EQ.0.0: locally orthotropic with material axes by element nodes $N_1$ , $N_2$ and $N_4$ , EQ.1.0: locally orthotropic with material axes determined by a point in space and global location of element center, EQ.2.0: globally orthotropic with material axes determined by vectors.
TLAT	Phase change temperature
HLAT	Latent heat
T1 ... T8	Temperatures (T1 ... T8)
C1 ... C8	Heat capacity at T1 ... T8
(K1)1 ... (K1)8	Thermal conductivity $K_1$ in local x-direction at T1 ... T8
(K2)1 ... (K2)8	Thermal conductivity $K_2$ in local y-direction at T1 ... T8
(K3)1 ... (K3)8	Thermal conductivity $K_3$ in local z-direction at T1 ... T8
XP, YP, ZP	Define coordinate of point <b>p</b> for AOPT = 1
A1, A2, A3	Define components of vector <b>a</b> for AOPT = 2
D1, D2, D3	Define components of vector <b>d</b> for AOPT = 2

\*MAT\_THERMAL\_ISOTROPIC\_PHASE\_CHANGE

This is thermal material property type 5. It allows temperature dependent isotropic properties with phase change to be defined. The latent heat of the material is defined together with the solid and liquid temperatures. The temperature dependency is defined by specifying a minimum of two and a maximum of eight data points. The properties must be defined for the temperature range that the material will see in the analysis.

Card 1            1            2            3            4            5            6            7            8

Variable	TMID	TRO	TGRLC	TGMULT				
Type	A8	F	F	F				

Card 2            1            2            3            4            5            6            7            8

Variable	T1	T2	T3	T4	T5	T6	T7	T8
Type	F	F	F	F	F	F	F	F

Card 3            1            2            3            4            5            6            7            8

Variable	C1	C2	C3	C4	C5	C6	C7	C8
Type	F	F	F	F	F	F	F	F

Card 4            1            2            3            4            5            6            7            8

Variable	K1	K2	K3	K4	K5	K6	K7	K8
Type	F	F	F	F	F	F	F	F

Card 5            1            2            3            4            5            6            7            8

Variable	SOLT	LIQT	LH					
Type	F	F	F					

<u>VARIABLE</u>	<u>DESCRIPTION</u>
TMID	Thermal material identification. A unique number or label not exceeding 8 characters must be specified.
TRO	Thermal density: EQ 0.0 default to structural density.
TGRLC	Thermal generation rate curve number, see *DEFINE_CURVE: GT.0: function versus time, EQ.0: use constant multiplier value, TGMULT, LT.0: function versus temperature.
TGMULT	Thermal generation rate multiplier: EQ.0.0: no heat generation.
T1 ... T8	Temperatures (T1 ... T8)
C1 ... C8	Heat capacity at T1 ... T8
K1 ... K8	Thermal conductivity at T1 ... T8
SOLT	Solid temperature, T <sub>S</sub> (must be < T <sub>L</sub> )
LIQT	Liquid temperature, T <sub>L</sub> (must be > T <sub>S</sub> )
LH	Latent heat

**Remarks:**

During phase change, that is between the solid and liquid temperatures, the heat capacity of the material will be enhanced to account for the latent heat as follows:

$$c(t) = m \left[ 1 - \cos 2\pi \left( \frac{T - T_S}{T_L - T_S} \right) \right] \quad T_S < T < T_L$$

Where

$T_L$  = liquid temperature

$T_S$  = solid temperature

$T$  = temperature

$m$  = multiplier such that  $\lambda = \int_{T_S}^{T_L} C(T)dT$

$\lambda$  = latent heat

$c$  = heat capacity

**\*MAT\_THERMAL\_ISOTROPIC\_TD\_LC**

This is thermal material property type 6. It allows isotropic thermal properties that are temperature dependent specified by load curves to be defined. The properties must be defined for the temperature range that the material will see in the analysis.

Card 1            1            2            3            4            5            6            7            8

Variable	TMID	TRO	TGRLC	TGMULT				
Type	A8	F	F	F				

Card 2            1            2            3            4            5            6            7            8

Variable	HCLC	TCLC						
Type	F	F						

<b>VARIABLE</b>	<b>DESCRIPTION</b>
TMID	Thermal material identification. A unique number or label not exceeding 8 characters must be specified.
TRO	Thermal density: EQ 0.0 default to structural density.
TGRLC	Thermal generation rate curve number, see *DEFINE_CURVE: GT.0: function versus time, EQ.0: use constant multiplier value, TGMULT, LT.0: function versus temperature.
TGMULT	Thermal generation rate multiplier: EQ.0.0: no heat generation.
HCLC	Load curve ID specifying heat capacity vs. temperature.
TCLC	Load curve ID specifying thermal conductivity vs. temperature.



**\*MAT\_THERMAL\_USER\_DEFINED**

These are Thermal Material Types 11-15. The user can supply his own subroutines. Please consult Appendix H for more information.

Card 1            1            2            3            4            5            6            7            8

Variable	MID	RO	MT	LMC	NVH	AOPT	IORTHO	IHVE
Type	A8	F	F	F	F	F	F	F

**Define the following two cards if and only if IORTHO=1**

Card 2            1            2            3            4            5            6            7            8

Variable	XP	YP	ZP	A1	A2	A3		
Type	F	F	F	F	F	F		

Card 3            1            2            3            4            5            6            7            8

Variable	D1	D2	D3					
Type	F	F	F					

**Define LMC material parameters using 8 parameters per card.**

Card 4            1            2            3            4            5            6            7            8

Variable	P1	P2	P3	P4	P5	P6	P7	P8
Type	F	F	F	F	F	F	F	F

<u>VARIABLE</u>	<u>DESCRIPTION</u>
MID	Material identification. A unique number or label not exceeding 8 characters must be specified.
RO	Thermal mass density.
MT	User material type (11-15 inclusive).
LMC	Length of material constants array. LMC must not be greater than 32.
NVH	Number of history variables.
AOPT	Material axes option of orthotropic materials. Use if IORTHO=1.0. EQ.0.0: locally orthotropic with material axes by element nodes $N_1$ , $N_2$ and $N_4$ , EQ.1.0: locally orthotropic with material axes determined by a point in space and global location of element center, EQ.2.0: globally orthotropic with material axes determined by vectors. LT.0.0: the absolute value of AOPT is a coordinate system ID number (CID on *DEFINE_COORDINATE_NODES, *DEFINE_COORDINATE_SYSTEM or *DEFINE_COORDINATE_VECTOR). Available in R3 version of 971 and later.
IORTHO	Set to 1.0 if the material is orthotropic.
IHVE	Set to 1.0 to activate exchange of history variables between mechanical and thermal user material models.
XP-D3	Material axes orientation of orthotropic materials. Use if IORTHO=1.0
P1	First material parameter.
.	.
.	.
PLMC	LMCth material parameter.

**Remarks:**

1. The IHVE=1 option makes it possible for a thermal user material subroutine to read the history variables of a mechanical user material subroutine defined for the same part and vice versa. If the integration points for the thermal and mechanical elements are not coincident then extrapolation/interpolation is used to calculate the value when reading history variables.

2. Option \_TITLE is supported
3. \*INCLUDE\_TRANSFORM: Transformation of units is only supported for RO field and vectors on card 2 and 3.

DRAFT